

This Owner's Manual is provided and hosted by [Appliance Factory Parts](http://www.appliancefactoryparts.com).



# Louisiana Grills LG700US Owner's Manual

[Shop genuine replacement parts for Louisiana Grills  
LG700US](#)



[Find Your Louisiana Grills Grill Parts - Select From 31 Models](#)

----- Manual continues below part list -----

## Available Replacement Parts for Louisiana Grills LG700US

<a href="#">50112</a>	Igniter Hot Rod only
<a href="#">50102</a>	Auger Motor 2 rpm
<a href="#">50133</a>	Fan CS Fan, LG Cooling Fan.
<a href="#">54402</a>	Thermometer Dome LG

**WORLD CLASS BBQ**  
IN YOUR  
**OWN BACKYARD**



# Owners Manual

You **MUST** read this manual before operating your grill!

**LG700**  
**LG900**  
**LG1100**



"Please read the entire manual before installation and use of this pellet fuel-burning appliance. Failure to follow these instructions could result in property damage, bodily injury or even death."  
Contact local building or fire officials about restrictions and installation inspections required in your area.

**WWW.LOUISIANA-GRILLS.COM**

**1-877-303-3134**  
**CUSTOMER SERVICE**

# Dangers & Warnings

**“A MAJOR CAUSE OF FIRES IS FAILURE TO MAINTAIN REQUIRED CLEARANCES (AIR SPACES) TO COMBUSTIBLE MATERIALS. IT IS OF UTMOST IMPORTANCE THAT THIS PRODUCT BE INSTALLED ONLY IN ACCORDANCE WITH THESE INSTRUCTIONS.”**

## **WARNING:**

**DO NOT touch any part of your “LG Series Smoker” while the smoker is HOT. Serious bodily injury could result.**

- Keep the entire grill a minimum 12 inches, or a safe distance, from all combustibles.
- Do not install or operate grill under a combustible ceiling or overhang.
- Do not enlarge burn grate orifices, igniter holes or burn pots
- LG Smokers should be cleaned and maintained on a regular basis
- After a period of storage, and/or non-use, the Louisiana Grill Smoker should be checked for burn grate obstructions, foreign objects both inside the grill and the hopper, and air blockage, before use. See instructions in this manual for correct procedures
- Do not put a barbeque cover or anything flammable on, or in the storage space area under the barbeque.
- Children should never use your LG Smoker barbeque while unattended. Accessible parts of the barbeque may be very hot. Keep young children away while it is in use.
- Do not use lava rock, wood chucks or charcoal in your Smoker.
- Do not use accessories not specified for use with this appliance
- Never lean over open grill or place hands or fingers on the front edge of the cooking box or in the hopper.
- Should a grease fire occur, turn “Off” the control and leave lid closed until the fire is out. DO NOT unplug the power cord. DO NOT throw water on it. DO NOT try to smother the fire.

## **WARNING:**

**DO NOT transport your “LG Series Smoker” while operating or while the grill is HOT.**

- DO NOT use your grill in the rain or around any water source.
- Always unplug the grill before performing any service or maintenance .
- If the LG Smoker is stored outside during the rainy season or seasons of high humidity, care should be taken to insure that water does not get into the pellet hopper. Wood pellets, when wet or exposed to high humidity, expand greatly, break apart, and could jam the feed system.
- Disposal of ashes— Ashes should be placed in a metal container with a tight-fitting lid. The closed container of ashes should be placed on a non-combustible floor or on the ground, well away from ALL combustible materials, pending final disposal. When ashes are disposed by burial in soil or otherwise locally dispersed, they should be retained in the closed container until all cinders have thoroughly cooled.

**It is a highly recommended practice to always go through the basic SET-UP Procedures after every 1 to 2 cooking's. This will ensure proper ignition, heat output and many happy grilling experiences.**



*Savor the Flavor!*

# Dangers & Warnings

## WARNING:

**DO NOT over-fire your “LG Series Smoker”. Improper Use Can Cause Uncontrolled Fire.**

### FUEL—WOOD PELLETS

- This pellet cooking appliance is designed and approved for pelletized, all natural, wood fuel only. Any other type of fuel burned in this appliance will void the warranty and safety listing.
- Use only all natural wood pellets, designed for burning in grills.
- Do not use fuel labeled as having additives.
- At this time of printing, there is no “Standard” for BBQ wood pellets, although most pellet mills do use the same standards used to make “Home Heating” wood pellets. Further information on this “Standard” can be found at [www.pelletheat.org](http://www.pelletheat.org) or the Pellet Fuel Institute.
- Check with your local dealer on the quality of pellets in your area and for information on what can be expected from various brands.
- NOTE: Since Dansons Inc. has no control over the quality of pellets, that you use, we assume no liability caused by the quality of fuel used.

### CREOSOTE

- Do Not operate the appliance if the flame becomes dark and sooty or if the burngrate overfills with pellets. Push the OFF touch pad, let the appliance cool completely, and then inspect the unit. Soot or Creosote may accumulate in the main barrel and along any air leakage or exhaust areas when the appliance is operated under incorrect conditions, such as incorrect burn grate position, blockage of the combustion fan, failure to clean and maintain the burn area, etc.
- Soot or creosote is formed when pellets are burned without the correct amount of air to fuel, or incomplete combustion, thus producing a tar like substance and other organic vapours that combine with expelled moisture. The smoke will have a black color to it and the residue left behind on surfaces, will also be black in color.
- When ignited, this creosote makes an extremely hot and out of control fire, similar to a grease fire.
- If creosote has formed within the unit; allow the unit to warm up at a LOW temperature, turn OFF the appliance, then wipe out any formation with a hand towel. Creosote is similar to tar, when warmed it will begin to run, become like liquid, and is easier to clean in this state.
- Should a grease or creosote fire occurs, turn “Off” the control and leave lid closed until the fire is out. DO NOT unplug the power cord.

## WARNING:

**IF A UNCONTROLLED FIRE DOES OCCURE: CALL FIRE DEPARTMENT.  
DO NOT: try to move appliance, try to smother the fire, or put water on the fire.**

### CARBON MONOXIDE: “The Silent Killer”

FOLLOW THESE GUIDELINES TO PREVENT THIS COLORLESS, ODORLESS GAS FROM POISONING YOU, YOUR FAMILY OR OTHERS:

- Know the symptoms of carbon monoxide poisoning: Headaches, Dizziness, Weakness, Nausea, Vomiting, Sleepiness, and Confusion. Carbon Monoxide reduces the blood’s ability to carry oxygen. Low blood oxygen levels can result in loss of consciousness and death.
- See a doctor if you or others develop cold or flu-like symptoms while cooking or in the vicinity of the appliance. Carbon monoxide poisoning, which can easily be mistaken for a cold or flu, is often detected too late.
- Alcohol consumption and drug use increase the effects of carbon monoxide poisoning.
- Carbon monoxide is especially toxic to mother and child during pregnancy, infants, the elderly, smokers, and people with blood or circulatory system problems, such as anemia, or heart disease.

*Savor the Flavor!*

**WORLD CLASS BBQ**  
**IN YOUR**  
**OWN BACKYARD**



# WORLD CLASS BBQ IN YOUR OWN BACKYARD

Dear "Louisiana Grill" Wood Pellet Barbecue Owner:

**Thank you for choosing to purchase a "Louisiana Grill Series" wood pellet smoking' grill.**

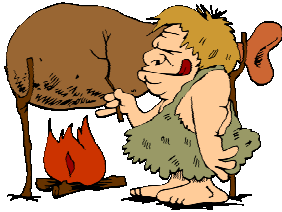

Cooking with your Louisiana Wood Pellet Grill is about to bring you full circle from the days of the caveman when cooking outdoors with wood was a necessity, to cooking indoors in your modern kitchen and now back to the great outdoors and that savory wood flavor.

Think of your "Louisiana Grill" as an extra stove available to bake, roast, grill, sear and smoke food. Anything that can be done in your indoor kitchen can be done on your grill.

Barbecuing is a culture all on its own. Barbecuing provides a form of entertainment, which is relaxed and casual. Your meals can be completely cooked outdoors and the chef is one of the crowd. Keep it simple, be creative, and have some fun.

We'd like to take this opportunity to pass on a few **important tips** concerning grilling with wood pellets.

- **Initial set-up of your "Louisiana Grill" is the most important step** to ensure the efficient and satisfactory operation of your barbecue for many years to come.
- **Be diligent in your cleaning and maintenance program.** Taking care of your grill will add years of life and keep it looking great.
- Use only all natural wood pellets designed to burn in pellet grills.
- Ensure your pellet fuel stays moisture free. Open bags of fuel should be stored in an airtight container and empty the hopper if you are not using the grill over longer periods.

Our loyal staff, valued customers, friends and our loving families have all contributed recipes to our cookbook. We have tried to include a broad range of cuisines and styles, starting with Mom's Great Home Cooking and many, many, many, catering and entertaining experiences to current classics and new soon to be classics.

## WE WANT YOU!

If you are interested in contributing a family favourite or competition winner, or any recipe, (especially if it contains bacon) please share it with us.  
Fax: 1-877-303-3135, Web [www.louisiana-grills.com](http://www.louisiana-grills.com), Email: [sales@dansons.com](mailto:sales@dansons.com)  
or Snail Mail: to the address below.

Now go, fill up the hopper, light up that grill and get ready to enjoy

**World Class BBQ In Your Own Backyard!**

Again, we want to say THANK-YOU for your purchase

Staff and Management  
Dansons Inc.



### COPYRIGHT NOTICE

Copyright 2014,  
All rights reserved.

No part of this manual may be copied, transmitted, transcribed, stored in a retrieval system, in any form or by any means without the expressed written permission of,



**Dansons Inc.**  
14608—134th Ave., Edmonton, AB, Canada T5L 4T4

# Contents

DANGERS & WARNINGS	2
SAFETY TESTING	6
UNPACKING YOUR LG SMOKER	6
<b>ASSEMBLY INSTRUCTIONS</b>	
Leg Assembly & CASTERS	8
SERIES 4C HOPPER ASSEMBLY	10
BURN Grate, IGNITER	12
FLAME BROILER, HANDLE, THERMOMETER	13
GRIDS, BUCKET & POWER	14
<b>KNOWLEDGE IS POWER</b>	
HOW YOUR LG SMOKER WORKS	15
SPECS	16
ARCHED FLAME BROILER	17
IGNITER	17
BURN POT & BURN GRATE	17
AUGER FEED	17
DIGITAL CONTROL CENTER	18
HOPPER	19
POWDER COAT FINISH	19
COOKING GRIDS	19
GREASE BUCKET	19
ABOUT WOOD PELLETS	20
<b>OPERATION</b>	
SET-UP PROCEDURE	21
GETTING STARTED	22
LIGHTING - AUTOMATIC / MANUAL	23
PROGRAMMABLE MEAT PROBE	24
SHUTTING OFF YOUR SMOKER	26
<b>MAINTENANCE</b>	28
<b>GRILLING TIPS AND TECHNIQUES</b>	29
<b>TROUBLE SHOOTING</b>	32
<b>PARTS LIST</b>	35
<b>LIMITED WARRANTY</b>	36

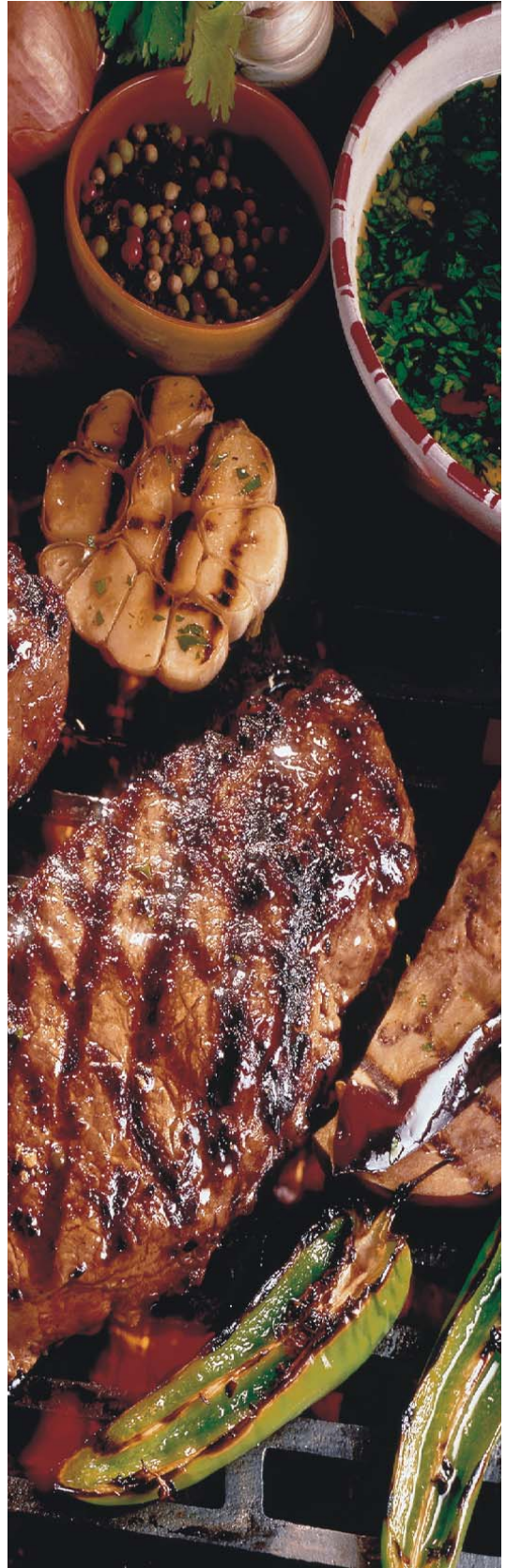

# Unpacking Your LG Series Smoker

## IMPORTANT NOTICE

- \* Be sure to inspect the entire grill after removing the protective shipping carton.
- \* Report any damage to your local dealer immediately.
- \* Shipping damage is not covered under warranty.



## Opening the top of the shipping crate

When you opened the top of the protective shipping carton you found the unit covered in a protective cover bag, 2 protective Styrofoam fillers and a "Quality Control Checklist".

**A**



**WARNING!** Please discard the plastic bag properly and in a timely matter, as it can be dangerous and can lead to suffocation.

## Tip !

Staple your "Quality Control Checklist" to the inside of this Owners Manual



## Quality Control Checklist (diagram B)

The team at Louisiana Grills take pride in what we manufacture and sell. This checklist is our way of ensuring every Country Smoker we make is complete when you open it.

It also contains the Model and Serial Number you will need when you communicate with your local Authorizer Louisiana Grill Dealer or Dansons.

**B**

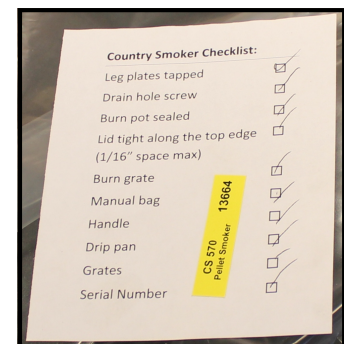

## Removing the Country Smoker (diagram C)

The protective cardboard shipping crate makes the perfect protective material while assembling your Country Smoker.

Using a sharp utility knife, simply cut carefully down both sides of the front of the box, from the top to bottom. This will give you easy access to remove the contents from inside the barrel.



# Unpacking Your LG Series Smoker

When you open your smoker/grill, please ensure you have and can identify all the following parts:

**NOTE:** Numbers following parts names throughout this manual refer to the component diagram below.

## Items found in the box

1. Burn Pot— Installed and sealed
2. Burn Grate—Stainless Steel
3. Arched "Flame Broiler" - 2 pc.
4. Series 4 Hopper w/Digital Control Center
  - A. Grill Probe (installed)
  - B. Programmable Meat Probe
5. Grease Bucket
6. Stainless Steel Handle Assembly
  - Washers, large and small X 2
  - #250 x 5/8" Threaded Multi-Head Screws X 2
7. Porcelain Cast Iron Cooking Grid (s)
8. Porcelain Upper Cooking Grid

## Items found in the parts bag

### Wheels and levelers

9. 6" Diameter Wheels X 2
  - Wheel Axles X 2
  - #3 Hitch Pins X 2
  - Fender Washers X 2
10. 3" Diameter Casters X 2

### Mounting Hardware—Hopper to Barrel

- 6 x # 180 x 3/8" Black Multi-head Machine Screws
  - 4 for mounting hopper to barrel
  - 2 for mounting igniter to hopper

### 26 x # 250 x 3/8" Multi-Head Machine Screws

- 24 for Leg Assembly

### Dome Thermometer

- Large Finishing Washer
- Large Felt Spacer
- 9/16" Nut and Washer

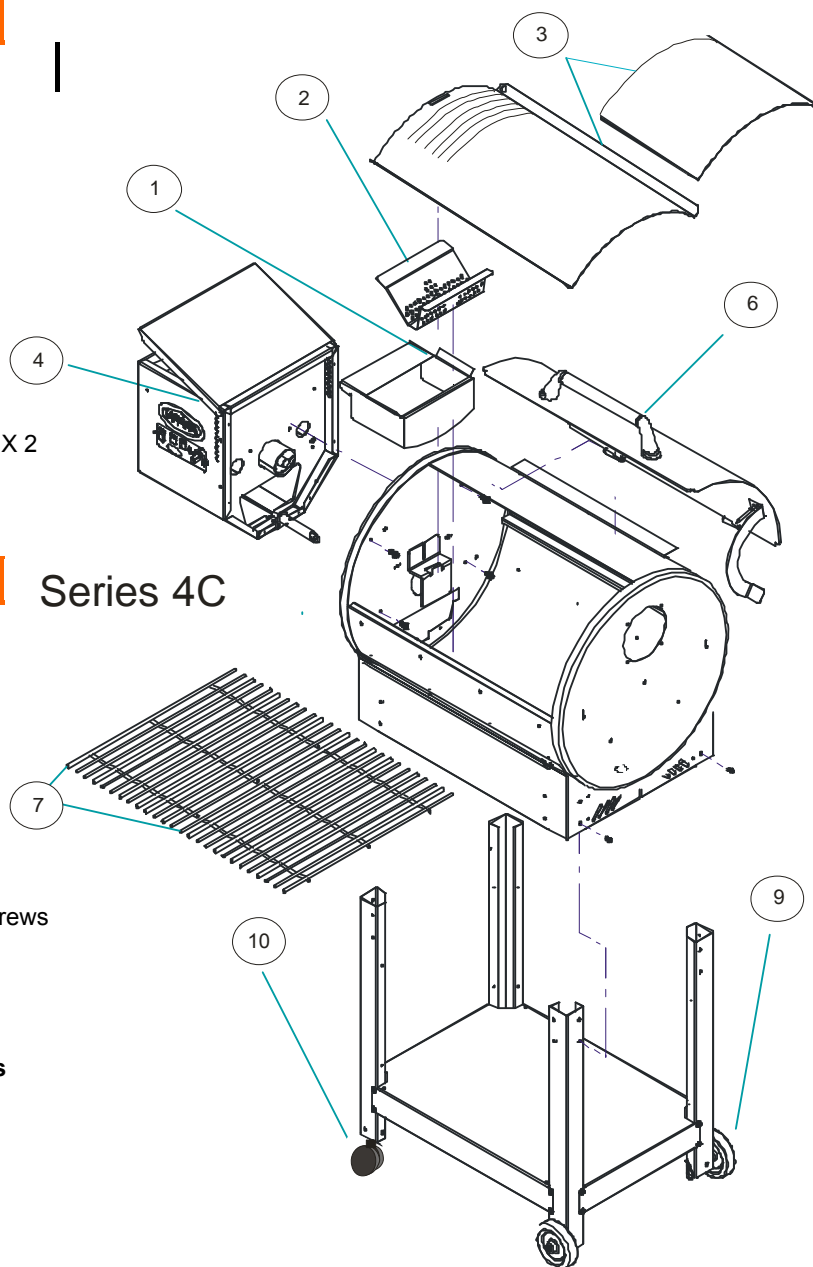

## Printed Material

- Owners Manual
- Cooking Guide—40 page



# Assembly Instruction

## INSTALLING THE CART KIT

### Parts Included:

- 2 x 21" long legs
- 2 x 23" long legs
- 2 x 6" Wheels
  - 2 axles
  - 2 cotter pins
  - 2 washers
- 2 x 3" Threaded Casters
- 24 x Multi-head machine screws

### Tools Required:

Large Phillips Screwdriver or  
Phillips Drive Bit and Drill

### Installation:

#### Step 1 Attach legs to bottom shelf

The bottom portion of each of the 21" legs has a threaded plate installed to allow for 2 casters to be installed. The 2 x 23" legs have holes punched through to accept the wheel axles.

- To ease installation, assemble leg components and shelf upside down. The shelf mounting holes being on top.
- Ensure that the shelf is facing with the flat surface facing downwards toward your working surface.
- Using a Phillips head driver, install 4 of the supplied screws into each leg, to secure each leg to the shelving unit.

**NOTE: It is best to start each threaded screw by hand, to ensure the thread DOES NOT cross thread or strip.**

- Ensure that ALL screws are firmly, hand-tight, secured.

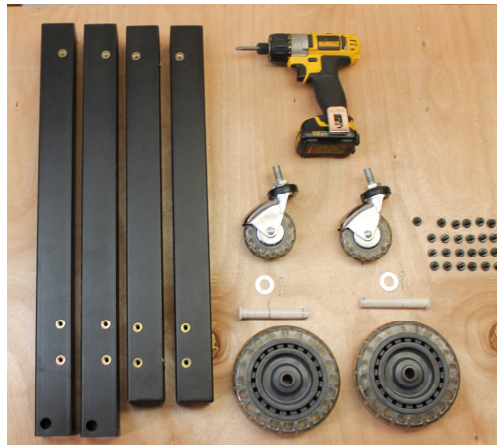

1 Bottom Shelf



Shelf Mounting  
Holes

Barrel Mounting  
Holes

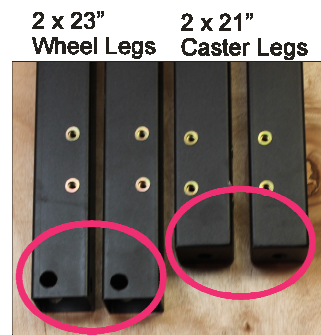

Axle Holes

Threaded  
Caster Holes



Multi-Head  
Machine  
Screws

# Assembly Instruction

## INSTALLING THE CART KIT ...CON'T

### Step 2 Install the Casters:

The bottom portion of each of the 21" long legs has a threaded plate installed to allow for the installation of a thread caster.

You will use both Threaded Casters.

- Hand install the casters on the 21" (shorter of the two) legs.
- Using your 1/2" wrench, turn each of the casters in a clockwise direction into the bottom leg plate. Turn ALL the way in.



### Step 3 Install the Wheel Assemblies

Each 23" long leg has a solid bottom plate, as well as a hole punched through the leg to accept a wheel axle.

You will use both Wheels, 2 x Axels, 2 x Fender Washers and 2 Cotter Pins

- Install the wheel assemblies on the 23" (longer of the two) legs.
- Insert the axle through the wheel, the leg assembly and finally the fender washer. The wheel should be on the outside edge of the assembly, next the leg and then finally the fender washer.
- Insert the hitch pin clip through the hole found at the end of the axel.

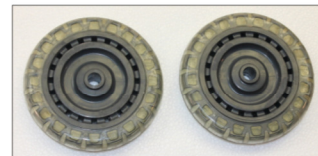

### Final Step Attaching the Cart to the Barrel

- Ensure that when you install the Barrel Smoker onto the Leg Cart that the Caster Legs are on the hopper end of the grill. This will give stability to completed unit and allow for easy movement.
- Carefully lift the Barrel Smoker up and onto the Leg assembly.  
**Note:** This may require 2 people.  
The Barrel Smoker will slide down and over the leg assembly .
- Starting at one leg:  
Line up the pre-drilled and cinch nut installed holes on the leg, See diagram for location, and the punched hole on the side of the smoker. There is one on the front and one of the side of each leg.
- Using a Phillips head driver, install 2 of the supplied screws into each leg, to secure each leg to the Barrel.

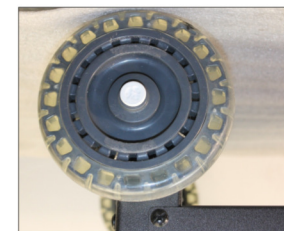

**NOTE: It is best to start each threaded screw by hand, to ensure the thread DOES NOT cross thread or strip.**

- When one leg is complete, continue the same steps  
On the remaining 3 legs.

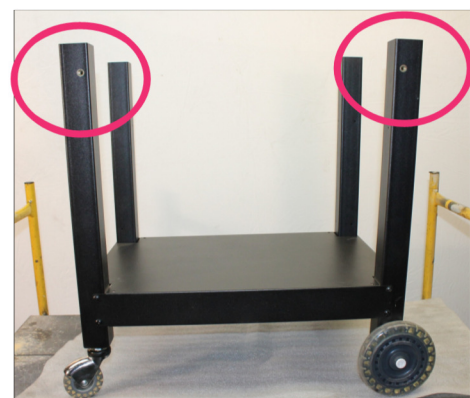

# Assembly Instruction

## Installing the Hopper and Grill Probe

### Parts Included:

Series 5C Hopper Assembly  
Mounting hardware  
2 x #10 x 16 x 1/2" screws,  
4 x 1/4 x 20 x 1/2" screws



### Tools Required:



Phillips Screw Driver Bit

Phillips & Standard  
Screwdrivers

Cordless Drill



### Installation:

#### Step 1 Attaching the Igniter to the Hopper:

- Carefully remove the igniter and its packaging from inside the hopper. **Diagram A**
- Using your Phillips Srewdriver and the 2 (two) #180 x 3/8" screws, secure the Igniter to the hopper outside of the hopper. **Diagram B**

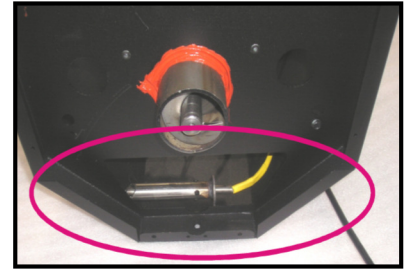

A

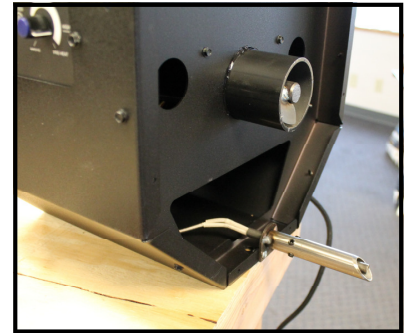

B

#### Step 2 Attaching the Grill Probe Wires:

Your Grill/Smoker comes complete with the "Digital Control Center" complete with grill probe and meat probe. The grill probe has been factory installed in the barrel, with the excess wire and connections run out through the barrel end and threaded into the auger feed hole, for shipping reasons. **Diagram C**

The wire connections to the board can be found in or taped to the outside of the hopper. **Diagram D**

- To connect, carefully lift the entire hopper and attached igniter, to the left handside of the main barrel.

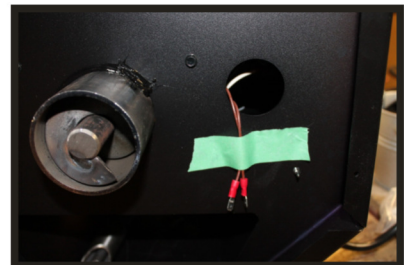

C

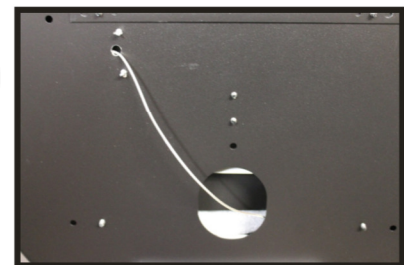

D

- Begin by slightly inserting the igniter into the installed Burned Pot at the bottom side of the barrel. Support the hopper on your leg as you connect the two spade connections. **Diagram E**



E

- Carefully thread ALL excess wire, as well as the connections, back into the hopper. The wiring must not come in contact with either the fan blades, or the metal auger tube. **Diagram F**



F

# Assembly Instruction

## INSTALLING THE HOPPER, IGNITER & PROBE WIRE

### Step 3 Attaching the hopper to the barrel:

- The mounting bracket on the rear of the hopper (B) must be raised slightly higher than the receiving bracket on the barrel. (A)  
**Diagram A & B**
- Begin by slightly inserting the igniter into the installed Burned Pot at the bottom side of the barrel.  
Next slightly insert the Auger Feed tube into the correct hole.  
It might be necessary to raise the hopper slightly to ensure the mounting bracket on the hopper will go over the receiving bracket on the barrel.
- Push Hopper tightly against the main barrel.  
Next holding the hopper fairly level, press downward to clip the hopper onto the mounting bracket. **Diagram C & A**
- Using your 5/16" nut driver or standard screwdriver and the 4 1/4x20-1/2" hex screws, secure hopper to barrel through the holes provided, inside the barrel. **Diagram D**

**NOTE: If the holes do not line up, the hopper may need to be fully clipped into place.**



**A**



**B**



**C**

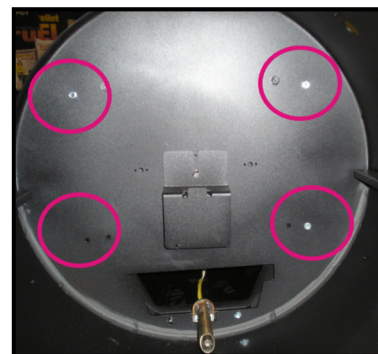

**D**

# Assembly Instructions

## POSITIONING THE BURN GRATE:

**Tip !** The placement of the burn pot and burn grate is VITAL to a happy and full range cooking experience!



Confirm the positioning of the Burn Pot Diagram A

- Confirm that the back of the burn pot has been pushed tight, into the hopper and against the end wall of the grill ( A & B).
- Confirm that the burn pot has been sealed with high temp caulking around the inside of the barrel end.

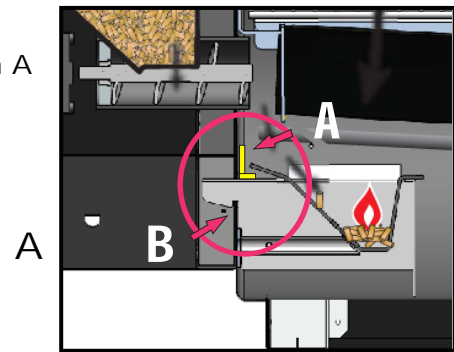

Install the Burn Grate Diagram B

- The larger lip of the grate installs under the pellet fuel deflector (A)
- The front lip of the burn grate should be sitting flush along the top of the burn pot . (C)
- The bend at the rear of the grate should also be sitting tight to the back of the burn pot. (B)

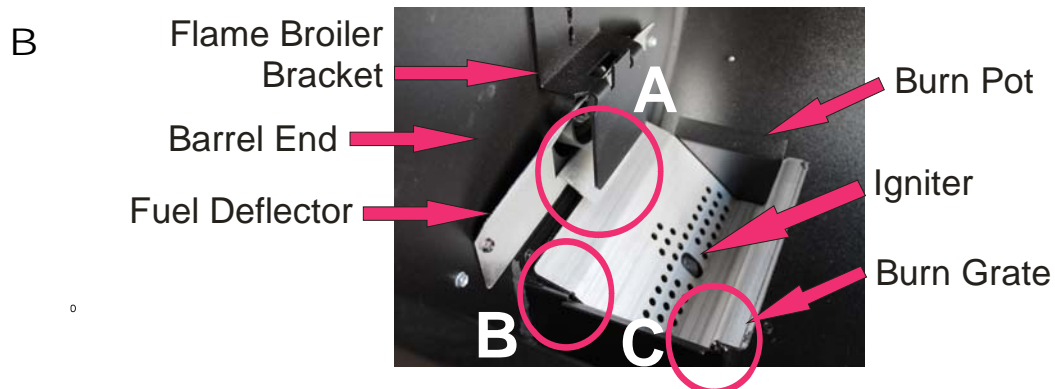

## POSITIONING THE IGNITER:

Confirm the positioning of the Igniter Diagram C

It is extremely important to have the igniter and the igniter hole in the burn grate line-up.

The burn grate should not be sitting on top of the igniter or the hot rod.

It may be necessary to remove the burn grate, then gently holding onto the igniter assembly, gently lift or lower the igniter until it lines up properly.

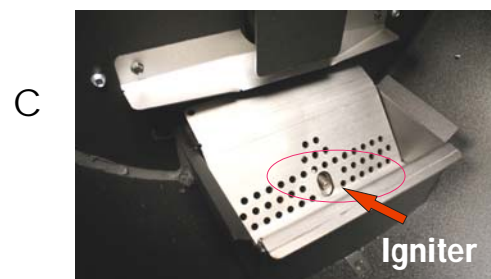

# Assembly Instructions

## INSTALLING THE “ARCHED FLAME BROILER”:

- To ensure proper height, the bottom of the mounting bracket (A) should not be within the pellet drop chute area. If you do need to adjust the bracket, loosen off the 2 (two) Phillips screws, lift the bracket and re-tighten the screws.
- Take the Arched Flame Broiler (C) and hold it so that the end with the cut out and slots is in your left hand. The plate then clips easily over the adjustable mounting bracket. (B)
- Take the Arched Flame Broiler Cover Plate (D) and place it on top of the main piece (C). This plate is used to slide over the flame broiler opening, to open or close “Direct” flame searing.

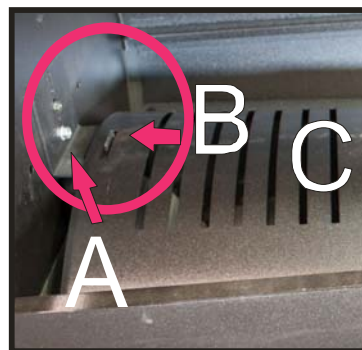

## INSTALLING THE HANDLE:

### Tools Required:

Phillips Screw Driver  
Cordless Drill & Phillips Bit

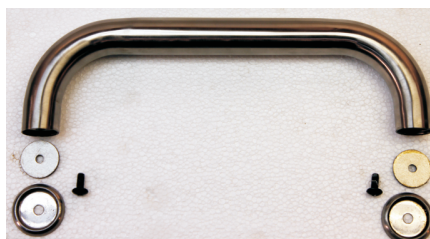

- Insert one screw through the hole provided in the barrel
- Install the LARGE Decorative Washer, then the smaller washer on the screw end sticking through the barrel.
- Hand thread and tighten this screw to one of the ends of the one piece stainless steel handle. .
- Follow the same procedure to secure the other end of the handle to the barrel.
- Using a screw driver firmly tighten both bolts until handle feels firm.

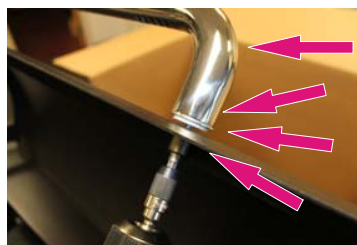

Handle  
Small Washer  
Large Decorative Washer  
#250 5/8"  
Machine Screw

**CAUTION!** DO NOT OVERTIGHTEN! Only a snug fit is required.

## INSTALLING THE THERMOMETER:



9/16" Wrench

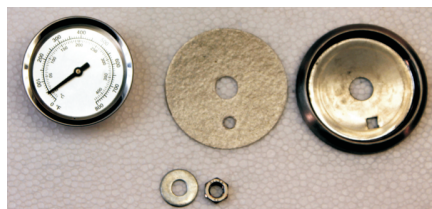

Dome Thermometer  
Large Protective Felt  
Large Finishing Washer  
Washer & 9/16" Nut

The thermometer comes complete with its own threaded nut already installed on the thermometer.

- Simply spin off the threaded nut and small washer.
- Insert the Dome thermometer, along with the large finishing washer as well as the protective felt, through the hole provided in the top of the hood,
- Then firmly hand tighten the nut back onto the thermometer.



# Assembly Instructions

## INSTALLING THE PORCELAIN COATED GRIDS:

Your LG SERIES Smoker comes complete with 2  
Porcelain Coated Cast Grids for the Main cooking surface.

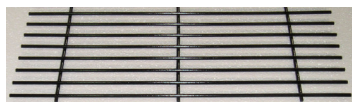
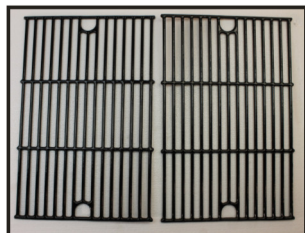

Your LG SERIES Smoker comes complete with 1  
Porcelain Coated Grid for the Upper Cooking Rack.

- NOTE: To maintain the searing and grilling performance of your grid, as well as their longevity, some

## INSTALLING THE GREASE BUCKET:

Simply place the handle of the bucket into the  
slot of the grease drop chute (11).

- NOTE:** any metal bucket and any size could also be used.  
Ensure that the handle can safely clip into the  
slotted grease drop.

**Tip !** After installing the bucket on the grease drop chute, install  
a #3 Hitch Pin up through the drop chute. This will secure the  
bucket handle and avoid those accidental bucket spills.



## HOOKING UP TO POWER:

### AT HOME

- This appliance requires 110 Volt, 60Hz, 5amp service.
- It must use a 3 prong grounded plug.
- Both the “Deluxe Temperature Control” and “Digi-Que” controls use a 5 amp fuse to protect the board from the igniter.



### GFI Outlets

- This appliance will work on most GFI Outlets. Recommended size 15 amp.
- If your GFI outlet is highly sensitive to power surges, it will very likely trip during the ignition phase of operation. During the ignition phase, the igniter is drawing 300—700 watts of electricity which can be too much power for a GFI outlet to handle. The quality of the GFI does not matter, rather the sensitivity matters. Each time a GFI trips it does increase in sensitivity.

- Solution:** 1. Install a brand new GFI .  
2. Plug the appliance into a non-GFI outlet.



### ON THE ROAD

- By disconnecting the Igniter, from the main wiring harness, your Country Smoker can be run using a 12 volt , 100 watt inverter plugged into your automobile outlet. Then light your smoker using the manual method. ( found in lighting instructions)
- If you do want to continue to use the automatic igniter, it is recommended to use a minimum of a 1000 watt inverter.



# Knowledge is Power

## How Your LG Smoker Works 101

- The perfect barbecue experience starts with filling your hopper (2) with all natural wood pellets.
- Press the “START” touch pad (18), this activates the “Fan” (6) which is used to cool the hopper (2), cause the pellets to burn (8) and results in convection cooking (14). It also activates the electronic Auto Igniter (7), and the pellet feed system (3,5).
- A motorized Auger Motor (5) and Metal Auger Shaft (3), deliver the pellets to the burn grate (8). Your Country Smoker uses “Top Feed” technology, which means the Auger (3,5) delivers the pellets up above the burn grate (8) and then the fuel drops into the burn grate. The strength of the auger motor (5), the metal shaft (3) and the open design reduce the possibilities of “jams” and allows for the use of less than premium quality fuel.
- Adjusting the temperature setting on the “Digital Control Center” Board (18) sets the speed of the feed, thus the temperature output. This control is fully adjustable, from hot smoke 170° F to 600° F searing and shows both “Desired” and “Actual” grill and meat probe temperature readings.
- The “Electronic Auto Igniter” (7) activates until the unit reaches 150°F, igniting the pellets in the burn grate (8).
- The Combustion / Cooling fan (6) cools the hopper (16); provides combustion air to the burn grate (8); and causes air movement in the cooking area (14), resulting in convection cooking.
- The fuel burns in the burn grate (8) hot and intense, somewhat like a forge. The fly ash is directed downward by the “Arched Flame Broiler” (12) and can be cleaned out periodically from inside the bottom of the barrel.
- A CLOSED “Arched Flame Broiler” (12) protects the food from direct contact with the flame; gives a large hot metal area to help evaporate the juices back into the cooking resulting in added flavor; channels excess grease directly to a grease pail (11); and distributes the heat evenly throughout the cooking area.
- The natural smoke flavor produced by the burning pellets, the “Arched Flame Broiler” (12) and the fan induced “Convection Cooking” (14) combine to give you the savory flavor and even cooking that is unique to pellet grills and will win you rave reviews each time you use it.

**TIP** Your LG Smoker Grill can run efficiently over extended periods of time and at different heat output levels, as long as the fuel supply is dry, uninterrupted and timely cleaning and maintenance is performed.



### Standard Features

#### Powder Coat Finish

1. Hopper Lid
2. 14lb. Hopper
3. Metal Auger Feed
4. Stay Cool Handle
5. Feed Motor
6. Combustion / Cooling Fan
7. 300 Watt Electric Igniter
8. Stainless Burn Grate
9. Sealed Burn Pot
10. Heavy Duty Steel Tube Legs
11. Grease Bucket
12. Arched “Flame Broiler”
13. Porcelain Cast Cooking Grids
14. Convection Cooking Chamber
15. Dome Thermometer
16. Air Cooled Vented Hopper
17. Convection Air Exhaust
18. Digital Control Center
19. Solid Bottom Shelf
20. Wheels
21. Casters

### Series 4C Pellet Smokers/Grills

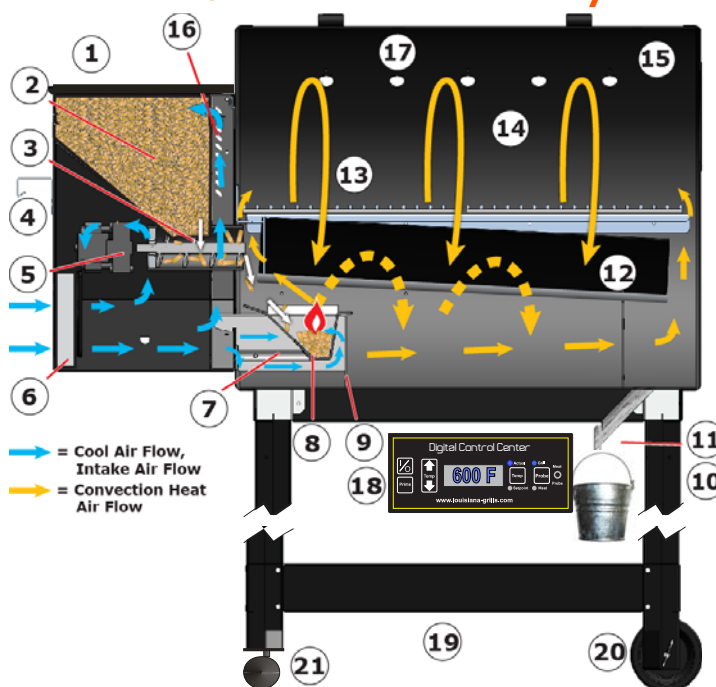

# Knowledge is Power

## Your New **LG SERIES 700, 900 & 1100** Wood Pellet Fired Smokin Grills

Large **14lb. Hopper** capacity  
Easy flip up top, with rounded edges

Time proven **Metal Auger Feed System**

Fan Forced Combustion,  
Cooling and  
Convection Cooking.

**“Digital Control Center”  
w/ Programmable Meat Probe**

Electric Igniter eliminates the  
need for matches & starter  
fluids.

Full Range Oven Temperature  
170 to 600 degrees, giving more  
cooking options; hot smoking to  
searing.

Primer Button aids in  
quicker heat recovery or  
increasing smoke intensity.



Dome Thermometer

Stainless Steel  
Handle to open lid

14 Gauge Steel Construction

**Not Seen**

**Porcelain Cast Iron**

**Cooking Grids**

**Upper Cooking Rack**

Heavy-duty engineered  
Legs and Shelf frame

Casters

6" Dia. wheels

MODEL	UNIT	COOKING AREA	ELECTRIC	SIZE H X W X D	WEIGHT
<b>LG</b>	<b>700</b>	<b>707</b> sq. in. TOTAL	110 Volt 60Hz 5 Amp 3 prong grounded plug 15 amp GFI	43 x 39.5 x 23	122 lbs..
<b>LG</b>	<b>900</b>	<b>913</b> sq. in. TOTAL	Same	43 x 45 x 23	140 lbs.
<b>LG</b>	<b>1100</b>	<b>1061</b> sq. in. TOTAL	Same	43 x 51 x 23	159 lbs.

### OPTIONS



#### **Hopper Extension**

Easy add-on w/ lid  
Adds extra 20 lbs.

#### **Cold Smoker Attachment**

5 pullout shelves  
Can add additional  
5 shelves  
Cold Smoker or  
Warming Oven

#### **Deluxe Front Shelf**

12" D x 24" W  
Clip-on Flip Down  
Stainless Steel Finish

#### **Clip-on Flip Down Side or Front Shelf**

12" W x 14.5" D  
Powder coat or Stainless Steel  
finish with tool hang-

#### **Cart Enclosure Kit**

2 swing open doors  
2 side panels  
1 rear panel  
Stainless Steel or  
Powder Coat Finish

#### **Custom Cover**

Silk Screened heavy duty 600 danier,  
polyester canvas, double stitched,  
Polyurethane interior, tightening strap.

# Knowledge is Power

## Arched Flame Broiler



Unique Feature

All LG Smoker models come with a 14 gauge “Arched Flame Broiler”, designed to withstand high temperature and give years of performance. The Arched Flame Broiler, when closed, has been designed to keep the flame out of direct contact with your cooking surface, thus helping to reduce the chance of flare-ups. The arched design increases the amount of hot surface area to allow more fats and juices from the meats to evaporate a smoke flavor, back into meat. As well you will note the bent edges running down the length of the back and front of the angled, arched steel, these are to help in channeling the excess grease directly to the one end of the smoker where it is then allowed to collect in a convenient removable pail. The unique design also directs the majority of fly ash down toward the bottom of the barrel, while allowing for the fan forced heated air to circulate around the barrel causing convection cooking. Sliding the Flame Broiler OPEN allows for “Direct Flame” cooking and temperatures as high as 1000 F. This is used to “Flame Kiss” or broil steaks, roasts, or vegetables.

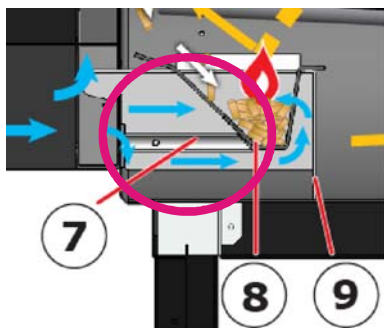

## Automatic Igniter (#7)

The 300 watt electric igniter eliminates the need for messy starter fluids or gels. It is safe and easy to start, even the little beginner “Pit Master” can start a LG Smoker. The igniter is simply a hot rod encased in a stainless steel holder. This style of igniter has been used throughout the pellet stove industry for years. The combustion/cooling fan blows air into the back of the igniter assembly, surrounding the hot rod. Then the super heated air exits through the open end, near the back of the burn grate. As the pellets begin to heat up they eventually break out in flames, this is known as spontaneous combustion. The igniter will stay activated for 7-15 minutes. If for any reason the igniter fails, you can start the grill manually.

**NOTE:** The igniter can be disconnected, to allow your LG smoker to run with a minimum 100 watt inverter. (see manual starting procedures, further in this manual.)

## Burn Grate (#8)

The burn grate is constructed out of stainless steel and is the heart of your grill. The burning temperature in the grate can reach temperatures of 1700 to 2000°F. The air holes are designed to allow the right combination of fan forced air to force the wood pellets to burn hot and clean while grilling or allow them to smolder and produce the savory smoke while in the smoke temperature. The back of the burn grate has a large oblong hole in the back to allow the hot igniter air to come through, causing the pellets to catch fire.

**NOTE:** The burn grate should be checked after every MAJOR use to ensure that the combustion air holes are not clogged and to ensure the igniter hole is clean.

## Burn Pot (#9)

The burn pot is used to hold the Burn Grate, the igniter assembly, and to channel the fan forced combustion air. The pot has been designed to be moved easily to aid in cleaning and replacement of the igniter. **It is very important that the burn pot is seated and secured properly in order to ensure proper combustion and heat output.** The burn pot needs to be pushed in tightly against the side of the barrel, and secured with a screw into the bottom of the barrel (see installing the burn pot and diagram).

Ensure that there is no foreign matter under the burn pot that may lift it off the bottom of the barrel. This will allow combustion air to leak out, thus reducing the heat output of your grill.

## Auger Feed System

The heart of the feed system is a time proven, metal auger (4) and high torque auger motor (5). This combination allows for different quality of pellet fuels to be used while reducing the possibilities of “jams” taking place. The metal auger design also helps in maintaining a constant and even feed of the fuel to the fire, resulting in better and consistent temperature control. The Auger Feed System is run by a 2 rpm motor. (see control board, Digital Control Center, for further information).

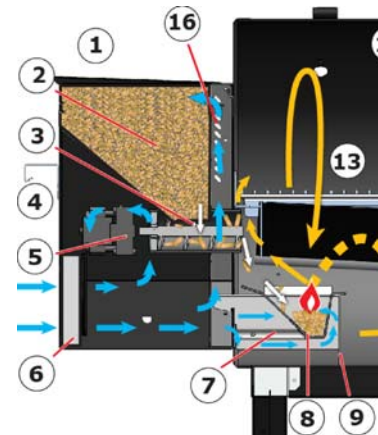
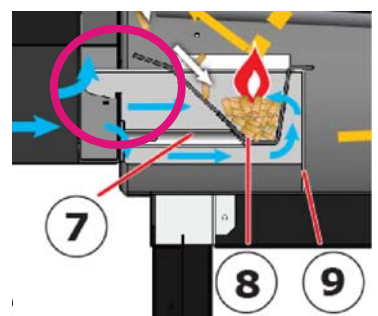
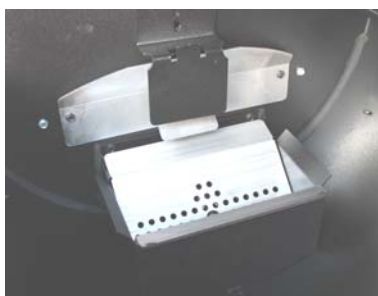

# Knowledge is Power



## Digital Control Center

This control is very much the same as the control on your kitchen oven. The main advantages are the ability to automatically compensate for the different ambient conditions and fuel types allowing for longer, carefree bbq as well as the Programmable Meat Probe function.

**Remember:** Much like your kitchen oven, the ACTUAL temperature does fluctuate up and down depending on weather, the flavor of pellets being used, and the amount of food on the grill.



### ON / OFF TOUCH PAD

This pressure sensitive touch pad is used to turn the control "ON", which initiates the Automatic "START-UP" Mode. This is also used to turn the control "OFF", or activate the "SHUT DOWN" MODE.



### PRIME TOUCH PAD

This touch pad performs the same function as it has with any Louisiana Grills board. Asked for from the competition cookers. When the touch pad is pressed and held, the FUEL FEED system will turn and feed more pellets to the burn grate. This can be used to add more fuel just before opening the grill lid, resulting in a quicker heat recovery time. It can also be used to add more fuel, while smoking, to increase the amount of clean smoke flavor intensity.



### COOK TEMPERATURE UP and DOWN TOUCH PAD

By pressing either the UP or DOWN arrows, the LED read-out can be moved by 5 degree increments. The temperature can be set as low as 170°F, for hot smoking to a high of 600°F, for searing your steaks and hamburgers. Also used with the meat probe.



### LED DISPLAY SCREEN

This screen is used to display temperature readouts, as well as displaying error messages, and power up readouts. Temperatures can be displayed in either Fahrenheit or Celsius.

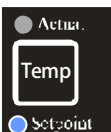

### TEMPERATURE DISPLAY

By pressing the TEMP display touch pad, the LED display screen will show and allow movement in either the "ACTUAL" temperature read out or the "SETPOINT" or desired temperature. The small LED beside both settings is used to indicate which temperature is presently being displayed.

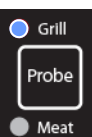

### PROBE SELECTION

By pressing the PROBE display touch pad, the LED display screen will show and allow movement in either the "GRILL" probe temperature read outs or the "MEAT" probe temperature readings. The small LED beside both settings is used to indicate which probe temperature is presently being displayed.



## Programmable Meat Probe

Designed using the latest in solid state electronics, the Digital Control Center now makes it even easier for anyone to slow smoke, bake or sear like a professional "Pitmaster". Not only will the control give you the ability to set and automatically maintain your desired cooking temperature (170 °F Hot Smoke to 600 °F Searing) just like your indoor oven, but now with the addition of a separate food probe, it will cook your food to your desired internal temperature, then adjust the control to a "keep warm" temperature. Along with the true convection cooking within the grill, keeping your culinary delight from drying out, all you have to do is to set it, then relax or even sleep soundly, while the Digital Control Center will do the rest.

This screen is used to display that there is no internal (meat) connected to the Digital Command Center, when the meat probe selection has been active.



# Knowledge is Power

## How the Board Works 101

### START-UP mode

Allows electricity to flow to all the electrical components for 20 minutes. This is a software set program that will automatically start the combustion/cooling fan, the igniter and the feed system at a preset rate, until the grill probe reaches a temperature of 150°F. Once met, the igniter will shut off and the feed rate is controlled by the control board. If for any reason the 150°F is not reached in 20 minutes, the control will turn OFF and an ER-2 will display on the screen.

### SHUT DOWN mode

When finished “Savoring the Flavor”, simply push the OFF touch pad. The control will turn off only the feed system, allowing the fan to continue to run not only to burn out the fuel, clean and efficiently, but also to cool down the grill. When the grill probe reaches 130°F the control will shut off completely.

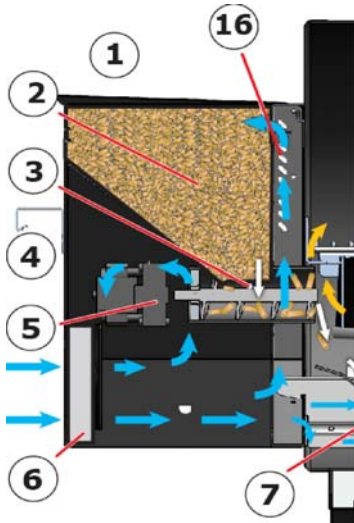

### Fan Cooled Hopper

The entire line of LG SERIES Smokers utilize the exact same hopper and component parts. To increase the life of your grill and its main working component parts the Combustion / Cooling fan is used to perform 3 main functions:

1. Pressurize the internal hopper compartment to cool the wiring, electrical component parts and the wood pellets.
2. Forces constant air movement between the hopper and the grill barrel wall. Because of higher temperatures needed for searing and because of the longer length of time a pellet grill can operate, such as slow smoking a whole hog, air movement is used to provide an air barrier between the two surfaces. **Ensure the air slots found on the front and back of the hopper do not get blocked off, at any time.**
3. To provide combustion air, allowing the pellet fuel to burn properly. The fan forced air is then used to provide “Convection Cooking” within the smoking grill. Convection cooking locks in the juices and distributes the heat evenly throughout the grill resulting in that savory flavor and near perfect cooking.



### Powder Coat Finish

Louisiana Grills uses a “High Heat Powder Coat” finish throughout the entire line of the Smokers. This High Heat finish is rated for 1000°F. This is done to allow for easy and trouble free maintenance, and adding to the life of your smoking grill. Powder coating is environmentally friendly and produces an excellence and superiority of finish that customers count on. Maintaining the initial appearance of a powder coating is a simple matter. **If the finish does scratch, flake, rust or just needs to be “freshened-up” it is important to use a touch-up paint ( High Heat BBQ) to repair it as soon as possible.** (see maintenance for further detail)

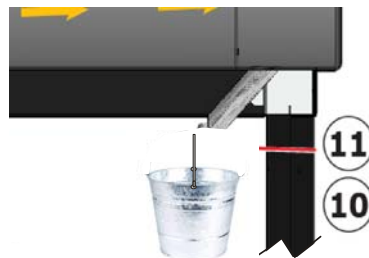

### Grease Catcher

All LG Smokers use the “Arched Flame Broiler” system that channels any excess grease, that does not evaporate, directly to a sealed grease catch area. From here any excess grease is directed to the drop spout where it is disposed in, an easy to clean or replace, metal bucket. The metal handle of the bucket simply hooks on the notched out groove of the grease spout. Allow the grease to cool before removing the pail.

**TIP:** if you want to replace your grease fill bucket with a new one, save any small metal buckets that you acquire from yard candles, etc. .

# Knowledge is Power

## 100% Natural Hardwood Wood Pellets



They are no thicker than the eraser on the end of a pencil. People who see them for the first time think they look like rabbit food, but there is nothing small about the heat energy or flavor in a wood pellet. These clean burning wood pellets generate about 8200 BTU's per pound with very little ash (.3lb/40lb bag) and low moisture content (5-7%) and are "carbon neutral".

Barbeque wood pellets are produced in the same matter as wood pellet fuel is produced for home heating, PFI Standard Premium Grade (see pelletheat.org). Pure raw material (sawdust) is pulverized with a hammer-mill and the material is pushed through a die with pressure. As the pellet is forced through the die it is sheared off at a specific maximum length, cooled, screened, vacuumed, and then bagged into 20 or 40 lb. bags.

BBQ wood pellets differ from smoking pellets, used in gas or propane grills, in that most are a combination of the main flavor and a neutral flavor.

### Flavor Guide Lines

	Beef	Buffalo	Lamb	Pork	Poultry	Fish	Vegies	Baking
Hickory	X	X		X	X	X		
Mesquite	X	X		X	X	X		
Alder	X	X	X	X	X	X	X	X
Apple				X	X	X		X
Cherry	X	X	X		X	X		X
Competition	X	X	X	X	X	X	X	X

Louisiana Grills is always looking for new existing blends of wood, from coast to coast.

- W**isconsin Hickory and Maple blend 40/60  
Rich, smoky bacon like flavor. Considered the "Kings of the Woods"
- G**eorgia Pecan and Maple blend 40/60 Southeast delicate flavor.  
Smoky, Bacon-like flavor. Similar to Hickory but not as strong.
- M**innesota Maple 100% Eastern and Midwest  
Mild, neutral, hint of sweetness.
- T**exas Mesquite and Maple blend 35/65  
Strong, tangy, spicy flavor. Think Tex-Mex cuisine.
- N**ew England Apple and Maple blend 40/60  
Smoky, mild sweetness flavor. Highly recommended for baking.
- W**ashington Alder 100% Pacific Northwest  
Mild, neutral, hint of sweetness, Used for over 100 years with salmon.
- P**ennsylvania Cherry and Maple blend 40/60  
Slightly sweet but also tart. Gives a rosey tint to light meats.
- C**ompetition Blend  
50% Maple. 25% Hickory. 25% Cherry  
Perfect blend of sweet, savory and tart. Used by many professional "Pitmasters".
- T**ennessee Whiskey Barrel - Premium Blend  
80% Oak. 20% Whiskey Barrel  
Strong, sweet smoke with aromatic tang. Perfect for red meats.



**TIP** Always store your pellets in a dry area. Avoid any contact or exposure to moisture. This will cause the pellets to absorb the moisture and will result in lower BTU output or cause the pellets to swell and break apart. Use a moisture proof re-sealable tub or bucket.



With today's lifestyle of striving to eat healthy and nutritious foods, one factor to consider is the importance of reducing fat intake. One of the best ways to cut down on fat in your diet is to use a low fat method of cooking, such as grilling. Because a pellet grill uses natural wood pellets, the savory wood flavor is cooked into the meats, thus reducing the need for high sugar content sauces.

Throughout this manual you will notice the emphasis on grilling food slowly at MEDIUM temperature settings. Because of the benefit of convection cooking and the use of the "Arched Flame Broiler", your country smoker will enable you to avoid flare-ups and maximize the nutritional value of the foods that you cook.

Following is a list of the important tips that will contribute to the cooking perfection that you expect when using your Country Smoker.



## Environment

As with all barbecues, the outside weather conditions will play a big part in the performance of your Country Smoker and the cooking time needed to perfect your culinary delights. Your Country Smoker, because of its single wall construction, should be considered as a 2 to 3 season grill, depending on what part of the country you live in. For greater detail on grilling and weather conditions, see the "HOT and COLD" weather tips found further in this owners manual.

## Grill Placement

All Country Smokers should always be a minimum of 12 inches away from any wall behind the grill. Your grill does come with wheels or casters to make movement easier. If you are able to shelter your smoker from the wind, this will aid in temperature output, heat retention, and heat recovery time when opening the lid. Turning the smoker a 1/4 turn, keeping the smoke vent holes out of the wind, will result in better temperature output.

## Operating the Grill

### Initial Burn Off

Before cooking on your smoker / grill for the first time, we recommend that you "Burn Off" the grill to rid it of any foreign matter. Light and operate the grill on HIGH, or above 500°F, with the lid down, for 30—40 minutes.

### Lighting your Grill

It is recommended practice to always go through the SET UP Procedures after every 1 to 3 uses. This will ensure proper ignition and many happy grilling experiences. Light as per instructions, found in this manual. If the grill fails to light, this is most likely due to a dirty or full burn grate blocking the auto igniter air passages. (refer to lighting instructions found elsewhere in this manual).

Should your auto igniter refuse to ignite the wood pellets, it is easy to light your grill manually with a match and lighting agent. (refer to manual lighting instructions found elsewhere in this manual).

### Pre-Heating

**It is extremely important to ALWAYS allow your grill to preheat, reach temperatures over 450°F for over 5 to 10 minutes, before cooking, each and every time.** This allows the grill and cooking grids to heat up quicker; it burns off any bacteria or foreign material left over; and grill is able to maintain its cooking temperature once your food is placed in the cooking area. When you do not take the time to PREHEAT, you will find that it takes a much longer period of time to bring both the grill and food to cooking temperature.

Always PREHEAT your country smoker with the lid closed. Set your temperature control to HIGH, start your grill, and allow your grill to PREHEAT (450°F OR OVER) for 5 to 10 minutes. This gives you plenty of time to prepare your food for the grill, as well it is the final step in cleaning your cooking grids.

**NOTE: After Pre-Heating is complete, set your desired cooking temperature, and leave your lid open until the actual temperature is close to your desire temperature.**

### Lid Position

Always cook with the lid closed. Not only does this keep the temperature even, the food will cook faster, and you will use less fuel by taking advantage of the fan forced convection cooking. A closed lid also helps to create that savory smokier flavor. You can slow down your cooking by propping up the lid using a grid lifter.

**CAUTION:** Grease fires are caused by not properly maintaining your grill, or failing to clean the bottom of the barrel on a consistent basis. In the unlikely event you experience a grease fire while cooking, quickly remove any food items, then close the lid. If it does not go out in a very short time, open the lid and lightly sprinkle baking soda on the fire. Be careful not to burn yourself. If this does not work, then turn OFF the control board, to stop the pellets from feeding, and shut the lid until the fire is completely out.

# Getting Started

## Set Up Procedure

Please note that during shipping or moving around on your deck, some movement within the grill may have taken place, so a complete visual inspection is required. Please follow these Initial Set-Up procedures to ensure the proper and safe operation of your grill.

**TIP** It is a highly recommended practice to always go through these basic SET UP PROCEDURES, after every 1 to 3 cooking's. This will ensure proper ignition, heat output and many continuous happy grilling experiences.



### Step 1

Open the SMOKER LID and remove the Cooking Grids (13).

### Step 2

Remove the "Arched Flame Broiler" (12). Clean off any excess food drippings or grease build-up.

### Step 3

Remove the Stainless Steel Burn Grate (8) and inspect the Burn Pot (9). Remove any foreign items. Ensure that the air holes in the grate (8) and the Igniter (7) are clear of debris.

**Note:** You can line the bottom of the barrel with heavy-duty aluminum foil. Line from left to right, starting from the burn pot area and going to the Arched Flame Broiler support. This will make clean-up and general maintenance easier.

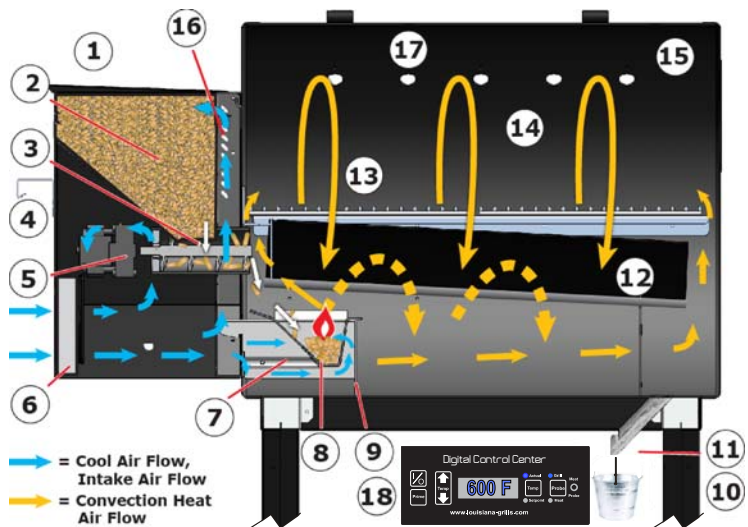

### Step 4

Re-install the Burn Grate (8). Ensure that the stainless steel grate is sitting down and snug in the burn pot (9) and that the igniter is lined up properly with the hole in the burn grate. You may have to gently lift up or down on the igniter to align with the hole.

### Step 5

Re-install the "Arched Flame Broiler" (12). The larger piece of the "Arch" should be facing upward and the flame slots close to the hopper end of the barrel. This then sits on the mounting bracket and grease divider plate. The slot hooks over the moveable hanging bracket found over the pellet fuel drop area. Ensure that this mounting bracket is snug against the barrel. The second piece of Flame Broiler then fits on the top of the first and then slide "Closed". If you are cooking anything with a large amount of drippings, you may want to line the "Closed" Arched Flame Broiler with heavy-duty aluminum foil, to make cleaning easier.

### Step 6

Re-install the Cooking Grids (13)

### Step 7

Ensure the Grease Bucket (11) is installed, cleaned and ready to go.

### Step 8

Open the Hopper Lid (1) and check for any foreign materials. Fill the hopper (2) with your choice of all natural wood pellet fuel.

### Step 9

Plug it in. Start it up. Savor the Flavor !

# Getting Started

Following is a list of the important tips that will contribute to the cooking perfection that you expect when using your Country Smoker.



**NOTE:** The temperature readout on the control board may NOT exactly match the dome thermometer.



## Operating the Grill ... con't

### Cooking Temperature Ranges

#### **HIGH 400°F to 600° F**

The HIGH range will give an oven temperature of over 450 to 600°F (316°C), depending on the weather. This setting is used to quickly preheat your grill as well as to finish the cleaning cycles for the cooking grids and the “Arched Flame Broiler”. Could also be used as a HIGH setting in extreme cold weather conditions or if cooking with the hood open. Also can be used with the Arched Flame Broiler open to create those “Dirty or Blue” steaks as well as flame kissed vegetables.

#### **MEDIUM TEMPERATURES 275° F TO 350° F**

This range is best for baking, roasting, and finishing off that Slow Smoked creation. This range will greatly reduce the chances of a flare up, with the Arched Flame Broiler in the CLOSED position. Great range for cooking anything in bacon, or were you want control.

#### **LOW 170°F to 250° F**

The LOW setting will give an approximate oven temperature of 170 to 220°F. This setting is used to slow roast; to increase the smoke flavor; to keep foods warm; and many other savory things. Highly recommended for the BIG BIRD at Thanksgiving, Easter ham, or that huge Christmas feast.

Smoking is a variation on true barbecuing and is truly the main advantage of grilling on a wood pellet grill. There are two types of smoking: HOT SMOKING and COLD SMOKING. HOT smoking, just another name for barbecuing is generally done at 170 to 250°F. HOT smoking works best when a longer cooking time is required, such as large cuts of meats, fish, or poultry. COLD smoking is where the food is located so far away from the fire that it smokes without cooking. Your Country Smoker is classified as a HOT smoker.

Experiment with the length of time you leave for smoking, before cooking thoroughly. Some chefs, or Pit Masters as the barbecue world call them, prefer to smoke at the end of cooking and to keep the food warm

**TIP** The temperatures listed above are all approximate and will be affected by the outside temperature, the amount and direction of wind present, the length and type of pellet fuel being used and the number of times the lid is opened.



## After Cooking - “Cleaning Up”

One of the greatest benefits of your Country Smoker is the minimal clean up required. When you are finished cooking and waiting just a little while to let the flavor set in that prime selection of meat, we recommend the following:

1. Using a long handle grill cleaning brush, brass or soft metal, to remove any food or build-up from the cooking grids, while it is still warm.
2. Turn the temperature control to HIGH for 5 minutes. Let the grill heat up, then push the STOP touch pad and your done.  
- The control will stop feeding pellets, but the fan will continue to burn them properly, till they burn out, and then the unit will shut down automatically in 20 minutes.
3. A quick wipe up of the powder coat surfaces, using a cloth, warm water and mild soap, will keep the unit looking like new.
4. Let the smoker cool and put your Country Smoker to bed with the optional GRILL COVER.

**TIP** To intensify that savory flavor, switch to hot smoke (low) temperature range immediately after putting your food on the grill. This allows the smoke to penetrate the meats before the pores in the meat close at 120°F.



# Getting Started

**TIP** It is a highly recommended practice to always go through these basic SET UP PROCEDURES, after every 1 to 3 cooking's. This will ensure proper ignition, heat output and many continuous happy grilling experiences.



## Start-Up Procedure - Automatic

**Always check the burn pot, burn grate, igniter holes, flame protector, cooking surfaces hopper and wood pellet fuel before starting or using your smokin grill.**



1. Plug the power cord into a 110Volt grounded electrical outlet. DO NOT break the ground end off the cord or use a non-grounded outlet or extension cord.

**NOTE: If the appliance does trip a GFI protected circuit, plug appliance into a surge bar first, then into the wall outlet.**

2. Open the hopper lid. Ensure that there are no foreign objects in the hopper or feed system. Fill the hopper with dry, all natural, flavored wood pellets.
3. Press the ON/OFF touch pad.  
The "START UP" mode will begin  
The FEED SYSTEM will begin to feed fuel at the preset software rate, the igniter will begin to "glow" and the fan will begin to operate.  
The START UP mode is timed to last 20 minutes or until the appliance reaches an operating temperature of 150°F.
4. Press the DISPLAY touch pad to display the SETPOINT.

5. Using the UP ARROW set the beginning temperature to over 500°F.

**NOTE: Always allow the grill to PREHEAT before adjusting the temperature to the desired output**

6. After allowing the grill to PREHEAT use the arrow touch pads to adjust the temperature to the desired temperature.

**TIP: When reducing your desired temperature to a lower setting, it is highly recommended to lift the lid until the ACTUAL temperature is relatively close to the new DESIRED temperature.**



## Start-Up Procedure - Manual

1. Plug the power cord into a 110volt grounded electrical outlet. DO NOT break the ground end off the cord or use a non-grounded outlet or extension cord.
2. Open the hopper lid. Ensure that there are no foreign objects in the hopper or feed system. Fill the hopper with dry, all natural, flavored wood pellets.
3. Remove the cooking grids, flavor guard system and the U shaped flame guard (if equipped with one) to expose the burn grate in the bottom of the unit.
4. Place two generous handfuls of pellets into the burn grate.
5. Squirt gelled fire starter, or other approved pellet starter, into the burn grate over the top of the pellets.
6. Light the starter using a long fireplace match or long lighter.  
**WARNING: NEVER ATTEMPT TO ADD MORE STARTER INTO A FIRE THAT IS ALREADY BURNING OR INTO A HOT BURNGRATE. YOU COULD EXPERIENCE A BURN BACK AND YOU COULD GET SERIOUSLY BURNT.**
7. Allow the STARTER to burn for 3 to 5 minutes.
8. Carefully replace the flame guard (if supplied), the flavor guard and cooking grids.
9. Follow STEPS 3 to 6 found in AUTOMATIC start-up procedures.

# Getting Started

## Programmable Internal Food Probe



The Digital Control Center Programmable Food Probe is the newest addition to the Louisiana Grills family and is a must tool for the beginner or professional “pitmaster”. By simply plugging the probe into the board, then into your culinary delight, set your desired internal food temperature, not only will it cook your primal feast to you setting, but it will automatically reduce your pit temperature to its lowest setting to keep food perfectly done, the way you like, every time. So sit back, relax, or enjoy a good nights sleep and get ready to “Savor The Flavor”.

### HOW TO:



Probe



#### PROBE PLUG-IN

Insert the 1/8” (3.5mm) audio-style plug from the food probe into this female adaptor. Ensure it is inserted all the way into the plug, you will feel and hear it snap in place.



#### CONTROL ON/OFF TOUCH PAD

Press this touch pad to activate the control .

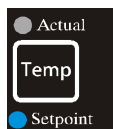
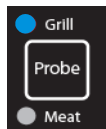

#### GRILL COOKING TEMPERATURE

Press the Probe pad to “GRILL”. Press the Temp pad to “SETPOINT”. Using the Cook Temp “Up” or “Down” arrow select your desired grill temperature from 170°F all the way to 600°F. Press Display a second time to show Actual Grill Temperature.

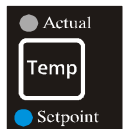

#### FOOD PROBE TEMPERATURE

Press the Probe pad to “MEAT”. Press the Temp pad to “SETPOINT”. Using the Cook Temp “Up” or “Down” arrow select your desired Internal Food Temperature.

The probe can be set from 50°F to 225°F.

Press Display again to show the Actual Food Probe Temperature.

**TIP! Set your desired temperature 10 to 15 degrees below your liking, as the food (meat) will continue to rise in temperature somewhat as the grill cools.**



#### SAVORY THE FLAVOR!

The control will automatically cook your food until the Actual Food Probe temperature is met. The control will then automatically drop its temperature to the lowest setting 180°F and alert you by an audio “BEEP”, six times. The Desire Temperature of the Grill will be automatically reduced to 180 F.

#### NOTE:

1. DO KEEP the Internal Food Probe as clean and dry as possible. Clean with a damp, soapy cloth. Like the Grill Probe, if the probe wires are exposed to liquids for an extended period of time, the probes may display an erroneous reading. In extreme cases the “Actual Temperature” will read “32”. To remedy this, allow the probe cord to dry completely before using again. A hair dryer will speed up the drying process.
2. DO NOT submerge the meat probe when cleaning or place in the dishwasher.
3. DO NOT kink the rugged yet small stainless steel armor braided wires.
4. DO NOT allow the moisture, smoke resistance, Teflon coated, Stainless Steel braided, high temperature wires to come in direct contact with flames.

#### CAUTION:

DO NOT USE ANY FLAMMABLE LIQUIDS SUCH AS GASOLINE, GASOLINE-TYPE LANTERN FUEL, KEROSENE, CHARCOAL LIGHTER FLUID, OR SIMILAR LIQUIDS TO START OR FRESHEN-UP THE FIRE! KEEP ALL SUCH LIQUIDS WELL AWAY FROM THE GRILL WHILE IT IS USE.

# Getting Started

## Shutting OFF Your Smoker

Your Louisiana Grills Country Smoker Pellet Grill will give you many years of flavorful service with minimum cleaning. An important step is allowing the grill and cooking grids to “Self Clean” by running the grill on HIGH or PREHEAT temperatures for 5 to 10 minutes after each use, over 450° F.

When finished cooking on your Louisiana Grill set your desired temperature to 450° F—500° F Let your grill run for 5 to 15 minutes, depending on what you just cooked, to go through its normal cleaning method. If you were preparing meats that were extra greasy, such as anything in BACON, it is a good practice to allow the grill to burn off for an extra 10 to 20 minutes. You could experience a grease fire, but DO NOT PANIC, DO NOT UNPLUG the appliance, just leave the lid closed and let the grill burn itself out naturally. Much like a self-cleaning oven. This will greatly reduce the chances of “Flare-Up” while you are preparing your next savory meal.

When cleaning is complete, simply push the STOP touch pad. Your Louisiana Grill Control will begin its automatic SHUT DOWN or Cool Down procedure.

- The FEED system will stop feeding fuel.
- The flame will burn itself out naturally.
- The combustion / cooling fan will continue to run until the unit cools to 130° F.
- When the procedure is complete the FAN and POWER LED will turn OFF.

If you did forget to grill desert, you can press the START touch pad. If the Actual Grill Temp. is above 150°F the grill will continue to operate as normal. If below 150°F it will go through the START UP mode again.

---

## Grill Maintenance

There are two extremes when it comes to keeping the grill clean. Those that must spit and shine the entire grill, in and out, after every use, and those whom are convinced that cleaning only takes away from that barbecue flavor. One simple rule: EVERYTHING IN MODERATION !

**TIP** Be diligent in your cleaning and maintenance program Taking care of your grill will add years of life to it and keeps it looking great!



### STARTING THE SEASON OUT RIGHT

A little time and effort at the beginning of the season will not only help extend the life of your grill but will also ensure the reliability of it. Making you look like the “King or Queen of the Grill”! Most of the cleaning techniques are below. Check with your local dealer, they may provide a yearly maintenance program and inspection service.

### STAINLESS STEEL WORKING SURFACES

ALWAYS clean dirt and dust off all stainless steel surfaces before you begin to cook. The dirt can cook into the metal and discolor it. These can be easily cleaned with hot soapy water and a soft cloth. A quick swipe of “Stainless Steel Cleaner” and a soft rag will also work, but you must be careful not apply it to the painted surfaces or interior parts. With the popularity of stainless steel appliances increasing, there are now many commercial products made to clean and protect stainless steel surfaces.

### POWDER COAT OR PAINTED SURFACES

**Powder coat or Paint and maintaining these coat surfaces are not covered under warranty.**

**This is part of general maintenance and upkeep.**

Be sure to cure your brand new Country Smoker for at least 30 to 40 minutes before using it for the first time. This allows the finish to cure properly and allows for that “NEW SMOKE SMELL” and manufacturing residue to be burned off.

**DO NOT use oven cleaner, abrasive cleaners or pads on the finished surfaces.**

Once installed, maintaining the initial appearance of any finish is a simple matter. The smoke and grime which builds up on surfaces from time to time contains moisture and salts which will adversely affect the powder coating and must be removed. Finish Coatings should be washed down regularly. The coating should be washed down with soapy water -- use a neutral detergent -- and rinsed off with clean water.

When powder coated items are maintained regularly, they should be relatively permanent.

**NOTE: If for any reason you do experience, scratches, wearing, or flaking of the finish, both Powder Coat or Paint finishes can be touched up or repainted using High Heat BBQ Paint.**



# Grill Maintenance ....con't

## COOKING GRIDS

When new, wash thoroughly with warm soapy water, place back in the smoker and PREHEAT the grill for 20 to 30 minutes. After the completion of grilling, open the lid and with a long handle grill cleaning brush give the grids a thorough cleaning. If you do not have a cleaning brush use long handle tongs and a balled up piece of aluminum foil wrap. Next turn the grill to "High" or "Preheat" Temperature until only an occasional wisp of smoke is seen (about 5 minutes) . This will remove most of the material that builds up on the cooking grids.

The next time you grill allow the smoker to PREHEAT for 10 to 15 minutes to complete the cleaning cycle. Give the grids a quick wipe down with your cleaning brush. Applying a thin coating of cooking oil on the grids before placing your meat on them will also decrease your cleaning time, as well as allowing to move your food easily without sticking and tearing.

## THE BIG COVER-UP

Your Country Smoker will help in protecting your grill from the detrimental effects of weather and outside pollutants. As with any outdoor product, however, a cover is only as good as the maintenance given to the grill. Following the recommended maintenance included in this manual will add greatly to the life of your grill.

### Helpful Hints

#### DO's

- Keep your Country Smoker cover clean. This is your best protection against mildew which will form on any dirt or foreign material allowed to accumulate on tops or bottoms of fabric. Use a cleaner or product that will not only clean but will also protect.
- Have any small tears or punctures repaired promptly.
- Keep away from pets.
- Keep all shrubs and vines away from your grill cover as many plants contain acids, which harm fabrics.



#### DO NOT

- Cover your grill while the grill is still hot
- Store anything on the top of your grill cover.
- Permit leaves, twigs or other organic debris to remain on the cover for long periods of time.
- Use high-pressure hoses or steam to clean.
- Use wire or stiff brushes , harsh detergents, abrasive cleaners or chlorine on your grill cover.

## ARCHED FLAME BROILER

This requires very little work, because of its construction and type of material used. From time to time you may need to brush off any burnt leftover, such as melted cheese or that extra thick bbq sauces. The best time to clean and inspect is when you perform the initial set-up procedures after every 1 to 3 uses.

To speed up cleaning we recommend that you line the "Closed" Arched Flame Broiler with heavy-duty aluminum foil. This foil should be replaced after each use and used only when the cooking temperature is below 400° F.

The grease channels do need to be cleaned from time to time to eliminate build-up, allow the grease to flow freely to the grease catch area and to allow for easy movement of the Flame Broiler Slide Top.

## THE COOKING BARREL

To start the season fresh, then maybe 2 to 3 times during the grilling season, it is recommended to remove the Arched Flame Broiler and Burn Grate. Then give the entire interior a good cleaning, de-greasing and vacuum, to remove everything that may have accumulated.

- Ensure that the grill is COMPLETELY COLD before using your shop vacuum or before scooping out and disposing of the ashes.
- You may want to use soapy hot water, a kitchen de-greaser, etc. to clean the entire inside of the barrel. This does reduce grease build-up and the possibilities of flare-ups.
- To aid in cleaning, it is recommended to line the bottom of the barrel with heavy duty aluminum foil. Start tight from burn side of the barrel and end at the grease stop area.

# Grill Maintenance ... con't

## SERIES 3 BURN POT

**The proper seating of the Burn Pot is crucial to proper grill performance.** The Series 3 Burn Pot has a solid, sealed bottom with a slot to permanently screw the pot to the barrel bottom. The main function of the Burn Pot is to channel the fan forced air into the Burn Grate, thus there is very little maintenance required. Occasionally you may either vacuum or brush out any ash build-up or burn debris that has fallen below the burn grate.

It is crucial that the Burn Pot is seated tight to the barrel side wall, tight to the barrel bottom, and is hooked and screwed in place to ensure proper placement.

## SERIES 3 STAINLESS STEEL BURN GRATE

Periodically check the air holes found on the sides of the Burn Grate for any blockage or build-ups.

Using a wire brush or flat-head screwdriver, scrape off any build-up or debris. If there is extreme build-up blocking the holes, you may wish to drill the holes clean.

When re-installing the Grate confirm the proper seating in the burn pot. The grate is seated straight, igniter hole and igniter line up and there is little play from side to side in the burn pot.

**SERIES 3 IGNITER** The 300 watt electric igniter needs very little maintenance. Confirm that the igniter is free of debris or blockage. Also check the four (4) set screws securing the hot rod into the stainless steel casing are snug. The hot rod should be flush with the angled front end.

## SERIES 4C FAN COOLED HOPPER ASSEMBLY

**ALWAYS DISCONNECT THE POWER TO YOUR GRILL BEFORE PERFORMING ANY SERVICE.**

There are a number of very quick checks that should be performed on the OUTSIDE of the hopper assembly:

1. Check and clean any debris from the fan air intake. Eg. Spider webs, tree fluff, etc.
2. Check and clean any debris for the air vent exhaust, found on the front and back sides.
3. Inspect and clean the fuel hopper area. The galvanized metal can be wiped down.  
To aid in protecting the metal and to allow pellet fuel to slide easily, you can apply a coating of car wax.
4. Inspect the metal auger area. Check for sawdust build-up and for debris.

You can remove the 6 (six) screws securing the end panel to the hopper assembly. There are two on the front, two on the back, and two on the under side. This will allow you to perform the following within the hopper assembly:

1. Check and clean any debris within the hopper housing.
2. Check and clean any debris from the fan blades or housing.
3. Check and clean any debris from the Auger Motor
4. Visual inspection on the wire harness and all wire connections.

Upon inspection replace all screws. Hand start each screw to ensure proper threading.

**GREASE CATCH AREA AND BUCKET** Always be sure the grease catch area is clean and free of debris. During the warmer months empty any grease build-up on a more frequent basis to avoid it from going rancid and to avoid having any extra creatures enjoying your grill.

## SLOWING DOWN . . . NOT PUTTING AWAY FOR THE SEASON

We recommend that at least once a month, while your grill is cold, that you should perform not only the above maintenance procedures, but also include the following.

1. Using a stiff vegetable brush knock-off any build-up scale on the inside walls of your grill.
2. Check the inside of the lid, the Arched Flame Broiler, and the inside walls of the cooking area. Using an old paintbrush, brush off any ash build-up found inside the firebox, grate and Arched Flame Broiler.
3. Give your entire grill a good cleaning with a shop vac, when cool to the touch, then quick wash and rinse.
4. Finally, visually inspect the powder coat or painted finish. touch up any scratches with the proper touch-up.



# Grilling Tips and Techniques



## COLD WEATHER COOKING

Just because the bright coloured leaves are gone and the golf clubs are put away for another season, doesn't mean you have to stop barbecuing. The clean crisp fresh air, the heavenly aroma of flavoured wood pellets and food cooking, may be just what the doctor ordered to cure those winter blahs. Holiday grilling also frees up your oven space for other important menu items. Following are a few suggestions on how to enjoy your grill throughout those cooler months:

**Remember:** Because of the cooler temperatures your SMOKE mode may fail. Use the COOK mode and the lower temperature control to achieve the same results. KEEP WATCH !!

**ORGANIZE** – Get everything you require ready in the kitchen before you head out to the great outdoors. Put what you need on a tray, bundle up tight, and “get it done!”

During the winter move your grill to an area that is out of the wind and cold. Check local bylaws regarding the proximity of your grill in relation to your home and/or other structures.

**Caution: Never grill in an unventilated area!**

To help you keep track of the outside temperature, you should place an outdoor thermometer close to your cooking area. This will help in determine how long it will take to cook your food.

You may want to keep a log or little written history on what you cooked, the temperature outside, and the results. This will help later down the road to help you determine what to cook and how long it will take.

When cooking in cold weather, it is better to increase your pre-heating time by at least 20 minutes.

Avoid lifting the grill lid any more than necessary. Cold gusts of wind can completely cool your grill temperature. Be flexible with your serving time; add about 10 – 15 minutes extra cooking time each time you open the lid.

As always, use a meat thermometer to determine the internal temperature of your foods.

Because the nights come sooner in the colder months, it is a good ideal to work in a lighted area or to have a light or flashlight close by.

Have a heated platter and maybe a cover ready to help keep your food warm while making the trip back inside.

Some of your better foods for winter cooking are those that require little attention, like roasts, whole chicken, ribs, and turkey. Make you meal preparation even easier by adding vegetables and potatoes.



## HOT WEATHER COOKING

Following are a few tips on hot weather cooking. As it gets hotter outside, not only will the cooking times of your food decrease but the cooking time on yourself decreases. Proper dress is a must. Shorts, T-shirt, shoes, hat, apron and a generous slab of suntan lotion go without saying. Don't forget the big tall cool drink; we don't want the chef to become dehydrated.

**ORGANIZE** – You don't have to serve a huge seven-course meal. You don't want to be cleaning your entire kitchen after every meal. Timing is everything to cooking outside and remember practise does make perfect. So practise lots and EXPERIMENT!!!

Adjust your cooking temperatures downward. This helps to avoid those unwanted flare-ups.

As always, use a meat thermometer to determine the internal temperature of your foods. This helps in preventing your meat from over cooking and drying out.

Even in hot weather, it is still better to cook with the lid of your grill down.

You can keep foods hot by wrapping them in foil and placing them in an insulated cooler. Stuff crumpled up newspaper around the foil and this will keep food hot for a good 3 to 4 hours.

Try to keep your menu on the lighter side. So you can enjoy the warm temperatures and quality family times.

# Grilling Tips and Techniques ..con't



Here are some helpful tips and techniques passed on to us from many Louisiana Grill owners, our staff, families and lots and lots of practise:

## TIP:

*Sauces are best applied near the end of cooking to prevent burning.*

- Before preheating the grill, make sure it is safe, clean and hygienic.
- **Always preheat your grill before cooking.** Set your Desired Temperature to above 450 ° F setting, be sure the lid is closed and allow the grill to heat for at least 10 – 15 minutes or until the thermometer registers over 450° F.
- Wipe off all stainless steel surfaces before preheating. Dirt and food stains will cook into the surface.
- **“Mise en Place”.** Three words that are essential for master grilling. The “Mise” refers to the basic setup of ingredients and equipment you need at grill side before you start cooking.
- Ensure the ash/drip pan is clean and free from any debris and fat build-up. You may want to line it with tinfoil to speed up your clean up time.
- Always check your pellet fuel hopper for debris and to ensure that you do not run out of pellets before finishing. Use a shop vac to clean out any sawdust build-up.
- To prevent foods from sticking, you can brush or rub cooking oil on the cooking grids. If using a vegetable spray use it only before lighting the burn pot. Never spray the grill while there is fire in the burn pot.
- Sear meats and cook with the lid down for perfectly grilled food every time.
- All Louisiana Grills are designed to allow even fan forced heat circulation, so foods cook evenly on all sides. Leave at least 1” of clearance between the food and the hood for proper heat flow.
- **Grilling times in recipes are based on 70°F (20°C) weather and little to no wind. Allow more time on cold, windy days, or even for higher altitudes. Allow less time for warmer weather.**
- To get better smoke penetration into your meats, go SLOW and LOW. Meat will close its fibres after it reaches a temperature of 120°F.
- Foods on a crowded cooking grate will require more cooking time than just a few foods.
- Foods grilled in containers, such as baked beans, will require more time if grilled in a deep casserole rather than a shallow baking pan.
- Use long-handled tongs for turning all meats and spatulas for turning burgers and fish. Do not use a fork for turning, as it will pierce the meat allowing the flavourful juices to escape.
- Misting or Mopping are great ways to keep meat from drying out when going SLOW and LOW. A mixture of 50/50 apple juice (not cider) and water keeps the meat moist and gives it great color.
- **A smart investment to purchase would be a BBQ Mat. Because of the fan force convection cooking a mat would protect that expensive deck or patio stone from the possibility of grease stains or accidental spills.**



# Grilling Tips and Techniques

## FOOD SAFETY TIPS AND TECHNIQUES

### 3

#### Three Basic Rules for Food Safety

1. Keep everything in the kitchen and cooking area clean.
2. Keep hot foods hot (above 140°F)
3. Keep cold foods cold (below 37°F)

We want you to enjoy healthy and safe grill cooking, so following are some hints for basic barbecue hygiene:

- Wash hands thoroughly with hot, soapy water before starting any meal preparation and after handling fresh meat, fish and poultry.
- Use a different platter and utensils for the cooked meat than the ones you used to prepare or transport the raw meat out to the grill. This will prevent cross contamination of bacteria.
- Use a different utensil for each marinade or basting sauce to prevent cross contamination.
- Do not leave hot foods out of refrigeration for more than two hours.
- Cooked foods and salads should not be left out in the heat for more than an hour. Fill a deep tray or casserole dish with ice to keep salads cool and safe.
- Do not defrost meat at room temperature or on a counter top. Thaw under refrigeration.
- Marinate meat in the refrigerator. Bacteria are living organisms that grow and multiply rapidly in warm, moist foods.
- A marinade should never be saved to use at a later day. If you are going to use it to serve with your meat, be sure to bring it to a boil before serving.
- Always use a meat thermometer to determine the internal temperature of the foods you are cooking. **Wood smoke turns meat and poultry pink. The pink band is a smoke ring and is highly prized by the true “Pit Masters”.**
- It's a good idea to put grilled food onto a heated platter, to help keep the food warm. Steaks benefit from resting for several minutes before serving. It allows those delicious juices that were driven to the surface by heat to ease back to the center.



# Trouble Shooting

**Proper cleaning, maintenance and the use of clean, dry, quality fuel will prevent common grill operational problems. However, when your Louisiana Grill is simply operating poorly or not at all, the following trouble shooting tips may be helpful.**

The following is not an exhaustive list. For more details or updated information, please check our website [www.dansons.com](http://www.dansons.com) and click on customer support, contact your local authorized dealer, or contact Dansons Customer Service at 1-877-303-3134. Model number \_\_\_\_\_ Serial number \_\_\_\_\_

Our service department is available to talk with you live Monday to Friday, 8am to 5 pm Mountain Time.

**DO NOT RETURN** the appliance without calling Dansons Customer Service for assistance.

**WARNING:** Always disconnect the electrical cord prior to opening the inspection plate of your grill for any inspection, cleaning, maintenance or service work.

**NEVER** perform any inspection, cleaning, maintenance or service on a **HOT GRILL**

Problem	Cause	Solution
<b>Control Will Not Turn ON</b>	<ul style="list-style-type: none"> <li>Grill is not properly plugged in</li> </ul>	<ul style="list-style-type: none"> <li>Ensure all wire connections are firmly connected</li> <li>Ensure grill is plugged into a working GFCI outlet</li> </ul>
	<ul style="list-style-type: none"> <li>The circuit board fuse has been tripped</li> </ul>	<ul style="list-style-type: none"> <li>Fuse must be manually replaced. (see board diagram at the end of this section)</li> </ul>
	<ul style="list-style-type: none"> <li>The GFI outlet has been tripped</li> </ul>	<ul style="list-style-type: none"> <li>Ensure all wire connections are firmly connected and dry</li> <li>Ensure GFCI is minimum 10 amp service.</li> </ul>
<b>“ER-1” Error Message</b>	<ul style="list-style-type: none"> <li>The grill has overheated, possibly due to grease fire or excess fuel.</li> </ul>	<ul style="list-style-type: none"> <li>Turn the grill off and allow to cool. Clean grill interior, remove excess pellets, and confirm positioning of all component parts.</li> </ul>
	<ul style="list-style-type: none"> <li>Temperature probe wire not making connection</li> </ul>	<ul style="list-style-type: none"> <li>Ensure probe wire is connected correctly to control</li> <li>Confirm wire connections and check for any damage</li> </ul>
<b>“ER-2” Error Message</b>	<ul style="list-style-type: none"> <li>Grill has failed to reach 150° F within the allotted 20 minutes.</li> </ul>	<ul style="list-style-type: none"> <li>Check hopper for sufficient fuel.</li> <li>Check burn grate positioning.</li> <li>Check burn grate and pot for ash build-up or obstructions</li> <li>Check igniter to see if it is heating up and positioned correctly</li> <li>Check fans to confirm operation and speed</li> <li>In extreme cold, grill may require a second start</li> <li>Hood should be closed</li> </ul>
	<ul style="list-style-type: none"> <li>Grill will not stay lit or above 150° F.</li> </ul>	<ul style="list-style-type: none"> <li>Same as above</li> </ul>
<b>noPr Error Message</b>	<ul style="list-style-type: none"> <li>Meat Probe not plugged in</li> </ul>	<ul style="list-style-type: none"> <li>Meat Probe not being used</li> <li>Ensure Meat Probe is inserted completely in board.</li> </ul>

# Trouble Shooting

Problem	Cause	Solution
<b>Actual Temperature reads 32° F</b>	<ul style="list-style-type: none"> <li>Internal Grill Probe needs cleaning</li> </ul>	<ul style="list-style-type: none"> <li>Use a soft cloth or mild abrasive sponge, along with hot water and soap to wipe clean the probe.</li> </ul>
	<ul style="list-style-type: none"> <li>Probe wire has become Wet</li> </ul>	<ul style="list-style-type: none"> <li>Remove the access panel from the bottom of the built-in.</li> <li>Use a hair dryer to dry the probe wires.</li> </ul>
<b>Cooling Fans will turn ON by themselves</b>	<ul style="list-style-type: none"> <li>Grill is exposed to high ambient temperature and direct sun.</li> </ul>	<ul style="list-style-type: none"> <li>The interior temperature has reach or gone over 130° F. It will not harm the unit.</li> <li>Place unit in shaded area.</li> <li>Prop the lid open to reduce inside temperature.</li> </ul>
<b>Grill will not achieve or maintain stable temperature</b>	<ul style="list-style-type: none"> <li>Insufficient air flow through burn grate</li> </ul>	<ul style="list-style-type: none"> <li>Check the burn grate for ash build-up, obstructions and that it is seated properly in the burn pot.</li> <li>Ensure that both the burn grate and burn pot are seated properly with no air leakage.</li> <li>Check the fan for proper operation, that it is working, that the air intake is not blocked and that there is no blockage in the hopper.</li> <li>Perform a quick test. Remove cooking grids and arched flavor guard. Ensure all the above has been done, start the grill, set temperature to pre-heat and wait for 10 minutes. Check that the flame produced is bright, vibrant and is being pushed away from the hopper end.</li> </ul>
	<ul style="list-style-type: none"> <li>Insufficient or poor fuel</li> </ul>	<ul style="list-style-type: none"> <li>Check the hopper for sufficient fuel.</li> <li>Check fuel for size, dampness and sawdust.</li> <li>Press and hold the Prime button. Ensure the auger is working and turning freely.</li> <li>Check and clean the temperature probe</li> </ul>
	<ul style="list-style-type: none"> <li>Control Settings</li> </ul>	<ul style="list-style-type: none"> <li>Ensure control is set on COOK mode</li> </ul>
<b>Grill produces excess or discolored smoke</b>	<ul style="list-style-type: none"> <li>Excess grease build-up or general cleaning</li> </ul>	<ul style="list-style-type: none"> <li>Check and clean the interior grilling area.</li> <li>It is a good practice to clean and do a controlled burn off of the hidden excess grease after each large cooking of tasty greasy foods.</li> </ul>
	<ul style="list-style-type: none"> <li>Wood pellet quality</li> </ul>	<ul style="list-style-type: none"> <li>Check and clear the hopper and burn grate of moist pellets, replacing them with fresh dry pellets.</li> </ul>
	<ul style="list-style-type: none"> <li>Burn grate</li> </ul>	<ul style="list-style-type: none"> <li>Check for build-up of fuel in the burn grate</li> </ul>
<b>Frequent Flare-ups</b>	<ul style="list-style-type: none"> <li>Cooking temperature</li> </ul>	<ul style="list-style-type: none"> <li>Slow and Low is the way to go.</li> <li>Grease does have a flash point, keep the temperature under 350° F when cooking highly greasy food.</li> </ul>
	<ul style="list-style-type: none"> <li>Grease or left-over's</li> </ul>	<ul style="list-style-type: none"> <li>Check and clean the interior grilling area.</li> <li>It is a good practice to clean and do a controlled burn off of the hidden excess grease after each large cooking of tasty greasy foods.</li> </ul>
<b>Igniter Will Not Light Fire</b>	<ul style="list-style-type: none"> <li>Burn Grate</li> </ul>	<ul style="list-style-type: none"> <li>Check for proper seating</li> <li>Check for ash build-up or obstructions</li> </ul>
	<ul style="list-style-type: none"> <li>Igniter</li> </ul>	<ul style="list-style-type: none"> <li>Check to confirm igniter DOES NOT get hot. DO NOT TOUCH the igniter or the housing, you will get burnt.</li> <li>Check on placement of the igniter hot rod to the burn grate.</li> <li>Remove front inspection plate, ensure wire connects are tight</li> </ul>

# Trouble Shooting

## "Digital Control Center" Board back view

**Grill Probe**  
spade connections

**Temperature Switch**  
Celsius / Fahrenheit  
C - F slide



### Board Wire Harness Connection

AC Hot Input		
Igniter		
Fan		
Auger Motor		
		AC Common

**5 amp 120 Volt Fuse**  
Fast-Blow Cartridge Fuse

The Digital Control Center system is an intricate and valuable piece of technology.

For protection from power surges and electrical shorts, the control utilizes a 1 1/4" x 1/4", 5 amp 120 volt Fast-Blow Fuse.

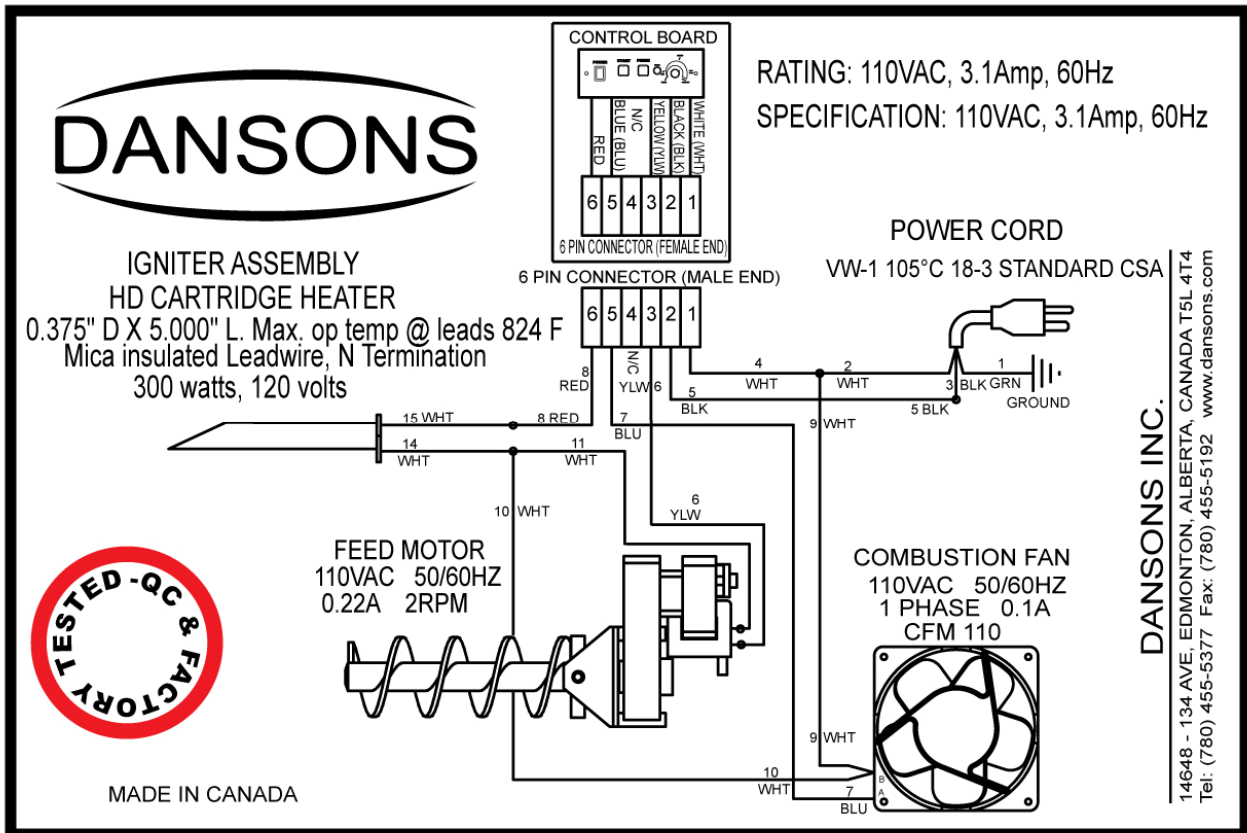

# Parts List

## REPLACEMENT ITEMS

Part No.	Description
various	Arched Flame Broiler - model related
50102	Auger Motor - 2 rpm
54070	Auger Shaft Assembly—CS
54261	Burn Grate—CS Super Grate— S3
54094	Caster— Standard
	Control — Standard (blue knob)
50120	Control — Deluxe Temperature Control
50125	Control— Digital Control Center — only
50127	Control—Digital Control Center Upgrade Kit - CS c/w Grill Probe & Meat Probe
various	Cooking Grids—Porcelain Coated
50133	Fan—CS Fan, LG Cooling Fan.
54400	Grease Bucket
various	Handle—Stainless Steel
54220	Handle—Hopper—Powder Coat
54091	Hitch Pins—CS axle and cotter pin
50163	Hopper Assembly Complete—CS S3
50190	Igniter Assembly—CS series 2 or 3
50112	Igniter— Hot Rod only
54088	Leveling Leg
59906	Paint—Touch Up Spray—
50121	Probe—Grill 36" SS
50152	Probe—Internal Meat
54402	Thermometer—Dome—LG
54086	Wheel 6" diameter
50117	Wire Harness—Main—CS
50131	Wire Harness—DTC Board only
50128	Wire Harness— DCC Board only



SEE YOUR "LOUISIANA GRILLS" DEALER FOR ADDITIONAL INFORMATION OR TO ORDER  
OR  
[www.shop.dansons.com](http://www.shop.dansons.com)

# Limited Warranty

The “LG SERIES Smoker” wood pellet barbecue line, manufactured by Dansons Inc., carries a five (5) year limited warranty from the date of sale to the original owner only, against defects and workmanship on all steel parts, (excluding the burn grate), and three (3) years on electrical components. There is NO specific warranty on grill probe, meat probe, the paint, powder coat, burn grate, grill cover and all gaskets or against damage caused from corrosion.



## Conditions of Limited Warranty

During the term of the limited warranty, Dansons Inc. obligation shall be limited to furnishing a replacement for covered, failed components, F.O.B. point of shipment. As long as it is within the warranty period, Dansons Inc. will not charge for repair or replacement for parts returned, freight prepaid, if the part(s) are found by Dansons Inc. to be defective upon examination. Dansons Inc. shall not be liable for transportation charges, labour costs, or export duties. Except as provided in this CONDITIONS OF WARRANTY paragraph, repair or replacement of parts in the manner and for the period of time stipulated hereunder shall constitute the fulfillment of all direct and derivate liabilities and obligations from Dansons Inc. to you.

**The warranty coverage begins on the original date of purchase and proof of date of purchase, or copy of original bill of sale, is required to validate the warranty.**

Repair or replacement of the “LG SERIES Smoker” part does not extend the limited warranty beyond the five (5) years or three (3) year from date of purchase.

The pouring of liquids on your grill flame will void this warranty.

Dansons Inc. takes every precaution to utilize materials that retard rust by using high-temperature paint or powder coat, where advisable. Even with these safeguards, the protective coatings can be compromised by various substances and conditions beyond Dansons Inc. control. High temperatures, grease fires, excessive humidity, chlorine, industrial fumes, fertilizers, lawn pesticides and salt are some of the substances that can affect paint and metal coatings. For these reasons, the limited warranties DO NOT COVER RUST OR OXIDIZATION, unless there is loss of structural integrity on the grill component. Should any of the above occur, kindly refer to you Instruction Manual’s maintenance section for paint finish protection. Dansons Inc. recommends that you purchase a full length protective cover, and cover your grill when not in use. Dansons Inc. also recommends the use of High Heat BBQ paint to repair or beautify your grill.

The warranties are based on normal domestic use and service of the grill and neither limited warranty coverage’s apply for a grill which is used in commercial applications.

# Limited Warranty

## Exceptions to the Limited Warranty

There is no written or implied performance warranty on “LG SERIES Smoker” appliances, as the manufacturer has no control over the installation, operations, cleaning, maintenance or the type of fuel burned.

This limited warranty will not apply nor will Dansons Inc. assume responsibility if your appliance has not been installed, operated, cleaned and maintained in strict accordance with the manufacturer's instructions. Burning other than quality wood pellets may void the warranty. The warranty does not cover damage or breakage due to misuse, improper handling or modifications.

**NEITHER THE MANUFACTURER, NOR THE SUPPLIERS TO THE PURCHASER, ACCEPTS RESPONSIBILITY, LEGAL OR OTHERWISE, FOR THE INCIDENTAL OR CONSEQUENTIAL DAMAGE TO THE PROPERTY OR PERSONS RESULTING FROM THE USE OF THIS PRODUCT. ANY WARRANTY IMPLIED BY LAW, INCLUDING BUT NOT LIMITED TO IMPLIED WARRANTIES OF MERCHANTABILITY OR FITNESS, SHALL BE LIMITED TO ONE (1) YEAR FROM THE DATE OF ORIGINAL PURCHASE. WHETHER A CLAIM IS MADE AGAINST THE MANUFACTURER BASED ON THE BREACH OF THIS WARRANTY OR ANY OTHER TYPE OF WARRANTY EXPRESSED OR IMPLIED BY LAW, MANUFACTURER SHALL IN NO EVENT BE LIABLE FOR ANY SPECIAL, INDIRECT, CONSEQUENTIAL OR OTHER DAMAGES OF ANY NATURE WHATSOEVER IN EXCESS OF THE ORIGINAL PURCHASE PRICE OF THIS PRODUCT. ALL WARRANTIES BY MANUFACTURER ARE SET FORTH HEREIN AND NO CLAIM SHALL BE MADE AGAINST MANUFACTURER ON ANY ORAL WARRANTY OR REPRESENTATION.**

Some states do not allow the exclusion or limitation of incidental or consequential damages, or limitations of implied warranties, so the limitations or exclusions set forth in this limited warranty may not apply to you. This limited warranty gives you specific legal rights and you may have other rights, which vary from state to state

The limited warranties for 5 (five) years or 3 (three) years are in lieu of all other warranties expressed or implied, at law or otherwise, and Dansons Inc. does not authorize any person or representative to assume for Dansons Inc. any obligation or liability in connection with the sale of the wood pellet grill. This means that no warranties, either expressed or implied, are extended to persons who purchase the product from any one other than Dansons Inc. or an authorized Louisiana Grills Dealer.

## Procedures for Warranty Service

Call your nearest “LG SERIES Smoker” dealer for repair or replacement of your “in-warranty” parts.

Be prepared to furnish the following information:

1. Copy of the bill of sale.
2. Purchaser's name, model and serial number of grill and date of purchase.
3. An accurate description of the problem.

**THIS LIMITED WARRANTY GIVES YOU SPECIFIC LEGAL RIGHTS AND YOU MAY HAVE OTHER RIGHTS, WHICH VARY FROM STATE TO STATE**

## SERIAL NUMBER AND MODEL NUMBER

YOUR SERIAL NUMBER AND THE MODEL NUMBER OF YOUR “COUNTRY SMOKER” CAN BE FOUND ON THE INSIDE OF YOUR HOPPER LID. BE SURE TO RECORD THESE IN THE SPACE PROVIDED BELOW TO AID YOU IF THEY GET DAMAGED OR LOST.

STAPLE YOUR ORIGINAL BILL OF SALE TO THIS PAGE AS WELL TO ENSURE YOU DO NOT LOSE IT!

MODEL

SERIAL NUMBER

DATE OF PURCHASE

AUTHORIZED DEALER



**Secure Your Bill of Sale - Here!**



**NEW 2013-14**

- Hickory Bacon
- Raspberry Chipotle
- Sweet Rib Rub
- Garlic Lemon Pepper
- Chop House Rub
- Key Lime Jerk

Available in 5 oz and 24 oz containers

Our Sauces, Spices and Rubs have NO MSG or MSG

**Cold Smoker / Warmer Attachment**



**Protective Cover**



**ACCESSORIES**

**Deluxe Stainless Front**



**Folding Side/Front Shelf**



**20 lb. Hopper Extension**



**Enclosure Kits**



**PARTS AND SERVICE**

Dansons Inc. stands behind our Authorized Dealers. We strongly suggest that if you do need to order any parts or options or require service, that you first deal with your local dealer. Many dealers do stock parts and options.

If for any reason you do not have a local dealer, Dansons Inc. is proud to offer the best technical and sales support in the industry. If you require parts, options, rubs and spices, or general accessories you can contact the factory directly :



**Louisiana Grills Customer Service**

TOLL FREE: 1-877-303-3134

TOLL FREE FAX: 1-877-303-3135

Email: [service@dansons.com](mailto:service@dansons.com)

Website: [www.louisiana-grills.com](http://www.louisiana-grills.com) or [www.shop.dansons.com](http://www.shop.dansons.com)

Proudly Made In China

**CHECK OUR WEBSITE FOR UP TO DATE ACCESSORIES, OPTIONS, AND INFORMATION!!**