

This Owner's Manual is provided and hosted by [Appliance Factory Parts](#).



COMFORT-AIRE VCG48TC2E Owner's Manual

[Shop genuine replacement parts for COMFORT-AIRE
VCG48TC2E](#)



[Find Your COMFORT-AIRE HVAC Parts - Select From 1486 Models](#)

----- Manual continues below -----

HEAT CONTROLLER

REPLACEMENT PARTS LIST

CCG / VCG / MCG Coils

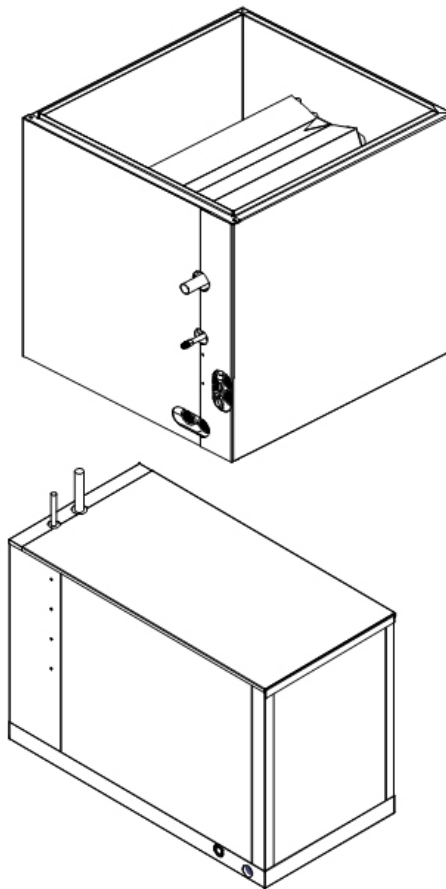

REPLACEMENT PARTS - Expansion Devices

Thermal Expansion Valve (TXV)

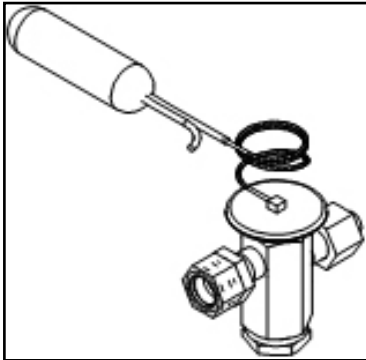

Part No.	Description
X5-3 (4200)	1.5-3.5 Ton, R-410A NON BLEED VALVE
X5-5 (4202)	4 & 5 Ton, R-410A NON BLEED VALVE

Note:

- 1) While ordering a replacement TXV, ensure that the valve ordered is compatible with the refrigerant in the system.
- 2) Refer to the product specific installation manual for field installation/replacement of a TXV.

Tail Piece

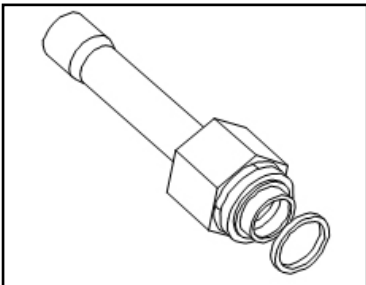

Part No.	Description
4444	ELIMINATOR TAIL PIECE
4151	TAIL PIECE WITH SREEN
4451	NUT FOR ELIMINATOR
4113	TEFLON SEAL O-RING
TP-001	ASSY, TAIL PIECE, NUT & O-RING

REPLACEMENT PARTS - Drain Pans

Drain Pans - Must Include "Description" with Part # when Ordering!

Note: 1) As detailed in the Installation manual, Plastic drain pans should not be used in conjunction with Oil Furnaces or in application where temperature exceeds 260°F. In such applications, metal drain pans should be used.

"P" or GLPP= Plastic Pan "MR"= Metal Right Side Drain "MTL"= Metal Pan "DD-R"= Double Drain Right Side

CCG Models

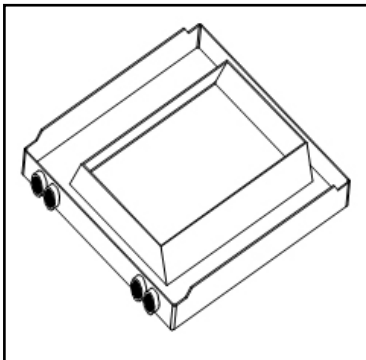

Model #	Part No.	Description
CCG24TA1E	Z30	13" GLPP
CCG24TB1E	Z31	16" GLPP
CCG24TA2E	Z7 DD-R	13"MTL
CCG36TA1E	Z30 P	13"GLPP
CCG36TB1E	Z31 P	16" GLPP
CCG36TC1E	Z32 P	19.5" GLPP Replacement
CCG36TB2E	Z14 DD-R	16" MTL
CCG36TC2E	Z32 P	19.5" GLPP Replacement
CCG48TB1E	Z31 P	16" GLPP
CCG48TC1E	Z32 P	19.5" GLPP Replacement
CCG48TD1E	Z33 P	23" GLPP
CCG48TB2E	Z14 DD-R	16" MTL

REPLACEMENT PARTS - Drain Pans

VCG Models

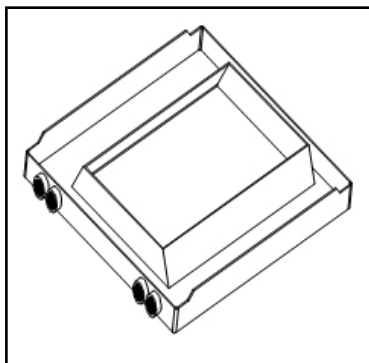

Model #	Part No.	Description
VCG24TA1E	Z30 P	13" GLPP
VCG24TB1E	Z31 P	16" GLPP
VCG24TB2E	Z31 MR	16-3/4" MTL
VCG36TA1E	Z30 P	13" GLPP
VCG36TB1E	Z31 MR	16-3/4" MTL
VCG36TC1E	Z32 P	16" GLPP
VCG36TB2E	Z31 MR	16-3/4" MTL
VCG36TC2E	Z32 P	19.5" GLPP
VCG48TB1E	Z31 P	16" GLPP
VCG48TC1E	Z32 P	19.5" GLPP
VCG48TD1E	Z33 P	23" GLPP
VCG48TC2E	Z32 P	19.5" GLPP
VCG60TC1E	Z32 P	19.5" GLPP
VCG60TD1E	Z33 P	23" GLPP

MCG Models

Model #	Part No.	Description	Horizontal Part #	Description
MCG24TA1E	Z30 P	13" GLPP	Z40 P	17X19.625 Horz P
MCG24TB1E	Z31 MR	16-3/4" MTL	Z40 P	17X19.625 Horz P
MCG24TA2E	Z7 DD-R	13" MTL	Z40 MTL	17X19.625 Horz MTL
MCG24TB2E	Z31 MR	16-3/4" MTL	Z40 MTL	17X19.625 Horz MTL
MCG36TA1E	Z30 P	13" GLPP	Z41P	21X19.625 Horz P
MCG36TB1E	Z31 P	16" GLPP	Z41P	21X19.625 Horz P
MCG36TC1E	Z32 P	19.5" GLPP	Z41P	21X19.625 Horz P
MCG36TB2E	Z31 MR	16-3/4" MTL	Z41 MTL	21X19.625 Horz MTL
MCG36TC2E	Z32 P	19.5" GLPP	Z41P	21X19.625 Horz P
MCG48TB1E	Z31 P	16" GLPP	Z42P	25X19.625 Horz P
MCG48TC1E	Z32 P	19.5" GLPP	Z42P	25X19.625 Horz P
MCG48TD1E	Z33 P	23" GLPP	Z42P	25X19.625 Horz P
MCG48TB2E	Z31 MR	16-3/4" MTL	Z42 MTL	25X19.625 Horz MTL
MCG48TC2E	Z32 P	19.5" GLPP	Z42P	25X19.625 Horz P
MCG48TD2E	Z33 P	23" GLPP	Z42P	25X19.625 Horz P
MCG60TC1E	Z32 P	19.5" GLPP	Z43P	28X19.625 Horz P
MCG60TD1E	Z33 P	23" GLPP	Z43P	28X19.625 Horz P
MCG60TC2E	Z38 DD	20-1/4X21.375	Z44 MTL	28X21.625 Horz MTL
MCG60TD2E	Z20 DD	23-1/2 X 21.375	Z44 MTL	28X21.625 Horz MTL

Misc.

Part No.	Description
126599	DOWNFLOW KIT - 3" X 16" PLATES

Due to ongoing product improvements, specifications and dimensions are subject to change and correction without notice or incurring obligations. Determining the application and suitability for use of any product is the responsibility of the installer. Additionally, the installer is responsible for verifying dimensional data on the actual product prior to beginning any installation preparations.

Incentive and rebate programs have precise requirements as to product performance and certification. All products meet applicable regulations in effect on date of manufacture; however, certifications are not necessarily granted for the life of a product. Therefore, it is the responsibility of the applicant to determine whether a specific model qualifies for these incentive/rebate programs.

HEAT CONTROLLER

1900 Wellworth Ave., Jackson MI 49203 • Ph. 517-787-2100 • www.heatcontroller.com

A  Company