

This Owner's Manual is provided and hosted by [Appliance Factory Parts](#).



# COMFORT-AIRE PCG 072 A-3L Owner's Manual

[Shop genuine replacement parts for COMFORT-AIRE  
PCG 072 A-3L](#)

The logo for Comfort-Aire is written in a blue, cursive script font. A registered trademark symbol (®) is located at the end of the word "Aire".

[Find Your COMFORT-AIRE HVAC Parts - Select From 1486 Models](#)

----- Manual continues below -----

HEAT CONTROLLER, INC.



*This parts list is current as of the above revision date.*

Form Number: 92-42810-PCG

# Table of Contents

Model Explanation .....	Page 3
<b>Parts Numbers</b>	
Panels - Miscellaneous 072-150 (1) .....	Page 4
Panels - Miscellaneous 072-150 (2) .....	Page 5
Panels - Miscellaneous 151 (3) .....	Page 6
Panels - Miscellaneous 151 (4) .....	Page 7
Panels - Miscellaneous 180-300 (1) .....	Page 8
Panels - Miscellaneous 180-300 (2) .....	Page 9
Electrical Group 072-150 .....	Page 10
Electrical Group 151 .....	Page 11
Electrical Group 180-300 .....	Page 12
Fan Group 072-151 .....	Page 13
Fan Group 180-300 .....	Page 14
Blower Group 072-151 .....	Page 15
Blower Group 180-300 .....	Page 16
Coil Parts 072-090 .....	Page 17
Coil Parts 102-150 .....	Page 18
Coil Parts 151 .....	Page 19
Coil Parts 180-300 .....	Page 20
Compressor Group 072-151 .....	Page 21
Compressor Group 180-300 .....	Page 22
Heater Kits .....	Page 23
Accessories 072-151 .....	Page 24
Accessories 180-300 .....	Page 25
<b>Drawings/Photographs</b>	
Exploded View 072-150 .....	Page 26
Exterior - Front 072-150 .....	Page 27
Exterior - Back 072-150 .....	Page 27
Filter-Coil Assembly 072-150 .....	Page 28
Condenser Coil Assembly 072-150 .....	Page 28
Front Panel Brackets 072-150 .....	Page 29
Filter Frame Assembly 072-150 .....	Page 30
Blower Assembly 072-150 .....	Page 30
Control Box 072-150 .....	Page 31
Exterior - Front 180-300 .....	Page 32
Exterior - Rear 180-300 .....	Page 32
Base Pan Assembly 180-300 .....	Page 33
Base Rail Assembly 180-300 .....	Page 33
Front Panel Brackets 180-300 .....	Page 34
Interior - Coil 180-300 .....	Page 34
Heat Compartment 180-300 .....	Page 35
Condenser Bulkhead 180-300 .....	Page 35
Filter Frame Assembly 180-300 .....	Page 36
Blower Assembly 180-300 .....	Page 36
Control Box 180-300 .....	Page 37
Electric Heat Block-Off 180-300 .....	Page 38
Notes .....	Page 39

**MODEL NUMBER EXPLANATION**

<b>P</b>	<b>C</b>	<b>G</b>	<b>0</b>	<b>7</b>	<b>2</b>	<b>A</b>	<b>-</b>	<b>3</b>	<b>L</b>
1			2			3			

- (1) **SERIES**
- (2) **COOLING CAPACITY (BTU/HR)**  
 072/073 = 72,000  
 085 = 85,000  
 090 = 90,000  
 102 = 102,000  
 120 = 120,000  
 150 = 150,000  
 151 = 150,000  
 180 = 180,000  
 210 = 210,000  
 240 = 240,000  
 300 = 300,000
- (3) **VARIATION**

**SERIAL NUMBER EXPLANATION**

<b>7</b>	<b>9</b>	<b>1</b>	<b>6</b>	<b>F</b>	<b>0</b>	<b>2</b>	<b>0</b>	<b>9</b>	<b>9</b>	<b>9</b>	<b>9</b>	<b>9</b>
1				2	3		4	5				

- (1) **COMPRESSOR IDENTIFICATION NUMBER**
- (2) **PRODUCTION LOCATION**
- (3) **WEEK OF PRODUCTION**
- (4) **YEAR OF PRODUCTION**
- (5) **PRODUCTION NUMBER**

No.	Notes	MODEL COOLING CAPACITY VARIATION	PCG 072/073 A-3L / A-4L	PCG 085 A-3L / A-4L	PCG 090 A-3L / A-4L	PCG 102 A-3L / A-4L	PCG 120 A-3L / A-4L	PCG 150 A-3L / A-4L
<b>PANELS - RAILS, BASE PANS, INSIDE CABINET</b>								
<b>BASE RAILS:</b>								
A		Base Rail - Front	AE-90575-15	AE-90575-15	AE-90575-15	AE-90575-15	AE-90575-15	AE-90575-15
B		Base Rail - Right	AE-90576-03	AE-90576-03	AE-90576-03	AE-90576-03	AE-90576-03	AE-90576-03
C		Base Rail - Rear	AE-90575-04	AE-90575-04	AE-90575-04	AE-90575-04	AE-90575-04	AE-90575-04
D		Base Rail - Left	AE-90576-04	AE-90576-04	AE-90576-04	AE-90576-04	AE-90576-04	AE-90576-04
<b>BASE PANS:</b>								
E		Outdoor Coil Base Pan	AS-90583-03C	AS-90583-05C	AS-90583-05C	AS-90583-05C	AS-90583-05C	AS-90577-14C
F		Indoor Coil Base Pan	AS-90577-12	AS-90577-12	AS-90577-12	AS-90577-12	AS-90577-12	AS-90577-12
<b>INSIDE CABINET:</b>								
G		Entry Plate	AE-90614-02	AE-90614-02	AE-90614-02	AE-90614-02	AE-90614-02	AE-90614-02
H		Entry Plate	AE-90614-01	AE-90614-01	AE-90614-01	AE-90614-01	AE-90614-01	AE-90614-01
J		Heat Compartment Side	AE-90598-09	AE-90598-09	AE-90598-09	AE-90598-09	AE-90598-09	AE-90598-09
K		Blower Deck	AS-90592-12	AS-90592-13	AS-90592-13	AS-90592-13	AS-90592-13	AS-90592-13
L		Wireway	AE-90718-05	AE-90718-05	AE-90718-05	AE-90718-05	AE-90718-05	AE-90718-05
M		Condenser Bulkhead	AS-90609-22	AS-90609-21	AS-90609-18	AS-90609-18	AS-90609-18	AS-90609-23

No.	Notes	MODEL COOLING CAPACITY VARIATION	PCG 072/073 A-3L / A-4L	PCG 085 A-3L / A-4L	PCG 090 A-3L / A-4L	PCG 102 A-3L / A-4L	PCG 120 A-3L / A-4L	PCG 150 A-3L / A-4L	
<b>PANELS - FRONT</b>									
1		Control Box Door Assembly - w/Hinges, Latch, Gasket, Insulation	AS-102872-14C	AS-102872-14C	AS-102872-14C	AS-102872-14C	AS-102872-14C	AS-102872-14C	
2a		Bracket - Top Panel (Left)	AS-102859-16C	AS-102859-16C	AS-102859-16C	AS-102859-16C	AS-102859-16C	AS-102859-16C	
2b		Bracket - Top Panel (Center)	AS-102859-15C	AS-102859-15C	AS-102859-15C	AS-102859-15C	AS-102859-15C	AS-102859-15C	
2c		Post - Blower Section	AS-102682-12C	AS-102682-12C	AS-102682-12C	AS-102682-12C	AS-102682-12C	AS-102682-12C	
3a		Bracket - Bottom Panel (Left)	AS-102859-17C	AS-102859-17C	AS-102859-17C	AS-102859-17C	AS-102859-17C	AS-102859-17C	
3b		Bracket - Blower/Heater Compartment	AS-102859-14C	AS-102859-14C	AS-102859-14C	AS-102859-14C	AS-102859-14C	AS-102859-14C	
3c		Bracket - Bottom Panel (Right)	AS-102859-13C	AS-102859-13C	AS-102859-13C	AS-102859-13C	AS-102859-13C	AS-102859-13C	
		Latch Assembly - Control Box Door (2)	64-102855-01	64-102855-01	64-102855-01	64-102855-01	64-102855-01	64-102855-01	
4		Post Assembly - Indoor Coil Section	AS-90620-18C	AS-90620-18C	AS-90620-17C	AS-90620-17C	AS-90620-17C	AS-90620-17C	
5		Control Box Cover	AE-90713-02	AE-90713-02	AE-90713-02	AE-90713-02	AE-90713-02	AE-90713-02	
6		Control Mounting Plate	AE-90712-06	AE-90712-06	AE-90712-06	AE-90712-06	AE-90712-06	AE-90712-06	
7		Low Voltage Shield	AE-90742-03	AE-90742-03	AE-90742-03	AE-90742-03	AE-90742-03	AE-90742-03	
8		Control Box Back Insulation Assembly	AS-90601-06	AS-90601-06	AS-90601-06	AS-90601-06	AS-90601-06	AS-90601-06	
9		Mounting Bracket	AE-90779-02	AE-90779-02	AE-90779-02	AE-90779-02	AE-90779-02	AE-90779-02	
10		Electric Heat Blockoff Plate Assembly (models with no heat)	AS-90720-02	AS-90720-02	AS-90720-02	AS-90720-02	AS-90720-02	AS-90720-02	
11		Terminal Block	See Electrical Group						
12		Electric Heat Access Panel Assembly - w/Hinges, Latch, Gasket, Insulation	AS-102872-18C	AS-102872-18C	AS-102872-18C	AS-102872-18C	AS-102872-18C	AS-102872-18C	
		Latch Assembly - Electric Heat Door (2)	64-102855-01	64-102855-01	64-102855-01	64-102855-01	64-102855-01	64-102855-01	
13		Power Entry Plate Assembly	AS-90774-11C	AS-90774-11C	AS-90774-11C	AS-90774-11C	AS-90774-11C	AS-90774-11C	
14		Blower Access Panel Assembly - w/Hinges, Latch, Gasket, Insulation	AS-102872-16C	AS-102872-16C	AS-102872-16C	AS-102872-16C	AS-102872-16C	AS-102872-16C	
		Latch Assembly - Blower Access Panel (3)	64-102855-01	64-102855-01	64-102855-01	64-102855-01	64-102855-01	64-102855-01	
15		High Pressure Guard (2)	AS-76160-01C	AS-76160-01C	AS-76160-01C	AS-76160-01C	AS-76160-01C	AS-76160-01C	
16		Heat Mounting Frame Assembly	AS-90754-02	AS-90754-02	AS-90754-02	AS-90754-02	AS-90754-02	AS-90754-02	
17		Condenser Coil Access Panel-Front	AS-90631-10C	AS-90631-09C	AS-90631-09C	AS-90631-09C	AS-90631-09C	AS-90631-11C	
18		Front Corner Post	AS-90701-06C	AS-90701-06C	AS-90701-06C	AS-90701-06C	AS-90701-06C	AS-90701-05C	

No.	Notes	MODEL COOLING CAPACITY VARIATION	PCG 072/073 A-3L / A-4L	PCG 085 A-3L / A-4L	PCG 090 A-3L / A-4L	PCG 102 A-3L / A-4L	PCG 120 A-3L / A-4L	PCG 150 A-3L / A-4L
<b>PANELS - RIGHT, REAR AND LEFT SIDES</b>								
<b>RIGHT:</b>								
19		Air Stop	N/A	N/A	N/A	N/A	N/A	N/A
20		Louver Panel Assembly	AS-90789-01C	AS-90789-01C	AS-90789-01C	AS-90789-01C	AS-90789-01C	AS-90789-03C
<b>REAR:</b>								
21		Rear Corner Post	AS-90702-03C	AS-90702-03C	AS-90702-03C	AS-90702-03C	AS-90702-03C	AS-90702-04C
22		Condenser Coil Access Panel-Rear	AS-90631-03C	AS-90631-05C	AS-90631-05C	AS-90631-05C	AS-90631-05C	AS-90631-12C
23		Rear Panel	AS-90618-02C	AS-90618-02C	AS-90618-02C	AS-90618-02C	AS-90618-02C	AS-90618-02C
24		Supply Cover	AS-90626-02C	AS-90626-02C	AS-90626-02C	AS-90626-02C	AS-90626-02C	AS-90626-02C
25		Return Cover	AS-90628-02C	AS-90628-02C	AS-90628-02C	AS-90628-02C	AS-90628-02C	AS-90628-02C
<b>LEFT:</b>								
26		Upper Left Panel	AS-90624-03C	AS-90624-03C	AS-90624-03C	AS-90624-03C	AS-90624-03C	AS-90624-03C
27		Lower Left Panel	AS-90624-04C	AS-90624-04C	AS-90624-04C	AS-90624-04C	AS-90624-04C	AS-90624-04C
28		Left Corner Panel	AS-90755-07C	AS-90755-07C	AS-90755-07C	AS-90755-07C	AS-90755-07C	AS-90755-07C
29		Plate - Receptacle	AS-90756-02C	AS-90756-02C	AS-90756-02C	AS-90756-02C	AS-90756-02C	AS-90756-02C
30		Plate - Disconnect	AS-90756-03C	AS-90756-03C	AS-90756-03C	AS-90756-03C	AS-90756-03C	AS-90756-03C
31		Button Plug (2)	45-22980-06	45-22980-06	45-22980-06	45-22980-06	45-22980-06	45-22980-06
32		Button Plug	45-22980-05	45-22980-05	45-22980-05	45-22980-05	45-22980-05	45-22980-05
<b>TOP:</b>								
33		Top Panel Assembly	AS-90616-06C	AS-90616-06C	AS-90616-06C	AS-90616-06C	AS-90616-06C	AS-90616-06C
34		Condenser Top Panel	AS-90703-09C	AS-90703-09C	AS-90703-09C	AS-90703-09C	AS-90703-09C	AS-90703-08C
35		Venturi	AS-90632-03C (2)	AS-90632-03C (2)	AS-90632-03C (2)	AS-90632-03C (2)	AS-90632-03C (2)	AS-90632-03C (2)
36		Wire Grille	95-100906-09 (2)	95-100906-09 (2)	95-100906-09 (2)	95-100906-09 (2)	95-100906-09 (2)	95-100906-09 (2)
43		Drain Pan - Removable	See Coil Group					

No.	Notes	MODEL COOLING CAPACITY VARIATION	PCG 151 A-3L / A-4L
<b>PANELS - RAILS, BASE PANS, INSIDE CABINET</b>			
<b>BASE RAILS:</b>			
A		Base Rail - Front	AE-90575-15
B		Base Rail - Right	AE-90576-03
C		Base Rail - Rear	AE-90575-04
D		Base Rail - Left	AE-90576-04
<b>BASE PANS:</b>			
E		Outdoor Coil Base Pan	AS-90577-14C
F		Indoor Coil Base Pan	AS-90577-12
<b>INSIDE CABINET:</b>			
G		Entry Plate	AE-90614-02
H		Entry Plate	AE-90614-01
J		Heat Compartment Side	AE-90598-09
K		Blower Deck	AS-90592-13
L		Wireway	AE-90718-05
M		Condenser Bulkhead	AS-90609-23

No.	Notes	MODEL COOLING CAPACITY VARIATION	PCG 151 A-3L / A-4L
<b>PANELS - FRONT</b>			
1		Control Box Door Assembly - w/Hinges, Latch, Gasket, Insulation	AS-102872-14C
2a		Bracket - Top Panel (Left)	AS-102859-16C
2b		Bracket - Top Panel (Center)	AS-102859-15C
2c		Post - Blower Section	AS-102682-12C
3a		Bracket - Bottom Panel (Left)	AS-102859-17C
3b		Bracket - Blower/Heater Compartment	AS-102859-14C
3c		Bracket - Bottom Panel (Right)	AS-102859-13C
		Latch Assembly - Control Box Door (2)	64-102855-01
4		Post Assembly - Indoor Coil Section	AS-90620-17C
5		Control Box Cover	AE-90713-02
6		Control Mounting Plate	AE-90712-06
7		Low Voltage Shield	AE-90742-03
8		Control Box Back Insulation Assembly	AS-90601-06
9		Mounting Bracket	AE-90779-02
10		Electric Heat Blockoff Plate Assembly (models with no heat)	AS-90720-02
11		Terminal Block	
12		Electric Heat Access Panel Assembly - w/Hinges, Latch, Gasket, Insulation	AS-102872-18C
		Latch Assembly - Electric Heat Door (2)	64-102855-01
13		Power Entry Plate Assembly	AS-90774-11C
14		Blower Access Panel Assembly - w/Hinges, Latch, Gasket, Insulation	AS-102872-16C
		Latch Assembly - Blower Access Panel (3)	64-102855-01
15		High Pressure Guard (2)	AS-76160-01C
16		Heat Mounting Frame Assembly	AS-90754-02
17		Condenser Coil Access Panel-Front	AS-90631-11C
18		Front Corner Post	AS-90701-05C

No.	Notes	MODEL COOLING CAPACITY VARIATION	PCG 151 A-3L / A-4L
<b>PANELS - RIGHT, REAR AND LEFT SIDES</b>			
<b>RIGHT:</b>			
19		Air Stop	N/A
20		Louver Panel Assembly	AS-90789-03C
<b>REAR:</b>			
21		Rear Corner Post	AS-90702-04C
22		Condenser Coil Access Panel-Rear	AS-90631-12C
23		Rear Panel	AS-90618-02C
24		Supply Cover	AS-90626-02C
25		Return Cover	AS-90628-02C
<b>LEFT:</b>			
26		Upper Left Panel	AS-90624-03C
27		Lower Left Panel	AS-90624-04C
28		Left Corner Panel	AS-90755-07C
29		Plate - Receptacle	AS-90756-02C
30		Plate - Disconnect	AS-90756-03C
31		Button Plug (2)	45-22980-06
32		Button Plug	45-22980-05
<b>TOP:</b>			
33		Top Panel Assembly	AS-90616-06C
34		Condenser Top Panel	AS-90703-08C
35		Venturi	AS-90632-03C (2)
36		Wire Grille	95-100906-09 (2)
43		Drain Pan - Removable	

No.	Notes	MODEL COOLING CAPACITY VARIATION	PCG 180/210 A-3L / A-4L	PCG 240 A-3L / A-4L	PCG 300 A-3L / A-4L
<b>PANELS - RAILS, BASE PANS, INSIDE CABINET</b>					
<b>BASE RAILS:</b>					
A		Front	AS-90827-03	AS-90827-03	AS-90827-03
B		Right	AE-90576-06	AE-90576-06	AE-90576-06
C		Rear	AS-90827-04	AS-90827-04	AS-90827-04
D		Left	AE-90576-05	AE-90576-05	AE-90576-05
<b>BASE PANS:</b>					
E		Outdoor Base Pan	AS-90583-09C	AS-90583-09C	AS-90583-09C
F		Indoor Coil Base Pan - Return Air	AS-90577-09	AS-90577-09	AS-90577-09
G		Indoor Coil Base Pan - Supply Air	AS-90577-10	AS-90577-10	AS-90577-10
<b>INSIDE CABINET PANEL/PIECES:</b>					
H 1		Entry Plate	AE-90614-01	AE-90614-01	AE-90614-01
H 2		Entry Plate - Rooftop	AE-90614-02	AE-90614-02	AE-90614-02
I		Post - Blower Section	AS-102682-07C	AS-102682-07C	AS-102682-07C
J		Heat Compartment Side	AE-90598-08	AE-90598-08	AE-90598-08
K		Blower Deck Assembly	AS-90592-11	AS-90592-11	AS-90592-11
L		Wireway	AE-90718-04	AE-90718-04	AE-90718-04
M		Condenser Bulkhead	AS-90609-17	AS-90609-17	AS-90609-17
N		Divider Panel - Between Coils	AE-90735-05	AE-90735-05	AE-90735-05
O		Bulkhead Support	AE-102725-01	AE-102725-01	AE-102725-01
P		Primary Drain Pan	AS-103030-02	AS-103030-02	AS-103030-02
		Air Stop - Outdoor Coil- Front	AE-90706-13	AE-90706-13	AE-90706-13
		Air Stop - Outdoor Coil- Rear	AE-90706-12	AE-90706-12	AE-90706-12
U		Coil Support Top	AE-102700-03	AE-102700-03	AE-102700-03

No.	Notes	MODEL COOLING CAPACITY VARIATION	PCG 180/210 A-3L / A-4L	PCG 240 A-3L / A-4L	PCG 300 A-3L / A-4L
<b>PANELS - FRONT AND RIGHT SIDES</b>					
1		Control Box Door Assembly - w/Hinges, Latch, Gasket, Insulation	AS-102872-04C	AS-102872-04C	AS-102872-04C
2a		Bracket - Top Panel (Left)	AS-102859-01C	AS-102859-01C	AS-102859-01C
2b		Bracket - Top Panel (Center)	AS-102969-01C	AS-102969-01C	AS-102969-01C
2c		Post - Blower Section	AS-102682-07C	AS-102682-07C	AS-102682-07C
3a		Bracket - Bottom Panel (Left)	AS-102859-02C	AS-102859-02C	AS-102859-02C
3b		Bracket - Blower/Heater Compartment	AS-102859-11C	AS-102859-11C	AS-102859-11C
3c		Bracket - Bottom Panel (Right)	AS-102859-12C	AS-102859-12C	AS-102859-12C
4		Post Assembly - Indoor Coil Section	AS-90620-15C	AS-90620-15C	AS-90620-15C
5		Control Box Cover	AE-90713-05	AE-90713-05	AE-90713-05
6		Control Mounting Panel	AE-90712-05	AE-90712-05	AE-90712-05
7a		Low Voltage Shield - Control Box (Upper Right)	AE-90742-07	AE-90742-07	AE-90742-07
7b		Low Voltage Shield - Control Box (Lower Left)	AE-90742-06	AE-90742-06	AE-90742-06
7c		Thermostat Chase Cover	AE-102722-01	AE-102722-01	AE-102722-01
8		Control Box Back	AS-90601-05	AS-90601-05	AS-90601-05
9		Bracket	AE-90779-02	AE-90779-02	AE-90779-02
10		Electric Heat Blockoff Plate Assembly (models with no heat)	AS-90720-03	AS-90720-03	AS-90720-03
11		Terminal Block - Heat Compartment	See Electrical Group		
12		Electric Heat Access Panel Assembly - w/Hinges, Latch, Gasket, Insulation	AS-102872-06C	AS-102872-06C	AS-102872-06C
13		Power Entry Plate Assembly	AS-90774-13C	AS-90774-13C	AS-90774-13C
14		Blower Access Panel Assembly - w/Hinges, Latch, Gasket, Insulation	AS-102872-02C	AS-102872-02C	AS-102872-02C
15		Ground Lug - Heat Compartment	See Electrical Group		
16		Mounting Frame - Heat Exchanger Frame	AS-90754-04	AS-90754-04	AS-90754-04
17		Condenser Coil Access Panel-Front	AS-90734-08C	AS-90734-08C	AS-90734-08C
38c		Post - Outdoor Coil (Front)	See Coil Group		
39c		Post - Outdoor Coil (Rear)	See Coil Group		

No.	Notes	MODEL COOLING CAPACITY VARIATION	PCG 180/210 A-3L / A-4L	PCG 240 A-3L / A-4L	PCG 300 A-3L / A-4L
<b>PANELS - REAR, LEFT, AND TOP</b>					
<b>REAR:</b>					
22		Condenser Coil Access Panel-Rear	AS-90734-09C	AS-90734-09C	AS-90734-09C
23		Rear Panel - Right	AS-90618-08C	AS-90618-08C	AS-90618-08C
24		Supply Cover	AS-90628-03C	AS-90628-03C	AS-90628-03C
25		Return Cover	AS-90628-04C	AS-90628-04C	AS-90628-04C
<b>LEFT:</b>					
26		Upper Left Panel	AS-90624-09C	AS-90624-09C	AS-90624-09C
27		Lower Left Panel	AS-90624-08C	AS-90624-08C	AS-90624-08C
28		Left Corner Panel Assembly	AS-90755-05C	AS-90755-05C	AS-90755-05C
		Bracket - Left Corner Panel Assembly (2)	AE-90779-01	AE-90779-01	AE-90779-01
		Gasket for receptacle plate	68-42514-08	68-42514-08	68-42514-08
		Gasket for disconnect plate	68-42514-09	68-42514-09	68-42514-09
29		Plate - Install inside Panel-Receptacle	AS-90756-02C	AS-90756-02C	AS-90756-02C
30		Plate - Install inside Panel-Disconnect	AS-90756-03C	AS-90756-03C	AS-90756-03C
31		Button Plug (3)	45-42558-01	45-42558-01	45-42558-01
32		Star Bushing (3)	45-18515-01	45-18515-01	45-18515-01
<b>TOP:</b>					
33a		Top Panel Assembly - Right	AS-90616-04C	AS-90616-04C	AS-90616-04C
33b		Top Panel Assembly - Left	AS-90616-05C	AS-90616-05C	AS-90616-05C
34a		Top Panel - Front	AS-90633-10C	AS-90633-10C	AS-90633-10C
34b		Top Panel - Middle	AS-90633-12C	AS-90633-11C	AS-90633-11C
34c		Top Panel - Rear	AS-90633-09C	AS-90633-09C	AS-90633-09C
35		Venturi	AS-90632-03C (4)	AS-90632-03C (6)	AS-90632-03C (6)
36		Wire Grille	95-100906-09 (4)	95-100906-09 (6)	95-100906-09 (6)
43		Drain Pan - Removable	See Coil Group		

No.	Notes	MODEL COOLING CAPACITY VARIATION	PCG 072/073 A-3L	PCG 085 A-3L	PCG 090 A-3L	PCG 102 A-3L	PCG 120 A-3L	PCG 150 A-3L
<b>ELECTRIC GROUP</b>								
11		Terminal Block	45-41669-01	45-41669-01	45-41669-01	45-41669-01	45-41669-01	45-41669-01
<b>CONTROL BOX COMPONENTS:</b>								
57	Stk	Transformer - Control	46-42515-04	46-42515-04	46-42515-04	46-42515-04	46-42515-04	46-42515-04
58a		Double Row Terminal Block	45-42548-02	45-42548-02	45-42548-02	45-42548-02	45-42548-02	45-42548-02
58b		Ground Lug	45-19000-02	45-19000-02	45-19000-02	45-19000-02	45-19000-02	45-19000-02
59	Stk	Contactora - Blower	42-22464-01	42-22464-01	42-22464-01	42-22464-01	42-22464-01	42-22464-01
60		Capacitor - Fan Motor	See Fan Group					
		High Pressure Control	See Coil Group					
		Low Pressure Control	See Coil Group					
61		Integrated Furnace Control Board (IFC)	47-102884-01	47-102884-01	47-102884-01	47-102884-01	47-102884-01	47-102884-01
62	Stk	Compressor Contactor	42-22464-03 (1)	42-22464-03 (1)	42-22464-01 (2)	42-22464-01 (2)	42-22464-01 (2)	42-22464-01 (2)
<b>WIRING HARNESES:</b>								
		Wiring Harness - Motor #1	See Fan Group					
		Wiring Harness - Motor #2	See Fan Group					
		Wiring Harness - Twist-Loc 12 Pin to 9 Pin	45-102706-05	45-102706-05	45-102706-05	45-102706-05	45-102706-05	45-102706-05
		Plug Harness - Compressor	See Compressor Group					
		Wiring Harness - Main Power	45-42522-09	45-42522-09	45-42522-09	45-42522-09	45-42522-09	45-42522-09
		Bypass Plug - Economizer 12 Pin	AS-61997-55	AS-61997-55	AS-61997-55	AS-61997-55	AS-61997-55	AS-61997-55
		Wiring Harness - 6 Pin to Heater Kit	45-102706-09	45-102706-09	45-102706-09	45-102706-09	45-102706-09	45-102706-09
		High/Low Pressure Switch Assembly (Includes both switches and Wiring Harness)	See Coil Group					

No.	Notes	MODEL COOLING CAPACITY VARIATION	PCG 072/073 A-4L	PCG 085 A-4L	PCG 090 A-4L	PCG 102 A-4L	PCG 120 A-4L	PCG 150 A-4L
<b>ELECTRIC GROUP</b>								
11		Terminal Block	45-41669-01	45-41669-01	45-41669-01	45-41669-01	45-41669-01	45-41669-01
<b>CONTROL BOX COMPONENTS:</b>								
57	Stk	Transformer - Control	46-42515-05	46-42515-05	46-42515-05	46-42515-05	46-42515-05	46-42515-05
58a		Double Row Terminal Block	45-42548-02	45-42548-02	45-42548-02	45-42548-02	45-42548-02	45-42548-02
58b		Ground Lug	45-19000-02	45-19000-02	45-19000-02	45-19000-02	45-19000-02	45-19000-02
59	Stk	Contactora - Blower	42-22464-01	42-22464-01	42-22464-01	42-22464-01	42-22464-01	42-22464-01
60		Capacitor - Fan Motor	See Fan Group					
		High Pressure Control	See Coil Group					
		Low Pressure Control	See Coil Group					
61		Integrated Furnace Control Board (IFC)	47-102884-01	47-102884-01	47-102884-01	47-102884-01	47-102884-01	47-102884-01
62	Stk	Compressor Contactor	42-22464-03 (1)	42-22464-03 (1)	42-22464-01 (2)	42-22464-01 (2)	42-22464-01 (2)	42-22464-01 (2)
<b>WIRING HARNESES:</b>								
		Wiring Harness - Motor #1	See Fan Group					
		Wiring Harness - Motor #2	See Fan Group					
		Wiring Harness - Twist-Loc 12 Pin to 9 Pin	45-102706-05	45-102706-05	45-102706-05	45-102706-05	45-102706-05	45-102706-05
		Plug Harness - Compressor	See Compressor Group					
		Wiring Harness - Main Power	45-42522-09	45-42522-09	45-42522-09	45-42522-09	45-42522-09	45-42522-09
		Bypass Plug - Economizer 12 Pin	AS-61997-55	AS-61997-55	AS-61997-55	AS-61997-55	AS-61997-55	AS-61997-55
		Wiring Harness - 6 Pin to Heater Kit	45-102706-09	45-102706-09	45-102706-09	45-102706-09	45-102706-09	45-102706-09
		High/Low Pressure Switch Assembly (Includes both switches and Wiring Harness)	See Coil Group					

No.	Notes	MODEL COOLING CAPACITY VARIATION	PCG 151 A-3L
<b>ELECTRIC GROUP</b>			
11		Terminal Block	45-41669-01
<b>CONTROL BOX COMPONENTS:</b>			
57	Stk	Transformer - Control	46-42515-04
58a		Double Row Terminal Block	45-42548-02
58b		Ground Lug	45-19000-02
59	Stk	Contactator - Blower	42-22464-01
60		Capacitor - Fan Motor	See Fan Group
		High Pressure Control	See Coil Group
		Low Pressure Control	
61		Integrated Furnace Control Board (IFC)	47-102884-01
62	Stk	Compressor Contactator	42-22464-01 (2)
<b>WIRING HARNESES:</b>			
		Wiring Harness - Motor #1	See Fan Group
		Wiring Harness - Motor #2	
		Wiring Harness - Twist-Loc 12 Pin to 9 Pin	45-102706-05
		Plug Harness - Compressor	See Compressor Group
		Wirng Harness - Main Power	45-42522-09
		Bypass Plug - Economizer 12 Pin	AS-61997-55
		Wiring Harness - 6 Pin to Heater Kit	45-102706-09
		High/Low Pressure Switch Assembly (Includes both switches and Wiring Harness)	See Coil Group

No.	Notes	MODEL COOLING CAPACITY VARIATION	PCG 151 A-4L
<b>ELECTRIC GROUP</b>			
11		Terminal Block	45-41669-01
<b>CONTROL BOX COMPONENTS:</b>			
57	Stk	Transformer - Control	46-42515-05
58a		Double Row Terminal Block	45-42548-02
58b		Ground Lug	45-19000-02
59	Stk	Contactator - Blower	42-22464-01
60		Capacitor - Fan Motor	See Fan Group
		High Pressure Control	See Coil Group
		Low Pressure Control	
61		Integrated Furnace Control Board (IFC)	47-102884-01
62	Stk	Compressor Contactator	42-22464-01 (2)
<b>WIRING HARNESES:</b>			
		Wiring Harness - Motor #1	See Fan Group
		Wiring Harness - Motor #2	
		Wiring Harness - Twist-Loc 12 Pin to 9 Pin	45-102706-05
		Plug Harness - Compressor	See Compressor Group
		Wirng Harness - Main Power	45-42522-09
		Bypass Plug - Economizer 12 Pin	AS-61997-55
		Wiring Harness - 6 Pin to Heater Kit	45-102706-09
		High/Low Pressure Switch Assembly (Includes both switches and Wiring Harness)	See Coil Group

No.	Notes	MODEL COOLING CAPACITY VARIATION	PCG 180/210 A-3L	PCG 240 A-3L	PCG 300 A-3L
<b>ELECTRIC GROUP</b>					
11		Terminal Block - Heater Compartment	45-21134-04	45-21134-04	45-21134-04
15		Ground Lug - Heater Compartment	45-19000-02	45-19000-02	45-19000-02
<b>CONTROL BOX COMPONENTS:</b>					
57	Stk	Transformer - Control	46-42515-04	46-42515-04	46-42515-04
58a		Terminal Block - Double Row	45-42548-02	45-42548-02	45-42548-02
58b		Terminal Block - Power Block	45-41765-01	45-41765-01	45-41765-01
58c		Ground Lug	45-19000-02	45-19000-02	45-19000-02
59	Stk	Contactora - Blower	42-102664-08	42-102664-08	42-102664-08
60		Run Capacitor		See Fan Group	
		High Pressure Control		See Coil Group	
		Low Pressure Control		See Coil Group	
61		Integrated Furnace Control	47-102884-01	47-102884-01	47-102884-01
62	Stk	Compressor Contactor (2)	42-102664-12	42-22464-04	42-22464-04
<b>WIRING HARNESES:</b>					
		Wiring Harness - Motor #1		See Fan Group	
		Wiring Harness - Motor #2		See Fan Group	
		Plug Harness - Compressor		See Compressor Group	
		Wirng Harness - Main Power	45-42522-92	45-42522-92	45-42522-92
		Bypass Plug - Economizer 12 Pin	AS-61997-55	AS-61997-55	AS-61997-55
		Wiring Harness - 6 Pin to Heater Kit	45-42522-91	45-42522-91	45-42522-91
		Wiring Harness - Economizer (12 pin to 9 pin)	45-42522-89	45-42522-89	45-42522-89
		High/Low Pressure Switch Assembly (Includes both Switches and Wiring Harness)		See Coil Group	

No.	Notes	MODEL COOLING CAPACITY VARIATION	PCG 180/210 A-4L	PCG 240 A-4L	PCG 300 A-4L
<b>ELECTRIC GROUP</b>					
11		Terminal Block - Heater Compartment	45-21134-04	45-21134-04	45-21134-04
15		Ground Lug - Heater Compartment	45-19000-02	45-19000-02	45-19000-02
<b>CONTROL BOX COMPONENTS:</b>					
57	Stk	Transformer - Control	46-42515-05	46-42515-05	46-42515-05
58a		Terminal Block - Double Row	45-42548-02	45-42548-02	45-42548-02
58b		Terminal Block - Power Block	45-41765-01	45-41765-01	45-41765-01
58c		Ground Lug	45-19000-02	45-19000-02	45-19000-02
59	Stk	Contactora - Blower	42-22464-01	42-22464-01	42-22464-01
60		Run Capacitor		See Fan Group	
		High Pressure Control		See Coil Group	
		Low Pressure Control		See Coil Group	
61		Integrated Furnace Control	47-102884-01	47-102884-01	47-102884-01
62	Stk	Compressor Contactor (2)	42-22464-02	42-22464-02	42-22464-04
<b>WIRING HARNESES:</b>					
		Wiring Harness - Motor #1		See Fan Group	
		Wiring Harness - Motor #2		See Fan Group	
		Plug Harness - Compressor		See Compressor Group	
		Wirng Harness - Main Power	45-42522-92	45-42522-92	45-42522-92
		Bypass Plug - Economizer 12 Pin	AS-61997-55	AS-61997-55	AS-61997-55
		Wiring Harness - 6 Pin to Heater Kit	45-42522-91	45-42522-91	45-42522-91
		Wiring Harness - Economizer (12 pin to 9 pin)	45-42522-89	45-42522-89	45-42522-89
		High/Low Pressure Switch Assembly (Includes both Switches and Wiring Harness)		See Coil Group	

No.	Notes	MODEL COOLING CAPACITY VARIATION	PCG 072/073 A-3L	PCG 085 A-3L	PCG 090 A-3L	PCG 102 A-3L	PCG 120 A-3L
<b>FAN GROUP</b>							
52	Stk	Fan Motor (2)	51-42534-24	51-42534-24	51-42534-24	51-42534-24	51-42534-24
		Wiring Harness - Motor #1 (7 wire)	45-102706-01	45-102706-01	45-102706-01	45-102706-01	45-102706-01
		Wiring Harness - Motor #2 (5 wire)	45-102706-02	45-102706-02	45-102706-02	45-102706-02	45-102706-02
53	Stk	Fan Blade (2)	70-42572-04	70-42572-04	70-42572-04	70-42572-04	70-42572-04
60	Stk	Capacitor - Fan Motor (2)	43-100496-12	43-100496-12	43-100496-12	43-100496-12	43-100496-12

No.	Notes	MODEL COOLING CAPACITY VARIATION	PCG 072/073 A-4L	PCG 085 A-4L	PCG 090 A-4L	PCG 102 A-4L	PCG 120 A-4L
<b>FAN GROUP</b>							
52	Stk	Fan Motor (2)	51-42534-25	51-42534-25	51-42534-25	51-42534-25	51-42534-25
		Wiring Harness - Motor #1 (7 wire)	45-102706-01	45-102706-01	45-102706-01	45-102706-01	45-102706-01
		Wiring Harness - Motor #2 (5 wire)	45-102706-02	45-102706-02	45-102706-02	45-102706-02	45-102706-02
53	Stk	Fan Blade (2)	70-42572-04	70-42572-04	70-42572-04	70-42572-04	70-42572-04
60	Stk	Capacitor - Fan Motor (2)	43-100496-12	43-100496-12	43-100496-12	43-100496-12	43-100496-12

No.	Notes	MODEL COOLING CAPACITY VARIATION				PCG 150 A-3L	PCG 151 A-3L
<b>FAN GROUP</b>							
52	Stk	Fan Motor (2)				51-42534-29	51-42534-29
		Wiring Harness - Motor #1 (7 wire)				45-102706-03	45-102706-03
		Wiring Harness - Motor #2 (5 wire)				45-102706-04	45-102706-04
53	Stk	Fan Blade (2)				70-42502-03	70-103693-01
60	Stk	Capacitor - Fan Motor (2)				43-100496-17	43-100496-17

No.	Notes	MODEL COOLING CAPACITY VARIATION				PCG 150 A-4L	PCG 151 A-4L
<b>FAN GROUP</b>							
52	Stk	Fan Motor (2)				51-42534-28	51-42534-28
		Wiring Harness - Motor #1 (7 wire)				45-102706-03	45-102706-03
		Wiring Harness - Motor #2 (5 wire)				45-102706-04	45-102706-04
53	Stk	Fan Blade (2)				70-42502-03	70-103693-01
60	Stk	Capacitor - Fan Motor (2)				43-100496-12	43-100496-12

No.	Notes	MODEL COOLING CAPACITY VARIATION	PCG 180/210 A-3L	PCG 240 A-3L	PCG 300 A-3L
<b>FAN GROUP</b>					
52	Stk	Fan Motor	51-42534-24 (4)	51-42534-24 (6)	51-42534-24 (6)
		Wiring Harness - Motor #1 & #4	45-42522-71	45-42522-71	45-42522-71
		Wiring Harness - Motor #2 & #5	N/A	45-42522-70	45-42522-70
		Wiring Harness - Motor #3 & #6	45-42522-69	45-42522-69	45-42522-69
53	Stk	Fan Blade	70-42572-04 (4)	70-42572-04 (6)	70-42572-04 (6)
60	Stk	Run Capacitor	43-100496-12 (4)	43-100496-12 (6)	43-100496-12 (6)

No.	Notes	MODEL COOLING CAPACITY VARIATION	PCG 180/210 A-4L	PCG 240 A-4L	PCG 300 A-4L
<b>FAN GROUP</b>					
52	Stk	Fan Motor	51-42534-25 (4)	51-42534-25 (6)	51-42534-25 (6)
		Wiring Harness - Motor #1 & #4	45-42522-71	45-42522-71	45-42522-71
		Wiring Harness - Motor #2 & #5	N/A	45-42522-70	45-42522-70
		Wiring Harness - Motor #3 & #6	45-42522-69	45-42522-69	45-42522-69
53	Stk	Fan Blade	70-42572-04 (4)	70-42572-04 (6)	70-42572-04 (6)
60	Stk	Run Capacitor	43-100496-12 (4)	43-100496-12 (6)	43-100496-12 (6)

No.	Notes	MODEL COOLING CAPACITY VARIATION	PCG 072/073 A-3L / A-4L	PCG 085 A-3L / A-4L	PCG 090 A-3L / A-4L	PCG 102 A-3L / A-4L	PCG 120 A-3L / A-4L	PCG 150 A-3L / A-4L
<b>BLOWER ASSEMBLY GROUP - BELT DRIVE</b>								
64	Stk	Blower Assembly (w/o Motor Mount, Belt, Fixed Sheave, and Key)	AS-102711-02	AS-90757-01	AS-90757-01	AS-90757-01	AS-90757-01	AS-90757-01
65	Stk	Blower Wheel	70-21773-01	70-42540-02	70-42540-02	70-42540-02	70-42540-02	70-42540-02
66		Bearing Frame Tri-Arm (2)	70-41723-02	70-42540-05	70-42540-05	70-42540-05	70-42540-05	70-42540-05
67		Bearing with Bearing Lock (2)	70-41911-01	70-41854-02	70-41854-02	70-41854-02	70-41854-02	70-41854-02
68	Stk	Blower Shaft	70-21933-02	70-42540-04	70-42540-04	70-42540-04	70-42540-04	70-42540-04
69		Blower Mounting Angles (2)	AE-90708-01	AE-90708-01	AE-90708-01	AE-90708-01	AE-90708-01	AE-90708-01
		Blower Angle Stop	AE-90709-02	AE-90709-02	AE-90709-02	AE-90709-02	AE-90709-02	AE-90709-02
70		Motor Mount	AE-90710-05	AE-90710-04	AE-90710-04	AE-90710-04	AE-90710-04	AE-90710-04
71	Stk	Blower Motor - C/D Voltages	51-41936-03	51-42536-01	51-42536-01	51-42537-01	51-42537-01	51-42498-07
72	Stk	Variable Sheave	71-40427-25	71-42538-02	71-42538-02	71-42538-02	71-42538-02	71-40427-11
73	Stk	Belt	71-40235-48	71-40438-27	71-40438-27	71-40438-23	71-40438-23	71-40438-31
74	Stk	Fixed Sheave	71-100772-03	71-100774-02	71-100774-02	71-100774-04	71-100774-04	71-26254-06
		Key	94-22030-01	94-42551-09	94-42551-09	94-42551-09	94-42551-09	94-42551-09
	Stk	Bushing for Sheave w/Screws	N/A	71-100773-01	71-100773-01	71-100773-01	71-100773-01	71-100773-01

No.	Notes	MODEL COOLING CAPACITY VARIATION						PCG 151 A-3L / A-4L
<b>BLOWER ASSEMBLY GROUP - BELT DRIVE</b>								
64	Stk	Blower Assembly (w/o Motor Mount, Belt, Fixed Sheave, and Key)						AS-90757-01
65	Stk	Blower Wheel						70-42540-02
66		Bearing Frame Tri-Arm (2)						70-42540-05
67		Bearing with Bearing Lock (2)						70-41854-02
68	Stk	Blower Shaft						70-42540-04
69		Blower Mounting Angles (2)						AE-90708-01
		Blower Angle Stop						AE-90709-02
70		Motor Mount						AE-90710-04
71	Stk	Blower Motor - C/D Voltages						51-102826-06
72	Stk	Variable Sheave						71-40427-11
73	Stk	Belt						71-40438-31
74	Stk	Fixed Sheave						71-26254-06
		Key						94-42551-09
	Stk	Bushing for Sheave w/Screws						71-100773-01

No.	Notes	MODEL COOLING CAPACITY VARIATION	PCG 180/210 A-3L / A-4L	PCG 240 A-3L / A-4L	PCG 300 A-3L / A-4L
<b>BLOWER ASSEMBLY GROUP - BELT DRIVE</b>					
64	Stk	Blower Assembly (includes Bearing Frame and Blower Wheel) (2)	AS-90757-06	AS-90757-06	AS-90757-06
65	Stk	Blower Wheel (2)	70-42564-02	70-42564-02	70-42564-02
66		Bearing Frame Tri-Arm (4)	70-42284-04	70-42284-04	70-42284-04
67		Bearing with Bearing Lock (4)	70-41854-02	70-41854-02	70-41854-02
68	Stk	Blower Shaft	70-42564-03	70-42564-03	70-42564-03
69		Blower Connector Angles (3)	AE-90798-01	AE-90798-01	AE-90798-01
70		Motor Mount	AE-90710-03	AE-90710-03	AE-90710-03
71	Stk	Blower Motor - C/D Voltages	51-102826-01	51-102826-02	51-102826-03
72	Stk	Variable Sheave	71-40427-04	71-40427-59	71-40427-60
73	Stk	Belt	71-40438-46	71-40438-54	71-102847-01
74a	Stk	Fixed Sheave	71-100774-08	71-100774-06	71-100774-07
74b		Key	94-42551-09	94-42551-09	94-42551-09
74c	Stk	Bushing for Sheave w/Screws	71-100773-01	71-100773-01	71-100773-01

No.	Notes	MODEL COOLING CAPACITY VARIATION	PCG	PCG	PCG	PCG
			072 A-3L / A-4L	073 A-3L / A-4L	085 A-3L / A-4L	090 A-3L / A-4L
<b>COIL GROUP</b>						
<b>EVAPORATOR COIL GROUP:</b>						
42	Stk	Evaporator Coil	AS-90656-70	AS-90656-88	AS-90656-76	AS-90656-68
	Stk	Distributor / Flowcheck Piston Assembly	61-102809-94	N/A	61-102912-98	N/A
	Stk	Flowcheck Piston Kit	61-25414-94	N/A	N/A	N/A
	Stk	Flowcheck Distributor	61-26113-35	N/A	N/A	N/A
		TXV - Circuit #1	N/A	61-101351-13	N/A	61-101351-11
		TXV - Circuit #2	N/A	N/A	N/A	61-101351-11
		Bulb Strap Kit - TXV (2)	N/A	N/A	N/A	64-101357-01
43	Stk	Drain Pan - Removable	68-102699-02	68-102699-02	68-102699-02	68-102699-02
<b>FILTER PIECES:</b>						
44		Filter Frame	AE-90606-11	AE-90606-11	AE-90606-11	AE-90606-11
45		Air Stop - Bottom	AE-102712-10	AE-102712-10	AE-102712-10	AE-102712-10
46		Air Stop - Side	AE-102712-06	AE-102712-06	AE-102712-06	AE-102712-06
47		Top Air Stop Assembly	AS-90604-06	AS-90604-06	AS-90604-06	AS-90604-06
48		Filter Channel (2)	AE-102712-08	AE-102712-08	AE-102712-08	AE-102712-08
49		Filter Slide (2)	AE-102712-11	AE-102712-11	AE-102712-11	AE-102712-11
50		Filter (6)	54-42541-01	54-42541-01	54-42541-01	54-42541-01
<b>CONDENSER COIL:</b>						
37a	Stk	Condenser Coil	AS-102704-03	AS-102704-03	AS-102704-03	AS-102704-03
37b	Stk	Condenser Coil	N/A	N/A	AS-102839-03	AS-102704-03
38		Front Air Stop	AE-90706-19	AE-90706-19	AE-90706-19	AE-90706-19
39		Rear Air Stop	AE-90706-18	AE-90706-18	AE-90706-18	AE-90706-18
40a,b		Bottom Retainer (2)	N/A	N/A	N/A	AE-90700-03
40a		Micro-Channel Coil Mounting Base - Left	N/A	N/A	N/A	N/A
40b		Micro-Channel Coil Mounting Base - Right	N/A	N/A	N/A	N/A
41a		Top Support - Condenser Coil	N/A	N/A	AE-90612-09	AE-90612-09
41b		Top Support - Condenser Bulkhead	N/A	N/A	AE-90612-19	AE-90612-03
		Filter Drier - Liquid Line	83-22755-05 (1)	83-22755-05 (1)	83-40386-07 (1)	83-22755-05 (2)
		Strap - Filter Drier	N/A	N/A	N/A	AE-102132-01 (2)
	Stk	High Pressure Control	47-23699-05	47-23699-05	47-23699-05	47-23699-05
	Stk	Low Pressure Control - Before F2710	47-101529-05 (1)	N/A	47-101529-05 (1)	47-101529-05 (2)
	Stk	Low Pressure Control - After F2710	47-101529-09 (1)	47-101529-09 (1)	47-101529-09 (1)	47-101529-09 (2)
		High/Low Pressure Switch Assembly (Includes both switches and Wiring Harness)	AS-102877-01	AS-102877-01	AS-102877-01	AS-102877-01

No.	Notes	MODEL COOLING CAPACITY VARIATION	PCG	PCG	PCG
			102 A-3L / A-4L	120 A-3L / A-4L	150 A-3L / A-4L
<b>COIL GROUP</b>					
<b>EVAPORATOR COIL GROUP:</b>					
42	Stk	Evaporator Coil	AS-90656-77	AS-90656-69	AS-90656-75
	Stk	Distributor / Flowcheck Piston Assembly	N/A	N/A	N/A
	Stk	Flowcheck Piston Kit	N/A	N/A	N/A
	Stk	Flowcheck Distributor	N/A	N/A	N/A
		TXV - Circuit #1	61-101351-12	61-101351-13	61-101351-14
		TXV - Circuit #2	61-101351-12	61-101351-13	61-101351-14
		Bulb Strap Kit - TXV (2)	64-101357-01	64-101357-01	64-101357-01
43	Stk	Drain Pan - Removable	68-102699-02	68-102699-02	68-102699-02
<b>FILTER PIECES:</b>					
44		Filter Frame	AE-90606-11	AE-90606-11	AE-90606-11
45		Air Stop - Bottom	AE-102712-10	AE-102712-10	AE-102712-10
46		Air Stop - Side	AE-102712-06	AE-102712-06	AE-102712-06
47		Top Air Stop Assembly	AS-90604-06	AS-90604-06	AS-90604-06
48		Filter Channel (2)	AE-102712-08	AE-102712-08	AE-102712-08
49		Filter Slide (2)	AE-102712-11	AE-102712-11	AE-102712-11
50		Filter (6)	54-42541-01	54-42541-01	54-42541-01
<b>CONDENSER COIL:</b>					
37a	Stk	Condenser Coil	AS-90656-25	AS-90656-42	65-101478-01
37b	Stk	Condenser Coil	AS-90656-25	AS-90656-42	65-101478-01
38		Front Air Stop	AE-90706-19	AE-90706-19	N/A
39		Rear Air Stop	AE-90706-18	AE-90706-18	N/A
40a,b		Bottom Retainer (2)	AE-90700-02	AE-90700-02	N/A
40a		Micro-Channel Coil Mounting Base - Left	N/A	N/A	68-102752-01
40b		Micro-Channel Coil Mounting Base - Right	N/A	N/A	68-102752-02
41a		Top Support - Condenser Coil	AE-90612-02	AE-90612-02	AE-90612-13
41b		Top Support - Condenser Bulkhead	AE-90612-03	AE-90612-03	AE-90612-05
		Filter Drier - Liquid Line	83-22755-05 (2)	83-22755-05 (2)	83-22755-05 (2)
		Strap - Filter Drier	AE-102132-01 (2)	AE-102132-01 (2)	AE-102132-01 (2)
	Stk	High Pressure Control	47-23699-05	47-23699-05	47-23699-05
	Stk	Low Pressure Control - Before F2710	47-101529-05 (2)	47-101529-05 (2)	47-101529-05 (2)
	Stk	Low Pressure Control - After F2710	47-101529-09 (2)	47-101529-09 (2)	47-101529-09 (2)
		High/Low Pressure Switch Assembly (Includes both switches and Wiring Harness)	AS-102877-01	AS-102877-01	AS-102877-01

No.	Notes	MODEL COOLING CAPACITY VARIATION	PCG 151 A-3L / A-4L
<b>COIL GROUP</b>			
<b>EVAPORATOR COIL GROUP:</b>			
42	Stk	Evaporator Coil	AS-90656-75
	Stk	Distributor / Flowcheck Piston Assembly	N/A
	Stk	Flowcheck Piston Kit	N/A
	Stk	Flowcheck Distributor	N/A
		TXV - Circuit #1	61-101351-14
		TXV - Circuit #2	61-101351-14
		Bulb Strap Kit - TXV (2)	64-101357-01
43	Stk	Drain Pan - Removable	68-102699-02
<b>FILTER PIECES:</b>			
44		Filter Frame	AE-90606-11
45		Air Stop - Bottom	AE-102712-10
46		Air Stop - Side	AE-102712-06
47		Top Air Stop Assembly	AS-90604-06
48		Filter Channel (2)	AE-102712-08
49		Filter Slide (2)	AE-102712-11
50		Filter (6)	54-42541-01
<b>CONDENSER COIL:</b>			
37a	Stk	Condenser Coil	65-101478-01
37b	Stk	Condenser Coil	65-101478-01
38		Front Air Stop	N/A
39		Rear Air Stop	N/A
40a,b		Bottom Retainer (2)	N/A
40a		Micro-Channel Coil Mounting Base - Left	68-102752-01
40b		Micro-Channel Coil Mounting Base - Right	68-102752-02
41a		Top Support - Condenser Coil	AE-90612-13
41b		Top Support - Condenser Bulkhead	AE-90612-05
		Filter Drier - Liquid Line	83-22755-05 (2)
		Strap - Filter Drier	AE-102132-01 (2)
	Stk	High Pressure Control	47-23699-05
	Stk	Low Pressure Control - Before F2710	47-101529-05 (2)
	Stk	Low Pressure Control - After F2710	47-101529-09 (2)
		High/Low Pressure Switch Assembly (Includes both switches and Wiring Harness)	AS-102877-01

No.	Notes	MODEL COOLING CAPACITY VARIATION	PCG	PCG	PCG	PCG
			180 A-3L / A-4L	210 A-3L / A-4L	240 A-3L / A-4L	300 A-3L / A-4L
<b>COIL GROUP</b>						
<b>EVAPORATOR COIL GROUP:</b>						
40		Air Flow Panel	AS-90828-02C	AS-90828-02C	AS-90828-02C	AS-90828-02C
42	Stk	Complete Coil - Indoor	AS-102821-03	AS-102821-03	AS-102652-03	AS-102428-03
	Stk	TXV/Distributor Assembly - Circuit #1	61-102845-01	61-102845-01	61-102687-01	61-102815-01
	Stk	TXV/Distributor Assembly - Circuit #2	61-102845-01	61-102845-01	61-102687-01	61-102815-01
43	Stk	Drain Pan - Removable	68-102699-01	68-102699-01	68-102699-01	68-102699-01
<b>FILTER PIECES:</b>						
44		Filter Frame	AE-90606-10	AE-90606-10	AE-90606-10	AE-90606-10
45	1	Air Stop - Bottom (Before F1811) - See Note 1	AE-102712-05	AE-102712-05	AE-102712-05	AE-102712-05
45		Air Stop - Bottom (After F1811)	AE-102712-17	AE-102712-17	AE-102712-17	AE-102712-17
46	1	Air Stop - Side (Before F1811) - See Note 1	AE-102712-01	AE-102712-01	AE-102712-01	AE-102712-01
46		Air Stop - Side (After F1811)	AE-102712-14	AE-102712-14	AE-102712-14	AE-102712-14
47		Top Air Stop Assembly	AS-90604-04	AS-90604-04	AS-90604-04	AS-90604-04
48	1	Filter Channel (2) (Before F1811) - See Note 1	AE-102712-03	AE-102712-03	AE-102712-03	AE-102712-03
48		Filter Channel (2) (After F1811)	AE-102712-16	AE-102712-16	AE-102712-16	AE-102712-16
49	1	Filter Slide (2) (Before F1811) - See Note 1	AE-102712-02	AE-102712-02	AE-102712-02	AE-102712-02
49		Filter Slide (2) (After F1811)	AE-102712-15	AE-102712-15	AE-102712-15	AE-102712-15
50		Filter - 20 in. x 25 in. x 2 in. (8)	54-42541-04	54-42541-04	54-42541-04	54-42541-04
<b>CONDENSER COIL:</b>						
37	Stk	Condenser Coil Assembly (2)	AS-102647-03	AS-103204-03	AS-102666-03	AS-102666-03
38a		Air Stop - Front	AE-90706-13	AE-90706-13	AE-90706-13	AE-90706-13
38b		Corner Brace - Top Front	AS-90706-16C	AS-90706-16C	AS-90706-16C	AS-90706-16C
38c		Post - Front	AS-90706-14C	AS-90706-14C	AS-90706-14C	AS-90706-14C
39a		Air Stop - Rear	AE-90706-12	AE-90706-12	AE-90706-12	AE-90706-12
39b		Corner Brace - Top Rear	AS-90706-17C	AS-90706-17C	AS-90706-17C	AS-90706-17C
39c		Post - Rear	AS-90706-15C	AS-90706-15C	AS-90706-15C	AS-90706-15C
41		Air Stop- Top Right	AS-90753-08C	AS-90753-08C	AS-90753-08C	AS-90753-08C
41a		Top Support - Inner Condenser Coil (2)	AE-90612-21	AE-90612-08	AE-90612-08	AE-90612-08
41b		Top Support - Outer Condenser Coil	AE-90612-20	AE-90612-11	AE-90612-11	AE-90612-11
41c		Top Support - Condenser Bulkhead	AE-90612-18	AE-90612-06	AE-90612-06	AE-90612-06
		Filter Drier - Liquid Line (2)	83-22755-11	83-22755-11	83-22755-11	83-22755-11
	Stk	High Pressure Control	47-23699-05	47-23699-05	47-23699-05	47-23699-05
	Stk	Low Pressure Control - Before F2710	47-101529-05 (2)	47-101529-05 (2)	47-101529-05 (2)	47-101529-05 (2)
	Stk	Low Pressure Control - After F2710	47-101529-09 (2)	47-101529-09 (2)	47-101529-09 (2)	47-101529-09 (2)
		High/Low Pressure Switch Assembly (Includes both Switches and Wiring Harness)	AS-102877-01	AS-102877-01	AS-102877-01	AS-102877-01

No.	Notes	MODEL COOLING CAPACITY VARIATION	PCG 072 A-3L	PCG 073 A-3L	PCG 085 A-3L	PCG 090 A-3L	PCG 102 A-3L	PCG 120 A-3L
<b>COMPRESSOR GROUP</b>								
		<b>Compressor ID:</b>	<b>7916</b>	<b>8597</b>	<b>7910</b>	<b>7897</b>	<b>7940</b>	<b>7946</b>
75	Stk	Compressor	55-102045-37S	55-102471-21S	55-102045-43S	55-102045-08S	55-102045-34S	55-102045-27S
75	Stk	Compressor	N/A	N/A	N/A	55-102045-08S	55-102045-34S	55-102045-27S
	Stk	Cranckcase Heater	44-17402-10	44-17402-10	44-17402-10	N/A	N/A	N/A
		Plug Harness - Compressor	45-102708-01	45-102708-01	45-102708-01	45-102708-01	45-102708-01	45-102708-01
		Plug Harness - Compressor	N/A	N/A	N/A	45-102708-02	45-102708-02	45-102708-02

No.	Notes	MODEL COOLING CAPACITY VARIATION	PCG 072 A-4L	PCG 073 A-4L	PCG 085 A-4L	PCG 090 A-4L	PCG 102 A-4L	PCG 120 A-4L
<b>COMPRESSOR GROUP</b>								
		<b>Compressor ID:</b>	<b>7917</b>	<b>8598</b>	<b>7911</b>	<b>7898</b>	<b>7941</b>	<b>7947</b>
75	Stk	Compressor	55-102045-38S	55-102471-22S	55-102045-45S	55-102045-07S	55-102045-35S	55-102045-28S
75	Stk	Compressor	N/A	N/A	N/A	55-102045-07S	55-102045-35S	55-102045-28S
	Stk	Cranckcase Heater	44-17402-11	44-17402-11	44-17402-11	N/A	N/A	N/A
		Plug Harness - Compressor	45-102708-01	45-102708-01	45-102708-01	45-102708-01	45-102708-01	45-102708-01
		Plug Harness - Compressor	N/A	N/A	N/A	45-102708-02	45-102708-02	45-102708-02

No.	Notes	MODEL COOLING CAPACITY VARIATION					PCG 150 A-3L	PCG 151 A-3L
<b>COMPRESSOR GROUP</b>								
		<b>Compressor ID:</b>					<b>7900</b>	<b>8306</b>
75	Stk	Compressor					55-102471-14S	55-102471-14S
75	Stk	Compressor					55-102471-18S	55-102471-18S
		Plug Harness - Compressor					45-102708-03	45-102708-03
		Plug Harness - Compressor					45-102708-04	45-102708-04

No.	Notes	MODEL COOLING CAPACITY VARIATION					PCG 150 A-4L	PCG 151 A-4L
<b>COMPRESSOR GROUP</b>								
		<b>Compressor ID:</b>					<b>7901</b>	<b>8307</b>
75	Stk	Compressor					55-102471-16S	55-102471-16S
75	Stk	Compressor					55-102471-19S	55-102471-19S
		Plug Harness - Compressor					45-102708-03	45-102708-03
		Plug Harness - Compressor					45-102708-04	45-102708-04

No.	Notes	MODEL COOLING CAPACITY VARIATION	PCG 180 A-3L	PCG 210 A-3L	PCG 240 A-3L	PCG 300 A-3L
<b>COMPRESSOR GROUP</b>						
		<b>Compressor:</b>	<b>7882</b>	<b>8053</b>	<b>7885</b>	<b>7888</b>
75	Stk	Compressor	55-23156-20S	55-102471-03S	55-102471-02S	55-102471-13S
75	Stk	Compressor	55-23156-20S	55-102471-03S	55-102471-03S	55-102471-13S
		Plug Harness - Compressor #1	45-42522-72	45-42522-72	45-42522-72	45-42522-72
		Plug Harness - Compressor #2	45-42522-73	45-42522-73	45-42522-73	45-42522-73
		High Pressure Control	47-23699-05	47-23699-05	47-23699-05	47-23699-05
		Low Pressure Control	47-101529-05	47-101529-05	47-101529-05	47-101529-05
		Harness - High/Low Pressure Switch Assembly (includes High and Low Switches)	AS-102877-01	AS-102877-01	AS-102877-01	AS-102877-01

No.	Notes	MODEL COOLING CAPACITY VARIATION	PCG 180 A-4L	PCG 210 A-4L	PCG 240 A-4L	PCG 300 A-4L
<b>COMPRESSOR GROUP</b>						
		<b>Compressor:</b>	<b>7883</b>	<b>8054</b>	<b>7886</b>	<b>7889</b>
75	Stk	Compressor	55-23156-21S	55-102471-07S	55-102471-07S	55-102471-08S
75	Stk	Compressor	55-23156-21S	55-102471-07S	55-102471-09S	55-102471-08S
		Plug Harness - Compressor #1	45-42522-72	45-42522-72	45-42522-72	45-42522-72
		Plug Harness - Compressor #2	45-42522-73	45-42522-73	45-42522-73	45-42522-73
		High Pressure Control	47-23699-05	47-23699-05	47-23699-05	47-23699-05
		Low Pressure Control	47-101529-05	47-101529-05	47-101529-05	47-101529-05
		Harness - High/Low Pressure Switch Assembly (includes High and Low Switches)	AS-102877-01	AS-102877-01	AS-102877-01	AS-102877-01

No.	Notes	MODEL COOLING CAPACITY VARIATION	PCG 072-151 A-3L	PCG 072-151 A-3L	PCG 072-151 A-3L	PCG 072-151 A-3L	PCG 072-151 A-3L
<b>ELECTRIC HEATER KITS</b>							
		Electric Element Kits - Option	RXJJ-CC10C	RXJJ-CC15C	RXJJ-CC20C	RXJJ-CC30C	RXJJ-CC31C
		Electric Element Kits - Option	RXJJ-CC40C	RXJJ-CC41C	RXJJ-CC50C	RXJJ-CC51C	

No.	Notes	MODEL COOLING CAPACITY VARIATION	PCG 072-151 A-4L	PCG 072-151 A-4L	PCG 072-151 A-4L	PCG 072-151 A-4L	PCG 072-151 A-4L
<b>ELECTRIC HEATER KITS</b>							
		Electric Element Kits - Option	RXJJ-CC10D	RXJJ-CC15D	RXJJ-CC20D	RXJJ-CC30D	RXJJ-CC31D
		Electric Element Kits - Option	RXJJ-CC40D	RXJJ-CC50D	RXJJ-CC51D		

No.	Notes	MODEL COOLING CAPACITY VARIATION	PCG 180-300 A-3L	PCG 180-300 A-3L	PCG 180-300 A-3L	PCG 180-300 A-3L	
<b>ELECTRIC HEATER KITS</b>							
		Electric Element Kits - Option	RXJJ-CE20C	RXJJ-CE40C	RXJJ-CE60C	RXJJ-CE75C	

No.	Notes	MODEL COOLING CAPACITY VARIATION	PCG 180-300 A-4L	PCG 180-300 A-4L	PCG 180-300 A-4L	PCG 180-300 A-4L	
<b>ELECTRIC HEATER KITS</b>							
		Electric Element Kits - Option	RXJJ-CE20D	RXJJ-CE40D	RXJJ-CE60D	RXJJ-CE75D	

No.	Notes	MODEL COOLING CAPACITY VARIATION	PCG 072-151 A-3L / A-4L
<b>ACCESSORIES</b>			
		Carbon Dioxide Sensor	RXR-AR02
		Dual Enthalpy Kit	RXR-AV02
		Manual Fresh Air (Left Panel Mounted)	RXRF-KDA1
		Motor Kit for RXRF-KDA1	RXR-AW02
		Manual Fresh Air (Return Panel)	RXRF-JDA1
		Motorized Fresh Air (Return Panel)	RXRF-JDB1
		Time Delay Relay - Option	RXMD-A04
		Freeze Stat - Option	RXR-AM01
		Convenience Outlet - Option	RXR-AN01
		Low Ambient Control Kit (1 Per Compressor)	RXRZ-C02

No.	Notes	MODEL COOLING CAPACITY VARIATION	PCG 072-151 A-3L / A-4L
<b>ECONOMIZERS</b>			
		Economizer - Single Enthalpy	TXRD-PDCM3
		Economizer - Single Enthalpy w/Smoke Detector	TXRD-SDCM3
		Horizontal Economizer - Single Enthalpy	TXRD-RDCM3

No.	Notes	MODEL COOLING CAPACITY VARIATION	PCG 072-151 A-3L / A-4L
<b>POWER EXHAUST</b>			
		Power Exhaust	RXR-BFF02C
		Power Exhaust	RXR-BFF02D

<b>No.</b>	<b>Notes</b>	<b>MODEL TECHNICAL VARIATION COOLING CAPACITY</b>	<b>PCG 180-300 A-3L / A-4L</b>
<b>ACCESSORIES</b>			
		Carbon Dioxide Sensor	RXRX-AR02
		Dual Enthalpy Kit	RXRX-AV02
		Manual Fresh Air Damper	RXRF-KFA1
		Motorized Kit for RXRF-KFA1	RXRX-AW03
		Freeze Stat Kit	RXRX-AM03
		Unwired Convenience Outlet	RXRX-AN01
		Low Ambient Control Kit (1 Per Compressor)	RXRZ-C02

<b>No.</b>	<b>Notes</b>	<b>MODEL TECHNICAL VARIATION COOLING CAPACITY</b>	<b>PCG 180-300 A-3L / A-4L</b>
<b>ECONOMIZERS</b>			
		Downflow Economizer - Single Enthalpy	TXRD-PGCM3
		Downflow Economizer - Single Enthalpy w/Smoke Detector	TXRD-SGCM3
		Horizontal Economizer - Single Enthalpy	TXRD-RGCM3

<b>No.</b>		<b>MODEL TECHNICAL VARIATION COOLING CAPACITY</b>	<b>PCG 180-300 A-3L / A-4L</b>
<b>POWER EXHAUST</b>			
		Power Exhaust	RXRX-BGF05C
		Power Exhaust	RXRX-BGF05D
		Power Exhaust	RXRX-BGF05Y



Exploded View 072-150



Exterior - Front 072-150



Exterior - Back 072-150



Filter-Coil Assembly 072-150

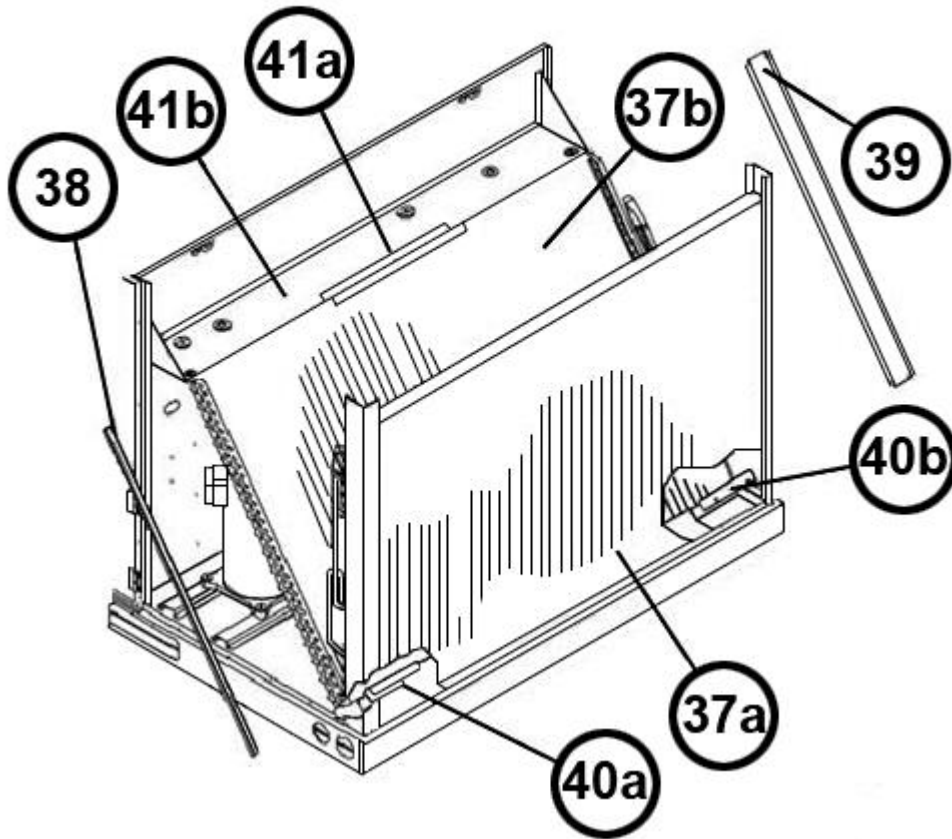

Condenser Coil Assembly 072-150



Front Panel Brackets 072-150



Filter Frame Assembly 072-150

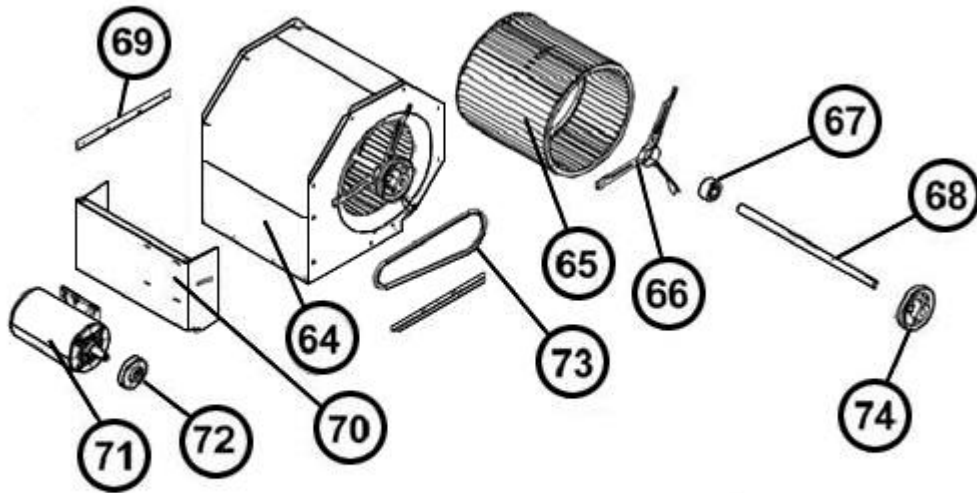

Blower Assembly 072-150



Control Box 072-150



Exterior - Front 180-300



Exterior - Rear 180-300



Base Pan Assembly 180-300



Base Rail Assembly 180-300



Front Panel Brackets 180-300



Interior - Coil 180-300



Heat Compartment 180-300



Condenser Bulkhead 180-300



Filter Frame Assembly 180-300



Blower Assembly 180-300



Control Box 180-300



Electric Heat Block-Off 180-300

# NOTES

Stk It is recommended that stock be maintained for this part.

N/A Not Applicable

- 1 Older (Before F1811) filter frame components are not individually compatible with newer (After F1811) filter frame components. Depending upon availability of older (Before F1811) components, it may be necessary to replace entire filter frame assembly (Air Stops - Bottom and Side, Filter Channels and Filter Slides) with the newer style (After F1811) components.