

This Owner's Manual is provided and hosted by Appliance Factory Parts.

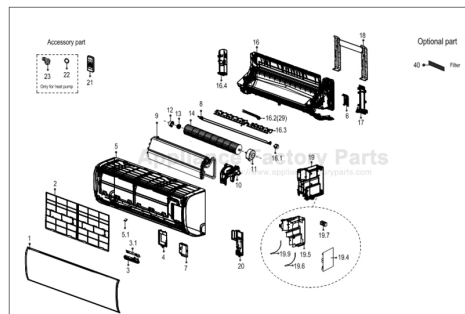

COMFORT-AIRE B-SVH12SA-1 Owner's Manual

[Shop genuine replacement parts for COMFORT-AIRE
B-SVH12SA-1](#)



[Find Your COMFORT-AIRE HVAC Parts - Select From 1486 Models](#)

----- Manual continues below -----

Comfort-Aire®

Century®

MARS®
Delivering Confidence

REPLACEMENT PARTS LIST

**Single Zone Ductless Mini-Split
with Inverter Technology**

B-SVH12SA-1

EXPLODED VIEW

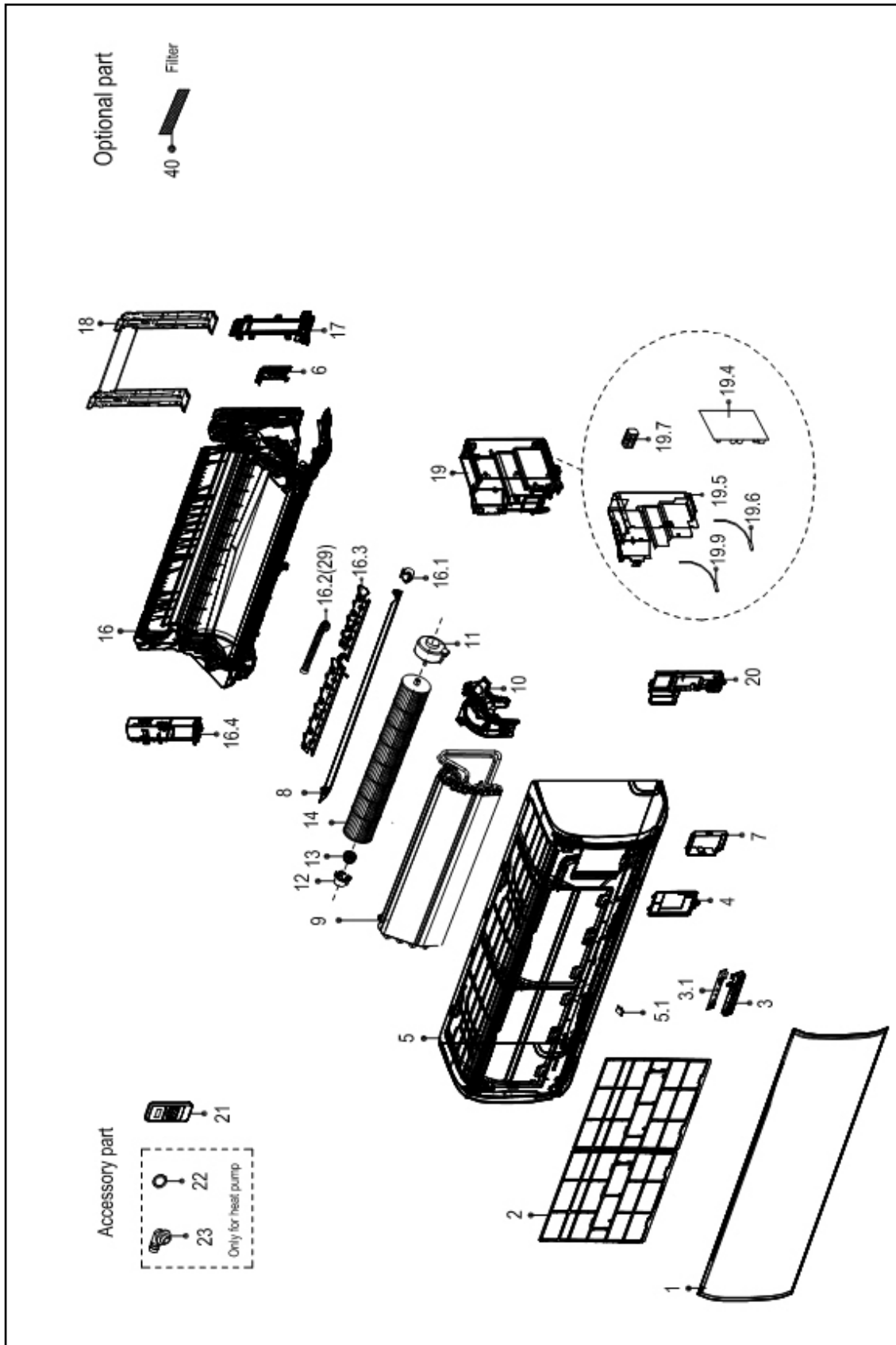

REPLACEMENT PARTS

Location	Part Name	Quantity	Part No.
1	Panel assembly	1	12122000A55313
2	Air filter	2	12122000015224
3	Display box subassembly	1	17222000A27228
3.1	Display board subassembly	1	17122000022008
4	Cover of electrical equipment	1	12122000013131
5	Panel frame assembly	1	12122000013170
5.1	Screw cap	2	12122000013139
6	Front cover of chassis	1	12122000013140
7	Cover of electrical equipment subassembly	1	12122000013141
8	Horizontal louver assembly	1	12122000013168
9	Evaporator assembly	1	15822000005797
10	Fan motor cover	1	12122000013129
11	Single phase asynchronous motor	1	11002012001871
12	Bearing holder	1	12122000000350
13	Bearing base	1	12622000000006
14	Cross flow fan	1	12100102000044
16	Chassis assembly	1	12122000014661
16.1	Stepper motor	1	11002010000143
16.3	Horizontal louver	1	12122000013763
16.4	Front cover of chassis	1	12122000013123
17	Pipe clamp board	1	12122000013136
18	Installation plate	1	12222000A03012
19	Electronic control box subassembly	1	17222000013748
19.4	Main control board subassembly	1	17122000024690
19.5	Electronic control box subassembly	1	12122000013001
19.6	Pipe temperature sensor	1	11201007000322
19.7	Wire joint	1	17400401000006
19.9	Room temperature sensor	1	11201007000088
20	Cover of electronic control box subassembly	1	12122000013132
21	Remote controller	1	17317000A19587
22	Seal ring	1	12600701000039
23	Drain fitting	1	12100509000061
40	Air fresh filter	1	12100207000131

Due to ongoing product improvements, specifications and dimensions are subject to change and correction without notice or incurring obligations. Determining the application and suitability for use of any product is the responsibility of the installer. Additionally, the installer is responsible for verifying dimensional data on the actual product prior to beginning any installation preparations.

Incentive and rebate programs have precise requirements as to product performance and certification. All products meet applicable regulations in effect on date of manufacture; however, certifications are not necessarily granted for the life of a product. Therefore, it is the responsibility of the applicant to determine whether a specific model qualifies for these incentive/rebate programs.

Comfort-Cire® **Century**

1900 Wellworth Ave., Jackson, MI 49203 • Ph. 517-787-2100 • www.marsdelivers.com

