

HEAT CONTROLLER, INC.

REPLACEMENT PARTS LIST

**Room Air Conditioner with R-410A:
BG-143J**

EXPLODED VIEW

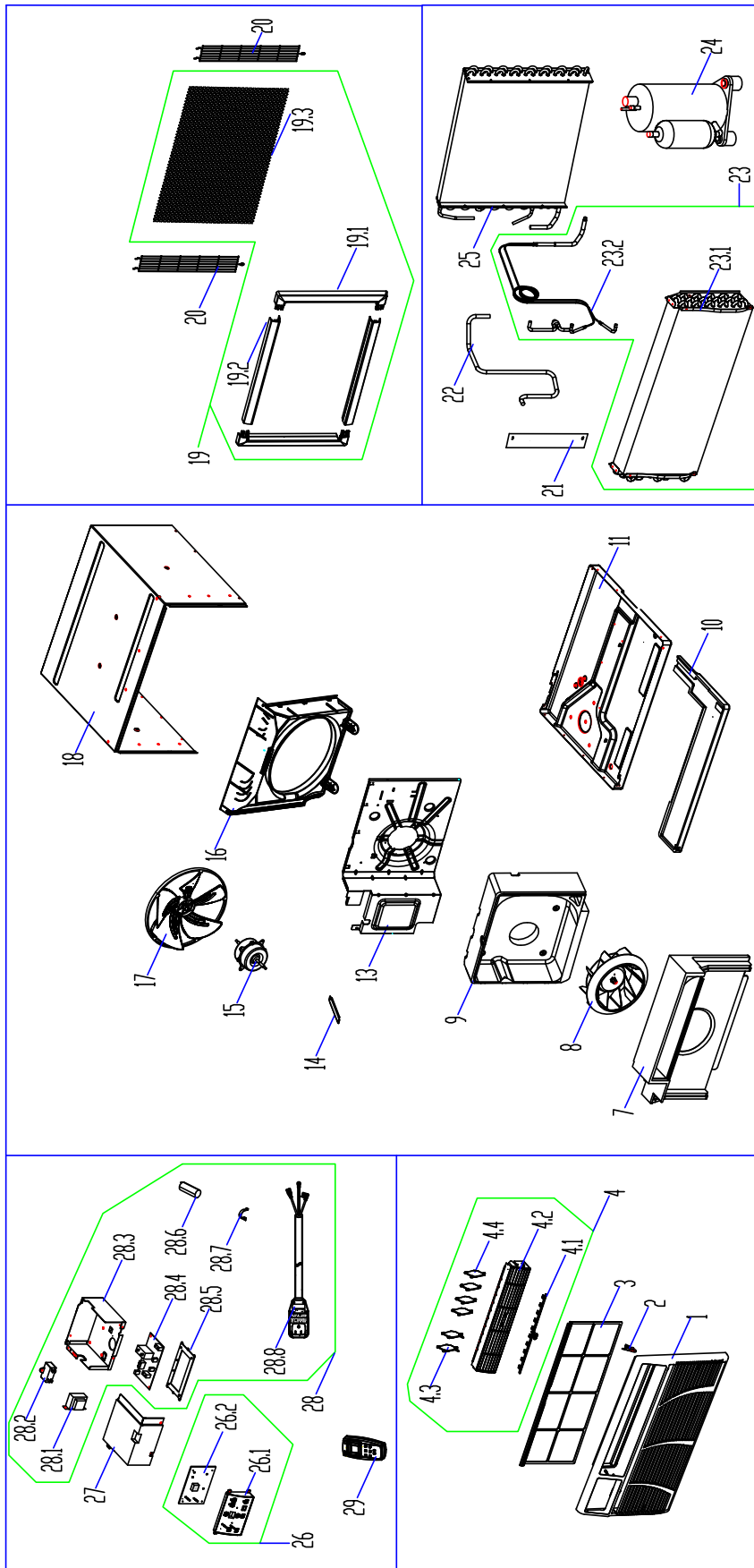

REPLACEMENT PARTS

Location	Part Name	Quantity	Part No.
1	Front panel	1	201121890037
2	Filter guide	2	201121890003
3	Air filter	1	201121890036
4	Air outlet assembly	1	201121890031
4.1	Connecting rod of louver	2	201121890035
4.2	Air outlet assembly	1	201121890043
4.3	Horizontal louver	2	201121890033
4.4	Horizontal louver	4	201121890034
7	Front volute shell	1	202221890013
8	Centrifugal fan	1	201100100028
9	Rear volute shell	1	202221390003
10	Condenser water tray	1	202221890010
11	Chassis assembly	1	201221890062
13	Front separating board	1	201221890033
14	Linker for front separating board	1	201221890034
15	Asynchronous motor	1	202400400954
16	Rear separating	1	201121390106
17	Axial flow fan	1	201100300022
18	Cabinet	1	201221390086
19	Installation accessory	1	202821590016
19.1	Left and right shutter frame	2	201121890008
19.2	Up and down shutter frame	2	201121890007
19.3	Plastic net	1	201121890009
20	Reseau	1	201221390106
20	Reseau	1	201221890078
21	Separating board for power cord	1	201121890017
22	Discharge pipe assembly	1	201621590263
23	Evaporator coil assembly	1	201521890065
23.1	Evaporator	1	201521890049
23.2	Capillary assembly	1	201621890266
24	Compressor	1	201402000610
25	Condenser assembly	1	201521890066
26	Display box assembly	1	2033218A0118
26.1	Control panel	1	201121890030
26.2	Display board assembly	1	201321990020
	Display panel artwork	1	2020218A0766
27	Cover of electronic control box	1	201221890058
28	Electronic control box assembly	1	203321890104
28.1	Transformer	1	202300900140
28.2	Capacitor of fan motor	1	202401100505
28.3	Electronic control box	1	201221890057
28.4	Main control board assembly	1	201321390058
28.5	Bracket of main control board	1	201121890090
28.6	Capacitor of compressor	1	202401000508
28.7	Capacitor clip	1	201225590048
28.8	Power cord	1	202402260127
29	Remote controller	1	2033550A3128

Design, material, performance data and components
subject to change without notice.

HEAT CONTROLLER, INC.

1900 Wellworth Ave., Jackson, MI 49203 ♦ Ph. 517-787-2100 ♦ Fax 517-787-9341

THE QUALITY LEADER IN CONDITIONING AIR

www.heatcontroller.com