

This Owner's Manual is provided and hosted by [Appliance Factory Parts](http://ApplianceFactoryParts.com).

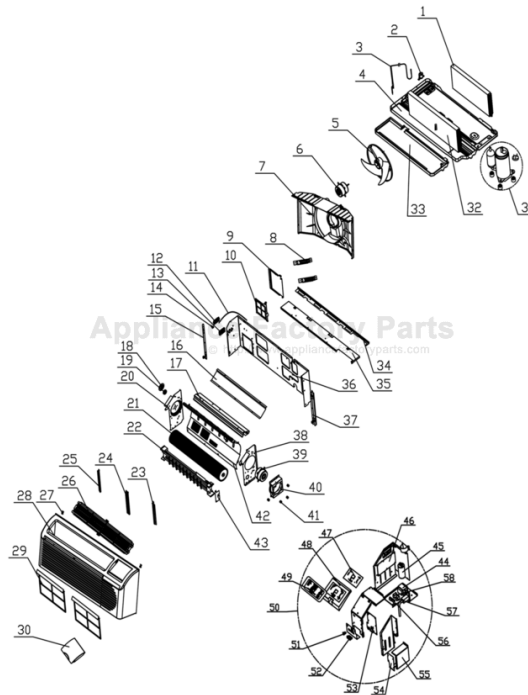

COMFORT-AIRE EKTC12-1G Owner's Manual

[Shop genuine replacement parts for COMFORT-AIRE
EKTC12-1G](#)



[Find Your COMFORT-AIRE HVAC Parts - Select From 1486 Models](#)

----- Manual continues below -----

Comfort-Aire®

Century®

MARS
Delivering Confidence

REPLACEMENT PARTS LIST

Packaged Terminal Air Conditioners & Heat Pumps

7,000-15,000 BTUH

Cooling with Electric Heat

EKTC07-1G

EKTC09-1G

EKTC12-1G

EKTC15-1G

Heat Pump with Electric Heat

EKTH07-1G

EKTH09-1G

EKTH12-1G

EKTH15-1G

Exploded View

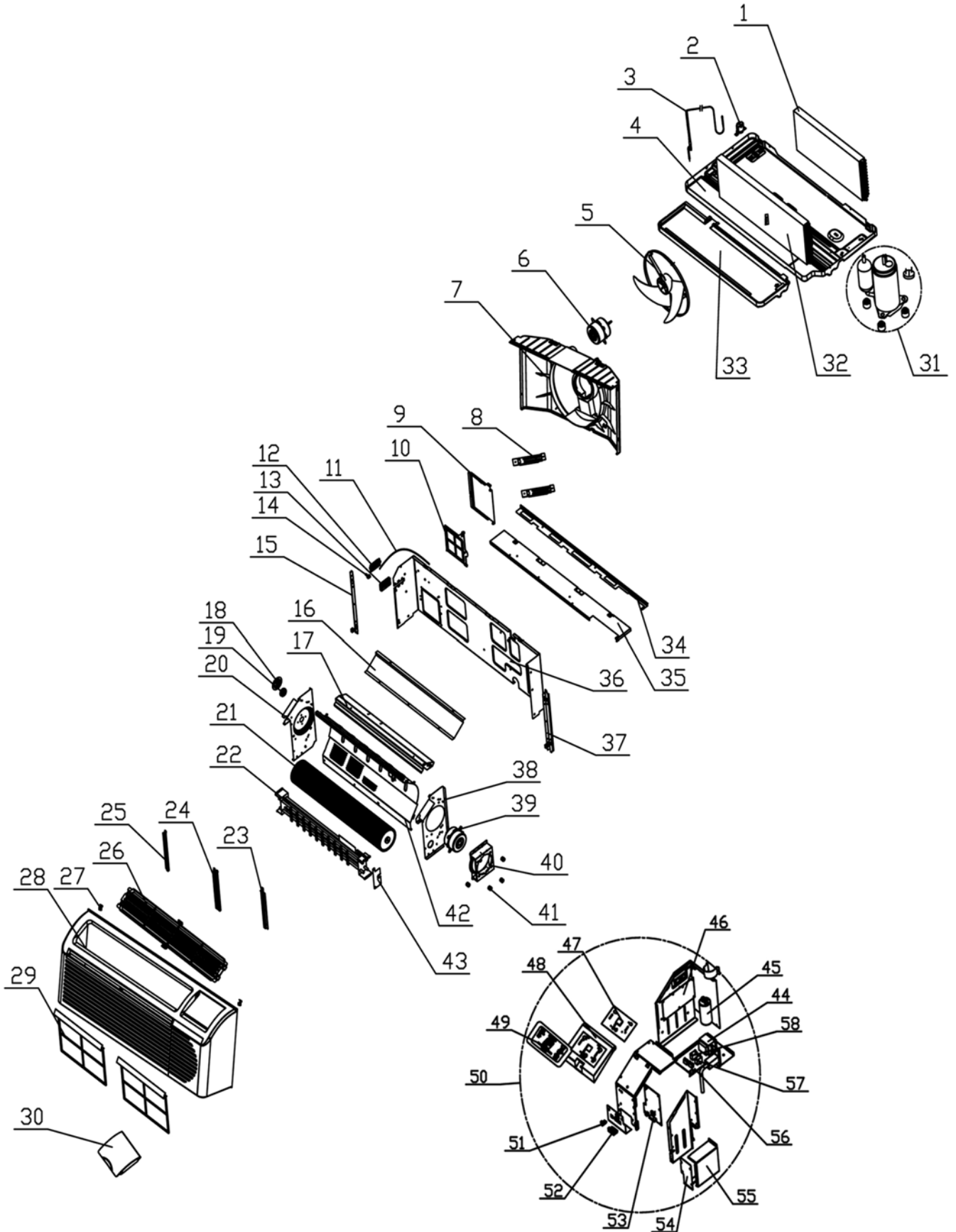

EKTC07-1G Parts List

Location	Description	Part No.	Qty.
1	Condenser Assy	01101272	1
2	Drainage Valve	07100164	1
3	Capillary Sub-Assy	03001424	1
4	Chassis Sub-assy	0120102601P	1
5	Axial Flow Fan	10331004	1
6	Fan Motor	150110343	1
7	Diversion Circle	10371004	1
8	Mid-connect board	01381004	2
9	Air inlet door Sub-assy	01441008	1
10	Filter Sub-Assy	11121213	1
11	Door thread	02121014	1
12	Upper cover of hand lever	26231154	1
13	Lower cover of hand lever	26231155	1
14	Hand lever	26231153	1
15	Outer support sub-assy (left)	01701015	1
16	Rear grill	01471007	1
17	Helicoid tongue	02121010P	1
18	Bearing board	02111010	1
19	Bearing Holder	26151138	1
20	Left side board of duct	02121008P	1
21	Cross Flow Fan	10351002	1
22	Electric Heater Tube	3200102602	1
23	Press board of filter 1	26111139	1
24	Press board of filter 2	26111140	1
25	Press board of filter 3	26111141	1
26	Air Outlet Grille	22411153	1
27	Front panel mtg. clips	02111013	2
28	Front Panel	20001457	1
29	Filter	11121212	2
30	Remote Control Cover	20121070	1
31	Compressor and fittings	00101061	1
32	Evaporator Assy	01001066	1
33	Thermal baffle	02121012	1
34	Up plate bracket	01701009	1
35	Top Cover Plate Sub-Assy	01251013	1
36	Mid-Clapboard	01231041P	1
37	Outer support sub-assy (right)	01701016	1
38	Right side board of duct	02121009P	1
39	Fan Motor	1501180202	1
40	Motor Support Sub-Assy	01701014P	1
41	Damping rubber	76711031	4
42	Air duct sub-assy	01221012	1
43	Heater Wiring block board	02111009	1
44	Transformer	43110270	1
45	Capacitor CBB65 15/450V (compressor)	33010045	1
46	Main board 1	30032021	1
47	Display Board	30542007	1
48	LCD Cover	20161239	1
49	Control panel glue gasket	76711007	1
50	Electric Box Assy	01401254	1
51	Wiring terminal	42010037	1
52	Wiring terminal	42010039S	1
53	Main board 2	30032022	1
54	Junction lid	01251015	1
55	Junction box	01411050	1
56	Terminal Board	42011103	2
57	Capacitor CBB61 1/500V (indoor fan)	33010089	1
58	Capacitor CBB61 2/450V (outdoor fan)	33010025	1
-	Temperature Sensor	390002072	1
-	Pipe Sensor	390001921	1
-	Ambient	390002123	1
Not Shown	Indoor Foam Drain Pan	12411904	1

EKTC09-1G Parts List

Location	Description	Part No.	Qty.
1	Condenser Assy	01101809	1
2	Drainage Valve	07100164	1
3	Capillary Sub-Assy	03001119	1
4	Chassis Sub-assy	0120102603P	1
5	Axial Flow Fan	10331004	1
6	Fan Motor	150110343	1
7	Diversion Circle	10371004	1
8	Mid-connect board	01381004	2
9	Air inlet door Sub-assy	01441008	1
10	Filter Sub-Assy	11121213	1
11	Door thread	02121014	1
12	Upper cover of hand lever	26231154	1
13	Lower cover of hand lever	26231155	1
14	Hand lever	26231153	1
15	Outer support sub-assy (left)	01701015	1
16	Rear grille	01471007	1
17	Helicoid tongue	02121010P	1
18	Bearing board	02111010	1
19	Bearing Holder	26151138	1
20	Left side board of duct	02121008P	1
21	Cross Flow Fan	10351002	1
22	Electric Heater Tube	3200102602	1
23	Press board of filter 1	26111139	1
24	Press board of filter 2	26111140	1
25	Press board of filter 3	26111141	1
26	Air Outlet Grille	22411153	1
27	Front panel mtg. clips	02111013	2
28	Front Panel	20001457	1
29	Filter	11121212	2
30	Remote Control Cover	20121070	1
31	Compressor and fittings	00101049	1
32	Evaporator Assy	01001060	1
33	Thermal baffle	02121012	1
34	Up plate bracket	01701009	1
35	Top Cover Plate Sub-Assy	01251013	1
36	Mid-Clapboard	01231041P	1
37	Outer support sub-assy (right)	01701016	1
38	Right side board of duct	02121009P	1
39	Fan Motor	15011802	1
40	Motor Support Sub-Assy	01701014P	1
41	Damping rubber	76711031	4
42	Air duct sub-assy	01221011	1
43	Heater Wiring block board	02111009	1
44	Transformer	43110270	1
45	Capacitor CBB65 25/450V (compressor)	33000017	1
46	Main board 1	30032021	1
47	Display Board	30542007	1
48	LCD Cover	20161239	1
49	Control panel glue gasket	76711007	1
50	Electric Box Assy	01401426	1
51	Wiring terminal	42010037	1
52	Wiring terminal	42010039S	1
53	Main board 2	30032022	1
54	Junction lid	01251015	1
55	Junction box	01411050	1
56	Terminal Board	42011103	2
57	Capacitor CBB61 1.5 UF 450V (indoor fan)	33010020	1
58	Capacitor CBB61 (outdoor fan)	33010025	1
-	Temperature Sensor	390002072	1
-	Pipe Sensor	390001921	1
-	Ambient	390002123	1
Not Shown	Indoor Foam Drain Pan	12411904	1

EKTC12-1G Parts List

Location	Description	Part No.	Qty.
1	Condenser Assy	01101809	1
2	Drainage Valve	07100164	1
3	Capillary Sub-Assy	03001139	1
4	Chassis Sub-assy	0120102604P	1
5	Axial Flow Fan	10331004	1
6	Fan Motor	15011047	1
7	Diversion Circle	10371004	1
8	Mid-connect board	01381004	2
9	Air inlet door Sub-assy	01441008	1
10	Filter Sub-Assy	11121213	1
11	Door thread	02121014	1
12	Upper cover of hand lever	26231154	1
13	Lower cover of hand lever	26231155	1
14	Hand lever	26231153	1
15	Outer support sub-assy (left)	01701015	1
16	Rear grill	01471007	1
17	Helicoid tongue	02121010P	1
18	Bearing board	02111010	1
19	Bearing Holder	26151138	1
20	Left side board of duct	02121008P	1
21	Cross Flow Fan	10351002	1
22	Electric Heater Tube	32001026	1
23	Press board of filter 1	26111139	1
24	Press board of filter 2	26111140	1
25	Press board of filter 3	26111141	1
26	Air Outlet Grille	22411153	1
27	Front panel mtg. clips	02111013	2
28	Front Panel	20001457	1
29	Filter	11121212	2
30	Remote Control Cover	20121070	1
31	Compressor and fittings	00101053	1
32	Evaporator Assy	01001285	1
33	Thermal baffle	02121012	1
34	Up plate bracket	01701009	1
35	Top Cover Plate Sub-Assy	01251013	1
36	Mid-Clapboard	01231041P	1
37	Outer support sub-assy (right)	01701016	1
38	Right side board of duct	02121009P	1
39	Fan Motor	1501180203	1
40	Motor Support Sub-Assy	01701014P	1
41	Damping rubber	76711031	4
42	Air duct sub-assy	0144100904	1
43	Heater Wiring block board	02111009	1
44	Transformer	43110270	1
45	Capacitor CBB65 (compressor)	33000017	1
46	Main board 1	30032021	1
47	Display Board	30542007	1
48	LCD Cover	20161239	1
49	Control panel glue gasket	76711007	1
50	Electric Box Assy	01401428	1
51	Wiring terminal	42010037	1
52	Wiring terminal	42010039S	1
53	Main board 2	30032022	1
54	Junction lid	01251015	1
55	Junction box	01411050	1
56	Terminal Board	42011103	2
57	Capacitor CBB61 (indoor fan)	33010089	1
58	Capacitor CBB61 (outdoor fan)	33010026	1
-	Temperature Sensor	390002072	1
-	Pipe Sensor	390001921	1
-	Ambient	390002123	1
Not Shown	Indoor Foam Drain Pan	12411904	1

EKTH12-1G Parts List

Location	Description	Part No.	Qty.
1	Condenser Assy	01101809	1
2	Drainage Valve	07100164	1
3	Capillary Sub-Assy	03001139	1
4	Chassis Sub-assy	0120102604P	1
5	Axial Flow Fan	10331004	1
6	Fan Motor	15011047	1
7	Diversion Circle	10371004	1
8	Mid-connect board	01381004	2
9	Air inlet door Sub-assy	01441008	1
10	Filter Sub-Assy	11121213	1
11	Door thread	02121014	1
12	Upper cover of hand lever	26231154	1
13	Lower cover of hand lever	26231155	1
14	Hand lever	26231153	1
15	Outer support sub-assy (left)	01701015	1
16	Rear grill	01471007	1
17	Helicoid tongue	02121010P	1
18	Bearing board	02111010	1
19	Bearing Holder	26151138	1
20	Left side board of duct	02121008P	1
21	Cross Flow Fan	10351002	1
22	Electric Heater Tube	32001026	1
23	Press board of filter 1	26111139	1
24	Press board of filter 2	26111140	1
25	Press board of filter 3	26111141	1
26	Air Outlet Grille	22411153	1
27	Front panel mtg. clips	02111013	2
28	Front Panel	20001457	1
29	Filter	11121212	2
30	Remote Control Cover	20121070	1
31	Compressor and fittings	00101053	1
32	Evaporator Assy	01001285	1
33	Thermal baffle	02121012	1
34	Up plate bracket	01701009	1
35	Top Cover Plate Sub-Assy	01251013	1
36	Mid-Clapboard	01231041P	1
37	Outer support sub-assy (right)	01701016	1
38	Right side board of duct	02121009P	1
39	Fan Motor	1501180203	1
40	Motor Support Sub-Assy	01701014P	1
41	Damping rubber	76711031	4
42	Air duct sub-assy	0144100904	1
43	Heater Wiring block board	02111009	1
44	Transformer	43110270	1
45	Capacitor CBB65 (compressor)	33000017	1
46	Main board 1	30032020	1
47	Display Board	30542007	1
48	LCD Cover	20161239	1
49	Control panel glue gasket	76711007	1
50	Electric Box Assy	01401430	1
51	Wiring terminal	42010037	1
52	Wiring terminal	42010039S	1
53	Main board 2	30032022	1
54	Junction lid	01251015	1
55	Junction box	01411050	1
56	Terminal Board	42011103	2
57	Capacitor CBB61 (indoor fan)	33010089	1
58	Capacitor CBB61 (outdoor fan)	33010026	1
-	Temperature Sensor	390002072	1
-	Pipe Sensor	390001921	1
-	Ambient	390002123	1
Not Shown	Indoor Foam Drain Pan	12411904	1

EKTC15-1G Parts List

Location	Description	Part No.	Qty.
1	Condenser Assy	01101191	1
2	Drainage Valve	07100164	1
3	Capillary Sub-Assy	03001341	1
4	Chassis Sub-assy	01201026P	1
5	Axial Flow Fan	10331004	1
6	Fan Motor	15011047	1
7	Diversion Circle	10371004	1
8	Mid-connect board	01381004	2
9	Air inlet door Sub-assy	01441008	1
10	Filter Sub-Assy	11121213	1
11	Door thread	02121014	1
12	Upper cover of hand lever	26231154	1
13	Lower cover of hand lever	26231155	1
14	Hand lever	26231153	1
15	Outer support sub-assy (left)	01701015	1
16	Rear grill	01471007	1
17	Helicoid tongue	02121010P	1
18	Bearing board	02111010	1
19	Bearing Holder	26151138	1
20	Left side board of duct	02121008P	1
21	Cross Flow Fan	10351002	1
22	Electric Heater Tube	32001026	1
23	Press board of filter 1	26111139	1
24	Press board of filter 2	26111140	1
25	Press board of filter 3	26111141	1
26	Air Outlet Grille	22411153	1
27	Front panel mtg. clips	02111013	2
28	Front Panel	20001457	1
29	Filter	11121212	2
30	Remote Control Cover	20121070	1
31	Compressor and fittings	00101085	1
32	Evaporator Assy	01001285	1
33	Thermal baffle	02121012	1
34	Up plate bracket	01701009	1
35	Top Cover Plate Sub-Assy	01251013	1
36	Mid-Clapboard	01231041P	1
37	Outer support sub-assy (right)	01701016	1
38	Right side board of duct	02121009P	1
39	Fan Motor	1501180203	1
40	Motor Support Sub-Assy	01701014P	1
41	Damping rubber	76711031	4
42	Air duct sub-assy	0144100904	1
43	Heater Wiring block board	02111009	1
44	Transformer	43110270	1
45	Capacitor CBB65 (compressor)	33000045	1
46	Main board 1	30032021	1
47	Display Board	30542007	1
48	LCD Cover	20161239	1
49	Control panel glue gasket	76711007	1
50	Electric Box Assy	01401873	1
51	Wiring terminal	42010037	1
52	Wiring terminal	42010039S	1
53	Main board 2	30032022	1
54	Junction lid	01251015	1
55	Junction box	01411050	1
56	Terminal Board	42011103	2
57	Capacitor CBB61 (indoor fan)	33010089	1
58	Capacitor CBB61 (outdoor fan)	33010026	1
-	Temperature Sensor	390002072	1
-	Pipe Sensor	390001921	1
-	Ambient	390002123	1
Not Shown	Indoor Foam Drain Pan	12411904	1

EKTH15-1G Parts List

Location	Description	Part No.	Qty.
1	Condenser Assy	01101191	1
2	Drainage Valve	07100164	1
3	Capillary Sub-Assy	03001434	1
4	Chassis Sub-assy	01201026P	1
5	Axial Flow Fan	10331004	1
6	Fan Motor	15011048	1
7	Diversion Circle	10371004	1
8	Mid-connect board	01381004	2
9	Air inlet door Sub-assy	01441008	1
10	Filter Sub-Assy	11121213	1
11	Door thread	02121014	1
12	Upper cover of hand lever	26231154	1
13	Lower cover of hand lever	26231155	1
14	Hand lever	26231153	1
15	Outer support sub-assy (left)	01701015	1
16	Rear grille	01471007	1
17	Helicoid tongue	02121010P	1
18	Bearing board	02111010	1
19	Bearing Holder	26151138	1
20	Left side board of duct	02121008P	1
21	Cross Flow Fan	10351002	1
22	Electric Heater Tube	32001026	1
23	Press board of filter 1	26111139	1
24	Press board of filter 2	26111140	1
25	Press board of filter 3	26111141	1
26	Air Outlet Grille	22411153	1
27	Front panel mtg. clips	02111013	2
28	Front Panel	20001457	1
29	Filter	11121212	2
30	Remote Control Cover	20121070	1
31	Compressor and fittings	00101085	1
32	Evaporator Assy	01001285	1
33	Thermal baffle	02121012	1
34	Up plate bracket	01701009	1
35	Top Cover Plate Sub-Assy	01251013	1
36	Mid-Clapboard	01231041P	1
37	Outer support sub-assy (right)	01701016	1
38	Right side board of duct	02121009P	1
39	Fan Motor	1501180203	1
40	Motor Support Sub-Assy	01701014P	1
41	Damping rubber	76711031	4
42	Air duct sub-assy	0144100904	1
43	Heater Wiring block board	02111009	1
44	Transformer	43110270	1
45	Capacitor CBB65 (compressor)	33000045	1
46	Main board 1	30032020	1
47	Display Board	30542007	1
48	LCD Cover	20161239	1
49	Control panel glue gasket	76711007	1
50	Electric Box Assy	01401899	1
51	Wiring terminal	42010037	1
52	Wiring terminal	42010039S	1
53	Main board 2	30032022	1
54	Junction lid	01251015	1
55	Junction box	01411050	1
56	Terminal Board	42011103	2
57	Capacitor CBB61 (indoor fan)	33010089	1
58	Capacitor CBB61 (outdoor fan)	33010026	1
-	Temperature Sensor	390002072	1
-	Pipe Sensor	390001921	1
-	Ambient	390002123	1
Not Shown	Indoor Foam Drain Pan	12411904	1

Exploded View

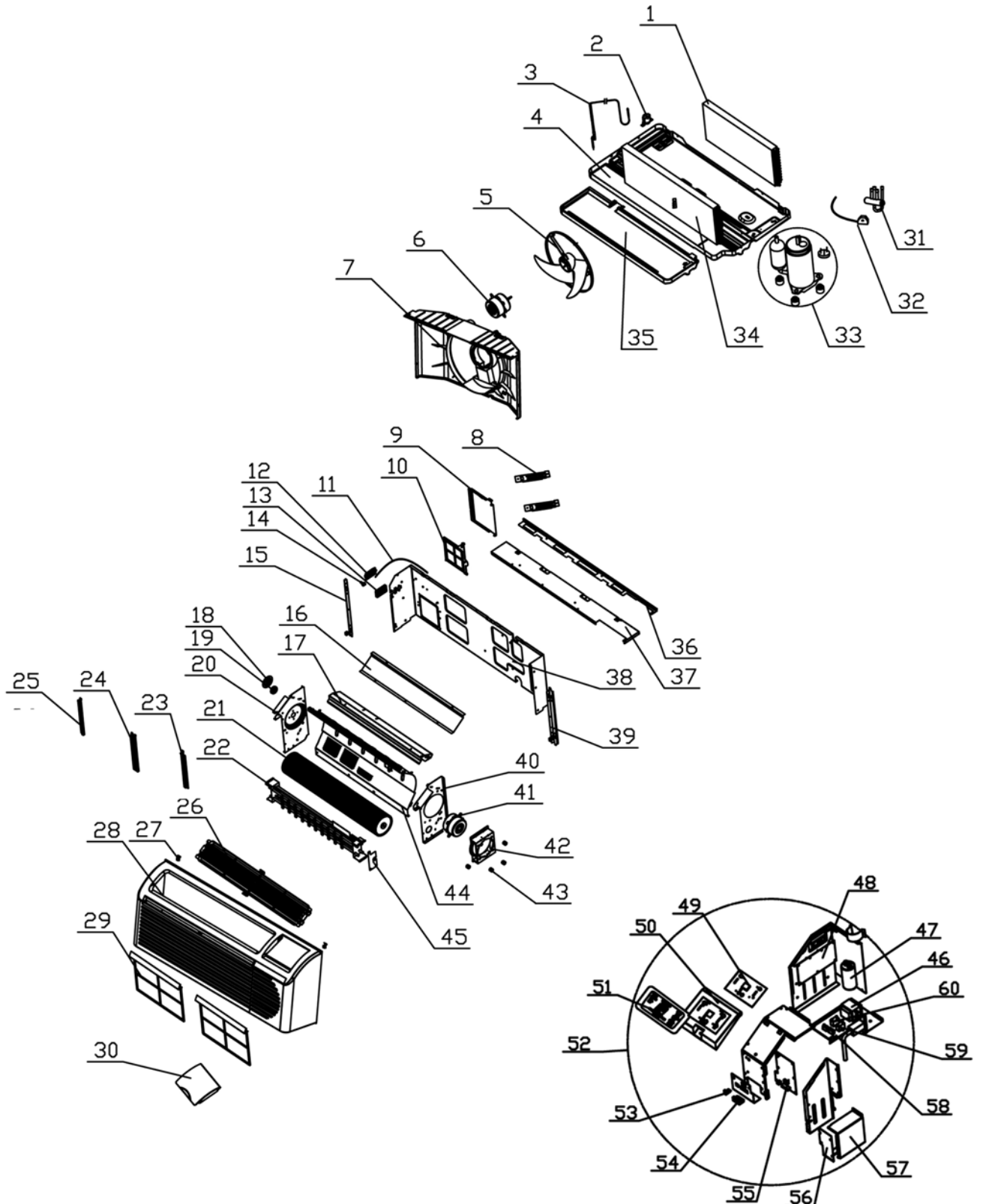

EKTH07-1G Parts List

Location	Description	Part No.	Qty.
1	Condenser Assy	01101272	1
2	Drainage Valve	07100164	1
3	Capillary Sub-Assy	03001424	1
4	Chassis Sub-assy	0120102601P	1
5	Axial Flow Fan	10331004	1
6	Fan Motor	150110343	1
7	Diversion Circle	10371004	1
8	Mid-connect board	01381004	2
9	Air inlet door Sub-assy	01441008	1
10	Filter Sub-Assy	11121213	1
11	Door thread	02121014	1
12	Upper cover of hand lever	26231154	1
13	Lower cover of hand lever	26231155	1
14	Hand lever	26231153	1
15	Outer support sub-assy (left)	01701015	1
16	Rear grille	01471007	1
17	Helicoid tongue	02121010P	1
18	Bearing board	02111010	1
19	Bearing Holder	26151138	1
20	Left side board of duct	02121008P	1
21	Cross Flow Fan	10351002	1
22	Electric Heater Tube	3200102602	1
23	Press board of filter 1	26111139	1
24	Press board of filter 2	26111140	1
25	Press board of filter 3	26111141	1
26	Air Outlet Grille	22411153	1
27	Front panel mtg. clips	02111013	2
28	Front Panel	20001457	1
29	Filter	11121212	2
30	Remote Control Cover	20121070	1
31	4-way Valve Sub-Assy	03021109	1
32	4-way Valve Fittings	4300040042	1
33	Compressor and fittings	00101061	1
34	Evaporator Assy	01001066	1
35	Thermal baffle	02121012	1
36	Up plate bracket	01701009	1
37	Top Cover Plate Sub-Assy	01251013	1
38	Mid-Clapboard	01231041P	1
39	Outer support sub-assy (right)	01701016	1
40	Right side board of duct	02121009P	1
41	Fan Motor	1501180202	1
42	Motor Support Sub-Assy	01701014P	1
43	Damping rubber	76711031	4
44	Air duct sub-assy	01221012	1
45	Heater Wiring block board	02111009	1
46	Transformer	43110270	1
47	Capacitor CBB65 (compressor)	33010045	1
48	Main board 1	30032020	1
49	Display Board	30542007	1
50	LCD Cover	20161239	1
51	Control panel glue gasket	76711007	1
52	Electric Box Assy	01401255	1
53	Wiring terminal	42010037	1
54	Wiring terminal	42010039S	1
55	Main board 2	30032022	1
56	Junction lid	01251015	1
57	Junction box	01411050	1
58	Terminal Board	42011103	2
59	Capacitor CBB61 (indoor fan)	33010089	1
60	Capacitor CBB61 (outdoor fan)	33010025	1
-	Temperature Sensor	390002072	1
-	Pipe Sensor	390001921	1
-	Ambient	390002123	1
Not Shown	Indoor Foam Drain Pan	12411904	1

EKTH09-1G Parts List

Location	Description	Part No.	Qty.
1	Condenser Assy	01101809	1
2	Drainage Valve	07100164	1
3	Capillary Sub-Assy	03001824	1
4	Chassis Sub-assy	0120102604P	1
5	Axial Flow Fan	10331004	1
6	Fan Motor	150110343	1
7	Diversion Circle	10371004	1
8	Mid-connect board	01381004	2
9	Air inlet door Sub-assy	01441008	1
10	Filter Sub-Assy	11121213	1
11	Door thread	02121014	1
12	Upper cover of hand lever	26231154	1
13	Lower cover of hand lever	26231155	1
14	Hand lever	26231153	1
15	Outer support sub-assy (left)	01701015	1
16	Rear grill	01471007	1
17	Helicoid tongue	02121010P	1
18	Bearing board	02111010	1
19	Bearing Holder	26151138	1
20	Left side board of duct	02121008P	1
21	Cross Flow Fan	10351002	1
22	Electric Heater Tube	3200102602	1
23	Press board of filter 1	26111139	1
24	Press board of filter 2	26111140	1
25	Press board of filter 3	26111141	1
26	Air Outlet Grille	22411153	1
27	Front panel mtg. clips	02111013	2
28	Front Panel	20001457	1
29	Filter	11121212	2
30	Remote Control Cover	20121070	1
31	4-way Valve Sub-Assy	03021505	1
32	4-way Valve Fittings	4300040042	1
33	Compressor and fittings	00101051	1
34	Evaporator Assy	01001284	1
35	Thermal baffle	02121012	1
36	Up plate bracket	01701009	1
37	Top Cover Plate Sub-Assy	01251013	1
38	Mid-Clapboard	01231041P	1
39	Outer support sub-assy (right)	01701016	1
40	Right side board of duct	02121009P	1
41	Fan Motor	15011802	1
42	Motor Support Sub-Assy	01701014P	1
43	Damping rubber	76711031	4
44	Air duct sub-assy	01221011	1
45	Heater Wiring block board	02111009	1
46	Transformer	43110270	1
47	Capacitor CBB65 (compressor)	33000017	1
48	Main board 1	30032020	1
49	Display Board	30542007	1
50	LCD Cover	20161239	1
51	Control panel glue gasket	76711007	1
52	Electric Box Assy	01401333	1
53	Wiring terminal	42010037	1
54	Wiring terminal	42010039S	1
55	Main board 2	30032022	1
56	Junction lid	01251015	1
57	Junction box	01411050	1
58	Terminal Board	42011103	2
59	Capacitor CBB61 (indoor fan)	33010020	1
60	Capacitor CBB61 (outdoor fan)	33010025	1
-	Temperature Sensor	390002072	1
-	Pipe Sensor	390001921	1
-	Ambient	390002123	1
Not Shown	Indoor Foam Drain Pan	12411904	1

Due to ongoing product improvements, specifications and dimensions are subject to change and correction without notice or incurring obligations. Determining the application and suitability for use of any product is the responsibility of the installer. Additionally, the installer is responsible for verifying dimensional data on the actual product prior to beginning any installation preparations.

Incentive and rebate programs have precise requirements as to product performance and certification. All products meet applicable regulations in effect on date of manufacture; however, certifications are not necessarily granted for the life of a product. Therefore, it is the responsibility of the applicant to determine whether a specific model qualifies for these incentive/rebate programs.

Comfort-Cire®  **Century**®

1900 Wellworth Ave., Jackson, MI 49203 • Ph. 517-787-2100 • www.marsdelivers.com

