

This Owner's Manual is provided and hosted by Appliance Factory Parts.

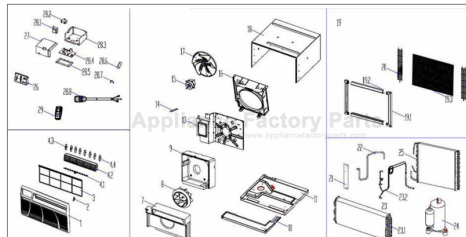

COMFORT-AIRE CGBG-81G Owner's Manual

[Shop genuine replacement parts for COMFORT-AIRE
CGBG-81G](#)



[Find Your COMFORT-AIRE HVAC Parts - Select From 1486 Models](#)

----- Manual continues below -----

HEAT CONTROLLER, INC.

REPLACEMENT PARTS LIST

Commercial Room Air Units CGBG-81G

EXPLODED VIEW

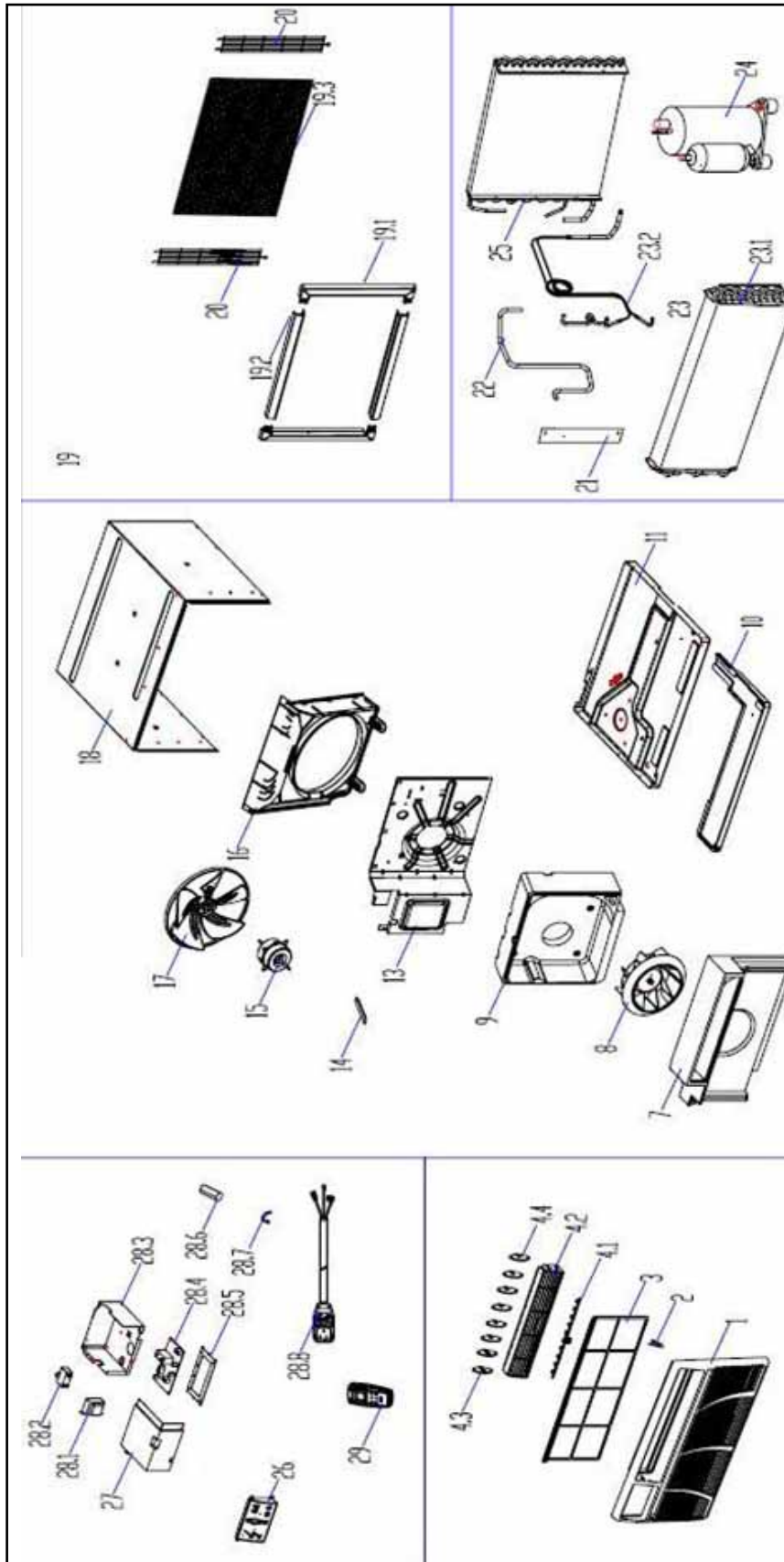

REPLACEMENT PARTS

Location	Part Name	Quantity	Part No.
1	Front panel	1	2011218A0177
2	Filter guide	2	201121890003
3	Air filter	1	2011218A0178
4	Air outlet assembly	1	2011218A0180
4.1	Connecting rod of louver	2	2011218A0183
4.2	Air outlet assembly	1	2011218A0184
4.3	Horizontal louver	2	2011218A0181
4.4	Horizontal louver	4	2011218A0182
7	Front volute shell	1	202221890013
8	Centrifugal fan	1	201100100028
9	Rear volute shell	1	202221390003
10	Condenser water tray	1	202221890010
11	Chassis assembly	1	2012218A0003
13	Front separating board	1	201221890033
14	Linker for front separating board	1	201221890034
15	Asynchronous motor	1	202400400951
16	Rear separating	1	201121390139
17	Axial flow fan	1	201100300022
18	Cabinet	1	2012213A0024
19	Installation accessory	1	2028215A0003
19.1	Left and right shutter frame	2	2011218A0175
19.2	Up and down shutter frame	2	2011218A0174
19.3	Plastic net	1	201121890009
20	Grille	1	201221890078
20	Grille	1	201221390106
21	Separating board for power cord	1	201121890017
22	Discharge pipe assembly	1	201621390288
23	Evaporator coil assembly	1	201521390076
23.1	Evaporator	1	201521590057
23.2	Capillary assembly	1	201621390198
24	Compressor	1	201400601110
25	Condenser assembly	1	201521590084
26	Display box assembly	1	2033218A0247
26.2	Display board assembly	1	2013218A0084
27	Cover of electronic control box	1	201221890058
28	Electronic control box assembly	1	203321390098
28.1	Transformer	1	202300900139
28.2	Capacitor of fan motor	1	202401100989
28.3	Electronic control box	1	201221890057
28.4	Main control board assembly	1	201321390058
28.5	Bracket of main control board	1	201121890090
28.6	Capacitor of compressor	1	202401090021
28.7	Capacitor clip	1	201225590048
28.8	Power cord	1	202402260126
29	Remote controller	1	2033550A6383

Design, material, performance data and components
subject to change without notice.

HEAT CONTROLLER, INC.

1900 Wellworth Ave., Jackson, MI 49203 • Ph. 517-787-2100 • Fax 517-787-9341

THE QUALITY LEADER IN CONDITIONING AIR

www.heatcontroller.com