

This Owner's Manual is provided and hosted by [Appliance Factory Parts](#).

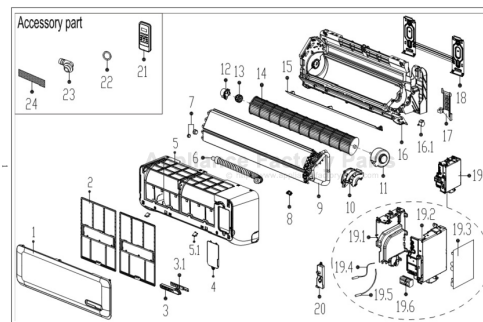

# COMFORT-AIRE B-DVC12SD-0 Owner's Manual

[Shop genuine replacement parts for COMFORT-AIRE  
B-DVC12SD-0](#)



[Find Your COMFORT-AIRE HVAC Parts - Select From 1486 Models](#)

----- Manual continues below -----

HEAT CONTROLLER

**REPLACEMENT  
PARTS LIST**

**Single Zone Inverter Mini-Splits**  
B-DVC12SD-0  
**Indoor Condenser**

# EXPLODED VIEW

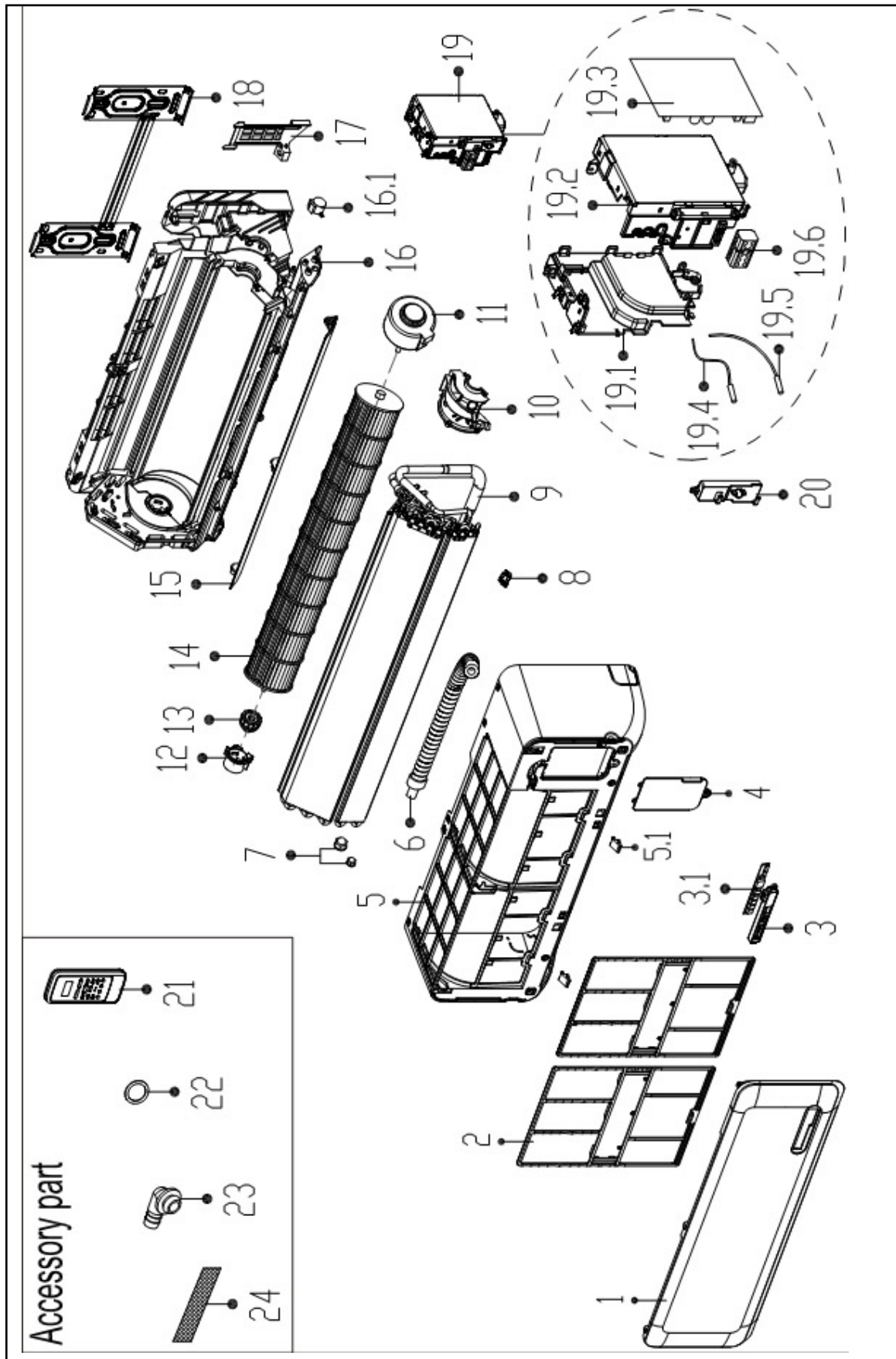

## REPLACEMENT PARTS

Location	Part Name	Quantity	Part No.
1	Panel assembly	1	2011324A0647
2	Air filter	2	201132490130
3	Display box assembly	1	2033325A2083
3.1	Display board assembly	1	2013323A1640
4	Cover of indoor electronic control box	1	201119900948
5	Panel frame assembly	1	201132490134
5.1	Screw cap	2	201119900950
6	Drain hose	1	201101020038
8	Fix clamp of temperature sensor	1	201102000305
9	Evaporator assembly	1	2015324A0071
10	Fan motor cover	1	201132490127
11	Asynchronous motor	1	202400300417
12	Bearing holder	1	201119900952
13	Bearing base	1	202719900606
14	Cross flow fan	1	201100200051
15	Horizontal louver	1	201132490131
16	Chassis assembly with drain pan	1	2011324A0232
16.1	Louver motor	1	202400200031
17	Pipe clamp board	1	201119900949
18	Installation plate	1	201232490004
19	Electronic control box assembly	1	203332591107
19.1	Electronic control box I	1	201132490125
19.2	Electronic control box II	1	201132490139
19.3	Main control board assembly	1	201332591029
19.4	Ambient temperature sensor assembly	1	202433190000
19.5	Pipe temperature sensor assembly	1	202301300584
19.6	Terminal strip	1	202301400488
20	Cover of electronic control box	1	201132490126
21	Remote Controller	1	2033550A8685
22	Seal	1	202720090001
23	Drain joint	1	201101020011
24	Air freshening filter	1	201130410455

Due to ongoing product improvements, specifications and dimensions are subject to change and correction without notice or incurring obligations. Determining the application and suitability for use of any product is the responsibility of the installer. Additionally, the installer is responsible for verifying dimensional data on the actual product prior to beginning any installation preparations.

Incentive and rebate programs have precise requirements as to product performance and certification. All products meet applicable regulations in effect on date of manufacture; however, certifications are not necessarily granted for the life of a product. Therefore, it is the responsibility of the applicant to determine whether a specific model qualifies for these incentive/rebate programs.

# HEAT CONTROLLER

1900 Wellworth Ave., Jackson MI 49203 • Ph. 517-787-2100 • [www.heatcontroller.com](http://www.heatcontroller.com)

A  Company