

This Owner's Manual is provided and hosted by [Appliance Factory Parts](#).



COMFORT-AIRE ADMH18SB17 Owner's Manual

[Shop genuine replacement parts for COMFORT-AIRE
ADMH18SB17](#)



[Find Your COMFORT-AIRE HVAC Parts - Select From 1486 Models](#)

----- Manual continues below -----

HEAT CONTROLLER, INC.

REPLACEMENT
PARTS

**DMC/DMH Series
Single Zone Ductless
Mini-Split Systems
A/C and Heat Pumps**

Exploded View

Indoor Unit



Outdoor Unit: 9k, 12k Btu/h Series

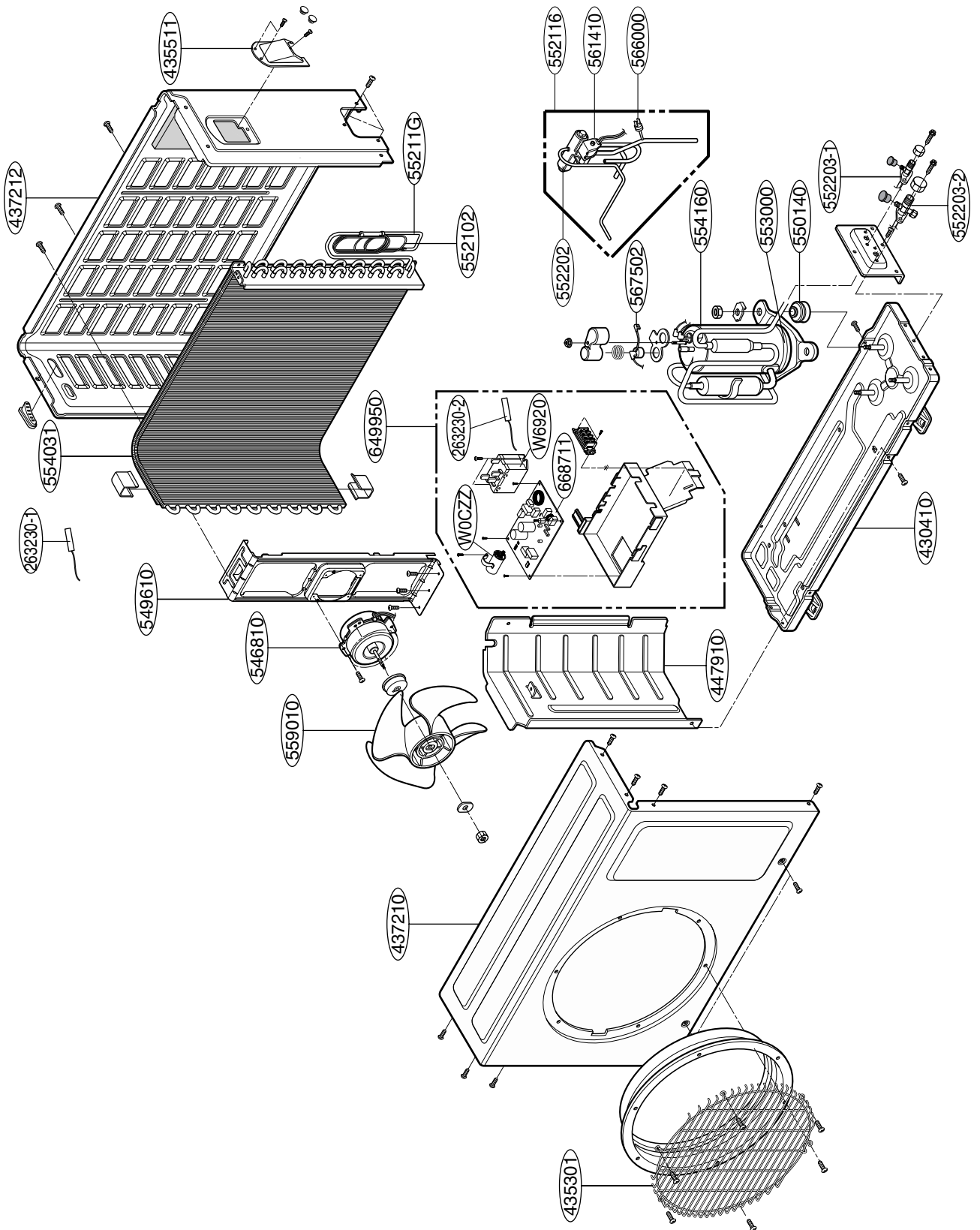

Outdoor Unit: 18k(C/O) Series

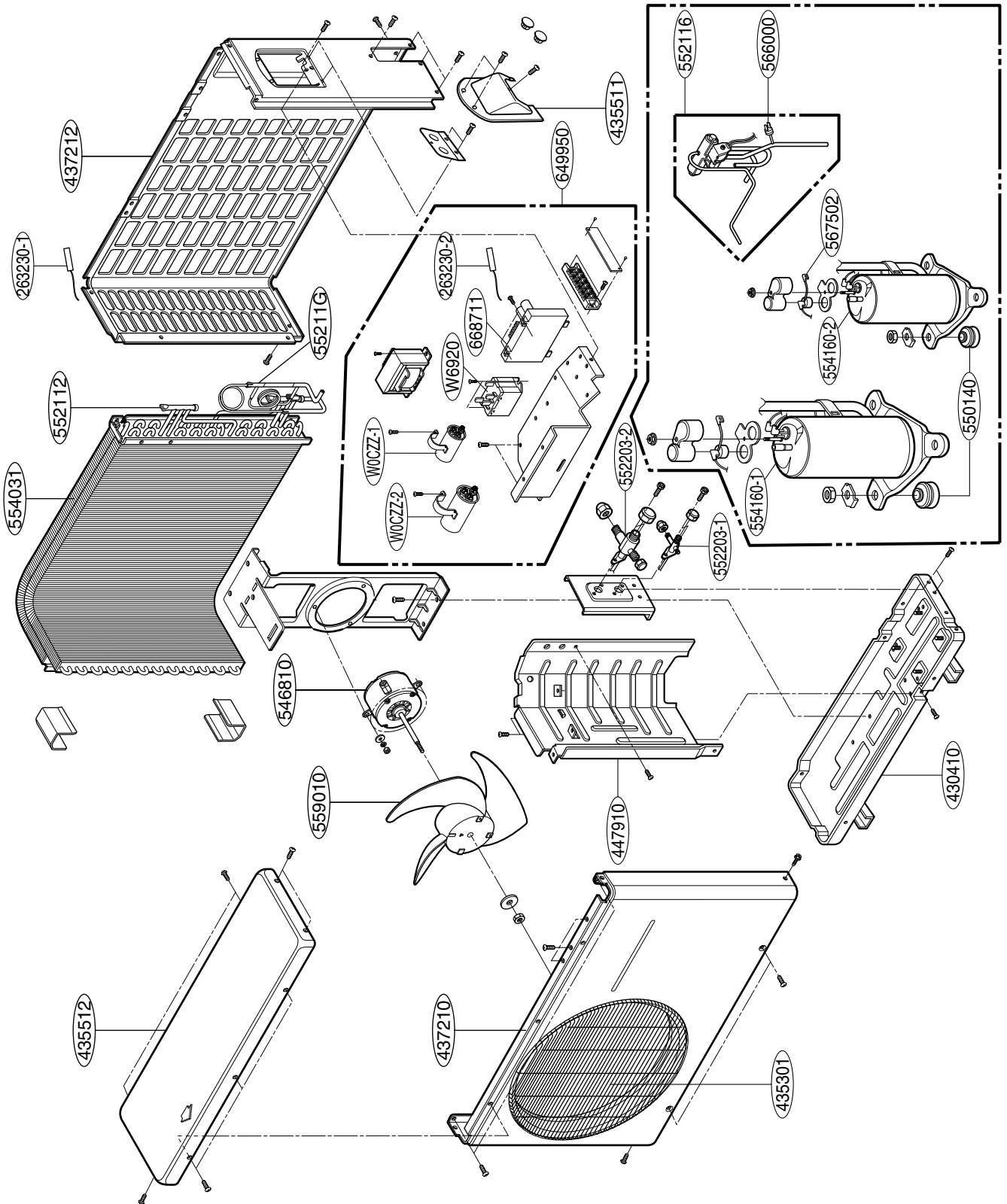

Outdoor Unit: 18k(H/P), 24k Series



Replacement Parts List

Parts List (Indoor)

| LOCATION No. | DESCRIPTION | PART No. | | | | REMARKS |
|--------------|------------------------------------|-------------|-------------|-------------|-------------|---------|
| | | B-DMC09SB-0 | B-DMC12SB-0 | B-DMH09SB-0 | B-DMH12SB-0 | |
| 131410 | CHASSIS ASSEMBLY | 3141A20019F | 3141A20034A | 3141A20034A | 3141A20034A | R |
| 135311 | GRILLE ASSEMBLY, DISCHARGE(INDOOR) | 3531A11307E | 3531A10362M | 3531A10362M | 3531A10362M | R |
| 135312 | GRILLE ASSEMBLY, FRONT(INDOOR) | 3531A14003N | AEB30571502 | AEB30571501 | AEB30571501 | R |
| 135516 | COVER ASSEMBLY, MOTOR | 3551A20156B | 3551A20156B | 3551A20156B | 3551A20156B | R |
| 146811 | MOTOR ASSEMBLY, STEP | 4681A20055A | 4681A20055A | 4681A20055A | 4681A20055A | R |
| 152302 | FILTER(MESH), A/C | 5230A20051B | 5230A20064A | 5230A20064A | 5230A20064A | R |
| 152312 | FILTER ASSEMBLY | 5231A20040A | 5231A20040K | 5231A20040K | 5231A20040K | R |
| 159901 | VANE, HORIZONTAL | 5990A20069A | 5990A20068A | 5990A20068A | 5990A20068A | R |
| 249951 | CONTROL BOX ASSEMBLY, INDOOR | 4995A10205C | 4995A10205D | 4995A10205D | 4995A10205D | R |
| 263230 | THERMISTOR ASSEMBLY | 6323A20004N | 6323A20004N | 6323A20004N | 6323A20004N | R |
| 267110 | REMOTE CONTROLLER ASSEMBLY | 6711A20128K | 6711A20128K | 6711A20128L | 6711A20128L | R |
| 268712 | PWC(PCB) ASSEMBLY, DISPLAY | 6871A20682A | 6871A20682A | 6871A20682A | 6871A20682A | R |
| 268714 | PWB(PCB) ASSEMBLY, MAIN | 6871A20771B | 6871A20771C | 6871A20771C | 6871A20771C | R |
| 342800 | BEARING | 4280A20004B | 4280A20004B | 4280A20004B | 4280A20004B | R |
| 346810 | MOTOR ASSEMBLY, INDOOR | 4681AR2295L | 4681AR2295L | 4681AR2295L | 4681AR2295L | R |
| 35211B | TUBE ASSEMBLY, TUBING | 5211A21363A | 5211A29044B | 5211A29044B | 5211A29044B | R |
| 354210 | EVAPORATOR ASSEMBLY, FIRST | 5421A20218A | 5421A20258B | 5421A20258B | 5421A20258B | R |
| 359011 | FAN ASSEMBLY, CROSS FLOW | 5901A20017F | 5901A20017H | 5901A20017H | 5901A20017H | R |
| 668713 | PWB(PCB) ASSEMBLY, SUB | 6871A20990B | 6871A20990F | 6871A20990C | 6871A20990C | R |
| 733010 | PLATE ASSLY INSTALLATION | 3301A20020A | 3301A20020A | 3301A20020A | 3301A20020A | R |

Replacement Parts List

Parts List (Indoor)

| LOCATION No. | DESCRIPTION | PART No. | | | | REMARKS |
|--------------|------------------------------------|-------------|--------------|-------------|-------------|---------|
| | | B-DMC18SB-1 | B-DMC-24SB-1 | B-DMH18SB-1 | B-DMH24SB-1 | |
| 131410 | CHASSIS ASSEMBLY | 3141A20020G | 3141A20020G | 3141A20020G | 3141A20020G | R |
| 135311 | GRILLE ASSEMBLY, DISCHARGE(INDOOR) | AEB30240204 | AEB30240204 | AEB30240204 | AEB30240204 | R |
| 135312 | GRILLE ASSEMBLY, FRONT(INDOOR) | 3531A20299K | 3531A20299K | 3531A20299J | 3531A20299J | R |
| 135516 | COVER ASSEMBLY, MOTOR | 3551A20154A | 3551A20154A | 3551A20154A | 3551A20154A | R |
| 146811 | MOTOR ASSEMBLY, STEP | 4681A20055A | 4681A20055A | 4681A20055A | 4681A20055A | R |
| 152302 | FILTER(MESH), A/C | 5230A20052B | 5230A20052B | 5230A20052B | 5230A20052B | R |
| 152312 | FILTER ASSEMBLY | 5231A20040B | 5231A20040B | 5231A20040B | 5231A20040B | R |
| 159901 | VANE, HORIZONTAL | 5990A20071A | 5990A20071A | 5990A20071A | 5990A20071A | R |
| 249951 | CONTROL BOX ASSEMBLY,INDOOR | 4995A10205B | 4995A10205E | 4995A10205E | 4995A10205E | R |
| 263230 | THERMISTOR ASSEMBLY | 6323A20004N | 6323A20004N | 6323A20004N | 6323A20004N | R |
| 276110 | REMOTE CONTROLLER ASSEMBLY | 6711A20128K | 6711A20128K | 6711A20128L | 6711A20128L | R |
| 268712 | PWC(PCB) ASSEMBLY, DISPLAY | 6871A20683A | 6871A20683A | 6871A20683A | 6871A20683A | R |
| 268714 | PWB(PCB) ASSEMBLY, MAIN | 6871A20771A | 6871A20771D | 6871A20771D | 6871A20771D | R |
| 342800 | BEARING | 4280A20004A | 4280A20004A | 4280A20004A | 4280A20004A | R |
| 346810 | MOTOR ASSEMBLY, INDOOR | 4681AR2295M | 4681AR2295M | 4681AR2295M | 4681AR2295M | R |
| 35211B | TUBE ASSEMBLY, TUBING | 5211A21378C | 5211A21378D | 5211A21378D | 5211A21378D | R |
| 354210 | EVAPORATOR ASSEMBLY, FIRST | 5421A20220A | 5421A20220A | 5421A20220A | 5421A20220A | R |
| 359011 | FAN ASSEMBLY, CROSS FLOW | 5901A92441E | 5901A92441E | 5901A92441E | 5901A92441E | R |
| 668713 | PWB(PCB) ASSEMBLY, SUB | 6871A20990G | 6871A20990E | 6871A20990D | 6871A20990D | R |
| 733010 | PLATE ASSLY INSTALLATION | 3301A20020B | 3301A20020B | 3301A20020B | 3301A20020B | R |

Parts List (Outdoor)

| LOCATION No. | DESCRIPTION | PART No. | | | | REMARKS |
|--------------|----------------------------------|-------------|-------------|-------------|-------------|---------|
| | | A-DMC09SB-0 | A-DMC12SB-0 | A-DMH09SB-0 | A-DMH12SB-0 | |
| 263230-1 | THERMISTOR ASSEMBLY | 6323A20002L | 6323A20002L | 6323A20002L | 6323A20002L | R |
| 263230-2 | THERMISTOR ASSEMBLY | 6323A20016A | 6323A20016A | 6323A20016A | 6323A20016A | R |
| 430410 | BASE, OUTDOOR | 3041A20008K | 3041A20008K | 3041A20008K | 3041A20008K | R |
| 435301 | GRILLE, DISCHARGE | 3530A20006G | 3530A20006G | 3530A20006G | 3530A20006G | R |
| 435511 | COVER ASSEMBLY, CONTROL(OUTDOOR) | 3551AR7184R | 3551AR7184R | 3551AR7184R | 3551AR7184R | R |
| 437210 | PANEL ASSEMBLY, FRONT(OUTDOOR) | 3721A20027Q | 3721A20027Q | 3721A20027Q | 3721A20027Q | R |
| 437212 | PANEL ASSEMBLY, REAR(OUTDOOR) | 3721A20026M | 3721A20026M | 3721A20026M | 3721A20026M | R |
| 447910 | BARRIER ASSEMBLY OUTDOOR | 4791A30002G | 4791A30002U | 4791A30002U | 4791A30002U | R |
| 55211G | TUBE ASSEMBLY, CONDENSER(OUT) | 5211A25032A | 5211A24118B | 5211A24118B | 5211A24118B | R |
| 552203-1 | VALVE, SERVICE | 5220A20005B | 5220A20005B | 5220A20005B | 5220A20005B | R |
| 552203-2 | VALVE, SERVICE | 5220A20001Q | 5220A20006A | 5220A20006A | 5220A20006A | R |
| 546810 | MOTOR ASSEMBLY, OUTDOOR | 4681A20122B | 4681A20122B | 4681A20122B | 4681A20122B | R |
| 549610 | BRACKET ASSEMBLY, MOTOR(OUTDOOR) | 4960A10011B | 4961A10015B | 4961A10015B | 4961A10015B | R |
| 550140 | ISOLATOR, COMP | 4H00982E | 4H00982E | 4H00982E | 4H00982E | R |
| 552116 | TUBE ASSEMBLY, REVERSE | - | 5211A26008A | 5211A26008A | 5211A26008A | R |
| 552202 | VALVE, REVERSE | - | 5220AR3228D | 5220AR3228D | 5220AR3228D | R |
| 553000 | HEATER, SUMP | - | 5300AR2915D | 5300AR2915D | 5300AR2915D | R |
| 554031 | CONDENSER ASSLY | 5403A20120B | 5403A20120C | 5403A20120C | 5403A20120C | R |
| 554160 | COMPRESSOR SET | 2520UGDC2AA | 2520UGAC2AA | 2520UGAC2AA | 2520UGAC2AA | R |
| 559010 | FAN ASSY, PROPELLER | 5901A10033A | 5901A10033A | 5901A10033A | 5901A10033A | R |
| 561410 | SOLENOID | - | - | 6141A90007C | 6141A90007C | R |
| 566000 | SWITCH, PRESSURE | 6600L000013 | 6600L000013 | 6600L000013 | 6600L000013 | R |
| 567502 | O.L.P. | 6750U-L031A | 6750U-L029A | 6750U-L029A | 6750U-L029A | R |
| 649950 | CONTROL BOX ASSY, OUTDOOR | 4995A21006P | 4995A21006Q | 4995A21006Q | 4995A21006Q | R |
| 668711 | PWB(PCB) ASSEMBLY, MAIN(OUTDOOR) | 6871A20901A | 6871A20901B | 6871A20901B | 6871A20901B | R |
| W0CZZ | CAPACITOR, DRAWING | 0CZZA10001A | 6120AR2359U | 6120AR2359U | 6120AR2359U | R |
| W6920 | RELAY, CONTACT | 6920AP3400F | 6920AP3400F | 6920AP3400F | 6920AP3400F | R |

Parts List (Outdoor)

| LOCATION No. | DESCRIPTION | PART No. | REMARKS |
|--------------|---------------------------------|-------------|---------|
| | | A-DMC18SB-1 | |
| 263230-1 | THERMISTOR ASSEMBLY | 6323A20002L | R |
| 263230-2 | THERMISTOR ASSEMBLY | 6323A20016A | R |
| 430410 | BASE ASSEMBLY,OUTDOOR | 3041AP2741G | R |
| 435301 | GRILLE,DISCHARGE | 3530A20007B | R |
| 435511 | COVER ASSEMBLY,CONTROL(OUTDOOR) | 3551AR7184T | R |
| 435512 | COVER ASSEMBLY,TOP(OUTDOOR) | 3H03266P | R |
| 437210 | PANEL ASSEMBLY,FRONT(SUB) | 3721A20005H | R |
| 437212 | PANEL ASSEMBLY,REAR(OUTDOOR) | 3720AP0003D | R |
| 447910 | BARRIER ASSEMBLY,OUTDOOR | 4791A30004K | R |
| 55211G | TUBE ASSEMBLY,CONDENSER(OUT) | 5211A25034A | R |
| 552203-1 | VALVE,SERVICE | 2H02479B | R |
| 552203-2 | VALVE,SERVICE | 5220A20006A | R |
| 554160-1 | COMPRESSOR SET,KOREA | 2520UGJK2AA | R |
| 554160-2 | COMPRESSOR SET,KOREA | 2520UGAK2AA | R |
| 546810 | MOTOR,UNCLASSIFIED | 4681A20013N | R |
| 549610 | BRACKET ASSEMBLY,MOTOR(OUTDOOR) | 4960AP1361A | R |
| 550140 | DAMPER,COMPRESSOR | 4H00982E | R |
| 552112 | TUBE ASSEMBLY,CONDENSER(IN) | 5211A25033A | R |
| 554031 | CONDENSER ASSEMBLY,BENDING | 5403A20058B | R |
| 566000 | SWITCH, PRESSURE | 6600L000013 | R |
| 567502-1 | OVERLOAD PROTECT | 6750U-L039A | R |
| 567502-2 | OVERLOAD PROTECT | 6750U-L058A | R |
| 559010 | FAN ASSEMBLY,PROPELLER | 1A00195B | R |
| 649950 | CASE ASSEMBLY,CONTROL(OUTDOOR) | 4995A20383M | R |
| 668711 | PWB(PCB) ASSEMBLY,MAIN(OUTDOOR) | 6871A10184C | R |
| W0CZZ-1 | CAPACITOR,DRAWING | 3A00988B | R |
| W0CZZ-2 | CAPACITOR,DRAWING | 6120AR2194D | R |
| W6920 | RELAY, CONTACT | 6920AP3400A | R |

Parts List (Outdoor)

| LOCATION No. | DESCRIPTION | PART No. | | | REMARKS |
|--------------|---------------------------------|-------------|-------------|-------------|---------|
| | | A-DMC24SB-1 | A-DMH18SB-1 | A-DMH24SB-1 | |
| 137213-1 | PANEL ASSEMBLY,SIDE | 1A00202F | 1A00202F | 1A00202F | R |
| 137213-2 | PANEL ASSEMBLY,SIDE | 3A02284N | 3A02284N | 3A02284N | R |
| 263230-1 | THERMISTOR ASSEMBLY | 6323A20002L | 6323A20002L | 6323A20002L | R |
| 263230-2 | THERMISTOR ASSEMBLY | 6323A20016A | 6323A20016A | 6323A20016A | R |
| 430410 | BASE ASSEMBLY,OUTDOOR | 3041AP2741G | 3041AP2741G | 3041AP2741G | R |
| 435300 | GRILLE,REAR | 1A00208A | 1A00208A | 1A00208A | R |
| 435301 | GRILLE,DISCHARGE | 3530A20007J | 3530A20007J | 3530A20007J | R |
| 435511 | COVER ASSEMBLY,CONTROL(OUTDOOR) | 3551AR7184T | 3551AR7184T | 3551AR7184T | R |
| 435512 | COVER ASSEMBLY, TOP(OUTDOOR) | 3H03266H | 3H03266H | 3H03266H | R |
| 437210 | PANEL ASSEMBLY,FRONT(SUB) | 1A00197C | 1A00197C | 1A00197C | R |
| 447910 | BARRIER ASSEMBLY,OUTDOOR | 4791A30004H | 4791A30004H | 4791A30004H | R |
| 55211G | TUBE ASSEMBLY,CONDENSER(OUT) | 5211A34008B | 5211A34008C | 5211A34008B | R |
| 552203-1 | VALVE,SERVICE | 2H02479B | 2H02479B | 2H02479B | R |
| 552203-2 | VALVE,SERVICE | 5220A20013C | 5220A20013C | 5220A20013C | R |
| 546810 | MOTOR,UNCLASSIFIED | 4681A20008E | 4681A20008E | 4681A20008E | R |
| 549610 | BRACKET ASSEMBLY,MOTOR(OUTDOOR) | 2A01035T | 2A01035T | 2A01035T | R |
| 550140 | DAMPER,COMPRESSOR | 4H00982E | 4H00982E | 4H00982E | R |
| 552112 | TUBE ASSEMBLY,CONDENSER(IN) | 5211A34007A | 5211A34007A | 5211A34007A | R |
| 552202 | VALVE, REVERSE | 5220AR3228E | 5220AR3228E | 5220AR3228E | R |
| 552116 | TUBE ASSEMBLY,REVERSE | 5211A24108B | 5211A24108B | 5211A24108B | R |
| 554160-1 | COMPRESSOR SET,KOREA | 2520UGHK2AA | 2520UGHK2AA | 2520UGHK2AA | R |
| 554160-2 | COMPRESSOR SET,KOREA | 2520UGKK2AA | 2520UGKK2AA | 2520UGKK2AA | R |
| 554031 | CONDENSER ASSEMBLY,BENDING | 5403A20047A | 5403A20047A | 5403A20047A | R |
| 566000 | SWITCH, PRESSURE | 6600L000013 | 6600L000013 | 6600L000013 | R |
| 559010 | FAN ASSEMBLY,PROPELLER | 1A00195B | 1A00195B | 1A00195B | R |
| 567502-1 | OVERLOAD PROTECT | 6750U-L048A | 6750U-L048A | 6750U-L048A | R |
| 567502-2 | OVERLOAD PROTECT | 6750U-L035A | 6750U-L035A | 6750U-L035A | R |
| 561410 | SOLENOID | - | 6141AR3733R | 6141AR3733R | R |
| 649950 | CASE ASSEMBLY,CONTROL(OUTDOOR) | 4995A20383L | 4995A20383L | 4995A20383L | R |
| 668711 | PWB(PCB) ASSEMBLY,MAIN(OUTDOOR) | 6871A10184F | 6871A10184F | 6871A10184F | R |
| W0CZZ-1 | CAPACITOR,DRAWING | 6120AR2194F | 6120AR2194F | 6120AR2194F | R |
| W0CZZ-2 | CAPACITOR,DRAWING | 3A00988B | 3A00988B | 3A00988B | R |
| W6920 | RELAY, CONTACT | 6920AP3400A | 6920AP3400A | 6920AP3400A | R |

**Design, material, performance data and components
subject to change without notice.**

HEAT CONTROLLER, INC.

1900 Wellworth Ave., Jackson, Michigan 49203 • Ph. 517-787-2100 • Fax 517-787-9341

THE QUALITY LEADER IN AIR CONDITIONING

www.heatcontroller.com