

This Owner's Manual is provided and hosted by [Appliance Factory Parts](#).



COMFORT-AIRE ADMH18SB33 Owner's Manual

[Shop genuine replacement parts for COMFORT-AIRE
ADMH18SB33](#)



[Find Your COMFORT-AIRE HVAC Parts - Select From 1486 Models](#)

----- Manual continues below -----

HEAT CONTROLLER, INC.

REPLACEMENT
PARTS

**DMC/DMH Series
Single Zone Ductless
Mini-Split Systems
A/C and Heat Pumps**

Exploded View

Indoor Unit



Outdoor Unit: 9k, 12k Btu/h Series

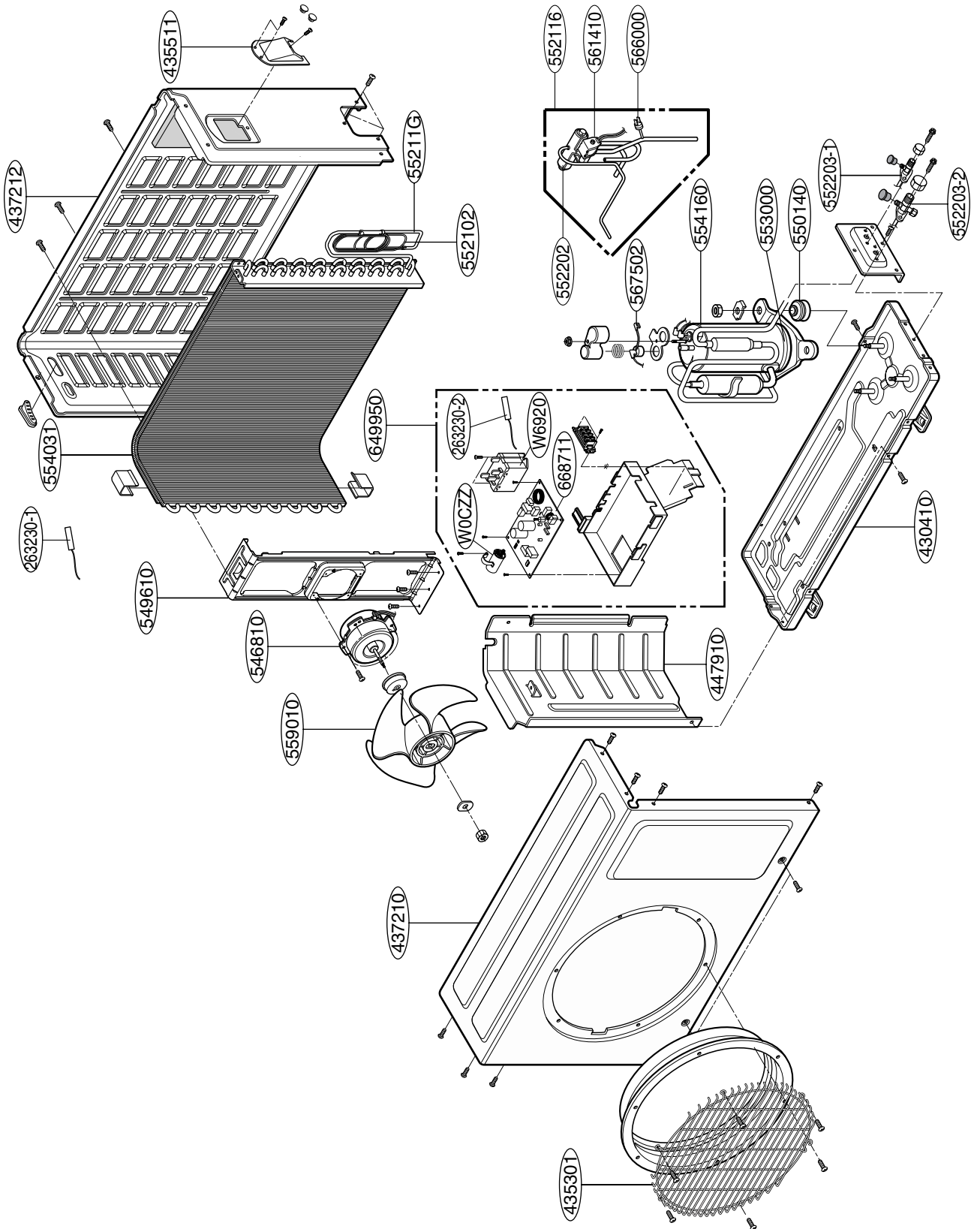

Outdoor Unit: 18k(H/P), 24k Series



Replacement Parts List

Parts List (Indoor)

LOCATION No.	DESCRIPTION	PART No.				REMARKS
		B-DMC09SB-0	B-DMC12SB-0	B-DMH09SB-0	B-DMH12SB-0	
131410	CHASSIS ASSEMBLY	3141A20019F	3141A20034A	3141A20034A	3141A20034A	R
135311	GRILLE ASSEMBLY, DISCHARGE(INDOOR)	3531A11307E	3531A10362M	3531A10362M	3531A10362M	R
135312	GRILLE ASSEMBLY, FRONT(INDOOR)	3531A14003N	AEB30571502	AEB30571501	AEB30571501	R
135516	COVER ASSEMBLY, MOTOR	3551A20156B	3551A20156B	3551A20156B	3551A20156B	R
146811	MOTOR ASSEMBLY, STEP	4681A20055A	4681A20055A	4681A20055A	4681A20055A	R
152302	FILTER(MESH), A/C	5230A20051B	5230A20064A	5230A20064A	5230A20064A	R
152312	FILTER ASSEMBLY	5231A20040A	5231A20040K	5231A20040K	5231A20040K	R
159901	VANE, HORIZONTAL	5990A20069A	5990A20068A	5990A20068A	5990A20068A	R
249951	CONTROL BOX ASSEMBLY, INDOOR	4995A10205C	4995A10205D	4995A10205D	4995A10205D	R
263230	THERMISTOR ASSEMBLY	6323A20004N	6323A20004N	6323A20004N	6323A20004N	R
267110	REMOTE CONTROLLER ASSEMBLY	6711A20128K	6711A20128K	6711A20128L	6711A20128L	R
268712	PWC(PCB) ASSEMBLY, DISPLAY	6871A20682A	6871A20682A	6871A20682A	6871A20682A	R
268714	PWB(PCB) ASSEMBLY, MAIN	6871A20771B	6871A20771C	6871A20771C	6871A20771C	R
342800	BEARING	4280A20004B	4280A20004B	4280A20004B	4280A20004B	R
346810	MOTOR ASSEMBLY, INDOOR	4681AR2295L	4681AR2295L	4681AR2295L	4681AR2295L	R
35211B	TUBE ASSEMBLY, TUBING	5211A21363A	5211A29044B	5211A29044B	5211A29044B	R
354210	EVAPORATOR ASSEMBLY, FIRST	5421A20218A	5421A20258B	5421A20258B	5421A20258B	R
359011	FAN ASSEMBLY, CROSS FLOW	5901A20017F	5901A20017H	5901A20017H	5901A20017H	R
668713	PWB(PCB) ASSEMBLY, SUB	6871A20990B	6871A20990F	6871A20990C	6871A20990C	R
733010	PLATE ASSLY INSTALLATION	3301A20020A	3301A20020A	3301A20020A	3301A20020A	R

Replacement Parts List

Parts List (Indoor)

LOCATION No.	DESCRIPTION	PART No.				REMARKS
		B-DMC18SB-1	B-DMC-24SB-1	B-DMH18SB-1	B-DMH24SB-1	
131410	CHASSIS ASSEMBLY	3141A20020G	3141A20020G	3141A20020G	3141A20020G	R
135311	GRILLE ASSEMBLY, DISCHARGE(INDOOR)	AEB30240204	AEB30240204	AEB30240204	AEB30240204	R
135312	GRILLE ASSEMBLY, FRONT(INDOOR)	3531A20299K	3531A20299K	3531A20299J	3531A20299J	R
135516	COVER ASSEMBLY, MOTOR	3551A20154A	3551A20154A	3551A20154A	3551A20154A	R
146811	MOTOR ASSEMBLY, STEP	4681A20055A	4681A20055A	4681A20055A	4681A20055A	R
152302	FILTER(MESH), A/C	5230A20052B	5230A20052B	5230A20052B	5230A20052B	R
152312	FILTER ASSEMBLY	5231A20040B	5231A20040B	5231A20040B	5231A20040B	R
159901	VANE, HORIZONTAL	5990A20071A	5990A20071A	5990A20071A	5990A20071A	R
249951	CONTROL BOX ASSEMBLY,INDOOR	4995A10205B	4995A10205E	4995A10205E	4995A10205E	R
263230	THERMISTOR ASSEMBLY	6323A20004N	6323A20004N	6323A20004N	6323A20004N	R
276110	REMOTE CONTROLLER ASSEMBLY	6711A20128K	6711A20128K	6711A20128L	6711A20128L	R
268712	PWC(PCB) ASSEMBLY, DISPLAY	6871A20683A	6871A20683A	6871A20683A	6871A20683A	R
268714	PWB(PCB) ASSEMBLY, MAIN	6871A20771A	6871A20771D	6871A20771D	6871A20771D	R
342800	BEARING	4280A20004A	4280A20004A	4280A20004A	4280A20004A	R
346810	MOTOR ASSEMBLY, INDOOR	4681AR2295M	4681AR2295M	4681AR2295M	4681AR2295M	R
35211B	TUBE ASSEMBLY, TUBING	5211A21378C	5211A21378D	5211A21378D	5211A21378D	R
354210	EVAPORATOR ASSEMBLY, FIRST	5421A20220A	5421A20220A	5421A20220A	5421A20220A	R
359011	FAN ASSEMBLY, CROSS FLOW	5901A92441E	5901A92441E	5901A92441E	5901A92441E	R
668713	PWB(PCB) ASSEMBLY, SUB	6871A20990G	6871A20990E	6871A20990D	6871A20990D	R
733010	PLATE ASSLY INSTALLATION	3301A20020B	3301A20020B	3301A20020B	3301A20020B	R

Parts List (Outdoor)

LOCATION No.	DESCRIPTION	PART No.				REMARKS
		A-DMC09SB-0	A-DMC12SB-0	A-DMH09SB-0	A-DMH12SB-0	
263230-1	THERMISTOR ASSEMBLY	6323A20002L	6323A20002L	6323A20002L	6323A20002L	R
263230-2	THERMISTOR ASSEMBLY	6323A20016A	6323A20016A	6323A20016A	6323A20016A	R
430410	BASE, OUTDOOR	3041A20008K	3041A20008K	3041A20008K	3041A20008K	R
435301	GRILLE, DISCHARGE	3530A20006G	3530A20006G	3530A20006G	3530A20006G	R
435511	COVER ASSEMBLY, CONTROL(OUTDOOR)	3551AR7184R	3551AR7184R	3551AR7184R	3551AR7184R	R
437210	PANEL ASSEMBLY, FRONT(OUTDOOR)	3721A20027Q	3721A20027Q	3721A20027Q	3721A20027Q	R
437212	PANEL ASSEMBLY, REAR(OUTDOOR)	3721A20026M	3721A20026M	3721A20026M	3721A20026M	R
447910	BARRIER ASSEMBLY OUTDOOR	4791A30002G	4791A30002U	4791A30002U	4791A30002U	R
55211G	TUBE ASSEMBLY, CONDENSER(OUT)	5211A25032A	5211A24118B	5211A24118B	5211A24118B	R
552203-1	VALVE, SERVICE	5220A20005B	5220A20005B	5220A20005B	5220A20005B	R
552203-2	VALVE, SERVICE	5220A20001Q	5220A20006A	5220A20006A	5220A20006A	R
546810	MOTOR ASSEMBLY, OUTDOOR	4681A20122B	4681A20122B	4681A20122B	4681A20122B	R
549610	BRACKET ASSEMBLY, MOTOR(OUTDOOR)	4960A10011B	4961A10015B	4961A10015B	4961A10015B	R
550140	ISOLATOR, COMP	4H00982E	4H00982E	4H00982E	4H00982E	R
552116	TUBE ASSEMBLY, REVERSE	-	5211A26008A	5211A26008A	5211A26008A	R
552202	VALVE, REVERSE	-	5220AR3228D	5220AR3228D	5220AR3228D	R
553000	HEATER, SUMP	-	5300AR2915D	5300AR2915D	5300AR2915D	R
554031	CONDENSER ASSLY	5403A20120B	5403A20120C	5403A20120C	5403A20120C	R
554160	COMPRESSOR SET	2520UGDC2AA	2520UGAC2AA	2520UGAC2AA	2520UGAC2AA	R
559010	FAN ASSY, PROPELLER	5901A10033A	5901A10033A	5901A10033A	5901A10033A	R
561410	SOLENOID	-	-	6141A90007C	6141A90007C	R
566000	SWITCH, PRESSURE	6600L000013	6600L000013	6600L000013	6600L000013	R
567502	O.L.P.	6750U-L031A	6750U-L029A	6750U-L029A	6750U-L029A	R
649950	CONTROL BOX ASSY, OUTDOOR	4995A21006P	4995A21006Q	4995A21006Q	4995A21006Q	R
668711	PWB(PCB) ASSEMBLY, MAIN(OUTDOOR)	6871A20901A	6871A20901B	6871A20901B	6871A20901B	R
W0CZZ	CAPACITOR, DRAWING	0CZZA10001A	6120AR2359U	6120AR2359U	6120AR2359U	R
W6920	RELAY, CONTACT	6920AP3400F	6920AP3400F	6920AP3400F	6920AP3400F	R

Parts List (Outdoor)

LOCATION No.	DESCRIPTION	PART No.	REMARKS
		A-DMC18SB-1	
263230-1	THERMISTOR ASSEMBLY	6323A20002L	R
263230-2	THERMISTOR ASSEMBLY	6323A20016A	R
430410	BASE ASSEMBLY,OUTDOOR	3041AP2741G	R
435301	GRILLE,DISCHARGE	3530A20007B	R
435511	COVER ASSEMBLY,CONTROL(OUTDOOR)	3551AR7184T	R
435512	COVER ASSEMBLY, TOP(OUTDOOR)	3H03266P	R
437210	PANEL ASSEMBLY,FRONT(SUB)	3721A20005H	R
437212	PANEL ASSEMBLY,REAR(OUTDOOR)	3720AP0003D	R
447910	BARRIER ASSEMBLY,OUTDOOR	4791A30004K	R
55211G	TUBE ASSEMBLY,CONDENSER(OUT)	5211A25034A	R
552203-1	VALVE,SERVICE	2H02479B	R
552203-2	VALVE,SERVICE	5220A20006A	R
554160-1	COMPRESSOR SET,KOREA	2520UGJK2AA	R
554160-2	COMPRESSOR SET,KOREA	2520UGAK2AA	R
546810	MOTOR,UNCLASSIFIED	4681A20013N	R
549610	BRACKET ASSEMBLY,MOTOR(OUTDOOR)	4960AP1361A	R
550140	DAMPER,COMPRESSOR	4H00982E	R
552112	TUBE ASSEMBLY,CONDENSER(IN)	5211A25033A	R
554031	CONDENSER ASSEMBLY,BENDING	5403A20058B	R
566000	SWITCH, PRESSURE	6600L000013	R
567502-1	OVERLOAD PROTECT	6750U-L039A	R
567502-2	OVERLOAD PROTECT	6750U-L058A	R
559010	FAN ASSEMBLY,PROPELLER	1A00195B	R
649950	CASE ASSEMBLY,CONTROL(OUTDOOR)	4995A20383M	R
668711	PWB(PCB) ASSEMBLY,MAIN(OUTDOOR)	6871A10184C	R
W0CZZ-1	CAPACITOR,DRAWING	3A00988B	R
W0CZZ-2	CAPACITOR,DRAWING	6120AR2194D	R
W6920	RELAY, CONTACT	6920AP3400A	R

Parts List (Outdoor)

LOCATION No.	DESCRIPTION	PART No.			REMARKS
		A-DMC24SB-1	A-DMH18SB-1	A-DMH24SB-1	
137213-1	PANEL ASSEMBLY,SIDE	1A00202F	1A00202F	1A00202F	R
137213-2	PANEL ASSEMBLY,SIDE	3A02284N	3A02284N	3A02284N	R
263230-1	THERMISTOR ASSEMBLY	6323A20002L	6323A20002L	6323A20002L	R
263230-2	THERMISTOR ASSEMBLY	6323A20016A	6323A20016A	6323A20016A	R
430410	BASE ASSEMBLY,OUTDOOR	3041AP2741G	3041AP2741G	3041AP2741G	R
435300	GRILLE,REAR	1A00208A	1A00208A	1A00208A	R
435301	GRILLE,DISCHARGE	3530A20007J	3530A20007J	3530A20007J	R
435511	COVER ASSEMBLY,CONTROL(OUTDOOR)	3551AR7184T	3551AR7184T	3551AR7184T	R
435512	COVER ASSEMBLY, TOP(OUTDOOR)	3H03266H	3H03266H	3H03266H	R
437210	PANEL ASSEMBLY,FRONT(SUB)	1A00197C	1A00197C	1A00197C	R
447910	BARRIER ASSEMBLY,OUTDOOR	4791A30004H	4791A30004H	4791A30004H	R
55211G	TUBE ASSEMBLY,CONDENSER(OUT)	5211A34008B	5211A34008C	5211A34008B	R
552203-1	VALVE,SERVICE	2H02479B	2H02479B	2H02479B	R
552203-2	VALVE,SERVICE	5220A20013C	5220A20013C	5220A20013C	R
546810	MOTOR,UNCLASSIFIED	4681A20008E	4681A20008E	4681A20008E	R
549610	BRACKET ASSEMBLY,MOTOR(OUTDOOR)	2A01035T	2A01035T	2A01035T	R
550140	DAMPER,COMPRESSOR	4H00982E	4H00982E	4H00982E	R
552112	TUBE ASSEMBLY,CONDENSER(IN)	5211A34007A	5211A34007A	5211A34007A	R
552202	VALVE, REVERSE	5220AR3228E	5220AR3228E	5220AR3228E	R
552116	TUBE ASSEMBLY,REVERSE	5211A24108B	5211A24108B	5211A24108B	R
554160-1	COMPRESSOR SET,KOREA	2520UGHK2AA	2520UGHK2AA	2520UGHK2AA	R
554160-2	COMPRESSOR SET,KOREA	2520UGKK2AA	2520UGKK2AA	2520UGKK2AA	R
554031	CONDENSER ASSEMBLY,BENDING	5403A20047A	5403A20047A	5403A20047A	R
566000	SWITCH, PRESSURE	6600L000013	6600L000013	6600L000013	R
559010	FAN ASSEMBLY,PROPELLER	1A00195B	1A00195B	1A00195B	R
567502-1	OVERLOAD PROTECT	6750U-L048A	6750U-L048A	6750U-L048A	R
567502-2	OVERLOAD PROTECT	6750U-L035A	6750U-L035A	6750U-L035A	R
561410	SOLENOID	-	6141AR3733R	6141AR3733R	R
649950	CASE ASSEMBLY,CONTROL(OUTDOOR)	4995A20383L	4995A20383L	4995A20383L	R
668711	PWB(PCB) ASSEMBLY,MAIN(OUTDOOR)	6871A10184F	6871A10184F	6871A10184F	R
W0CZZ-1	CAPACITOR,DRAWING	6120AR2194F	6120AR2194F	6120AR2194F	R
W0CZZ-2	CAPACITOR,DRAWING	3A00988B	3A00988B	3A00988B	R
W6920	RELAY, CONTACT	6920AP3400A	6920AP3400A	6920AP3400A	R

**Design, material, performance data and components
subject to change without notice.**

HEAT CONTROLLER, INC.

1900 Wellworth Ave., Jackson, Michigan 49203 • Ph. 517-787-2100 • Fax 517-787-9341

THE QUALITY LEADER IN AIR CONDITIONING

www.heatcontroller.com