

This Owner's Manual is provided and hosted by [Appliance Factory Parts](#).

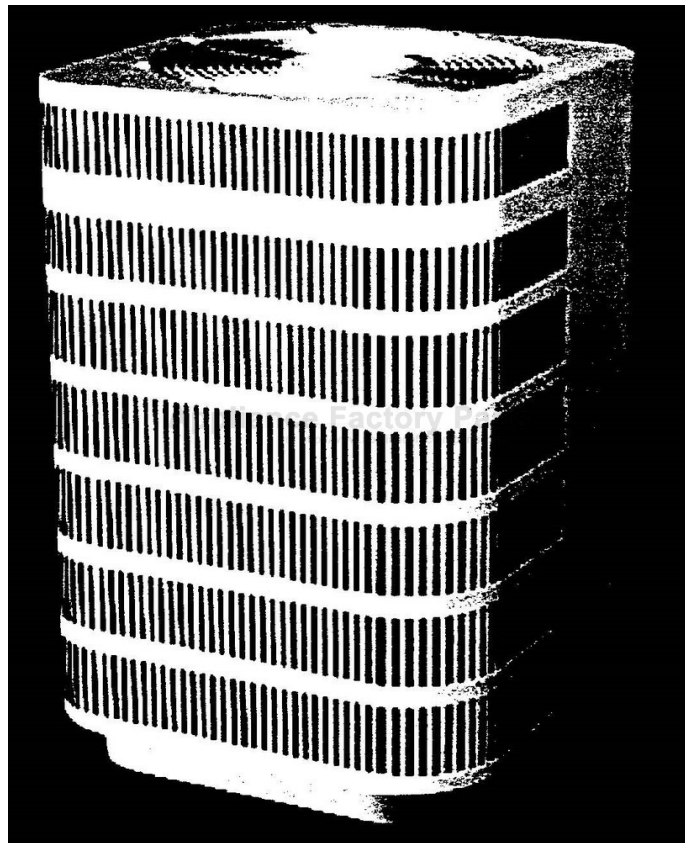

# COMFORT-AIRE RSC1218-1 Owner's Manual

[Shop genuine replacement parts for COMFORT-AIRE  
RSC1218-1](#)



[Find Your COMFORT-AIRE Air Conditioner Parts - Select From 599 Models](#)

----- Manual continues below -----

**The**  
**ENERGY**  **KNIGHT**®

# Split System High Efficiency Air Conditioning

RSC — 1.5 THRU 5 TON

## Replacement Parts Numbers Manual

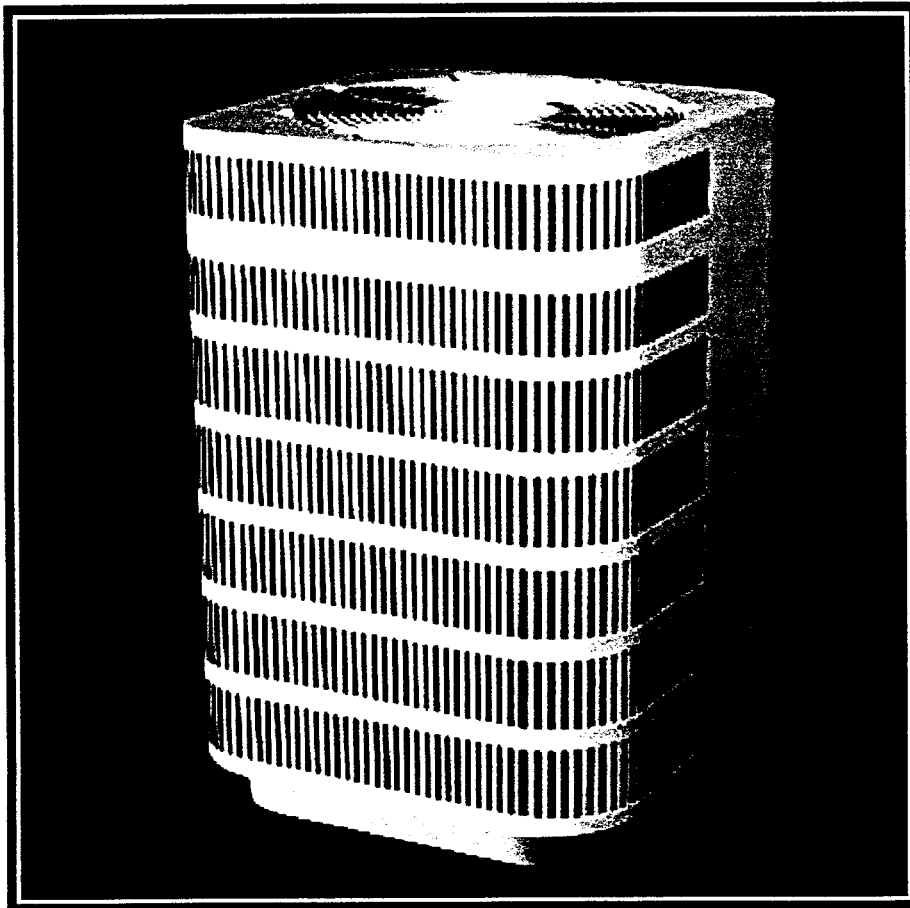

**HEAT CONTROLLER, INC.**

1900 WELLWORTH AVENUE • JACKSON, MICHIGAN 49203

*THE QUALITY LEADER IN CONDITIONING AIR*

HCI 03A

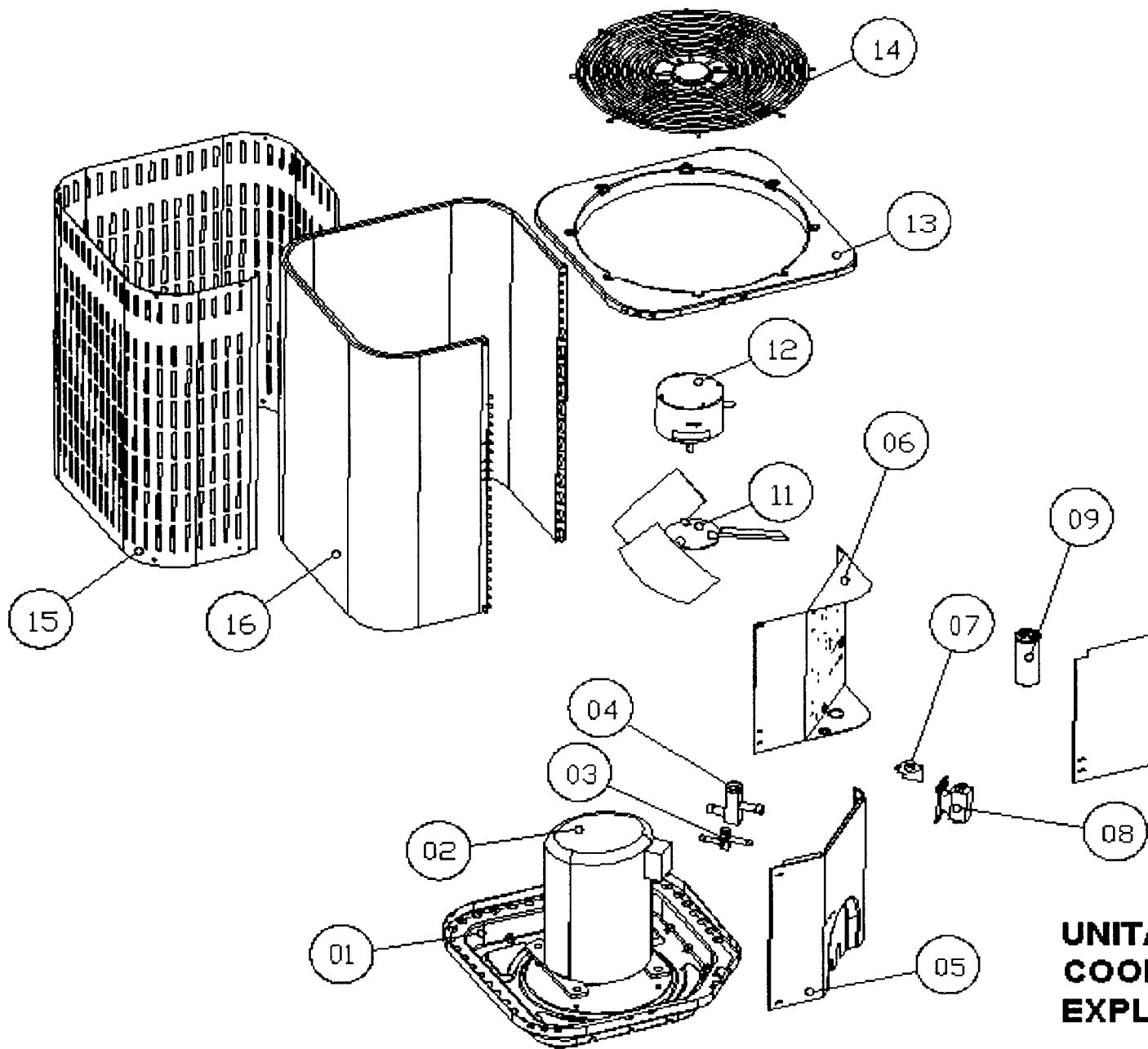

UNIT  
COOL  
EXPL

<b>HEAT CONTROLLER C-SERIES PARTS LIST</b>			<b>RSC1018-1</b>	<b>RSC1024-1</b>	<b>RSC1030-1</b>
			<b>1.5T</b>	<b>2T</b>	<b>2.5T</b>
			<b>Chass B</b>	<b>Chass B</b>	<b>Chass B</b>
<b>S/N</b>	<b>Part Number</b>	<b>Description</b>	<b>5/16", H20, 18FPI (20), 22.5" Ht</b>	<b>5/16", H20, 22 FPI, 22.5" Ht</b>	<b>3/8", H20, 22FPI, 22.5" Ht</b>
	550815	Accumulator, 1.5T - 3T			
	550818	Accumulator, 3.5T - 5T			
1	654500	Base Pan, Chassis B	1	1	1
1	654535	Base Pan, Chassis C			
7	654534	Bracket, Wire Partition, Cool	1	1	1
	654557	Bracket, Wire Partition, HP			
9	450360	Capacitor 25/7.5/370	1		
9	450361	Capacitor 30/7.5/370		1	
9	450362	Capacitor 35/7.5/370			1
9	450370	Capacitor 45/7.5/370			
9	450364	Capacitor 40/7.5/440			
9	450376	Capacitor 60/7.5/440			
9	450502	Capacitor 80/7.5/370			
9	450371	Capacitor 50/7.5/370			
9	450372	Capacitor 55/7.5/370			
9	450505	Capacitor 60/7.5/370			
	370106080001	Check Valve			
15	654553	Coil Jacket, B, H20	1	1	
15	654572	Coil Jacket, B, H20, 3/8"			1
15	654554	Coil Jacket, B, H24			
15	654573	Coil Jacket, B, H24, 3/8"			
15	654541	Coil Jacket, B, H30			
15	654574	Coil Jacket, B, H30, 3/8"			
15	654575	Coil Jacket, C, H24, 3/8"			
15	654576	Coil Jacket, C, H30, 3/8"			
15	654577	Coil Jacket, C, H36, 3/8"			
2	194200010004	Compressor -			
2	054005	Compressor	1		
2	054040	Compressor		1	
2	054016	Compressor			1
2	054036	Compressor			
2	53240	Compressor			
2	053253	Compressor			
2	053256	Compressor			
2	194200010005	Compressor			
2	194200010006	Compressor			
2	053152	Compressor			
2	053202	Compressor			
2	053246	Compressor			
2	053213	Compressor			
2	053261	Compressor			
	454252	Compressor grommet	4	4	4
	454250	Compressor grommet			

<b>HEAT CONTROLLER C-SERIES PARTS LIST</b>			<b>RSC1018-1</b>	<b>RSC1024-1</b>	<b>RSC1030-1</b>
			<b>1.5T</b>	<b>2T</b>	<b>2.5T</b>
			<b>Chass B</b>	<b>Chass B</b>	<b>Chass B</b>
<b>S/N</b>	<b>Part Number</b>	<b>Description</b>	<b>5/16", H20, 18FPI (20), 22.5" Ht</b>	<b>5/16", H20, 22 FPI, 22.5" Ht</b>	<b>3/8", H20, 22FPI, 22.5" Ht</b>
	453150	Contactora, 2 pole, 25A	1	1	1
	453770	Contactora, 2 pole, 40A			
6	654504	Control Panel Box, Chassis B	1	1	1
6	654536	Control Panel Box, Chassis C			
10	654505	Cover, Control, Chassis B	1	1	1
10	654537	Cover, Control, Chassis C			
	60000	Crankcase Heater			
	194200010007	Drier, HP, 30g			
	194200010008	Drier, HP, 25g			
	550754	Expansion Valve, 1.5T - 3T			
	550764	Expansion Valve, 3.5T - 5T			
11	259000	Fan - Alum 18" 3 Blade	1	1	1
11	259001	Fan - Alum 18" 4 Blade			
11	259003	Fan - Alum 22"			
	550505	Flowrator-3 Pass, 0.144" feeder			
	550510	Flowrator-4 Pass, 0.144" feeder			
	550515	Flowrator-5 Pass, 3/16" feeder			
	550517	Flowrator-6 Pass, 0.144" feeder			
	550508	Flowrator-3 Pass, 3/16" feeder			
	550512	Flowrator-4 Pass, 3/16" feeder			
	550519	Flowrator-5 Pass, 3/16" feeder			
14	654547	Grille Assembly, Chassis B	1	1	1
14	654514	Grille Assembly, Chassis C			
12	3590A0	Motor, 1/6HP, 60Hz	1	1	1
12	359001	Motor, 1/5HP, 60Hz			
12	359004	Motor, 1/4HP, 60Hz			
16	373108250001	Outdoor Coil - B, H20, 5/16", 20FPI	1	1	
16	373108060001	Outdoor Coil - B, H20, 3/8", 20FPI			1
16	373108410001	Outdoor Coil - B, H24, 3/8", 20FPI			
16	373108470001	Outdoor Coil - B, H30, 3/8", 20FPI			
16	373108230001	Outdoor Coil - B, H20, 5/16", 18FPI			
16	373108800001	Outdoor Coil - B, H20, 3/8", 18FPI			
16	373108960081	Outdoor Coil - B, H20, 3/8", 18FPI			
16	373108740001	Outdoor Coil - B, H24, 5/16", 18FPI			
16	373108610001	Outdoor Coil - B, H30, 3/8", 18FPI, 5 route			
16	373108870001	Outdoor Coil - B, H30, 3/8", 18FPI, 3 route			
16	373208130001	Outdoor Coil - C, H24, 3/8", 18FPI, 4 route			
16	373208390001	Outdoor Coil - C, H24, 3/8", 18FPI, 3 route			
16	373208150001	Outdoor Coil - C, H24, 3/8", 18FPI, 4 route			
16	373208080001	Outdoor Coil - C, H30, 3/8", 18FPI			
16	373208230001	Outdoor Coil - C, H36, 3/8", 18FPI, 6 route			
16	373208250001	Outdoor Coil - C, H36, 3/8", 18FPI, 6 route			

HEAT CONTROLLER C-SERIES PARTS LIST			RSC1018-1	RSC1024-1	RSC1030-1
			1.5T	2T	2.5T
			Chass B	Chass B	Chass B
S/N	Part Number	Description	5/16", H20, 18FPI (20), 22.5" Ht	5/16", H20, 22 FPI, 22.5" Ht	3/8", H20, 22FPI, 22.5" Ht
	550541	Piston, 0.045"			
	550530	Piston, 0.053" (ID/OD)	1		
	550532	Piston, 0.055" (ID/OD)			
	550535	Piston, 0.059" (ID/OD)		1	
	550555	Piston, 0.062"			
	550536	Piston, 0.063"			
	550531	Piston, 0.065" (indoor)			1
	550538	Piston, 0.070" (indoor)			
	550560	Piston, 0.072" (indoor)			
	550542	Piston, 0.076" (indoor)			
	550554	Piston, 0.078" (indoor)			
	550543	Piston, 0.082" (indoor)			
	550544	Piston, 0.084" (indoor)			
	550539	Piston, 0.090" (indoor)			
	550549	Piston, 0.098" (indoor)			
	550561	Piston, 0.101" (indoor)			
	550557	Piston, HP Mixing, 157			
5	654563	Panel, Bottom, B, H24, 3/8"			
5	654503	Panel, Bottom, B, H30			
5	654509	Panel, Bottom, B, H30, 3/8"			
5	654567	Panel, Bottom, C, H24, 3/8"			
5	654568	Panel, Bottom, C, H30, 3/8"			
5	654569	Panel, Bottom, C, H36, 3/8"			
	550790	Reversing Valve 1.5T - 3T			
	550792	Reversing Valve, 3.5T - 5T			
4	550803	Shut-off Valve 3/4"	1	1	1
3	550802	Shut-off Valve 3/8"	1	1	1
4	550806	Shut-off Valve 7/8"			
	451045	Terminal Block (451045)			
	454391	Thermostat - Defrost			
13	654510	Top Cover Grille, Chassis B	1	1	1
13	654540	Top Cover Grille, Chassis C			
	373102010001	Wire PVC tube, Chassis B	1	1	1
	373102020001	Wire PVC tube, Chassis C			

HEAT CONTROLLER C-SERIES PARTS LIST		RSC1036-1	RSC1042-1	RSC1048-1	RSC1060-1 RSC1060-3
		RSC1036-3		RSC1048-3	RSC1060-4
		3T	3.5T	4T	5T
		Chass B	Chass B	Chass B	Chass C
Part Number	Description	3/8", H24, 18FPI, 26.5" Ht	3/8", H30, 18FPI, 32.5" Ht	3/8", H30, 22FPI, 32.5" Ht	3/8" H30, 18FPI, 32.5" Ht.
550815	Accumulator, 1.5T - 3T				
550818	Accumulator, 3.5T - 5T				
654500	Base Pan, Chassis B	1	1	1	
654535	Base Pan, Chassis C				1
654534	Bracket, Wire Partition, Cool	1	1	1	1
654557	Bracket, Wire Partition, HP				
450360	Capacitor 25/7.5/370				
450361	Capacitor 30/7.5/370				
450362	Capacitor 35/7.5/370				
450370	Capacitor 45/7.5/370			1	
450364	Capacitor 40/7.5/440		1		
450376	Capacitor 60/7.5/440				
450502	Capacitor 80/7.5/370				
450371	Capacitor 50/7.5/370	1			
450372	Capacitor 55/7.5/370				
450505	Capacitor 60/7.5/370				1
370106080001	Check Valve				
654553	Coil Jacket, B, H20				
654572	Coil Jacket, B, H20, 3/8"				
654554	Coil Jacket, B, H24				
654573	Coil Jacket, B, H24, 3/8"	1			
654541	Coil Jacket, B, H30				
654574	Coil Jacket, B, H30, 3/8"		1	1	
654575	Coil Jacket, C, H24, 3/8"				
654576	Coil Jacket, C, H30, 3/8"				1
654577	Coil Jacket, C, H36, 3/8"				
194200010004	Compressor - AVF5533EXN				
054005	Compressor				
054040	Compressor				
054016	Compressor				
054036	Compressor	1			
53240	Compressor		1		
053253	Compressor			1	
053256	Compressor				1
194200010005	Compressor				
194200010006	Compressor				
053152	Compressor				
053202	Compressor				
053246	Compressor				
053213	Compressor				
053261	Compressor				
454252	Compressor grommet	4			
454250	Compressor grommet		4	4	4

HEAT CONTROLLER C-SERIES PARTS LIST		RSC1036-1	RSC1042-1	RSC1048-1	RSC1060-1 RSC1060-3
		RSC1036-3		RSC1048-3	RSC1060-4
		3T	3.5T	4T	5T
		Chass B	Chass B	Chass B	Chass C
Part Number	Description	3/8", H24, 18FPI, 26.5" Ht	3/8", H30, 18FPI, 32.5" Ht	3/8", H30, 22FPI, 32.5" Ht	3/8" H30, 18FPI, 32.5" Ht
453150	Contactora, 2 pole, 25A	1	1		
453770	Contactora, 2 pole, 40A			1	1
654504	Control Panel Box, Chassis B	1	1	1	
654536	Control Panel Box, Chassis C				1
654505	Cover, Control, Chassis B	1	1	1	
654537	Cover, Control, Chassis C				1
60000	Crankcase Heater				
194200010007	Drier, HP, 30g				
194200010008	Drier, HP, 25g				
550754	Expansion Valve, 1.5T - 3T				
550764	Expansion Valve, 3.5T - 5T				
259000	Fan - Alum 18" 3 Blade	1			
259001	Fan - Alum 18" 4 Blade		1	1	
259003	Fan - Alum 22"				1
550505	Flowrator-3 Pass, 0.144" feeder				
550510	Flowrator-4 Pass, 0.144" feeder				
550515	Flowrator-5 Pass, 3/16" feeder				1
550517	Flowrator-6 Pass, 0.144" feeder				
550508	Flowrator-3 Pass, 3/16" feeder				
550512	Flowrator-4 Pass, 3/16" feeder				
550519	Flowrator-5 Pass, 3/16" feeder				
654547	Grille Assembly, Chassis B	1	1	1	
654514	Grille Assembly, Chassis C				1
3590A0	Motor, 1/6HP, 60Hz	1			
359001	Motor, 1/5HP, 60Hz		1	1	
359004	Motor, 1/4HP, 60Hz				1
373108250001	Outdoor Coil - B, H20, 5/16", 20FPI				
373108060001	Outdoor Coil - B, H20, 3/8", 20FPI				
373108410001	Outdoor Coil - B, H24, 3/8", 20FPI				
373108470001	Outdoor Coil - B, H30, 3/8", 20FPI			1	
373108230001	Outdoor Coil - B, H20, 5/16", 18FPI				
373108800001	Outdoor Coil - B, H20, 3/8", 18FPI				
373108960081	Outdoor Coil - B, H20, 3/8", 18FPI				
373108740001	Outdoor Coil - B, H24, 5/16", 18FPI				
373108610001	Outdoor Coil - B, H30, 3/8", 18FPI, 5 route				
373108870001	Outdoor Coil - B, H30, 3/8", 18FPI, 3 route				
373208130001	Outdoor Coil - C, H24, 3/8", 18FPI, 4 route				
373208390001	Outdoor Coil - C, H24, 3/8", 18FPI, 3 route				
373208150001	Outdoor Coil - C, H24, 3/8", 18FPI, 4 route				
373208080001	Outdoor Coil - C, H30, 3/8", 18FPI				1
373208230001	Outdoor Coil - C, H36, 3/8", 18FPI, 6 route				
373208250001	Outdoor Coil - C, H36, 3/8", 18FPI, 6 route				

<b>HEAT CONTROLLER C-SERIES PARTS LIST</b>		RSC1036-1 RSC1036-3	RSC1042-1	RSC1048-1 RSC1048-3	RSC1060-1 RSC1060-3 RSC1060-4
		<b>3T</b>	<b>3.5T</b>	<b>4T</b>	<b>5T</b>
		Chass B	Chass B	Chass B	Chass C
<b>Part Number</b>	<b>Description</b>	3/8", H24, 18FPI, 26.5" Ht	3/8", H30, 18FPI, 32.5" Ht	3/8", H30, 22FPI, 32.5" Ht	3/8" H30, 18FPI, 32.5" Ht.
550541	Piston, 0.045"				
550530	Piston, 0.053" (ID/OD)				
550532	Piston, 0.055" (ID/OD)				
550535	Piston, 0.059" (ID/OD)				
550555	Piston, 0.062"				
550536	Piston, 0.063"				
550531	Piston, 0.065" (indoor)				
550538	Piston, 0.070" (indoor)				
550560	Piston, 0.072" (indoor)	1			
550542	Piston, 0.076" (indoor)		1		
550554	Piston, 0.078" (indoor)				
550543	Piston, 0.082" (indoor)				
550544	Piston, 0.084" (indoor)			1	
550539	Piston, 0.090" (indoor)				
550549	Piston, 0.098" (indoor)				1
550561	Piston, 0.101" (indoor)				
550557	Piston, HP Mixing, 157				
654563	Panel, Bottom, B, H24, 3/8"	1			
654503	Panel, Bottom, B, H30				
654509	Panel, Bottom, B, H30, 3/8"		1	1	
654567	Panel, Bottom, C, H24, 3/8"				
654568	Panel, Bottom, C, H30, 3/8"				1
654569	Panel, Bottom, C, H36, 3/8"				
550790	Reversing Valve 1.5T - 3T				
550792	Reversing Valve, 3.5T - 5T				
550803	Shut-off Valve 3/4"	1			
550802	Shut-off Valve 3/8"	1	1	1	1
550806	Shut-off Valve 7/8"		1	1	1
451045	Terminal Block (451045)				
454391	Thermostat - Defrost				
654510	Top Cover Grille, Chassis B	1	1	1	
654540	Top Cover Grille, Chassis C				1
373102010001	Wire PVC tube, Chassis B	1	1	1	
373102020001	Wire PVC tube, Chassis C				1

<b>HEAT CONTROLLER C-SERIES PARTS LIST</b>		<b>RSC1218-1</b>	<b>RSC1224-1</b>	<b>RSC1230-1</b>	<b>RSC1236-1</b>
		<b>1.5T</b>	<b>2T</b>	<b>2.5T</b>	<b>3T</b>
		<b>Chass B</b>	<b>Chass B</b>	<b>Chass B</b>	<b>Chass B</b>
<b>Part Number</b>	<b>Description</b>	<b>5/16", H20, 22FPI, 22.5" Ht</b>	<b>5/16", H20, 22FPI, 22.5" Ht</b>	<b>3/8", H24, 22FPI, 26.5" Ht.</b>	<b>3/8", H30, 22FPI, 32.5" Ht.</b>
550815	Accumulator, 1.5T - 3T				
550818	Accumulator, 3.5T - 5T				
654500	Base Pan, Chassis B	1	1	1	1
654535	Base Pan, Chassis C				
654534	Bracket, Wire Partition, Cool	1	1	1	1
654557	Bracket, Wire Partition, HP				
450360	Capacitor 25/7.5/370				
450361	Capacitor 30/7.5/370	1			
450362	Capacitor 35/7.5/370				
450370	Capacitor 45/7.5/370		1	1	
450364	Capacitor 40/7.5/440				
450376	Capacitor 60/7.5/440				
450502	Capacitor 80/7.5/370				
450371	Capacitor 50/7.5/370				1
450372	Capacitor 55/7.5/370				
450505	Capacitor 60/7.5/370				
370106080001	Check Valve				
654553	Coil Jacket, B, H20	1	1		
654572	Coil Jacket, B, H20, 3/8"				
654554	Coil Jacket, B, H24				
654573	Coil Jacket, B, H24, 3/8"			1	
654541	Coil Jacket, B, H30				
654574	Coil Jacket, B, H30, 3/8"				1
654575	Coil Jacket, C, H24, 3/8"				
654576	Coil Jacket, C, H30, 3/8"				
654577	Coil Jacket, C, H36, 3/8"				
00010004	Compressor -				
054005	Compressor				
054040	Compressor				
054016	Compressor				
054036	Compressor				
53240	Compressor				
053253	Compressor				
053256	Compressor				
194200010005	Compressor	1			
194200010006	Compressor		1		
053152	Compressor			1	
053202	Compressor				1
053246	Compressor				
053213	Compressor				
053261	Compressor				
454252	Compressor grommet	4	4		
454250	Compressor grommet			4	4

<b>HEAT CONTROLLER C-SERIES PARTS LIST</b>		RSC1218-1	RSC1224-1	RSC1230-1	RSC1236-1
		1.5T	2T	2.5T	3T
		Chass B	Chass B	Chass B	Chass B
Part Number	Description	5/16", H20, 22FPI, 22.5" Ht	5/16", H20, 22FPI, 22.5" Ht	3/8", H24, 22FPI, 26.5" Ht.	3/8", H30, 22FPI, 32.5" Ht
453150	Contactora, 2 pole, 25A	1	1	1	1
453770	Contactora, 2 pole, 40A				
654504	Control Panel Box, Chassis B	1	1	1	1
654536	Control Panel Box, Chassis C				
654505	Cover, Control, Chassis B	1	1	1	1
654537	Cover, Control, Chassis C				
60000	Crankcase Heater				
194200010007	Drier, HP, 30g				
194200010008	Drier, HP, 25g				
550754	Expansion Valve, 1.5T - 3T				
550764	Expansion Valve, 3.5T - 5T				
259000	Fan - Alum 18" 3 Blade	1	1	1	1
259001	Fan - Alum 18" 4 Blade				
259003	Fan - Alum 22"				
550505	Flowrator-3 Pass, 0.144" feeder				
550510	Flowrator-4 Pass, 0.144" feeder				
550515	Flowrator-5 Pass, 3/16" feeder				
550517	Flowrator-6 Pass, 0.144" feeder				
550508	Flowrator-3 Pass, 3/16" feeder				
550512	Flowrator-4 Pass, 3/16" feeder				
550519	Flowrator-5 Pass, 3/16" feeder				
654547	Grille Assembly, Chassis B	1	1	1	1
654514	Grille Assembly, Chassis C				
3590A0	Motor, 1/6HP, 60Hz	1	1	1	1
359001	Motor, 1/5HP, 60Hz				
359004	Motor, 1/4HP, 60Hz				
373108250001	Outdoor Coil - B, H20, 5/16", 20FPI	1	1		
373108060001	Outdoor Coil - B, H20, 3/8", 20FPI				
373108410001	Outdoor Coil - B, H24, 3/8", 20FPI			1	
373108470001	Outdoor Coil - B, H30, 3/8", 20FPI				1
373108230001	Outdoor Coil - B, H20, 5/16", 18FPI				
373108800001	Outdoor Coil - B, H20, 3/8", 18FPI				
373108960081	Outdoor Coil - B, H20, 3/8", 18FPI				
373108740001	Outdoor Coil - B, H24, 5/16", 18FPI				
373108610001	Outdoor Coil - B, H30, 3/8", 18FPI, 5 route				
373108870001	Outdoor Coil - B, H30, 3/8", 18FPI, 3 route				
373208130001	Outdoor Coil - C, H24, 3/8", 18FPI, 4 route				
373208390001	Outdoor Coil - C, H24, 3/8", 18FPI, 3 route				
373208150001	Outdoor Coil - C, H24, 3/8", 18FPI, 4 route				
373208080001	Outdoor Coil - C, H30, 3/8", 18FPI				
373208230001	Outdoor Coil - C, H36, 3/8", 18FPI, 6 route				
373208250001	Outdoor Coil - C, H36, 3/8", 18FPI, 6 route				

HEAT CONTROLLER C-SERIES PARTS LIST		RSC1218-1	RSC1224-1	RSC1230-1	RSC1236-1
		1.5T	2T	2.5T	3T
		Chass B	Chass B	Chass B	Chass B
Part Number	Description	5/16", H20, 22FPI, 22.5" Ht	5/16", H20, 22FPI, 22.5" Ht	3/8", H24, 22FPI, 26.5" Ht.	3/8", H30, 22FPI, 32.5" Ht.
550541	Piston, 0.045"				
550530	Piston, 0.053" (ID/OD)				
550532	Piston, 0.055" (ID/OD)	1			
550535	Piston, 0.059" (ID/OD)				
550555	Piston, 0.062"				
550536	Piston, 0.063"				
550531	Piston, 0.065" (indoor)		1		
550538	Piston, 0.070" (indoor)			1	
550560	Piston, 0.072" (indoor)				
550542	Piston, 0.076" (indoor)				
550554	Piston, 0.078" (indoor)				1
550543	Piston, 0.082" (indoor)				
550544	Piston, 0.084" (indoor)				
550539	Piston, 0.090" (indoor)				
550549	Piston, 0.098" (indoor)				
550561	Piston, 0.101" (indoor)				
550557	Piston, HP Mixing, 157				
654563	Panel, Bottom, B, H24, 3/8"			1	
654503	Panel, Bottom, B, H30				
654509	Panel, Bottom, B, H30, 3/8"				1
654567	Panel, Bottom, C, H24, 3/8"				
654568	Panel, Bottom, C, H30, 3/8"				
654569	Panel, Bottom, C, H36, 3/8"				
550790	Reversing Valve 1.5T - 3T				
550792	Reversing Valve, 3.5T - 5T				
550803	Shut-off Valve 3/4"	1	1	1	1
550802	Shut-off Valve 3/8"	1	1	1	1
550806	Shut-off Valve 7/8"				
451045	Terminal Block (451045)				
454391	Thermostat - Defrost				
654510	Top Cover Grille, Chassis B	1	1	1	1
654540	Top Cover Grille, Chassis C				
373102010001	Wire PVC tube, Chassis B	1	1	1	1
373102020001	Wire PVC tube, Chassis C				

<b>HEAT CONTROLLER C-SERIES PARTS LIST</b>			<b>RSC1242-1</b>	<b>RSC1248-1</b>	<b>RSC1260-1</b>
			<b>3.5T</b>	<b>4T</b>	<b>5T</b>
			<b>Chass C</b>	<b>Chass C</b>	<b>Chass C</b>
<b>S/N</b>	<b>Part Number</b>	<b>Description</b>	<b>3/8", H24, 18FPI, 26.5" Ht.</b>	<b>3/8", H30, 18FPI, 32.5" Ht.</b>	<b>3/8", H36, 18FPI, 38.5" Ht.</b>
	550815	Accumulator, 1.5T - 3T			
	550818	Accumulator, 3.5T - 5T			
1	654500	Base Pan, Chassis B			
1	654535	Base Pan, Chassis C	1	1	1
7	654534	Bracket, Wire Partition, Cool	1	1	1
	654557	Bracket, Wire Partition, HP			
9	450360	Capacitor 25/7.5/370			1
9	450361	Capacitor 30/7.5/370			
9	450362	Capacitor 35/7.5/370			
9	450370	Capacitor 45/7.5/370			
9	450364	Capacitor 40/7.5/440			
9	450376	Capacitor 60/7.5/440		1	
9	450502	Capacitor 80/7.5/370			1
9	450371	Capacitor 50/7.5/370			
9	450372	Capacitor 55/7.5/370	1		
9	450505	Capacitor 60/7.5/370			
	370106080001	Check Valve			
15	654553	Coil Jacket, B, H20			
15	654572	Coil Jacket, B, H20, 3/8"			
15	654554	Coil Jacket, B, H24			
15	654573	Coil Jacket, B, H24, 3/8"			
15	654541	Coil Jacket, B, H30			
15	654574	Coil Jacket, B, H30, 3/8"			
15	654575	Coil Jacket, C, H24, 3/8"	1		
15	654576	Coil Jacket, C, H30, 3/8"		1	
15	654577	Coil Jacket, C, H36, 3/8"			1
2	194200010004	Compressor -			
2	054005	Compressor			
2	054040	Compressor			
2	054016	Compressor			
2	054036	Compressor			
2	53240	Compressor			
2	053253	Compressor			
2	053256	Compressor			
2	194200010005	Compressor			
2	194200010006	Compressor			
2	053152	Compressor			
2	053202	Compressor			
2	053246	Compressor	1		
2	053213	Compressor		1	
2	053261	Compressor			1
	454252	Compressor grommet			
	454250	Compressor grommet	4	4	4

HEAT CONTROLLER C-SERIES PARTS LIST			RSC1242-1	RSC1248-1	RSC1260-1
			3.5T	4T	5T
			Chass C	Chass C	Chass C
S/N	Part Number	Description	3/8", H24, 18FPI, 26.5" Ht.	3/8", H30, 18FPI, 32.5" Ht.	3/8", H36, 18FPI, 38.5" Ht.
	453150	Contactora, 2 pole, 25A	1		
	453770	Contactora, 2 pole, 40A		1	1
6	654504	Control Panel Box, Chassis B			
6	654536	Control Panel Box, Chassis C	1	1	1
10	654505	Cover, Control, Chassis B			
10	654537	Cover, Control, Chassis C	1	1	1
	60000	Crankcase Heater			
	194200010007	Drier, HP, 30g			
	194200010008	Drier, HP, 25g			
	550754	Expansion Valve, 1.5T - 3T			
	550764	Expansion Valve, 3.5T - 5T			
11	259000	Fan - Alum 18" 3 Blade			
11	259001	Fan - Alum 18" 4 Blade			
11	259003	Fan - Alum 22"	1	1	1
	550505	Flowrator-3 Pass, 0.144" feeder			
	550510	Flowrator-4 Pass, 0.144" feeder	1		
	550515	Flowrator-5 Pass, 3/16" feeder		1	
	550517	Flowrator-6 Pass, 0.144" feeder			1
	550508	Flowrator-3 Pass, 3/16" feeder			
	550512	Flowrator-4 Pass, 3/16" feeder			
	550519	Flowrator-5 Pass, 3/16" feeder			
14	654547	Grille Assembly, Chassis B			
14	654514	Grille Assembly, Chassis C	1	1	1
12	3590A0	Motor, 1/6HP, 60Hz			
12	359001	Motor, 1/5HP, 60Hz			
12	359004	Motor, 1/4HP, 60Hz	1	1	1
16	373108250001	Outdoor Coil - B, H20, 5/16", 20FPI			
16	373108060001	Outdoor Coil - B, H20, 3/8", 20FPI			
16	373108410001	Outdoor Coil - B, H24, 3/8", 20FPI			
16	373108470001	Outdoor Coil - B, H30, 3/8", 20FPI			
16	373108230001	Outdoor Coil - B, H20, 5/16", 18FPI			
16	373108800001	Outdoor Coil - B, H20, 3/8", 18FPI			
16	373108960081	Outdoor Coil - B, H20, 3/8", 18FPI			
16	373108740001	Outdoor Coil - B, H24, 5/16", 18FPI			
16	373108610001	Outdoor Coil - B, H30, 3/8", 18FPI, 5 route			
16	373108870001	Outdoor Coil - B, H30, 3/8", 18FPI, 3 route			
16	373208130001	Outdoor Coil - C, H24, 3/8", 18FPI, 4 route	1		
16	373208390001	Outdoor Coil - C, H24, 3/8", 18FPI, 3 route			
16	373208150001	Outdoor Coil - C, H24, 3/8", 18FPI, 4 route			
16	373208080001	Outdoor Coil - C, H30, 3/8", 18FPI		1	
16	373208230001	Outdoor Coil - C, H36, 3/8", 18FPI, 6 route			1
16	373208250001	Outdoor Coil - C, H36, 3/8", 18FPI, 6 route			

<b>HEAT CONTROLLER C-SERIES PARTS LIST</b>			<b>RSC1242-1</b>	<b>RSC1248-1</b>	<b>RSC1260-1</b>
			<b>3.5T</b>	<b>4T</b>	<b>5T</b>
			<b>Chass C</b>	<b>Chass C</b>	<b>Chass C</b>
<b>S/N</b>	<b>Part Number</b>	<b>Description</b>	<b>3/8", H24, 18FPI, 26.5" Ht.</b>	<b>3/8", H30, 18FPI, 32.5" Ht.</b>	<b>3/8", H36, 18FPI, 38.5" Ht.</b>
	550541	Piston, 0.045"			
	550530	Piston, 0.053" (ID/OD)			
	550532	Piston, 0.055" (ID/OD)			
	550535	Piston, 0.059" (ID/OD)			
	550555	Piston, 0.062"			
	550536	Piston, 0.063"			
	550531	Piston, 0.065" (indoor)			
	550538	Piston, 0.070" (indoor)			
	550560	Piston, 0.072" (indoor)			
	550542	Piston, 0.076" (indoor)			
	550554	Piston, 0.078" (indoor)			
	550543	Piston, 0.082" (indoor)	1		
	550544	Piston, 0.084" (indoor)			
	550539	Piston, 0.090" (indoor)		1	
	550549	Piston, 0.098" (indoor)			
	550561	Piston, 0.101" (indoor)			1
	550557	Piston, HP Mixing, 157			
5	654563	Panel, Bottom, B, H24, 3/8"			
5	654503	Panel, Bottom, B, H30			
5	654509	Panel, Bottom, B, H30, 3/8"			
5	654567	Panel, Bottom, C, H24, 3/8"	1		
5	654568	Panel, Bottom, C, H30, 3/8"		1	
5	654569	Panel, Bottom, C, H36, 3/8"			1
	550790	Reversing Valve 1.5T - 3T			
	550792	Reversing Valve, 3.5T - 5T			
4	550803	Shut-off Valve 3/4"			
3	550802	Shut-off Valve 3/8"	1	1	1
4	550806	Shut-off Valve 7/8"	1	1	1
	451045	Terminal Block (451045)			
	454391	Thermostat - Defrost			
13	654510	Top Cover Grille, Chassis B			
13	654540	Top Cover Grille, Chassis C	1	1	1
	373102010001	Wire PVC tube, Chassis B			
	373102020001	Wire PVC tube, Chassis C	1	1	1

**HEAT CONTROLLER INC.**  
**1900 WELLWORTH AVE**  
**JACKSON, MI 49203**  
**(517) 780-3217**