

This Owner's Manual is provided and hosted by [Appliance Factory Parts](http://www.appliancefactoryparts.com).

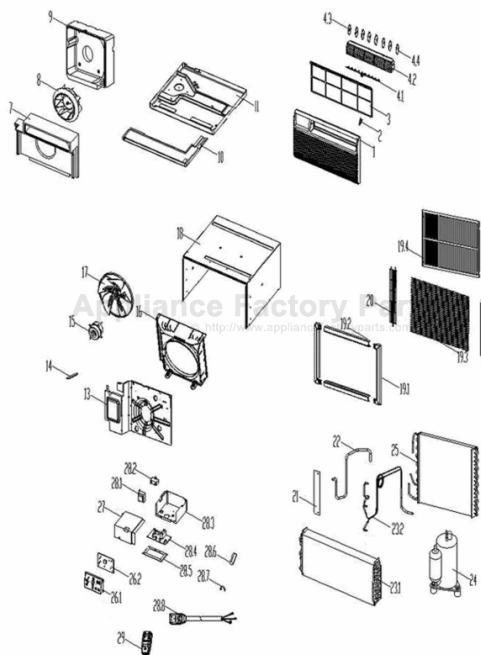

COMFORT-AIRE BG-103G Owner's Manual

[Shop genuine replacement parts for COMFORT-AIRE
BG-103G](#)



[Find Your COMFORT-AIRE Air Conditioner Parts - Select From 599 Models](#)

----- Manual continues below -----

HEAT CONTROLLER, INC.

REPLACEMENT PARTS LIST

**Room Air Conditioner with R-410A:
BG-103G**

EXPLODED VIEW

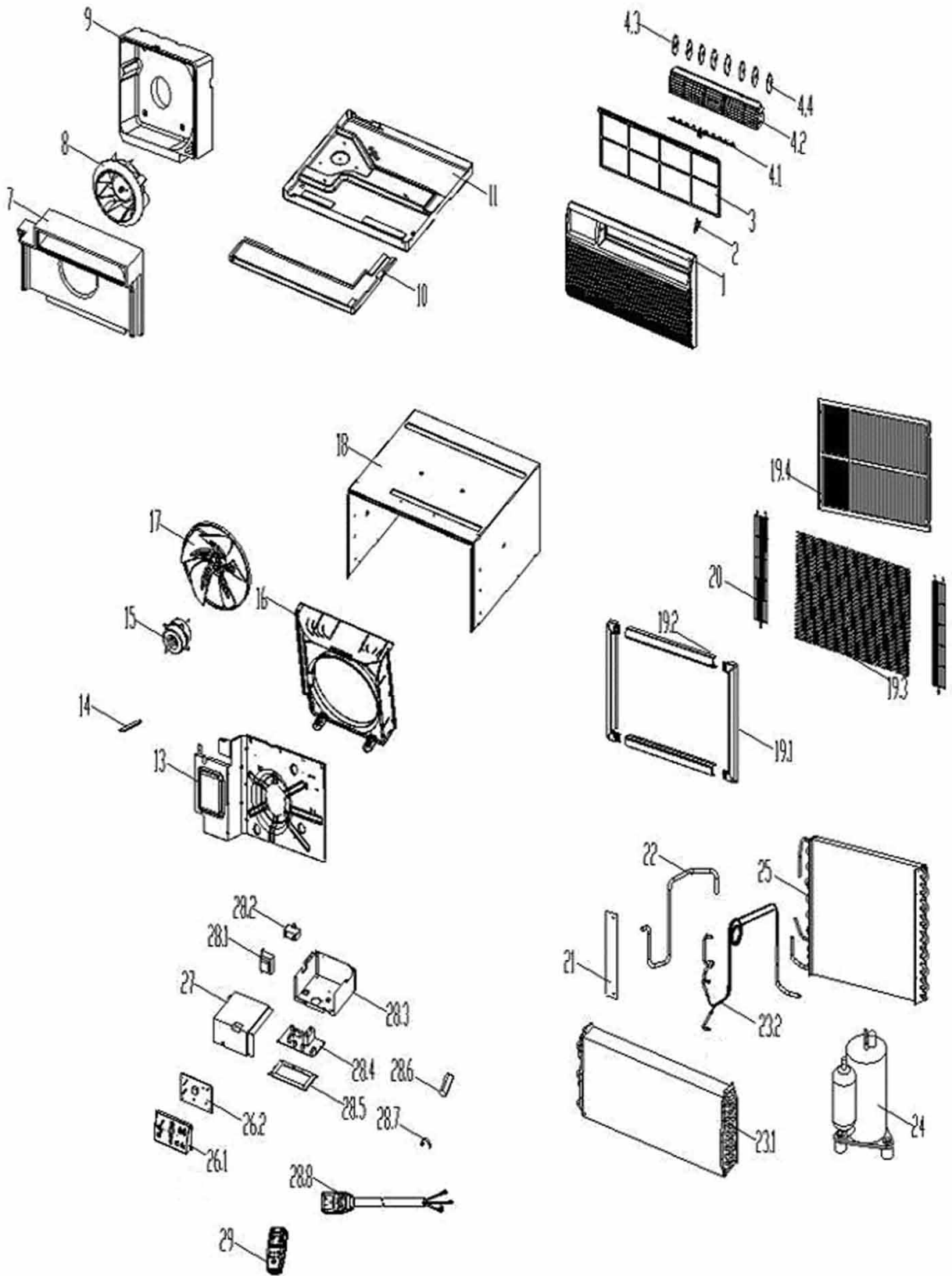

REPLACEMENT PARTS

Location	Part Name	Quantity	Part No.
1	Front panel	1	201121890037
2	Air filter guide	2	201121890003
3	Air filter	1	201121890036
4.1	Louver connection bar	2	201121890035
4.2	Horizontal louver	1	201121890043
4.3	Vertical louver	2	201121890033
4.4	Vertical louver	6	201121890034
7	Foam,front scroll	1	202221890013
8	Blower wheel	1	201100100028
9	Foam,rear scroll	1	202221390003
10	Foam,drip tray	1	202221890010
11	Chassis assembly	1	201221890062
13	Front separating board	1	201221890033
14	Link,Front separating board	1	201221890034
15	Fan motor	1	202400400952
16	Rear separating board	1	201121890053
17	Axial flow fan	1	201100300022
18	Cabinet	1	201221390086
19.1	Left and right frame bar	2	201121890008
19.2	Up and down frame bar	2	201121890007
19.3	Plastic net	1	201121890009
19.4	Sleeve rear grille	1	202921890000
20	Rear net,air inlet	2	201221890031
21	Separating board for power cord	1	201121890017
22	Discharge pipe	1	201621590227
23.1	Evaporator	1	201521590057
23.2	Capillary assembly	1	201621590224
24	Compressor	1	201400601120
25	Condenser assembly	1	201521790203
26.1	Control box	1	201121890029
26.2	Display board assembly	1	201321590006
27	Cover,E-part box	1	201221890058
28.1	Transformer	1	202300900140
28.2	Fan motor capacitor	1	202401100407
28.3	E-part box	1	201221890057
28.4	Main control board assembly	1	201321390058
28.5	Installation board for E-part box	1	201121890090
28.6	Capacitor	1	202401000410
28.7	Capacitor clamp	1	201225590021
28.8	Power cord assembly	1	202402260127
29	Remote controller	1	203355091112

Design, material, performance data and components
subject to change without notice.

HEAT CONTROLLER, INC.

1900 Wellworth Ave., Jackson, MI 49203 ♦ Ph. 517-787-2100 ♦ Fax 517-787-9341

THE QUALITY LEADER IN CONDITIONING AIR

www.heatcontroller.com