

This Owner's Manual is provided and hosted by [Appliance Factory Parts](#).

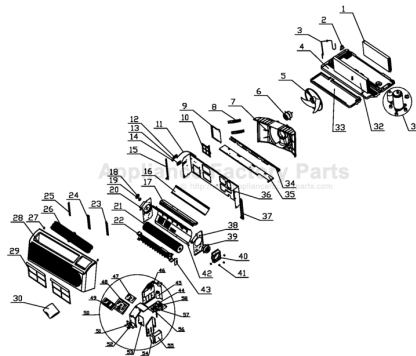

# COMFORT-AIRE EKTH15-2G Owner's Manual

[Shop genuine replacement parts for COMFORT-AIRE  
EKTH15-2G](#)



[Find Your COMFORT-AIRE Air Conditioner Parts - Select From 599 Models](#)

----- Manual continues below part list -----

## Available Replacement Parts for COMFORT-AIRE EKTH15-2G

<a href="#">42010037</a>	WIRING TERMINAL
<a href="#">42011103</a>	TERMINAL BOARD
<a href="#">10331004</a>	AXIAL FLOW FAN
<a href="#">10351002</a>	CROSS FLOW FAN
<a href="#">10371004</a>	DIVERSION CIRCLE
<a href="#">11121212</a>	FILTER
<a href="#">20001457</a>	FRONT PANEL
<a href="#">20161239</a>	LCD COVER
<a href="#">26151138</a>	BEARING HOLDER
<a href="#">30032020</a>	MAIN BOARD 1
<a href="#">30542007</a>	DISPLAY BOARD

---

*Comfort-Aire*®

 **Century**®

**MARS**  
Delivering Confidence

---

## REPLACEMENT PARTS LIST

# 265V Packaged Terminal Air Conditioner & Heat Pump:

EKTC07-2G

EKTC09-2G

EKTC12-2G

EKTC15-2G

EKTH07-2G

EKTH09-2G

EKTH12-2G

EKTH15-2G

# EXPLODED VIEW: EKTC07-2G

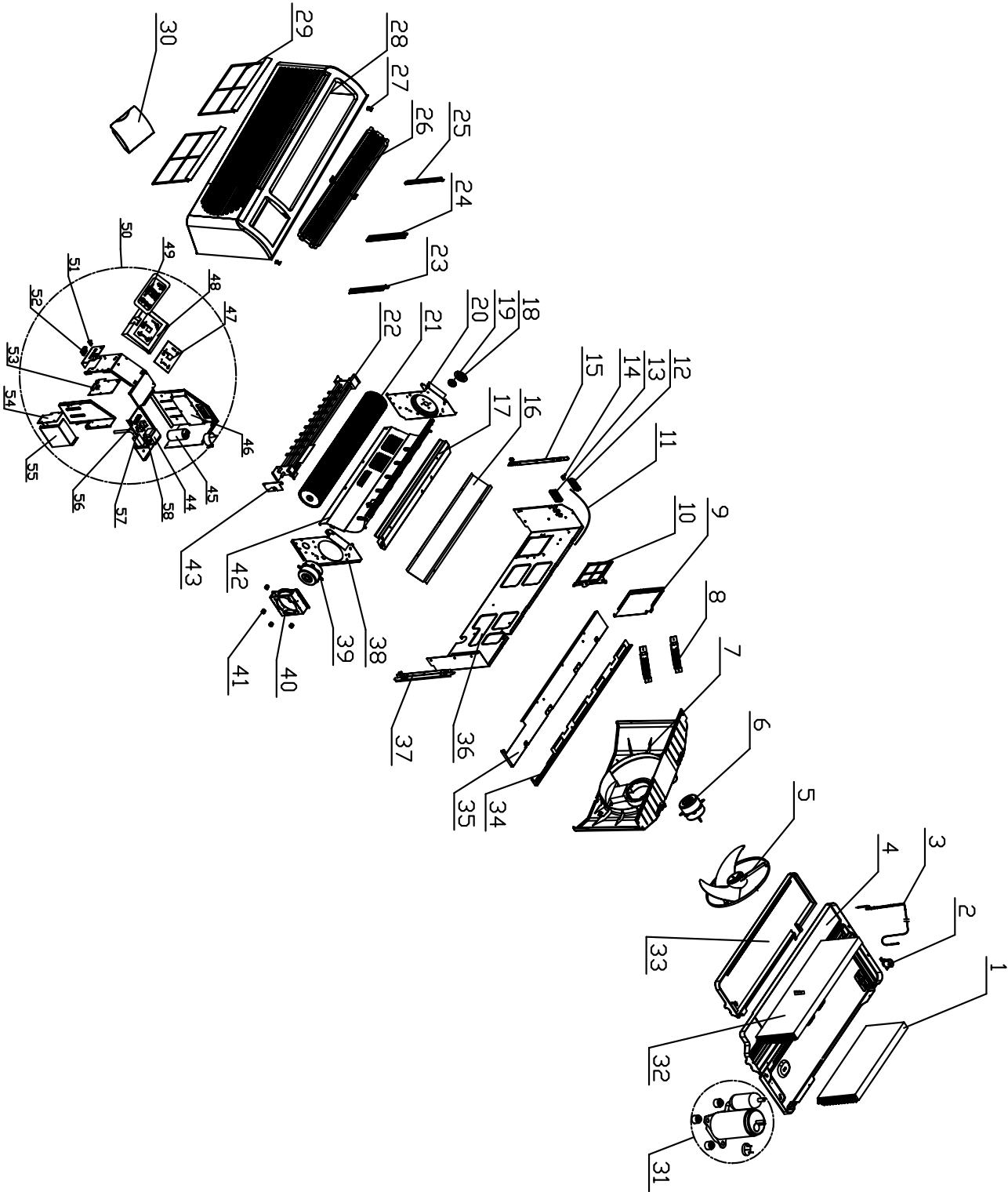

## REPLACEMENT PARTS: EKTC07-2G

NO.	Part Code	Part Description	qty
1	01101272	Condenser Assy	1
2	07100164	Drain water valve	1
3	03001424	Capillary Sub-Assy	1
4	0120102601P	Chassis Assy	1
5	10331004	Axial flow fan	1
6	150110345	Fan Motor	1
7	10371004	Diversion Circle	1
8	01381004	Middle plate	2
9	01441008	Air inlet door Sub-assy	1
10	11121213	Fresh air filter	1
11	02121014	Door thread	1
12	26231154	Cover(UP)	1
13	26231155	Cover(DOWN)	1
14	26231153	Handle	1
15	01701015	Bracket assy(L)	1
16	01471007	Protect net	1
17	02121010P	Cochlea tongue	1
18	02111010	Bearing board	1
19	26151138	Bearing rubber assy	1
20	02121008P	Air hole left board	1
21	10351002	Cross flow fan	1
22	3200102603	Electric Heater	1
23	26111139	Filter board 1	1
24	26111140	Filter board 2	1
25	26111141	Filter board 3	1
26	22411153	Wind gridiron	1
27	02111013	Front panel mtg. clips	2
28	20001457	Front Panel	1
29	11121212	Filter	2
30	20121070	Remote Control Cover	1
31	00101060	Compressor and fittings	1
32	01001066	Evaporator Assy	1
33	02121012	Heat insulation plate	1
34	01701009	Up plate bracket	1
35	01251013	Top Cover Plate Sub-Assy	1
36	01231041P	Partition plate	1
37	01701016	Bracket assy(R)	1
38	02121009P	Air hole right board	1
39	1501180204	Fan Motor	1
40	01701014P	Motor Support Sub-Assy	1
41	76711031	Damping rubber	4

***Continued on next page....***

# REPLACEMENT PARTS: EKTC07-2G

*Continued from previous page....*

No.	Part Code	Part Description	Qty.
42	01221013	Air duct sub-assy	1
43	02111009	Heater Wiring block board	1
44	43110269	Transformer	1
45	33010045	Capacitor CBB65 15uF/450V	1
46	30032021	Main PCB1	1
47	30542007	PCB	1
48	20161239	Control panel	1
49	76711007	Control panel glue gasket	1
50	0140125401	Electric Box Assy	1
51	42010037	Connector 5EHDV-02P	1
52	42010039S	Connector 5EHDV-07P	1
53	30032023	Main PCB2	1
54	01251015	Junction lid	1
55	01411050	Junction box	1
56	42011103	Terminal Board 2-8	2
57	33010089	Capacitor CBB611A 1uF/450V	1
58	33010020	Capacitor	1
Not Shown	12411904	Indoor Foam Drain Pan	1

# EXPLODED VIEW: EKTC09-2G

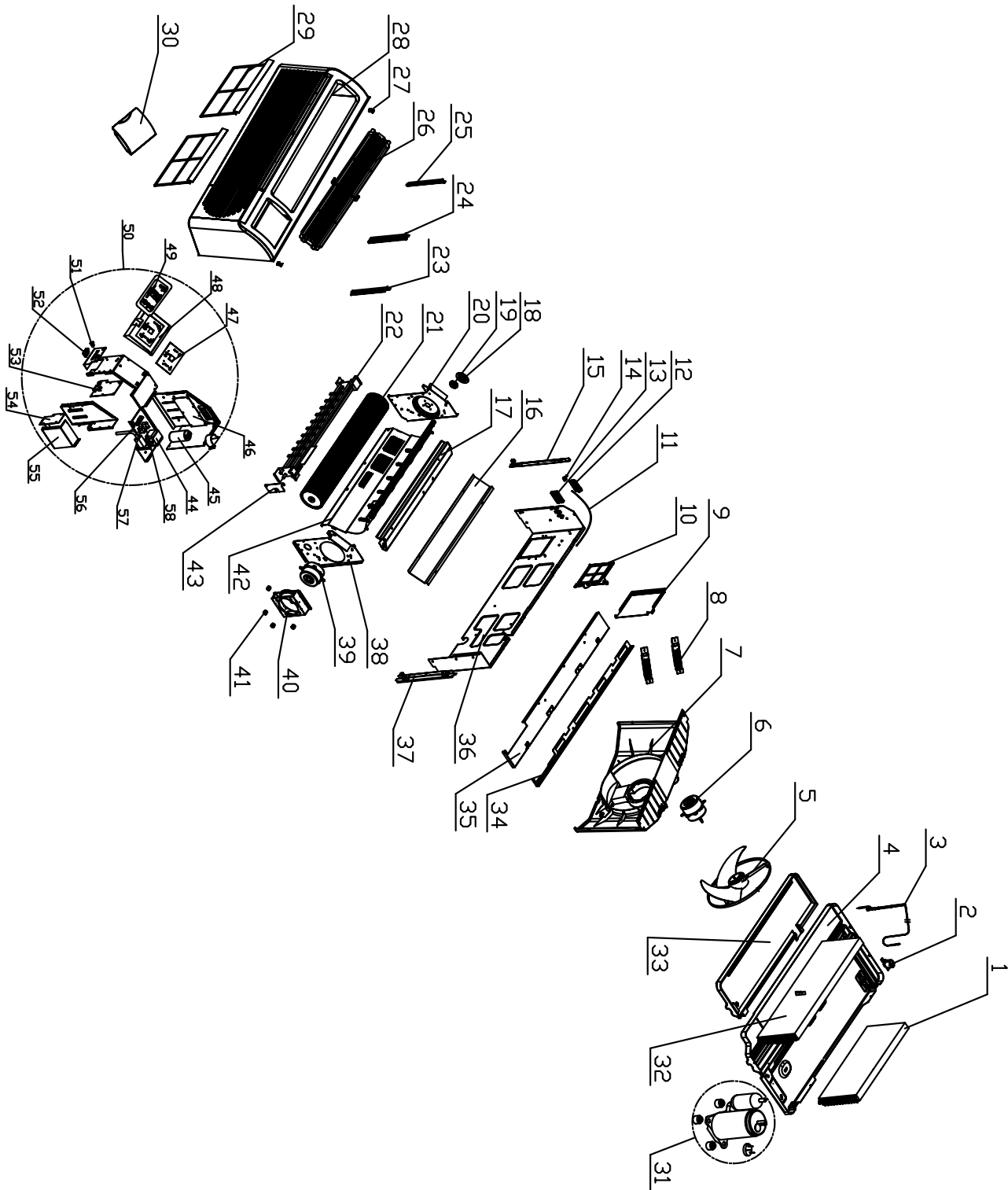

## REPLACEMENT PARTS: EKTC09-2G

NO.	Part Code	Part Description	qty
1	01101809	Condenser Assy	1
2	07100164	Drain water valve	1
3	03001079	Capillary Assy	1
4	0120102601P	Chassis Assy	1
5	10331004	Axial flow fan	1
6	150110345	Fan Motor	1
7	10371004	Diversion Circle	1
8	01381004	Middle plate	2
9	01441008	Air inlet door Sub-assy	1
10	11121213	Fresh air filter	1
11	02121014	Door thread	1
12	26231154	Cover(UP)	1
13	26231155	Cover(DOWN)	1
14	26231153	Handle	1
15	01701015	Bracket assy(L)	1
16	01471007	Protect net	1
17	02121010P	Cochlea tongue	1
18	02111010	Bearing board	1
19	26151138	Bearing rubber assy	1
20	02121008P	Air hole left board	1
21	10351002	Cross flow fan	1
22	3200102603	Electric Heater	1
23	26111139	Filter board 1	1
24	26111140	Filter board 2	1
25	26111141	Filter board 3	1
26	22411153	Wind gridiron	1
27	02111013	Front panel mtg. clips	2
28	20001457	Front Panel	1
29	11121212	Filter	2
30	20121070	Remote Control Cover	1
31	00101055	Compressor and fittings	1
32	01001043	Evaporator assy	1
33	02121012	Heat insulation plate	1
34	01701009	Up plate bracket	1
35	01251013	Top Cover Plate Sub-Assy	1
36	01231041P	Partition plate	1
37	01701016	Bracket assy(R)	1
38	02121009P	Air hole right board	1
39	1501180201	Motor(IN)	1
40	01701014P	Motor Support Sub-Assy	1
41	76711031	Damping rubber	4
42	0122101101	Air duct sub-assy	1
43	02111009	Heater Wiring block board	1

***Continued on next page....***

## REPLACEMENT PARTS: EKTC09-2G

*Continued from previous page....*

No.	Part Code	Part Description	Qty.
44	43110269	Transformer	1
45	33010045	Capacitor CBB65 15uF/450V	1
46	30032021	Main PCB1	1
47	30542007	PCB	1
48	20161239	Control panel	1
49	76711007	Control panel glue gasket	1
50	01401427	Electric Box Assy	1
51	42010037	Connector 5EHDV-02P	1
52	42010039S	Connector 5EHDV-07P	1
53	30032023	Main PCB2	1
54	01251015	Junction lid	1
55	01411050	Junction box	1
56	42011103	Terminal Board 2-8	2
57	33010020	Capacitor	1
58	33010020	Capacitor	1
Not Shown	12411904	Indoor Foam Drain Pan	1

# EXPLODED VIEW: EKTC12-2G

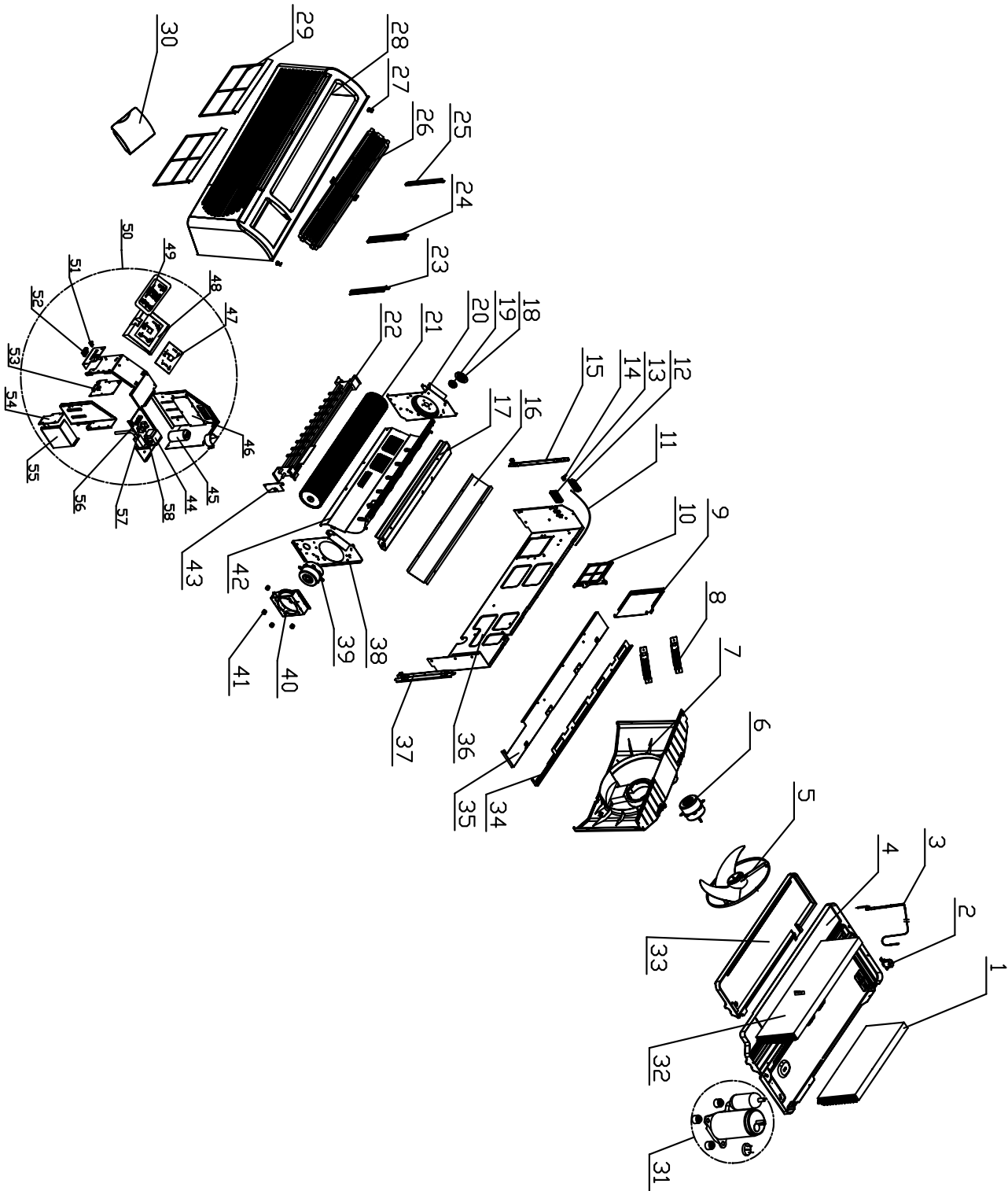

## REPLACEMENT PARTS: EKTC12-2G

NO.	Part Code	Part Description	qty
1	01101809	Condenser Assy	1
2	07100164	Drain water valve	1
3	03001139	Capillary Sub-Assy	1
4	0120102604P	Chassis Sub-assy	1
5	10331004	Axial flow fan	1
6	150110342	Motor (out)	1
7	10371004	Diversion Circle	1
8	01381004	Middle plate	2
9	01441008	Air inlet door Sub-assy	1
10	11121213	Fresh air filter	1
11	02121014	Door thread	1
12	26231154	Cover(UP)	1
13	26231155	Cover(DOWN)	1
14	26231153	Handle	1
15	01701015	Bracket assy(L)	1
16	01471007	Protect net	1
17	02121010P	Cochlea tongue	1
18	02111010	Bearing board	1
19	26151138	Bearing rubber assy	1
20	02121008P	Air hole left board	1
21	10351002	Cross flow fan	1
22	3200102601	PTC Heater	1
23	26111139	Filter board 1	1
24	26111140	Filter board 2	1
25	26111141	Filter board 3	1
26	22411153	Wind gridiron	1
27	02111013	Front panel mtg. clips	2
28	20001457	Front Panel	1
29	11121212	Filter	2
30	20121070	Remote Control Cover	1
31	00101054	Compressor	1
32	01001285	Evaporator Assy	1
33	02121012	Heat insulation plate	1
34	01701009	Up plate bracket	1
35	01251013	Top Cover Plate Sub-Assy	1
36	01231041P	Partition plate	1
37	01701016	Bracket assy(R)	1
38	02121009P	Air hole right board	1
39	1501180205	Motor(IN)	1
40	01701014P	Motor Support Sub-Assy	1
41	76711031	Damping rubber	4
42	0144100905	Air duct sub-assy	1

***Continued on next page....***

## REPLACEMENT PARTS: EKTC12-2G

*Continued from previous page....*

No.	Part Code	Part Description	Qty.
43	02111009	Heater Wiring block board	1
44	43110269	Transformer	1
45	33000017	Capacitor	1
46	30032021	Main PCB1	1
47	30542007	PCB	1
48	20161239	Control panel	1
49	76711007	Control panel glue gasket	1
50	01401429	Electric Box Assy	1
51	42010037	Connector 5EHDV-02P	1
52	42010039S	Connector 5EHDV-07P	1
53	30032023	Main PCB2	1
54	01251015	Junction lid	1
55	01411050	Junction box	1
56	42011103	Terminal Board 2-8	2
57	33010020	Capacitor	1
58	33010026	Capacitor CBB61 2.5uF/450V	1
Not Shown	12411904	Indoor Foam Drain Pan	1

# EXPLODED VIEW: EKTC15-2G

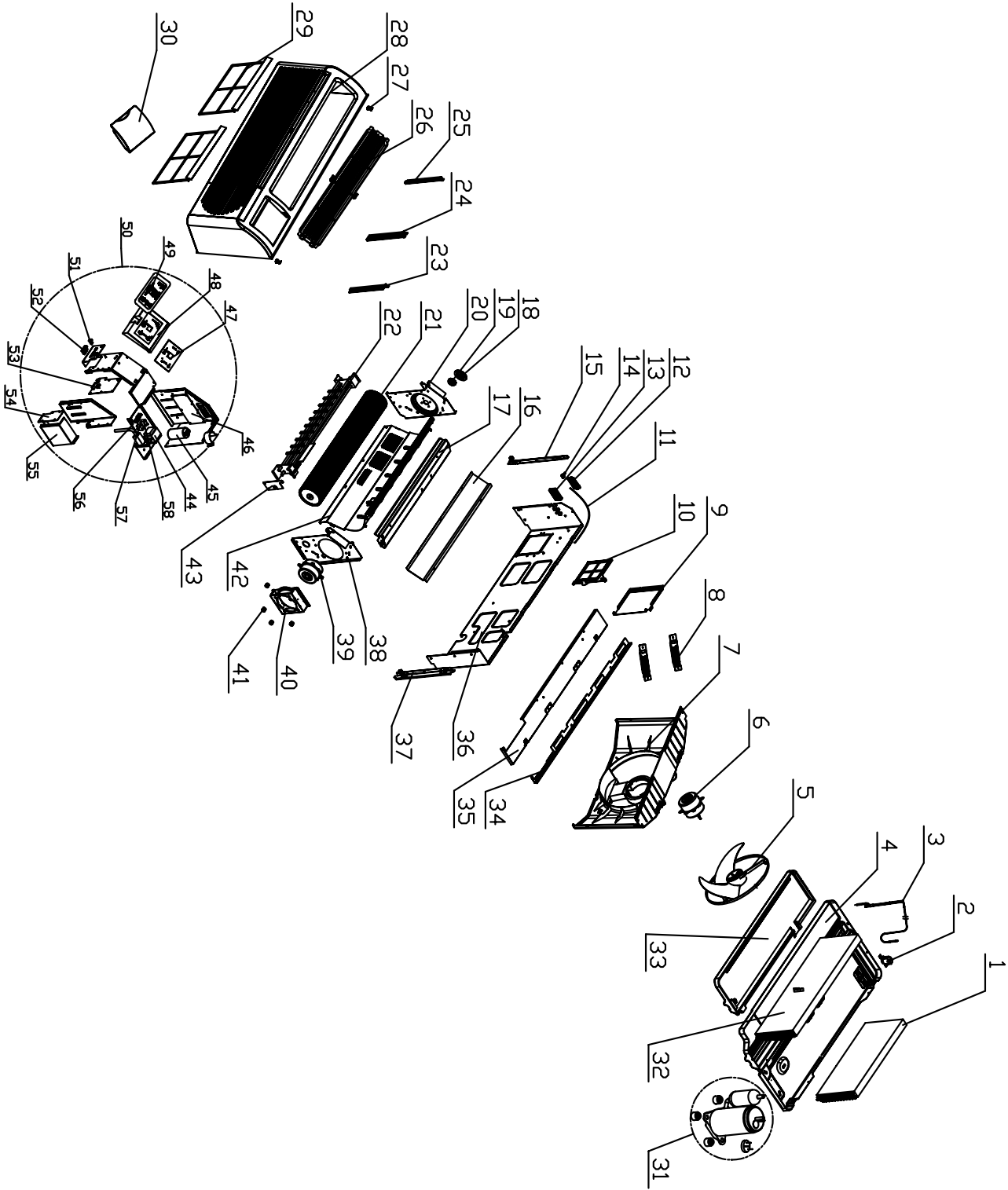

## REPLACEMENT PARTS: EKTC15-2G

NO.	Part Code	Part Description	qty
1	01101191	Condenser Assy	1
2	07100164	Drain water valve	1
3	03001341	Capillary Sub-Assy	1
4	01201026P	Chassis Assy	1
5	10331004	Axial flow fan	1
6	150110342	Motor (out)	1
7	10371004	Diversion Circle	1
8	01381004	Middle plate	2
9	01441008	Air inlet door Sub-assy	1
10	11121213	Fresh air filter	1
11	02121014	Door thread	1
12	26231154	Cover(UP)	1
13	26231155	Cover(DOWN)	1
14	26231153	Handle	1
15	01701015	Bracket assy(L)	1
16	01471007	Protect net	1
17	02121010P	Cochlea tongue	1
18	02111010	Bearing board	1
19	26151138	Bearing rubber assy	1
20	02121008P	Air hole left board	1
21	10351002	Cross flow fan	1
22	3200102601	PTC Heater	1
23	26111139	Filter board 1	1
24	26111140	Filter board 2	1
25	26111141	Filter board 3	1
26	22411153	Wind gridiron	1
27	02111013	Front panel mtg. clips	2
28	20001457	Front Panel	1
29	11121212	Filter	2
30	20121070	Remote Control Cover	1
31	00101091	Compressor and fittings	1
32	01001285	Evaporator Assy	1
33	02121012	Heat insulation plate	1
34	01701009	Up plate bracket	1
35	01251013	Top Cover Plate Sub-Assy	1
36	01231041P	Partition plate	1
37	01701016	Bracket assy(R)	1
38	02121009P	Air hole right board	1
39	1501180205	Motor(IN)	1
40	01701014P	Motor Support Sub-Assy	1
41	76711031	Damping rubber	4
42	0144100905	Air duct sub-assy	1

***Continued on next page....***

## REPLACEMENT PARTS: EKTC15-2G

*Continued from previous page....*

NO.	Part Code	Part Description	qty
42	0144100905	Air duct sub-assy	1
43	02111009	Heater Wiring block board	1
44	43110269	Transformer	1
45	33000017	Capacitor	1
46	30032020	Main PCB1	1
47	30542007	PCB	1
48	20161239	Control panel	1
49	76711007	Control panel glue gasket	1
50	01401914	Electric Box Assy	1
51	42010037	Connector 5EHDV-02P	1
52	42010039S	Connector 5EHDV-07P	1
53	30032023	Main PCB2	1
54	01251015	Junction lid	1
55	01411050	Junction box	1
56	42011103	Terminal Board 2-8	2
57	33010020	Capacitor	1
58	33010026	Capacitor CBB61 2.5uF/450V	1
Not Shown	12411904	Indoor Foam Drain Pan	1

# EXPLODED VIEW: EKTH07-2G

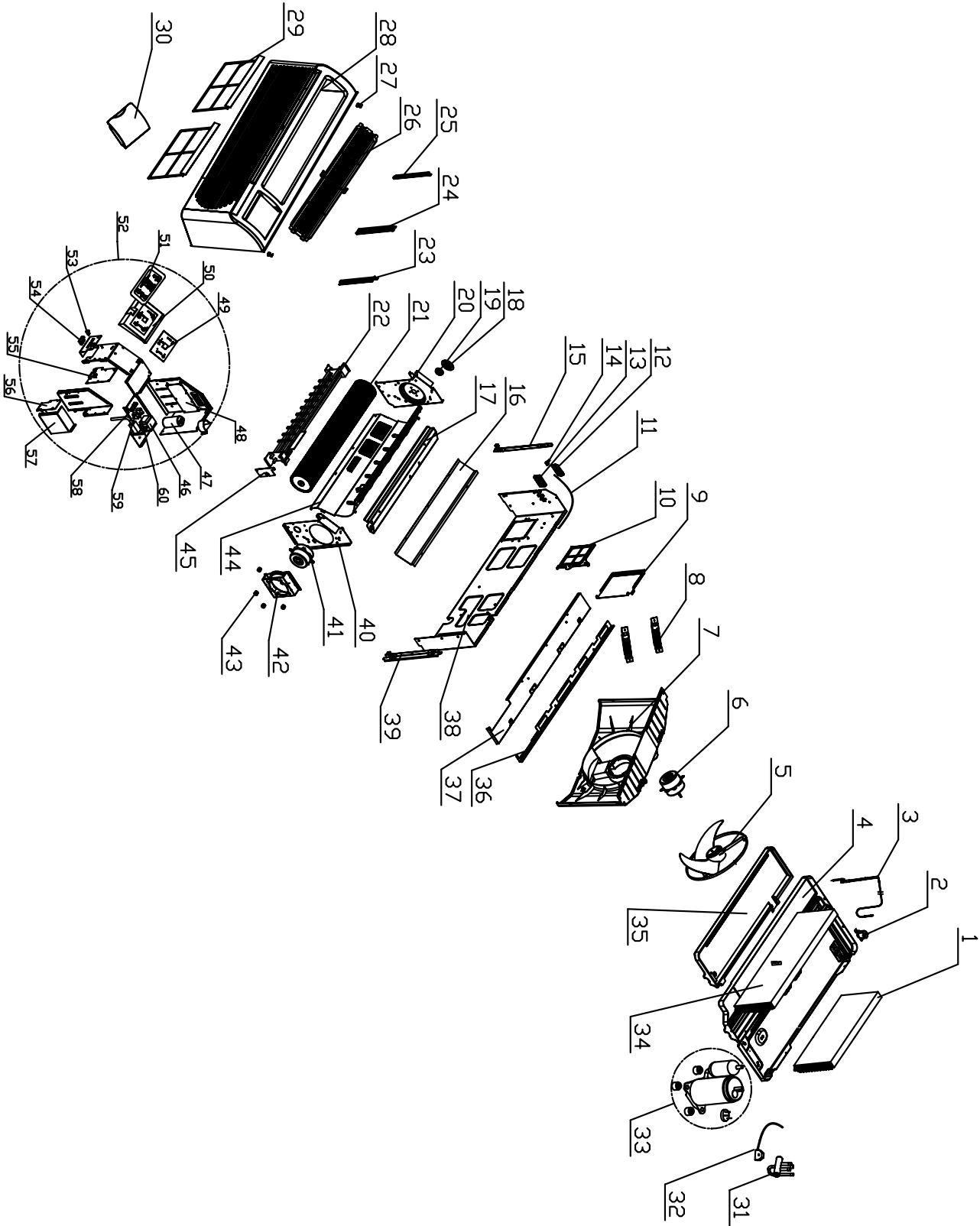

## REPLACEMENT PARTS: EKTH072G

NO.	Part Code	Part Description	qty
1	01101272	Condenser Assy	1
2	07100164	Drain water valve	1
3	03001424	Capillary Sub-Assy	1
4	0120102601P	Chassis Assy	1
5	10331004	Axial flow fan	1
6	150110345	Fan Motor	1
7	10371004	Diversion Circle	1
8	01381004	Middle plate	2
9	01441008	Air inlet door Sub-assy	1
10	11121213	Fresh air filter	1
11	02121014	Door thread	1
12	26231154	Cover(UP)	1
13	26231155	Cover(DOWN)	1
14	26231153	Handle	1
15	01701015	Bracket assy(L)	1
16	01471007	Protect net	1
17	02121010P	Cochlea tongue	1
18	02111010	Bearing board	1
19	26151138	Bearing rubber assy	1
20	02121008P	Air hole left board	1
21	10351002	Cross flow fan	1
22	3200102603	Electric Heater	1
23	26111139	Filter board 1	1
24	26111140	Filter board 2	1
25	26111141	Filter board 3	1
26	22411153	Wind gridiron	1
27	02111013	Front panel mtg. clips	2
28	20001457	Front Panel	1
29	11121212	Filter	2
30	20121070	Remote Control Cover	1
31	03021109	4-way Valve Sub-Assy	1
32	4300040026	4 Way Valve Fittings	1
33	00101060	Compressor and fittings	1
34	01001066	Evaporator Assy	1
35	02121012	Heat insulation plate	1
36	01701009	Up plate bracket	1
37	01251013	Top Cover Plate Sub-Assy	1
38	01231041P	Partition plate	1
39	01701016	Bracket assy(R)	1
40	02121009P	Air hole right board	1
41	1501180204	Fan Motor	1
42	01701014P	Motor Support Sub-Assy	1

***Continued on next page....***

## REPLACEMENT PARTS: EKTH07-2G

*Continued from previous page....*

No.	Part Code	Part Description	Qty.
43	76711031	Damping rubber	4
44	1221013	Air duct sub-assy	1
45	02111009	Heater Wiring block board	1
46	43110269	Transformer	1
47	33010045	Capacitor CBB65 15uF/450V	1
48	30032020	Main PCB1	1
49	30542007	PCB	1
50	20161239	Control panel	1
51	76711007	Control panel glue gasket	1
52	0140125501	Electric Box Assy	1
53	42010037	Connector 5EHDV-02P	1
54	42010039S	Connector 5EHDV-07P	1
55	30032023	Main PCB2	1
56	01251015	Junction lid	1
57	01411050	Junction box	1
58	42011103	Terminal Board 2-8	2
59	33010089	Capacitor CBB611A 1uF/450V	1
60	33010020	Capacitor	1
Not Shown	12411904	Indoor Foam Drain Pan	1

# EXPLODED VIEW: EKTH09-2G

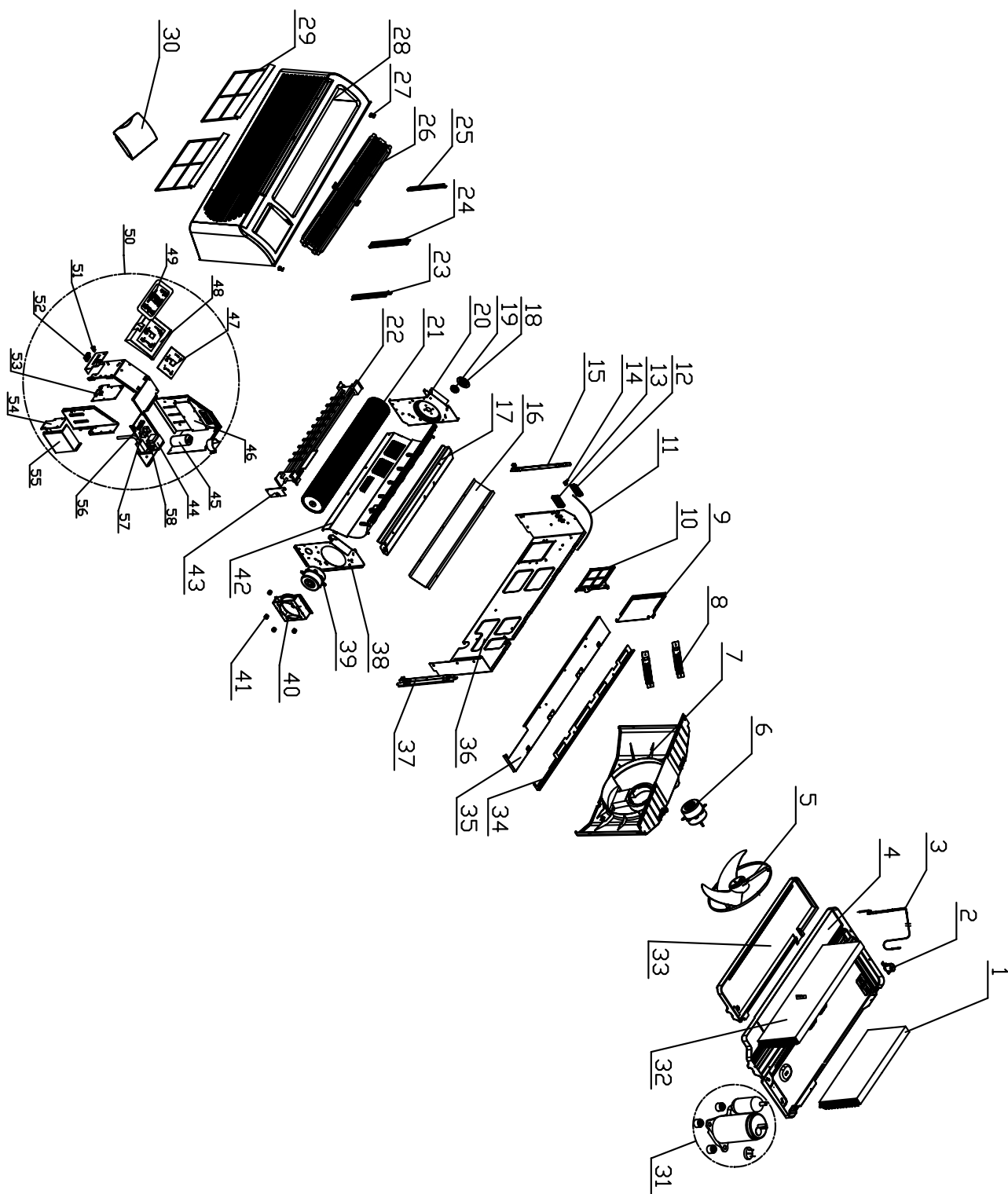

## REPLACEMENT PARTS: EKTH09-2G

NO.	Part Code	Part Description	qty
1	01101809	Condenser Assy	1
2	07100164	Drain water valve	1
3	03001824	Capillary Sub-Assy	1
4	0120102604P	Chassis Sub-assy	1
5	10331004	Axial flow fan	1
6	150110345	Fan Motor	1
7	10371004	Diversion Circle	1
8	01381004	Middle plate	2
9	01441008	Air inlet door Sub-assy	1
10	11121213	Fresh air filter	1
11	02121014	Door thread	1
12	26231154	Cover(UP)	1
13	26231155	Cover(DOWN)	1
14	26231153	Handle	1
15	01701015	Bracket assy(L)	1
16	01471007	Protect net	1
17	02121010P	Cochlea tongue	1
18	02111010	Bearing board	1
19	26151138	Bearing rubber assy	1
20	02121008P	Air hole left board	1
21	10351002	Cross flow fan	1
22	3200102603	Elextric Heater	1
23	26111139	Filter board 1	1
24	26111140	Filter board 2	1
25	26111141	Filter board 3	1
26	22411153	Wind gridiron	1
27	02111013	Front panel mtg. clips	2
28	20001457	Front Panel	1
29	11121212	Filter	2
30	20121070	Remote Control Cover	1
31	00101052	Compressor	1
32	01001284	Evaporator Assy	1
33	02121012	Heat insulation plate	1
34	01701009	Up plate bracket	1
35	01251013	Top Cover Plate Sub-Assy	1
36	01231041P	Partition plate	1
37	01701016	Bracket assy(R)	1
38	02121009P	Air hole right board	1
39	1501180201	Motor(IN)	1
40	01701014P	Motor Support Sub-Assy	1
41	76711031	Damping rubber	4
42	0122101101	Air duct sub-assy	1

***Continued on next page....***

## REPLACEMENT PARTS: EKTH09-2G

*Continued from previous page....*

No.	Part Code	Part Description	Qty.
43	02111009	Heater Wiring block board	1
44	43110269	Transformer	1
45	33010045	Capacitor CBB65 15uF/450V	1
46	30032020	Main PCB1	1
47	30542007	PCB	1
48	20161239	Control panel	1
49	76711007	Control panel glue gasket	1
50	01401332	Electric Box Assy	1
51	42010037	Connector 5EHDV-02P	1
52	42010039S	Connector 5EHDV-07P	1
53	30032023	Main PCB2	1
54	01251015	Junction lid	1
55	01411050	Junction box	1
56	42011103	Terminal Board 2-8	2
57	33010020	Capacitor	1
58	33010020	Capacitor	1
Not Shown	12411904	Indoor Foam Drain Pan	1

# EXPLODED VIEW: EKTH12-2G

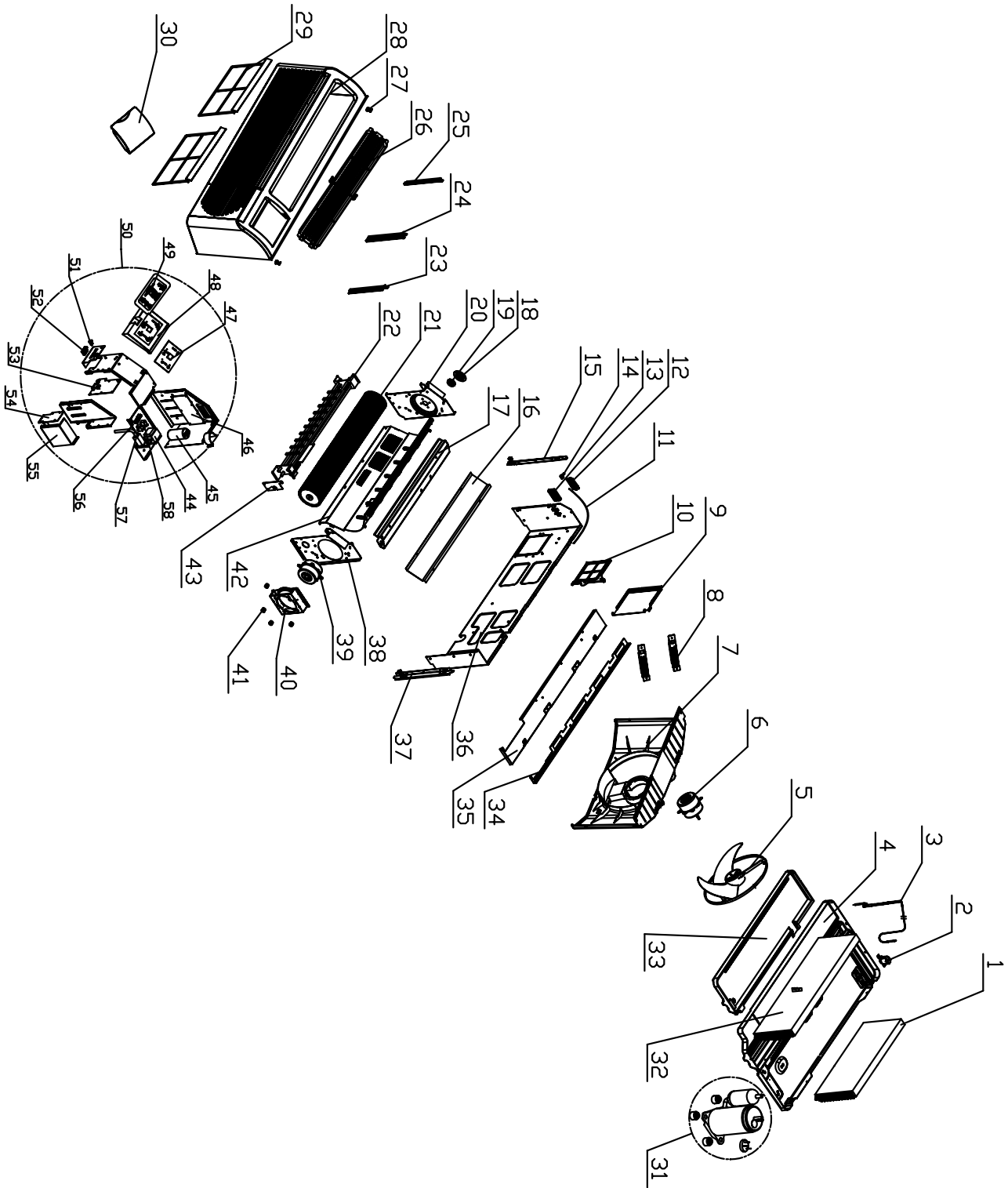

## REPLACEMENT PARTS: EKTH12-2G

NO.	Part Code	Part Description	qty
1	01101809	Condenser Assy	1
2	07100164	Drain water valve	1
3	03001139	Capillary Sub-Assy	1
4	0120102604P	Chassis Sub-assy	1
5	10331004	Axial flow fan	1
6	150110342	Motor (out)	1
7	10371004	Diversion Circle	1
8	01381004	Middle plate	2
9	01441008	Air inlet door Sub-assy	1
10	11121213	Fresh air filter	1
11	02121014	Door thread	1
12	26231154	Cover(UP)	1
13	26231155	Cover(DOWN)	1
14	26231153	Handle	1
15	01701015	Bracket assy(L)	1
16	01471007	Protect net	1
17	02121010P	Cochlea tongue	1
18	02111010	Bearing board	1
19	26151138	Bearing rubber assy	1
20	02121008P	Air hole left board	1
21	10351002	Cross flow fan	1
22	3200102601	PTC Heater	1
23	26111139	Filter board 1	1
24	26111140	Filter board 2	1
25	26111141	Filter board 3	1
26	22411153	Wind gridiron	1
27	02111013	Front panel mtg. clips	2
28	20001457	Front Panel	1
29	11121212	Filter	2
30	20121070	Remote Control Cover	1
31	00101054	Compressor	1
32	01001285	Evaporator Assy	1
33	02121012	Heat insulation plate	1
34	01701009	Up plate bracket	1
35	01251013	Top Cover Plate Sub-Assy	1
36	01231041P	Partition plate	1
37	01701016	Bracket assy(R)	1
38	02121009P	Air hole right board	1
39	1501180205	Motor(IN)	1
40	01701014P	Motor Support Sub-Assy	1
41	76711031	Damping rubber	4

***Continued on next page....***

## REPLACEMENT PARTS: EKTH12-2G

*Continued from previous page....*

No.	Part Code	Part Description	Qty.
42	0144100905	Air duct sub-assy	1
43	02111009	Heater Wiring block board	1
44	43110269	Transformer	1
45	33000017	Capacitor	1
46	30032020	Main PCB1	1
47	30542007	PCB	1
48	20161239	Control panel	1
49	76711007	Control panel glue gasket	1
50	01401431	Electric Box Assy	1
51	42010037	Connector 5EHDV-02P	1
52	42010039S	Connector 5EHDV-07P	1
53	30032023	Main PCB2	1
54	01251015	Junction lid	1
55	01411050	Junction box	1
56	42011103	Terminal Board 2-8	2
57	33010020	Capacitor	1
58	33010026	Capacitor CBB61 2.5uF/450V	1
Not Shown	12411904	Indoor Foam Drain Pan	1

# EXPLODED VIEW: EKTH15-2G

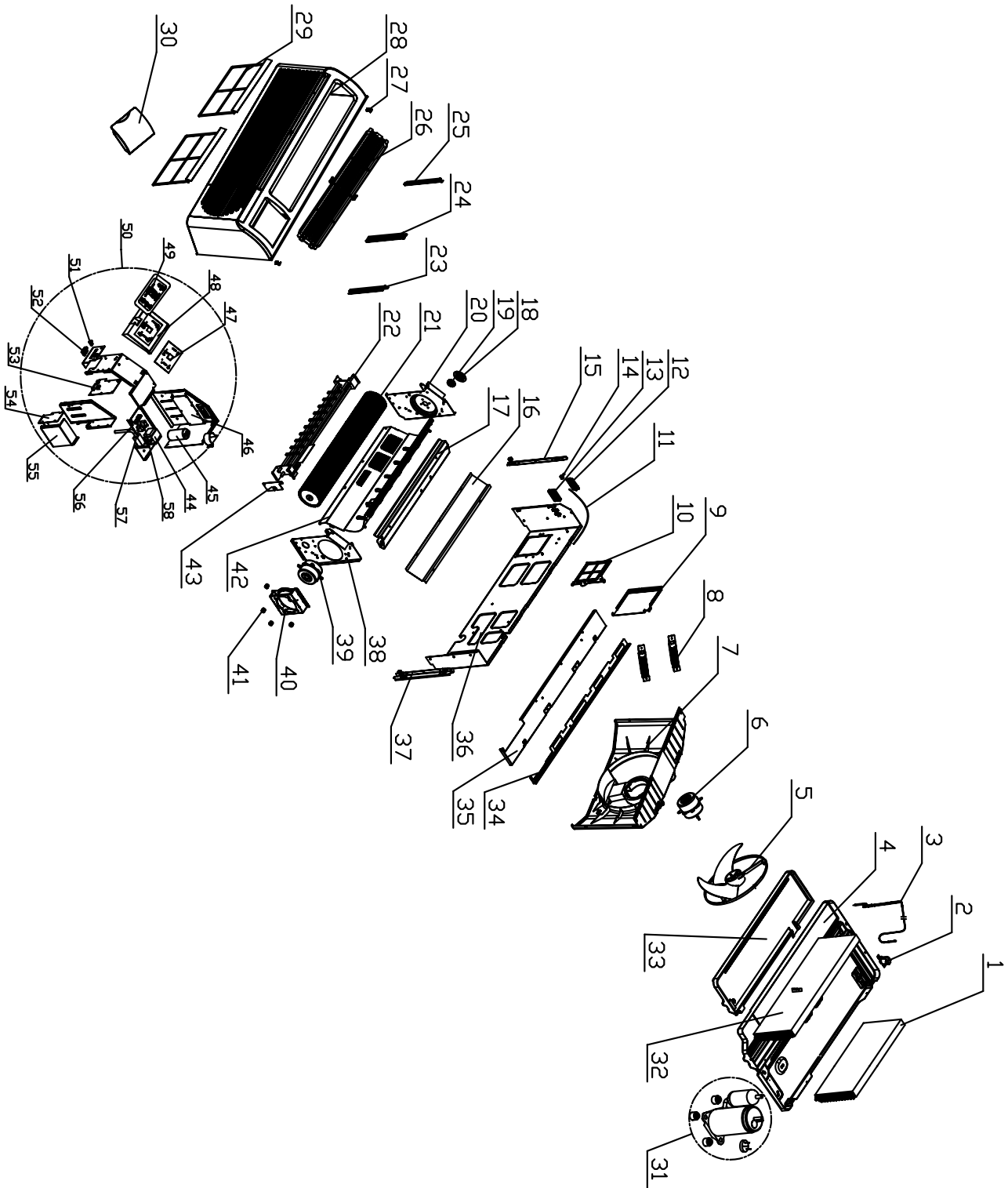

## REPLACEMENT PARTS: EKTH15-2G

NO.	Part Code	Part Description	qty
1	01101191	Condenser Assy	1
2	07100164	Drain water valve	1
3	03001366	Capillary Sub-Assy	1
4	01201026P	Chassis Assy	1
5	10331004	Axial flow fan	1
6	150110342	Motor (out)	1
7	10371004	Diversion Circle	1
8	01381004	Middle plate	2
9	01441008	Air inlet door Sub-assy	1
10	11121213	Fresh air filter	1
11	02121014	Door thread	1
12	26231154	Cover(UP)	1
13	26231155	Cover(DOWN)	1
14	26231153	Handle	1
15	01701015	Bracket assy(L)	1
16	01471007	Protect net	1
17	02121010P	Cochlea tongue	1
18	02111010	Bearing board	1
19	26151138	Bearing rubber assy	1
20	02121008P	Air hole left board	1
21	10351002	Cross flow fan	1
22	3200102601	PTC Heater	1
23	26111139	Filter board 1	1
24	26111140	Filter board 2	1
25	26111141	Filter board 3	1
26	22411153	Wind gridiron	1
27	02111013	Front panel mtg. clips	2
28	20001457	Front Panel	1
29	11121212	Filter	2
30	20121070	Remote Control Cover	1
31	00101091	Compressor and fittings	1
32	01001285	Evaporator Assy	1
33	02121012	Heat insulation plate	1
34	01701009	Up plate bracket	1
35	01251013	Top Cover Plate Sub-Assy	1
36	01231041P	Partition plate	1
37	01701016	Bracket assy(R)	1
38	02121009P	Air hole right board	1
39	1501180205	Motor(IN)	1
40	01701014P	Motor Support Sub-Assy	1
41	76711031	Damping rubber	4

***Continued on next page....***

## REPLACEMENT PARTS: EKTH15-2G

*Continued from previous page....*

No.	Part Code	Part Description	Qty.
42	0144100905	Air duct sub-assy	1
43	02111009	Heater Wiring block board	1
44	43110269	Transformer	1
45	33000017	Capacitor	1
46	30032020	Main PCB1	1
47	30542007	PCB	1
48	20161239	Control panel	1
49	76711007	Control panel glue gasket	1
50	01401914	Electric Box Assy	1
51	42010037	Connector 5EHDV-02P	1
52	42010039S	Connector 5EHDV-07P	1
53	30032023	Main PCB2	1
54	01251015	Junction lid	1
55	01411050	Junction box	1
56	42011103	Terminal Board 2-8	2
57	33010020	Capacitor	1
58	33010026	Capacitor CBB61 2.5uF/450V	1
Not Shown	12411904	Indoor Foam Drain Pan	1

Due to ongoing product improvements, specifications and dimensions are subject to change and correction without notice or incurring obligations. Determining the application and suitability for use of any product is the responsibility of the installer. Additionally, the installer is responsible for verifying dimensional data on the actual product prior to beginning any installation preparations.

Incentive and rebate programs have precise requirements as to product performance and certification. All products meet applicable regulations in effect on date of manufacture; however, certifications are not necessarily granted for the life of a product. Therefore, it is the responsibility of the applicant to determine whether a specific model qualifies for these incentive/rebate programs.

*Comfort-Cire*® **Century**

1900 Wellworth Ave., Jackson, MI 49203 • Ph. 517-787-2100 • [www.marsdelivers.com](http://www.marsdelivers.com)

