

This Owner's Manual is provided and hosted by [Appliance Factory Parts](#).



COMFORT-AIRE AHCG90A-YL Owner's Manual

[Shop genuine replacement parts for COMFORT-AIRE
AHCG90A-YL](#)



[Find Your COMFORT-AIRE HVAC Parts - Select From 1486 Models](#)

----- Manual continues below -----

HEAT CONTROLLER, INC.

AHCG

Parts List
29-March-2012



This parts list is current as of the above revision date.

Form Number: 92-42810-AHCG

Table of Contents

Model Explanation	Page 3
Parts Numbers	
Panels - Miscellaneous	Page 4
Blower Group 090	Page 5
Blower Group 120	Page 6
Blower Group 180-240	Page 7
Coil Parts	Page 8
Drawings/Photographs	
Exploded View 090-120	Page 9
Exploded View 180-240	Page 10
Notes	Page 11

MODEL NUMBER EXPLANATION

A	H	C	G	1	2	0	A	-	H	K
1			2			3				

- (1) **SERIES**
- (2) **COOLING CAPACITY**
 090 = 7.5 Tons
 120 = 10 Tons
 180 = 15.0 Tons
 240 = 20.0 Tons
- (3) **OPTIONS**

SERIAL NUMBER EXPLANATION

0	6	0	F	0	1	9	2	9	9	9	9	9
1		2	3		4		5					

- 1 DRIVE COMPONENTS**
- 2 PRODUCTION LOCATION**
F = Ft. Smith, AR
- 3 WEEK OF PRODUCTION**
- 4 YEAR OF PRODUCTION**
- 5 PRODUCTION NUMBER**

No.	Notes	MODEL COOLING CAPACITY VARIATIONS	AHCG 090 ALL	AHCG 120 ALL
PANELS, MISCELLANEOUS PARTS				
1		Floor Pan w/Insulation	AS-90440-01C	AS-90440-01C
2		Center Post w/Insulation (2)	AS-90440-03C	AS-90440-03C
3		Corner Post w/Insulation (2)	AS-90440-04C	AS-90440-04C
4		Duct Flange Outlet	AE-76847-01	AE-76847-01
5		Drain Pan	See Coil Group	
6		Access Panel w/Insulation (2)	AS-90440-10C	AS-90440-10C
7		Access Panel w/Insulation (2)	AS-90440-11C	AS-90440-11C
8		Inlet Cap w/ Insulation (2)	AS-90440-12C	AS-90440-12C
9a		Top Pan Insulation Assembly	AS-78097-01C	AS-78097-01C
9b		Top Pan Insulation Assembly	AS-78096-01C	AS-78096-01C
20		Top Filter Channel	AE-90373-01	AE-90373-01
22		Filter Rack	AS-90459-01	AS-90459-01
23		Hitch Pin Clip (2)	63-20878-01	63-20878-01
		Filter Block-Off	AE-90379-01	AE-90379-01
24		Filter Retainer Plate	AE-90377-01	AE-90377-01
25		Filter - Disposable (4)	54-17531-10	54-17531-10
35		Junction Box	AS-90472-01	AS-90472-01

No.	Notes	MODEL COOLING CAPACITY VARIATIONS	AHCG 180 ALL	AHCG 240 ALL
PANELS, MISCELLANEOUS PARTS				
1a		Floor Pan w/ Insulation - Left	AS-90389-02C	AS-90389-02C
1b		Floor Pan w/ Insulation - Right	AS-90389-01C	AS-90389-01C
2		Center Post w/ Insulation (2)	AS-90389-04C	AS-90389-04C
3		Corner Post w/ Insulation (2)	AS-90389-05C	AS-90389-05C
4		Duct Flange Outlet	AE-90196-01	AE-90196-01
5		Drain Pan	See Coil Group	
6		Access Panel w/ Insulation (4)	AS-90389-12C	AS-90389-12C
8		Inlet Cap w/ Insulation (2)	AS-90389-13C	AS-90389-13C
10		Top Rail - Right	AS-90389-07C	AS-90389-07C
11		Top Rail - Left	AS-90389-08C	AS-90389-08C
12		Top Pan - Front	AS-90389-09C	AS-90389-09C
13		Top Pan - Rear	AS-90389-10C	AS-90389-10C
14		Top Pan - Center	AS-90389-11C	AS-90389-11C
15		Motor Mounting Plate	AE-90199-01	AE-90199-01
16		Motor Plate - Bottom	AS-71955-01	AS-71955-02
17		Motor Plate - Top	AE-90211-01	AE-90211-01
20		Top Filter Channel	AS-90416-01	AS-90416-01
21		Bottom Filter Channel	AE-90206-01	AE-90206-01
22		Center Filter Support (2)	AE-90208-01	AE-90208-01
23		Hitch Pin Clip (2)	63-20878-01	63-20878-01
24		Filter Retainer Plate	AE-90209-01	AE-90209-01
25		Filter Disposable (6)	54-17531-06	54-17531-06

No.	Notes	MODEL COOLING CAPACITY VARIATIONS	AHCG 090 A-HK	AHCG 090 A-YK	AHCG 090 A-YL
BLOWER GROUP					
26	Stk	Blower Assembly (Includes all items listed below except Blower Plate)	AS-90451-01	AS-90444-05	AS-90444-06
27		Blower Housing	AS-77539-02	AS-77539-02	AS-77539-02
28		Blower Plate w/Insulation	AS-90440-02C	AS-90440-02C	AS-90440-02C
29	Stk	Bearing w/cushion (2)	70-41911-01	70-41911-01	70-41911-01
	Stk	Blower Wheel	70-41512-01	70-41512-01	70-41512-01
		Cut Off	AE-72264-03	AE-72264-03	AE-72264-03
30	Stk	Shaft-Blower	70-41900-02	70-41900-02	70-41900-02
		Motor Support	AS-70423-05	AS-70423-05	AS-70423-05
31	Stk	Sheave - Fixed	71-41901-30	71-41901-30	71-41901-30
		Key Shaft	94-42551-08	94-42551-08	94-42551-08
32	Stk	Belt	71-17033-49	71-17033-53	71-17033-53
33		Blower Support (2)	AE-90369-01	AE-90369-01	AE-90369-01
36	Stk	Blower Motor	51-40638-01	51-42177-09	51-42177-10
	Stk	Sheave - Variable	71-40427-41	71-40427-25	71-42538-05
		Motor Mounting Bracket	AE-72344-01	AE-72344-01	AE-72344-01
38		Motor Adjustment Piece	AE-70411-01	AE-70411-01	AE-70411-01
39		Bearing Frame Assembly - Tri-Arm	70-41723-02	70-41723-02	70-41723-02

No.	Notes	MODEL COOLING CAPACITY VARIATIONS	AHCG 090 A-YM	AHCG 090 A-ZK	AHCG 090 A-ZL	AHCG 090 A-ZM
BLOWER GROUP						
26	Stk	Blower Assembly (Includes all items listed below except Blower Plate)	AS-90444-07	AS-90444-02	AS-90444-03	AS-90444-04
27		Blower Housing	AS-77539-02	AS-77539-02	AS-77539-02	AS-77539-02
28		Blower Plate	AS-90440-02C	AS-90440-02C	AS-90440-02C	AS-90440-02C
29	Stk	Bearing (2)	70-41911-01	70-41911-01	70-41911-01	70-41911-01
	Stk	Blower Wheel	70-41512-01	70-41512-01	70-41512-01	70-41512-01
		Cut Off	AE-72264-03	AE-72264-03	AE-72264-03	AE-72264-03
30	Stk	Shaft-Blower	70-41900-02	70-41900-02	70-41900-02	70-41900-02
		Motor Support	AS-70423-05	AS-70423-05	AS-70423-05	AS-70423-05
31	Stk	Sheave - Fixed	71-41901-30	71-41901-30	71-41901-30	71-41901-30
		Key Shaft	94-42551-08	94-42551-08	94-42551-08	94-42551-08
32	Stk	Belt	71-17033-55	71-17033-53	71-17033-53	71-17033-55
33		Blower Support (2)	AE-90369-01	AE-90369-01	AE-90369-01	AE-90369-01
36	Stk	Blower Motor	51-42177-10	51-42368-02	51-42369-02	51-42369-02
	Stk	Sheave - Variable	71-40427-54	71-40427-25	71-42538-05	71-40427-54
		Motor Mounting Bracket	AE-72344-01	AE-72344-01	AE-72344-01	AE-72344-01
38		Motor Adjustment Piece	AE-70411-01	AE-70411-01	AE-70411-01	AE-70411-01
39		Bearing Frame Assembly - Tri-Arm	70-41723-02	70-41723-02	70-41723-02	70-41723-02

No.	Notes	MODEL NOMINAL CAPACITY DRIVE PACKAGE	AHCG 120 A-HK	AHCG 120 A-YK	AHCG 120 A-YL
BLOWER GROUP					
26	Stk	Blower Assembly (Includes all items listed below except Blower Plate)	AS-90451-02	AS-90444-12	AS-90444-13
27		Blower Housing	AS-77539-02	AS-77539-02	AS-77539-02
28		Blower Plate w/Insulation	AS-90440-02C	AS-90440-02C	AS-90440-02C
29	Stk	Bearing	70-41911-01	70-41911-01	70-41911-01
	Stk	Blower Wheel	70-41512-01	70-41512-01	70-41512-01
		Cut Off	AE-72264-03	AE-72264-03	AE-72264-03
30	Stk	Shaft-Blower	70-41900-02	70-41900-02	70-41900-02
		Motor Support	AS-70423-05	AS-70423-05	AS-70423-05
31	Stk	Sheave - Fixed	71-41901-29	71-41901-30	71-41901-30
		Key Shaft	94-42551-08	94-42551-08	94-42551-08
32	Stk	Belt	71-17033-48	71-17033-54	71-17033-54
33		Blower Support (2)	AE-90369-01	AE-90369-01	AE-90369-01
36	Stk	Blower Motor	51-41949-01	51-42177-10	51-42178-09
	Stk	Sheave - Variable	71-40427-41	71-40427-43	71-40427-19
		Motor Mounting Bracket	AE-72344-01	AE-72344-01	AE-72344-01
38		Motor Adjustment Piece	AE-70411-01	AE-70411-01	AE-70411-01
39		Bearing Frame Assembly - Tri-Arm	70-41723-02	70-41723-02	70-41723-02

No.	Notes	MODEL COOLING CAPACITY VARIATIONS	AHCG 120 A-YM	AHCG 120 A-ZK	AHCG 120 A-ZL	AHCG 120 A-ZM
BLOWER GROUP						
26	Stk	Blower Assembly (Includes all items listed below except Blower Plate)	AS-90444-14	AS-90444-09	AS-90444-10	AS-90444-11
27		Blower Housing	AS-77539-02	AS-77539-02	AS-77539-02	AS-77539-02
28		Blower Plate w/Insulation	AS-90440-02C	AS-90440-02C	AS-90440-02C	AS-90440-02C
29	Stk	Bearing (2)	70-41911-01	70-41911-01	70-41911-01	70-41911-01
	Stk	Blower Wheel	70-41512-01	70-41512-01	70-41512-01	70-41512-01
		Cut Off	AE-72264-03	AE-72264-03	AE-72264-03	AE-72264-03
30	Stk	Shaft-Blower	70-41900-02	70-41900-02	70-41900-02	70-41900-02
		Motor Support	AS-70423-05	AS-70423-05	AS-70423-05	AS-70423-05
31	Stk	Sheave - Fixed	71-41901-30	71-41901-30	71-41901-30	71-41901-30
		Key Shaft	94-42551-08	94-42551-08	94-42551-08	94-42551-08
32	Stk	Belt	71-17033-55	71-17033-54	71-17033-54	71-17033-55
33		Blower Support (2)	AE-90369-01	AE-90369-01	AE-90369-01	AE-90369-01
36	Stk	Blower Motor	51-42177-08	51-42369-02	51-42370-02	51-42371-01
	Stk	Sheave - Variable	71-40427-23	71-40427-43	71-40427-19	71-40427-23
		Motor Mounting Bracket	AE-72344-01	AE-72344-01	AE-72344-01	AE-72344-01
38		Motor Adjustment Piece	AE-70411-01	AE-70411-01	AE-70411-01	AE-70411-01
39		Bearing Frame Assembly - Tri-Arm	70-41723-02	70-41723-02	70-41723-02	70-41723-02

No.	Notes	MODEL NOMINAL CAPACITY DRIVE PACKAGE	AHCG 180 A-YK	AHCG 180 A-YL	AHCG 180 A-ZK	AHCG 180 A-ZL	AHCG 180 A-ZM
BLOWER GROUP							
26	Stk	Blower Assembly (Does not include Blower Plate, Belt, Junction Box, Motor and Variable Sheave)	AS-90973-01	AS-90973-01	AS-90973-01	AS-90973-01	AS-90973-02
27		Blower Housing	AS-90971-01	AS-90971-01	AS-90971-01	AS-90971-01	AS-90971-01
28		Blower Plate	AE-90857-01	AE-90857-01	AE-90857-01	AE-90857-01	AE-90857-01
29	Stk	Bearing (2)	70-41854-02	70-41854-02	70-41854-02	70-41854-02	70-41854-02
		Bearing Bracket (2)	70-42284-04	70-42284-04	70-42284-04	70-42284-04	70-42284-04
	Stk	Blower Wheel	70-42682-02	70-42682-02	70-42682-02	70-42682-02	70-42682-02
30		Shaft - Blower	70-41900-06	70-41900-06	70-41900-06	70-41900-06	70-41900-06
31	Stk	Sheave - Fixed	71-41901-11	71-41901-11	71-41901-11	71-41901-11	71-41901-13
		Key - Shaft (2)	AE-72654-01	AE-72654-01	AE-72654-01	AE-72654-01	AE-72654-01
32	Stk	Belt	71-40438-24	71-40438-24	71-40438-24	71-40438-24	71-40438-17
33		Blower Support (2)	AE-90858-01	AE-90858-01	AE-90858-01	AE-90858-01	AE-90858-01
35		Junction Box Assembly	AS-90472-01	AS-90472-01	AS-90472-01	AS-90472-01	AS-90472-01
36	Stk	Motor	51-42178-09	51-42177-08	51-42370-02	51-42371-02	51-42177-13
37	Stk	Sheave - Variable	71-42538-02	71-40427-17	71-42538-02	71-40427-17	71-42538-03

No.	Notes	MODEL NOMINAL CAPACITY DRIVE PACKAGE	AHCG 240 A-YK	AHCG 240 A-YL	AHCG 240 A-ZK	AHCG 240 A-ZL	AHCG 240 A-ZM
BLOWER GROUP							
26	Stk	Blower Assembly (Does not include Blower Plate, Belt, Junction Box, Motor and Variable Sheave)	AS-90974-01	AS-90974-02	AS-90974-01	AS-90974-02	AS-90974-03
27		Blower Housing	AS-90972-01	AS-90972-01	AS-90972-01	AS-90972-01	AS-90972-01
28		Blower Plate	AE-90857-01	AE-90857-01	AE-90857-01	AE-90857-01	AE-90857-01
29	Stk	Bearing (2)	70-41854-02	70-41854-02	70-41854-02	70-41854-02	70-41854-02
		Bearing Bracket (2)	70-42284-04	70-42284-04	70-42284-04	70-42284-04	70-42284-04
	Stk	Blower Wheel	70-42682-01	70-42682-01	70-42682-01	70-42682-01	70-42682-01
30	Stk	Shaft - Blower	70-41900-05	70-41900-05	70-41900-05	70-41900-05	70-41900-05
31	Stk	Sheave - Fixed	71-41901-11	71-41901-22	71-41901-11	71-41901-22	71-41901-19
		Key - Shaft (2)	AE-72654-01	AE-72654-01	AE-72654-01	AE-72654-01	AE-72654-01
32	Stk	Belt	71-40438-22	71-41764-05	71-40438-22	71-41764-05	71-41764-06
33		Blower Support (2)	AE-90858-01	AE-90858-01	AE-90858-01	AE-90858-01	AE-90858-01
35		Junction Box Assembly	AS-90472-01	AS-90472-01	AS-90472-01	AS-90472-01	AS-90472-01
36	Stk	Motor	51-42574-01	51-42178-12	51-42177-13	51-42177-06	51-42177-06
37	Stk	Sheave - Variable	71-40427-06	71-40428-34	71-40427-06	71-40428-34	71-40428-34

No.	Notes	MODEL COOLING CAPACITY VARIATIONS	AHCG 090 ALL	AHCG 120 ALL
COIL GROUP				
5	Stk	Drain Pan	AS-90442-01C	AS-90442-01C
18	Stk	Evaporator Coil w/TXV	AS-90902-05	AS-90902-06
19	Stk	TXV w/Distributor (2)	61-42662-07	61-42662-08
		Drip Rail	AE-90471-01	AE-90471-01

No.	Notes	MODEL COOLING CAPACITY VARIATIONS	AHCG 180 ALL	AHCG 240 ALL
COIL GROUP				
5	Stk	Drain Pan	AS-90402-01C	AS-90402-01C
18	Stk	Evaporator Coil w/ TX Valve	AS-90902-07	AS-90902-08
19	Stk	TX Valve Assembly w/ Dist (2)	61-42662-09	61-42662-10

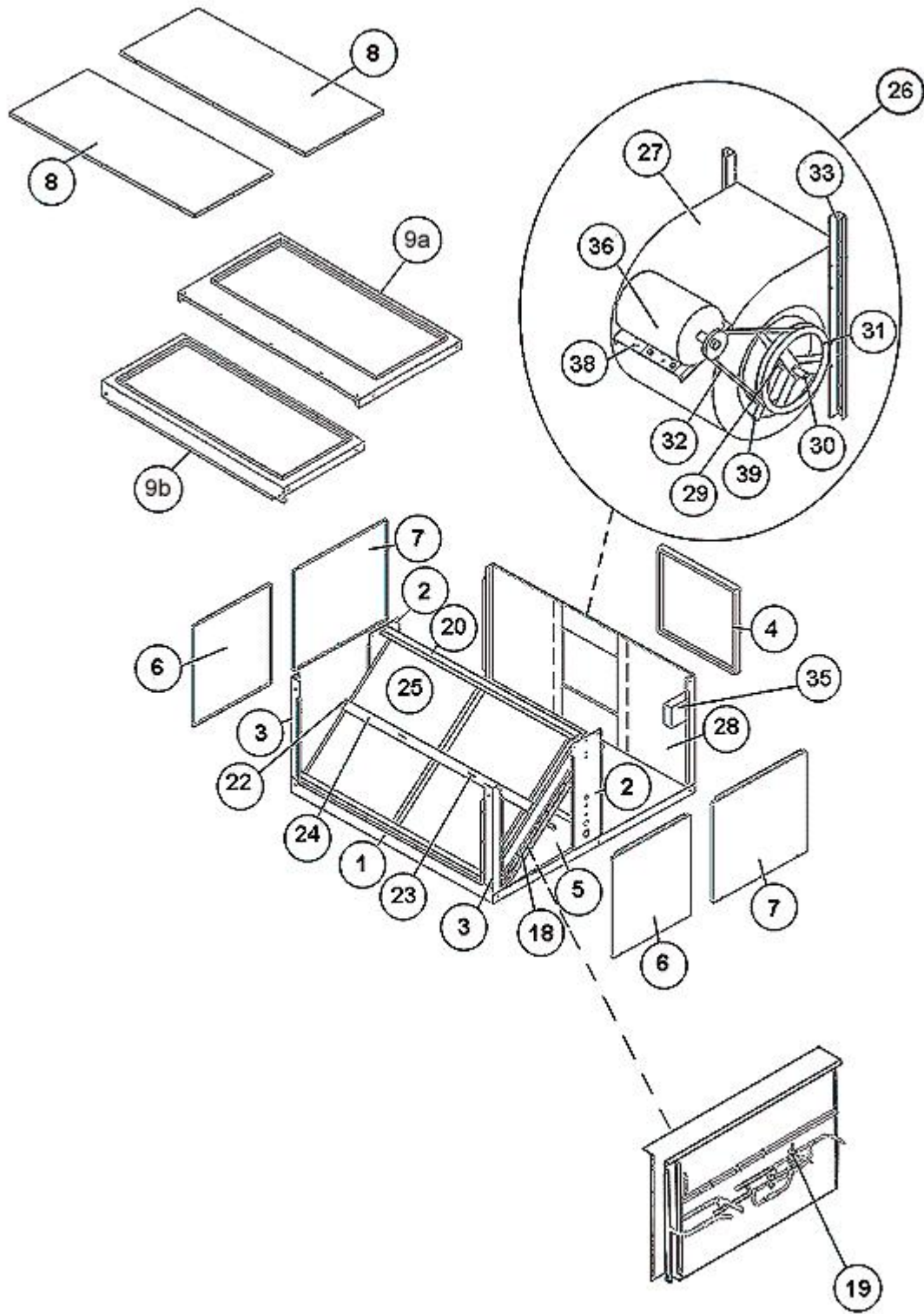

Exploded View 090-120

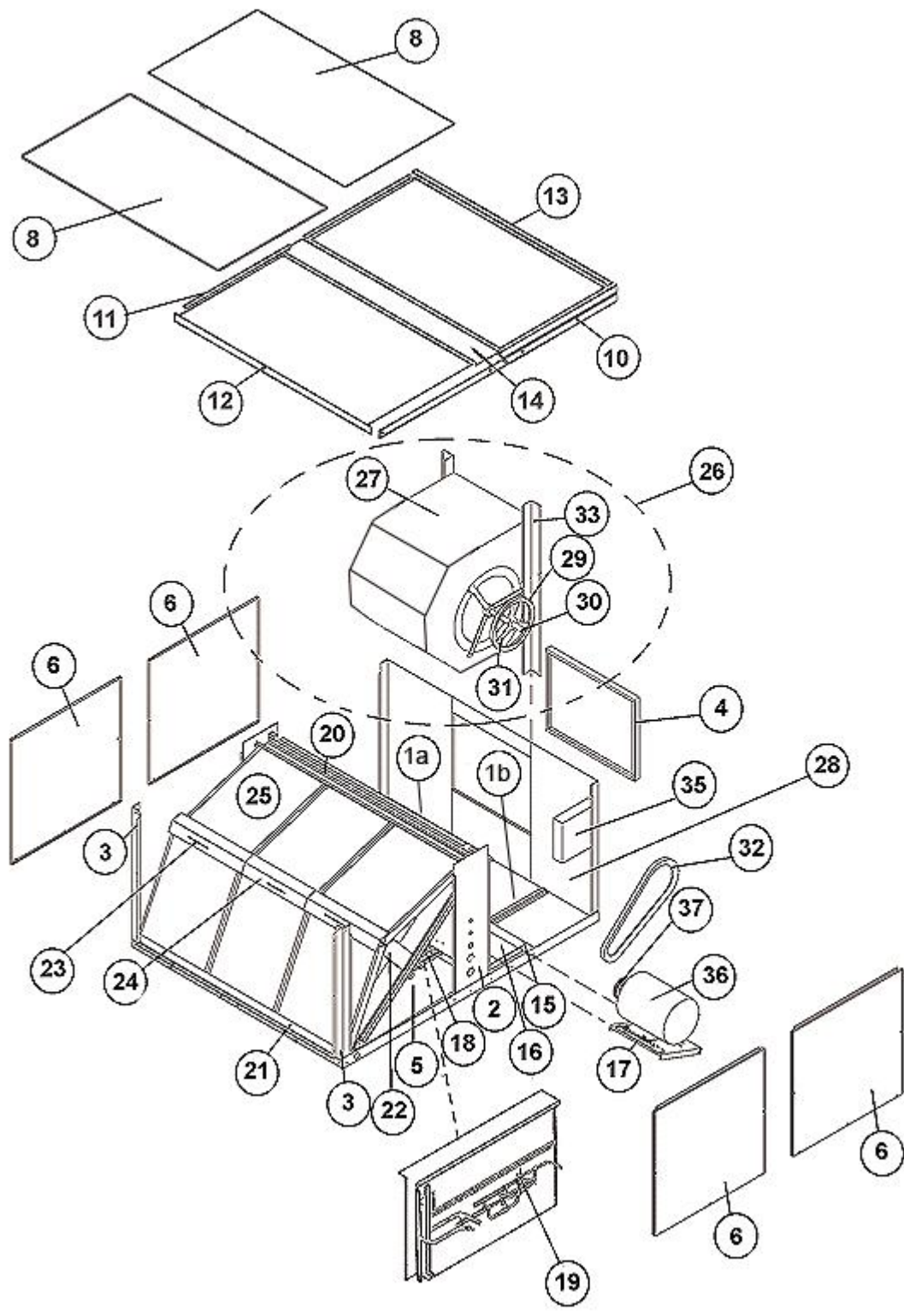

Exploded View 180-240

NOTES

Stk It is recommended that stock be maintained for this part.
N/A Not Applicable