

This Owner's Manual is provided and hosted by [Appliance Factory Parts](#).



COMFORT-AIRE GLDB90E-5A Owner's Manual

[Shop genuine replacement parts for COMFORT-AIRE
GLDB90E-5A](#)



[Find Your COMFORT-AIRE HVAC Parts - Select From 1486 Models](#)

----- Manual continues below -----

GLDB-A

HEAT CONTROLLER, INC.

Parts List
18-October-2011



This parts list is current as of the above revision date.

Form Number: 92-42810-GLDB-A

Table of Contents

Model Explanation	Page 3
Parts Numbers	
Panels - Miscellaneous (1)	Page 4
Panels - Miscellaneous (2)	Page 5
Electrical Group	Page 6
Blower Group	Page 6
Heat Exchanger-Burner Group	Page 7
Gas Controls	Page 8
Orifice Selection Chart	Page 9
Drawings/Photographs	
Exploded View	Page 10
Horizontal Installation Parts	Page 11
Blower Assembly	Page 12
Burner Assembly	Page 13
Notes	Page 14

MODEL NUMBER EXPLANATION

G	L	D	B	-	4	5	E	3	A
1	2	3	4			5		6	7

- (1) **GAS**
- (2) **95% EFFICIENCY**
- (3) **DOWNFLOW/HORIZONTAL CONDENSING**
- (4) **PLACEHOLDER**
- (5) **HEATING INPUT DESIGNATION**
 40 = 45,000 BTU/HR
 60 = 60,000 BTU/HR
 75 = 75,000 BTU/HR
 90 = 90,000 BTU/HR
 105 = 105,000 BTU/HR
 E = Electric
 N = NOX
- (6) **DRIVE NOMINAL COOLING/REVISION LEVEL**
 3 = 3 Ton
 4 = 4 Ton
 5 = 5 Ton
- (7) **REVISION LEVEL**

SERIAL NUMBER EXPLANATION

H	M	5	D	7	0	2	F	3	1	0	9	9	9	9
1	2	3	4	5	6	7	8	9	10					

- 1 GAS CODE**
- 2 LIMIT CONTROL**
- 3 BLOWER**
- 4 HEATING ELEMENT**
- 5 SPECIAL AREA REQUIREMENT**
- 6 MOTOR HORSEPOWER**
- 7 PLANT**
- 8 WEEK**
- 9 YEAR**
- 10 PRODUCTION NUMBER**

No.	Notes	MODEL HEATING INPUT VARIATIONS	GLDB 45E 3A	GLDB 60E 3A	GLDB 75E 4A	GLDB 90E 5A	GLDB 105E 5A	
PANELS, SHEET METAL, MISCELLANEOUS								
1		Blower/Filter Door	AS-67890-11	AS-67890-11	AS-67890-11	AS-67890-11	AS-67892-09	
2		Burner Door	AS-61866-09	AS-61866-09	AS-61866-09	AS-61866-09	AS-61868-09	
3		Induced Draft Blower w/Gasket	See Electrical Group					
5		Connector/Transition	68-24047-10	68-24047-10	68-24047-11	68-24047-11	68-24047-12	
6		Drain - Double Elbow	79-102881-01	79-102881-01	79-102881-01	79-102881-01	79-102881-01	
7		Elbow/Trap Assembly	68-24048-01	68-24048-01	68-24048-01	68-24048-01	68-24048-01	
8		Water Trap Mount Bracket	AE-61841-01	AE-61841-01	AE-61841-01	AE-61841-01	AE-61841-01	
9		Hose Clamps (4)	64-22043-01	64-22043-01	64-22043-01	64-22043-01	64-22043-01	
10		Drain - Elbow	79-102882-01	79-102882-01	79-102882-01	79-102882-01	79-102882-01	
18		Limit - Main Limit (Heat Exchanger Panel)	See Electrical Group					
19		Heat Exchanger Assembly	See Heat Exchanger Group					
25		Silicon Tubing - Pressure Switch	AE-61737-27	AE-61737-27	AE-61737-27	AE-61737-27	AE-61737-27	
26		Pressure Switch	See Electrical Group					
27		Plug Button - 2 in. opening	45-22980-08	45-22980-08	45-22980-08	45-22980-08	45-22980-08	
28		Door Angle	AS-67847-01	AS-67847-01	AS-67847-02	AS-67847-02	AS-67847-03	
29		Grommet (1-5/8 in. opening)	56-22114-01	56-22114-01	56-22114-01	56-22114-01	56-22114-01	
29		Grommet (2 in. opening)	56-22114-06	56-22114-06	56-22114-06	56-22114-06	56-22114-06	
30		Outlet Pipe Gasket	68-24022-02	68-24022-02	68-24022-02	68-24022-02	68-24022-02	
31		Outlet Pipe Assembly	68-24150-01	68-24150-01	68-24150-01	68-24150-01	68-24150-02	
32		Jacket	AS-67824-08	AS-67824-08	AS-67824-09	AS-67824-09	AS-67824-11	
33		Top Plate	AE-67805-02	AE-67805-02	AE-67805-03	AE-67805-03	AE-67805-04	
		Top Plate Gasket	68-102279-01	68-102279-01	68-102279-02	68-102279-02	68-102279-03	
34		Inlet Air Chase Assembly	AS-67848-01	AS-67848-01	AS-67848-01	AS-67848-01	AS-67848-01	
35		Inlet Air Chase Gasket	68-24022-01	68-24022-01	68-24022-01	68-24022-01	68-24022-01	
36		Plug Button - 2 in. opening	45-22980-08	45-22980-08	45-22980-08	45-22980-08	45-22980-08	
37		Junction Box Cover	AE-61476-02	AE-61476-02	AE-61476-02	AE-61476-02	AE-61476-02	
38		Junction Box	AE-67825-01	AE-67825-01	AE-67825-01	AE-67825-01	AE-67825-01	
39		Door Switch	See Electrical Group					
44		Blower Assembly	See Blower Group					
		Filter - Plastic (2)	54-22699-01	54-22699-01	54-22699-01	54-22699-01	54-22699-02	
		Filter Rack	AE-66681-01	AE-66681-01	AE-66681-01	AE-66681-01	AE-66681-01	

No.	Notes	MODEL HEATING INPUT VARIATIONS	GLDB ALL ALL				
HORIZONTAL INSTALLATION PARTS							
6		Drain - Double Elbow	79-102881-01				
9		Hose Clamps (4)	64-22043-01				
10		Drain - Elbow	79-102882-01				
11		Elbow (Connector/Transition - Trap)	68-24121-01				
12		Trap Assembly	68-24120-02				
13		Trap Gasket	68-24123-01				
14		Hole Plugs (2)	45-24125-01				

No.	Notes	MODEL HEATING INPUT VARIATIONS	GLDB ALL ALL				
PARTS BAG							
		Complete Parts Bag	AS-100717-03				
9		Hose Clamp (2)	64-22043-01				
11		Elbow (Connector/Transition - Trap)	68-24121-01				
12		Trap Assembly	68-24120-02				
13		Trap Gasket	68-24123-01				
14		Hole Plugs (2)	45-24125-01				
		1/2 in. Tee	68-21980-02				
		1/2 in. PVC Pipe - 4 in.	68-22024-04				
		PVC Vane	68-23473-01				
		PVC Wind Vane	68-24049-01				
		Screw - #6-20 x 1/2 in. (2)	63-22153-04				

No.	Notes	MODEL HEATING INPUT VARIATIONS	GLDB 45E 3A	GLDB 60E 3A	GLDB 75E 4A	GLDB 90E 5A	GLDB 105E 5A
ELECTRIC GROUP							
3	Stk	Induced Draft Blower w/Gasket	70-24033-01	70-24033-01	70-24033-01	70-24033-01	70-24033-01
18	Stk	Limit - Main Limit (Heat Exchanger Panel)	47-25350-09	47-25350-07	47-25350-05	47-25350-13	47-25350-05
26	Stk	Pressure Switch	42-101956-01	42-101956-01	42-101956-11	42-101956-01	42-101956-09
39		Door Switch - Push Button	42-22692-02	42-22692-02	42-22692-02	42-22692-02	42-22692-02
49	Stk	Transformer w/Fuse	46-24124-03	46-24124-03	46-24124-03	46-24124-03	46-24124-03
51		Integrated Furnace Control Board (IFC)	See Gas Controls				
52	Stk	Capacitor - Induced Draft Blower	43-100496-44	43-100496-44	43-100496-44	43-100496-44	43-100496-44
53		Capacitor - Blower Motor	See Blower Group				
54	Stk	Limit - Heat Assisted (Blower Housing)	47-22860-02	47-22860-02	47-22860-02	47-22860-02	47-22860-03
61	Stk	Limit - Manual Reset (Burner Compartment)	47-22861-02 (1)	47-22861-02 (1)	47-22861-02 (1)	47-22861-02 (2)	47-22861-02 (2)
	Stk	Limit - Manual Reset (Burner Compartment) - on Center Panel	47-22861-04 (2)	47-22861-04 (2)	47-22861-04 (2)	47-22861-04 (2)	47-22861-04 (2)
		Wiring Harness - 4 pin to 2 ring terminals/1 straight terminal/1 strip back	45-24371-41	45-24371-41	45-24371-41	45-24371-41	45-24371-41
		Direct Spark Wiring Harness - 9 pin from board to 9 pin and 4 pin	45-24371-28	45-24371-28	45-24371-28	45-24371-28	45-24371-28
		Twist Lock - Direct Spark Ignition Wiring Harness - 9 pin to 8 terminals and 6 pin to 4 pin	45-24393-02	45-24393-02	45-24393-02	45-24393-02	45-24393-02
		Direct Spark Ignition Wiring Harness - 2 pin from board to 6 pin, (3 terminals off 6 pin, 1 terminal off 2 pin) - Downflow Models w/HALC	45-24371-29	45-24371-29	45-24371-29	45-24371-29	45-24371-29

No.	Notes	MODEL HEATING INPUT VARIATIONS	GLDB 45E 3A	GLDB 60E 3A	GLDB 75E 4A	GLDB 90E 5A	GLDB 105E 5A
BLOWER GROUP							
44	Stk	Blower Assembly (Includes items 45-48, 53)	AS-61697-38	AS-61697-38	AS-61697-101	AS-61697-40	AS-61697-41
45		Motor Mount Leg (4)	AE-61698-02	AE-61698-02	AE-61698-02	AE-61698-02	AE-61698-02
46	Stk	Blower Motor	51-24042-01	51-24042-01	51-103243-01	51-24043-01	51-24043-01
47		Housing	AS-61674-14	AS-61674-14	AS-61674-15	AS-61674-15	AS-61674-16
48	Stk	Blower Wheel	70-22688-01	70-22688-01	70-20602-01	70-24041-01	70-20602-01
49		Transformer w/Fuse	See Electrical Group				
50		Control Mounting Plate	AE-67877-01	AE-67877-01	AE-67877-01	AE-67877-01	AE-67877-01
51		Integrated Furnace Control Board (IFC)	See Gas Controls				
52		Capacitor - Induced Draft Blower	See Electrical Group				
53	Stk	Capacitor - Blower Motor	43-101666-42	43-101666-42	43-101666-43	43-101666-43	43-101666-43
54		Limit Control w/Heater	See Electrical Group				

No.	Notes	MODEL HEATING INPUT VARIATIONS	GLDB 45E 3A	GLDB 60E 3A	GLDB 75E 4A	GLDB 90E 5A	GLDB 105E 5A
HEAT EXCHANGER, BURNER / MANIFOLD							
3		Induced Draft Blower w/Gasket	See Electrical Group				
18		Limit - Main Limit (Heat Exchanger Panel)	See Electrical Group				
19	Stk	Heat Exchanger	AS-67818-36	AS-67818-37	AS-67818-38	AS-67818-39	AS-67818-40
20		Baffle	AE-61876-01	AE-61875-01	AE-61876-01	AE-61875-01	AE-61876-01
21		Rear Baffle	AE-61878-01	AE-61878-01	AE-61878-02	AE-61878-02	AE-61878-03
22		Baffle	AE-61876-02	AE-61875-02	AE-61876-02	AE-61875-02	AE-61876-02
23		Heat Exchanger Bracket	AE-67846-02	AE-67846-02	AE-67846-02	AE-67846-02	AE-67846-02
24		Heat Exchanger Bracket	AE-61959-01	AE-61959-01	AE-61959-01	AE-61959-01	AE-61959-01
55	Stk	Burners	AS-61984-03	AS-61984-04	AS-61984-05	AS-61984-06	AS-61984-07
56		Burner Support Bracket (2)	AE-61808-01	AE-61808-01	AE-61808-01	AE-61808-01	AE-61808-01
57		Burner Support	AE-61809-11	AE-61809-12	AE-61809-13	AE-61809-14	AE-61809-15
59	Stk	Manifold (w/o Orifices)	81-24396-01	81-24396-02	81-24396-03	81-24396-04	81-24396-05
61		Limit - Manual Reset (Burner Compartment)	See Electrical Group				
62		Flame Sensor	See Gas Controls				
63	Stk	Ignitor - Direct Spark	62-24141-04	62-24141-04	62-24141-04	62-24141-04	62-24141-04
64		Burner Orifice - Natural Gas	See Orifice Selection Chart				
64		Burner Orifice - LP	See Orifice Selection Chart				
		Number of Orifices	(3)	(4)	(5)	(6)	(7)
65		Gas Valve	See Gas Controls				
		Bracket - Flame Roll-out (On Center Panel)	AE-61600-02	AE-61600-02	AE-61600-02	AE-61600-02	AE-61600-02
		Direct Spark Igniter Bracket	AE-61885-02	AE-61885-02	AE-61885-02	AE-61885-02	AE-61885-02

No.	Notes	MODEL GAS CODE	GLDB HL	GLDB HM
GAS CONTROLS				
51	Stk	Integrated Furnace Control Board (IFC)	62-24140-04	62-24140-04
62	Stk	Flame Sensor	62-23543-06	62-23543-06
63		Ignitor - Direct Spark	See Heat Exchanger Group	See Heat Exchanger Group
65	Stk	Gas Valve - Natural Gas	60-24180-01	60-100394-03
65	Stk,1	Gas Valve - LP	See Note 1	See Note 1
		Wiring Harnesses	See Electrical Group	See Electrical Group
	Stk	LP Conversion Kit - US	FP-02	FP-02
	Stk	LP Conversion Kit - Canada	FP-02	FP-02

90% GAS FURNACE - ORIFICE SELECTION CHART - NATURAL GAS

CAUTION: Selection of the correct Natural Gas Orifice requires the following information for the specific installation:

- 1) Altitude in of the installation (ft.).
- 2) Average energy content of the Natural Gas fuel from the local supplier (BTU/cu. ft.).

For detailed information and instructions for Orifice selection, see the Gas Furnace LP Conversion Kit Index 92-21519-59 and the latest edition of the National Fuel Gas Code Handbook, or the National Standard of Canada, Natural Gas and Propane Installation Code, CAN B149.1.

CAUTION: This information is provided for replacement purposes only. Conversion for operation at High Altitude must be done using the kit specified on the product specification sheet for the unit.

NOTE: This Orifice sizing chart is based on 15,000 BTU/HR per burner.

NOTE: Factory installed orifices are calculated and sized based on a Natural Gas heating value of 1075 BTU/cu. ft. and an elevation of 0 - 2000 ft.

Energy Value (BTU/cu. ft.)	Elevation (ft.)							
	0 - 1999	2000 - 2999	3000 - 3999	4000 - 4999	5000 - 5999	6000 - 6999	7000 - 7999	8000 - 8999
850	62-22175-47	62-22175-48	62-22175-48	62-22175-49	62-22175-49	62-22175-49	62-22175-50	62-22175-50
900	62-22175-48	62-22175-49	62-22175-49	62-22175-49	62-22175-50	62-22175-50	62-22175-50	62-22175-51
975	62-22175-49	62-22175-50	62-22175-50	62-22175-50	62-22175-51	62-22175-51	62-22175-51	62-22175-52
1075	62-22175-50	62-22175-51	62-22175-51	62-22175-51	62-22175-51	62-22175-52	62-22175-52	62-22175-52
1170	62-22175-51	62-22175-51	62-22175-52	62-22175-52	62-22175-52	62-22175-53	62-22175-53	62-22175-53

90% GAS FURNACE - ORIFICE SELECTION CHART - LP

CAUTION: Selection of the correct LP Orifice requires the altitude of the specific installation (ft.).

For detailed information and instructions for Orifice selection, see the Gas Furnace LP Conversion Kit Index 92-21519-59 and the latest edition of the National Fuel Gas Code Handbook (NFG), or the National Standard of Canada, Natural Gas and Propane Installation Code, CAN B149.1.

CAUTION: This information is provided for replacement purposes only. Conversion to LP or for operation at High Altitude should be done using the kit(s) specified on the product specification sheet for the unit.

NOTE: This Orifice sizing chart is based on 15,000 BTU/HR per burner. Also, the chart is developed using the specified pressure setting of 10 in. water column instead of the 11.0 in water column used by the NFG and CANB149.1.

NOTE: Orifices supplied in the LP Conversion Kit are calculated and sized based on an altitude of 0 - 2000 ft.

Elevation (ft.)	Orifice							
0 to 2000 ft.	62-22175-91							
2001 to 3000	62-22175-91							
3001 to 4000	62-22175-90							
4001 to 5000	62-22175-58							
5001 to 6000	62-22175-59							
6001 to 7000	62-22175-60							
7001 to 8000	62-22175-62							
8001 to 9000	62-22175-63							
9001 to 1000	62-22175-64							

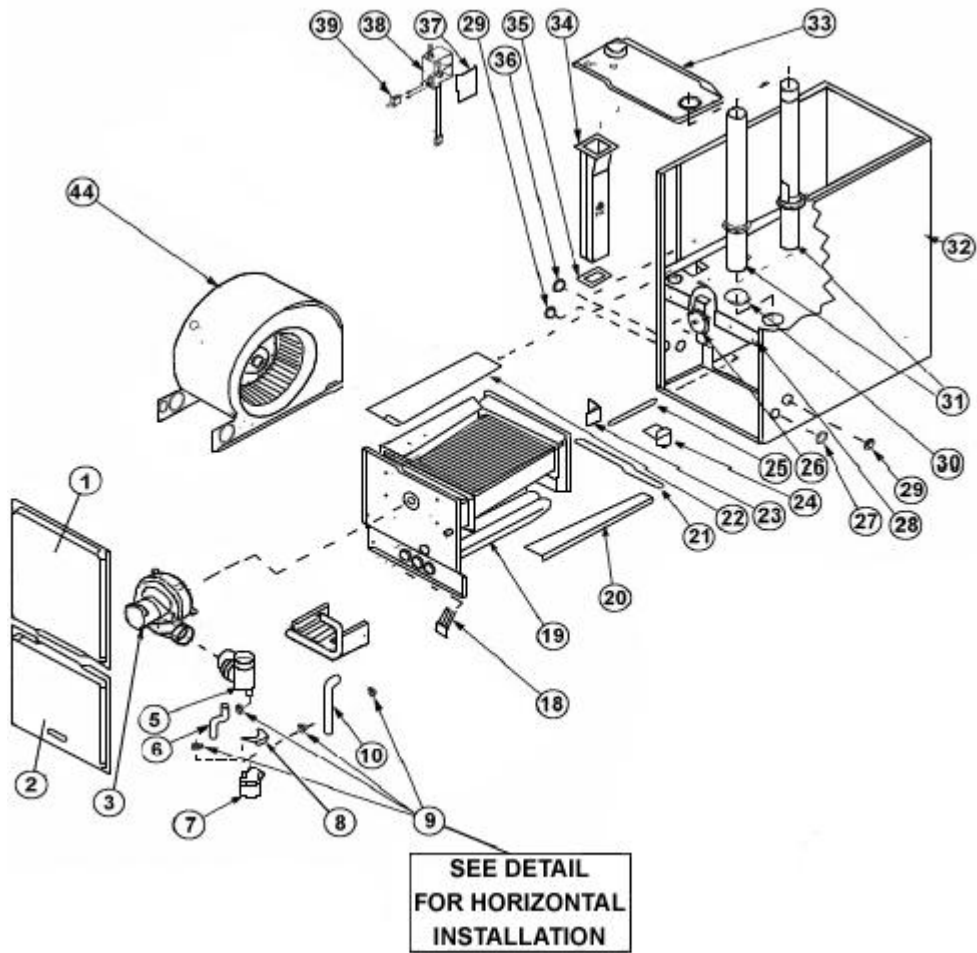

Exploded View

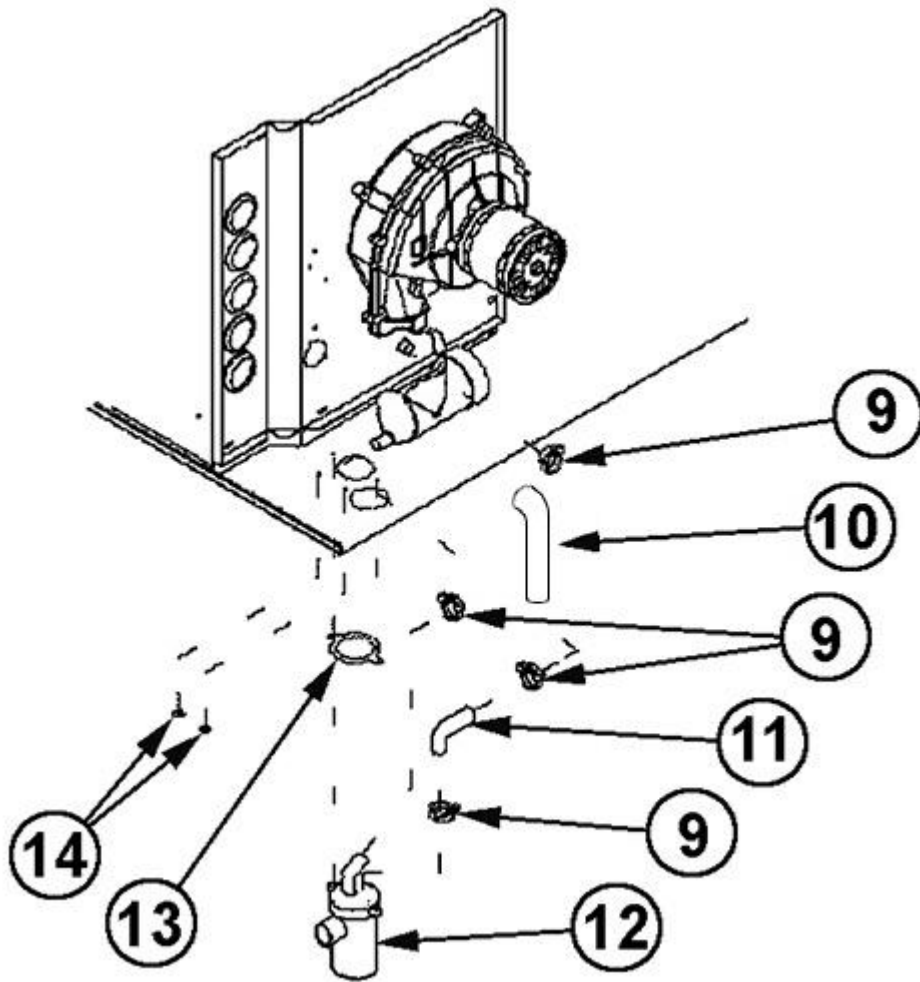

Horizontal Installation Parts

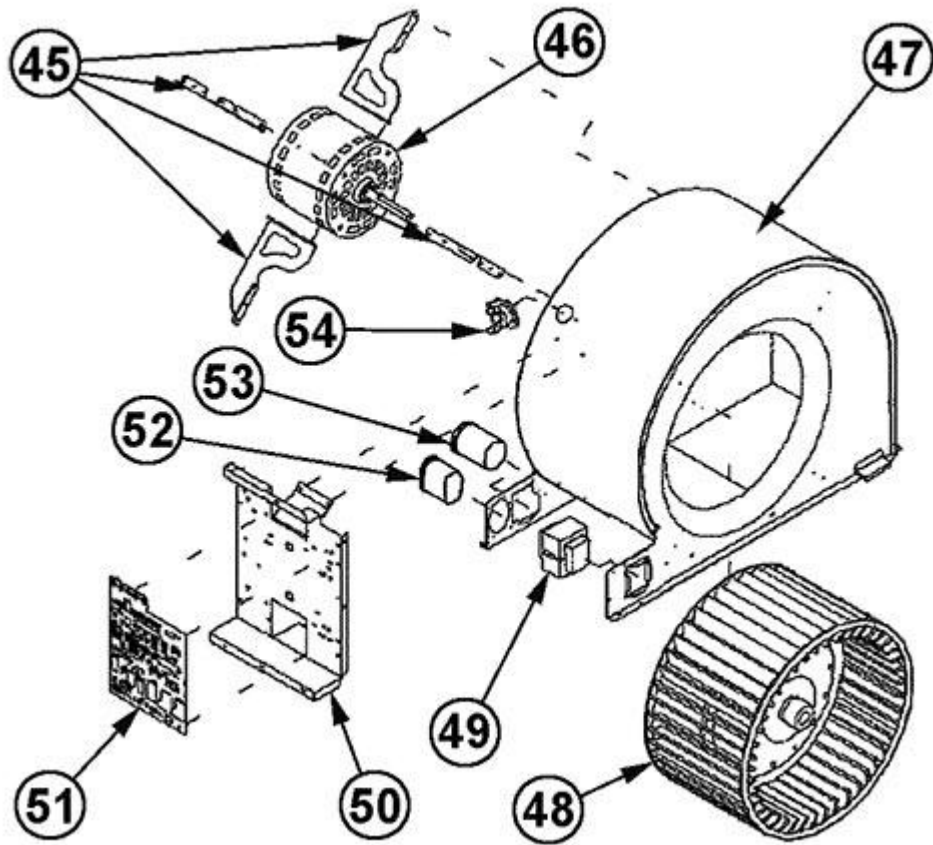

Blower Assembly

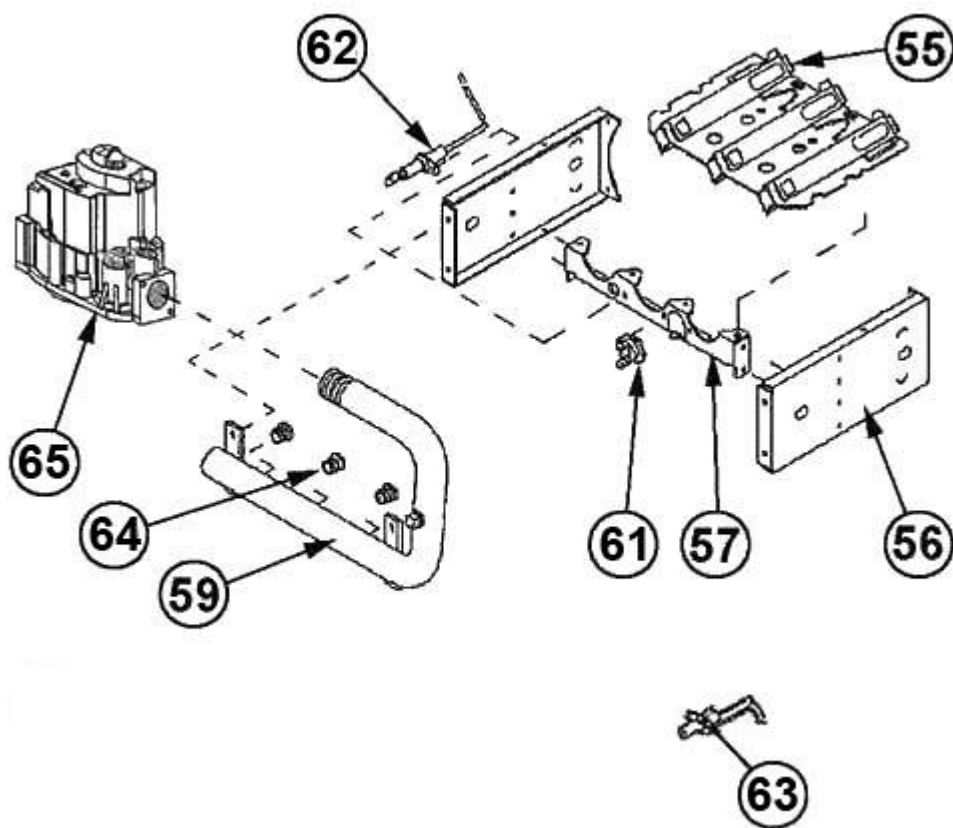

Burner Assembly

NOTES

Stk It is recommended that stock be maintained for this part.
N/A Not Applicable
1 Order Gas Valve for Natural Gas along with LP Conversion Kit.