

This Owner's Manual is provided and hosted by [Appliance Factory Parts](#).



COMFORT-AIRE GLUB60E-3A Owner's Manual

[Shop genuine replacement parts for COMFORT-AIRE
GLUB60E-3A](#)



[Find Your COMFORT-AIRE HVAC Parts - Select From 1486 Models](#)

----- Manual continues below -----

HEAT CONTROLLER, INC.

GLUB-A

Parts List
18-October-2011



This parts list is current as of the above revision date.

Form Number: 92-42810-GLUB-A

Table of Contents

Model Explanation	Page 3
Parts Numbers	
Panels - Miscellaneous	Page 4
Electrical Group	Page 5
Blower Group	Page 5
Heat Exchanger-Burner Group	Page 6
Gas Controls	Page 7
Orifice Selection Chart	Page 8
Drawings/Photographs	
Exploded View	Page 9
Blower Assembly	Page 10
Burner Assembly	Page 11
Notes	Page 12

MODEL NUMBER EXPLANATION

G	L	U	B	-	4	5	E	3	A
1	2	3	4			5		6	7

- (1) **GAS**
- (2) **95% EFFICIENCY**
- (3) **UPFLOW CONDENSING**
- (4) **PLACEHOLDER**
- (5) **HEATING INPUT DESIGNATION**
 40 = 45,000 BTU/HR
 60 = 60,000 BTU/HR
 75 = 75,000 BTU/HR
 90 = 90,000 BTU/HR
 105 = 105,000 BTU/HR
 E = Electric
 N = NOX
- (6) **DRIVE NOMINAL COOLING/REVISION LEVEL**
 3 = 3 Ton
 4 = 4 Ton
 5 = 5 Ton
- (7) **REVISION LEVEL**

SERIAL NUMBER EXPLANATION

H	L	5	D	7	0	2	F	3	1	0	9	9	9	9
1	2	3	4	5	6	7	8	9	10					

- 1 GAS CODE**
- 2 LIMIT CONTROL**
- 3 BLOWER**
- 4 HEATING ELEMENT**
- 5 SPECIAL AREA REQUIREMENT**
- 6 MOTOR HORSEPOWER**
- 7 PLANT**
- 8 WEEK**
- 9 YEAR**
- 10 PRODUCTION NUMBER**

No.	Notes	MODEL HEATING INPUT VARIATIONS	GLUB 45E 3A	GLUB 60E 3A	GLUB 75E 3A	GLUB 75E 4A	GLUB 90E 5A	GLUB 105E 5A
PANELS, SHEET METAL, MISCELLANEOUS								
1		Jacket	AS-61824-04	AS-61824-04	AS-61824-04	AS-61824-05	AS-61824-05	AS-61824-05
2		O-Ring - Fresh Air Damper	68-24032-01	68-24032-01	68-24032-01	68-24032-01	68-24032-01	68-24032-01
3		Adapter - Fresh Air Damper and Locknut	68-24114-01	68-24114-01	68-24114-01	68-24114-01	68-24114-01	68-24114-01
4		Outlet Air Pipe	68-24021-01	68-24021-01	68-24021-01	68-24021-03	68-24021-01	68-24021-01
5		Gasket - Outlet Air Pipe	68-24022-02	68-24022-02	68-24022-02	68-24022-02	68-24022-02	68-24022-02
6		Top Plate	AS-61872-01	AS-61872-01	AS-61872-01	AS-61872-02	AS-61872-02	AS-61872-02
7		Locknut - Fresh Air Damper	64-24031-01	64-24031-01	64-24031-01	64-24031-01	64-24031-01	64-24031-01
8		Burner Door	AS-61866-09	AS-61866-09	AS-61866-09	AS-61867-09	AS-61867-09	AS-61867-09
9		Blower/Filter Door	AS-67890-11	AS-67890-11	AS-67890-11	AS-67891-11	AS-67891-11	AS-67891-11
10		Filter - Plastic	54-24094-01	54-24094-01	54-24094-01	54-24094-02	54-24094-02	54-24094-02
		Filter Retainer Rod	45-24095-01	45-24095-01	45-24095-01	45-24095-01	45-24095-01	45-24095-01
		Filter Rod Support Angle	AE-60520-01	AE-60520-01	AE-60520-01	AE-60520-01	AE-60520-01	AE-60520-01
		Filter Support Angle	AE-61883-01	AE-61883-01	AE-61883-01	AE-61883-01	AE-61883-01	AE-61883-01
11		Solid Bottom	AE-61874-02	AE-61874-02	AE-61874-02	AE-61874-03	AE-61874-03	AE-61874-03
12		Pressure Switch Assembly	See Electrical Group					
13		Trap/Elbow Assembly	68-24048-01	68-24048-01	68-24048-01	68-24048-01	68-24048-01	68-24048-01
14		Water Trap Mount Bracket	AE-61841-01	AE-61841-01	AE-61841-01	AE-61841-01	AE-61841-01	AE-61841-01
15		Junction Box Cover	AE-61476-02	AE-61476-02	AE-61476-02	AE-61476-02	AE-61476-02	AE-61476-02
16		Door Switch (Push Button)	See Electrical Group					
17		Junction Box	AE-61475-02	AE-61475-02	AE-61475-02	AE-61475-02	AE-61475-02	AE-61475-02
28		Heat Exchanger	See Heat Exchanger Group					
29		Limit - Main Limit (Heat Exchanger Panel)	See Electrical Group					
30		Connector/Transition	68-24047-07	68-24047-07	68-103061-01	68-24047-08	68-24047-08	68-24047-08
31		Induced Draft Blower w/Gasket	See Electrical Group					
A		Button Plug - 2 in. opening	45-22980-08	45-22980-08	45-22980-08	45-22980-08	45-22980-08	45-22980-08
B		Button Plug - 2-3/8 in. opening (2)	45-22980-03	45-22980-03	45-22980-03	45-22980-03	45-22980-03	45-22980-03
C		Silicon Tubing for Pressure Switch (2)	AE-61737-10	AE-61737-10	AE-61737-10	AE-61737-10	AE-61737-10	AE-61737-10
D		Hose Clamp (6)	64-22043-02	64-22043-02	64-22043-02	64-22043-02	64-22043-02	64-22043-02
E		Elbow (Induced Draft Blower - 1/2 in. barbed)	68-24013-01	68-24013-01	68-24013-01	68-24013-01	68-24013-01	68-24013-01
F		Grommet - 7/8 in. I.D. (2 in. groove diameter)	56-22114-06	56-22114-06	56-22114-06	56-22114-06	56-22114-06	56-22114-06
G		Tubing - Includes Two Hose Clamps (3)	79-25353-82	79-25353-82	79-25353-82	79-25353-82	79-25353-82	79-25353-82
		Tubing (Drain Trap to Induced Draft Blower - Includes two Hose Clamps)	791000	791000	791000	791001	791001	791001
		Grommet - 19/32 in. I.D. (7/8 in. groove diameter)	56-22521-03	56-22521-03	56-22521-03	56-22521-03	56-22521-03	56-22521-03
		Grommet- 1/2 in. I.D. (5/8 in. groove diameter)	56-24008-01	56-24008-01	56-24008-01	56-24008-01	56-24008-01	56-24008-01
		Grommet -1/4 in. I.D. (3/8 in. groove diameter)	56-24008-02	56-24008-02	56-24008-02	56-24008-02	56-24008-02	56-24008-02

No.	Notes	MODEL HEATING INPUT VARIATIONS	GLUB ALL ALL					
PARTS BAG								
		Complete Parts Bag	AS-100717-01					
2		O-Ring - Fresh Air Damper	68-24032-01					
3		Adapter - Fresh Air Damper and Locknut	68-24114-01					
		1/2 in. Tee	68-21980-02					
		1/2 in. PVC Pipe - 4 in.	68-22024-04					
		Plug - Nylon - 7/8 in.	45-22926-01					
		Plug - Nylon - 1-1/8 in.	45-22926-02					
		PVC Vane	68-23473-01					
		PVC Wind Vane - 2-1/2 in.	68-24049-01					
		Hose Clamp (2)	64-22043-02					

No.	Notes	MODEL HEATING INPUT VARIATIONS	GLUB 45E 3A	GLUB 60E 3A	GLUB 75E 3A	GLUB 75E 4A	GLUB 90E 5A	GLUB 105E 5A
ELECTRIC GROUP								
12a	Stk	Pressure Switch - Drain	42-101955-02	42-101955-02	42-101955-08	42-101955-02	42-101955-02	42-101955-02
12b	Stk	Pressure Switch - Vent	42-101956-01	42-101956-01	42-101956-12	42-101956-09	42-101956-01	42-101956-01
16	Stk	Door Switch - Push Button	42-22692-02	42-22692-02	42-22692-02	42-22692-02	42-22692-02	42-22692-02
19	Stk	Transformer	46-24124-03	46-24124-03	46-24124-03	46-24124-03	46-24124-03	46-24124-03
21		Integrated Furnace Control Board (IFC)	See Gas Controls					
22		Capacitor - Blower Motor	See Blower Group					
23	Stk	Capacitor - Induced Draft Blower	43-100496-44	43-100496-44	43-100496-44	43-100496-44	43-100496-44	43-100496-44
29	Stk	Limit - Main Limit (Heat Exchanger Panel)	47-25350-06	47-25350-05	47-25350-09	47-25350-01	47-25350-01	47-25350-07
31	Stk	Induced Draft Blower w/Gasket	70-102691-01	70-102691-01	70-102691-01	70-102691-01	70-102691-01	70-102691-01
34a	Stk	Limit - Manual Reset (Burner Compartment)	47-22861-02 (1)	47-22861-02 (1)	47-22861-02 (2)	47-22861-02 (2)	47-22861-02 (2)	47-22861-02 (2)
		Wiring Harness - 9 pin from board to (9 pin/4 pin), 8 wires from 9 pin	45-24371-01	45-24371-01	45-24371-01	45-24371-01	45-24371-01	45-24371-01
		Wiring Harness - 4 pin to 2 ring terminals/1 straight terminal/1 strip back	45-24371-12	45-24371-12	45-24371-12	45-24371-12	45-24371-12	45-24371-12
		Direct Spark Wiring Harness - 9 pin to 8 terminals and 6 pin to 4 pin, w/Twist Lock, 8 wires from 9 pin	45-24393-01	45-24393-01	45-24393-01	45-24393-01	45-24393-01	45-24393-01
		Direct Spark Wiring Harness - 2 pin from board to (6 pin with 2 flag terminals), 4 wires from 6 pin	45-24371-27	45-24371-27	45-24371-27	45-24371-27	45-24371-27	45-24371-27

No.	Notes	MODEL HEATING INPUT VARIATIONS	GLUB 45E 3A	GLUB 60E 3A	GLUB 75E 3A	GLUB 75E 4A	GLUB 90E 5A	GLUB 105E 5A
BLOWER GROUP								
18	Stk	Blower Assembly (Includes items 22, 24-27)	AS-61697-15	AS-61697-15	AS-61697-15	AS-61697-102	AS-61697-18	AS-61697-18
19		Transformer w/Fuse	See Electrical Group					
20		Mounting Plate - Control	AE-67877-01	AE-67877-01	AE-67877-01	AE-67877-01	AE-67877-01	AE-67877-01
21		Integrated Furnace Control Board (IFC)	See Gas Controls					
22	Stk	Capacitor - Blower Motor	43-101666-42	43-101666-42	43-101666-42	43-101666-43	43-101666-43	43-101666-43
23		Capacitor - Induced Draft Blower	See Electrical Group					
24	Stk	Blower Motor	51-24042-01	51-24042-01	51-24042-01	51-103243-01	51-24043-01	51-24043-01
25		Motor Mount Leg (4)	AE-61698-02	AE-61698-02	AE-61698-02	AE-61698-02	AE-61698-02	AE-61698-02
26		Housing	AS-61674-02	AS-61674-02	AS-61674-02	AS-61674-08	AS-61674-08	AS-61674-08
27	Stk	Blower Wheel	70-22688-01	70-22688-01	70-22688-01	70-20602-01	70-24041-01	70-24041-01

No.	Notes	MODEL HEATING INPUT VARIATIONS	GLUB 45E 3A	GLUB 60E 3A	GLUB 75E 3A	GLUB 75E 4A	GLUB 90E 5A	GLUB 105E 5A
HEAT EXCHANGER, BURNER / MANIFOLD								
28	Stk	Heat Exchanger	AS-61805-59	AS-61805-60	AS-61805-61	AS-61805-62	AS-61805-63	AS-61805-64
29		Limit - Main Limit (Heat Exchanger Panel)	See Electrical Group					
31		Induced Draft Blower w/Gasket	See Electrical Group					
32	Stk	Burner Assembly	AS-61984-03	AS-61984-04	AS-61984-05	AS-61984-05	AS-61984-06	AS-61984-07
33		Burner Diffuser	AE-61882-12	AE-61882-11	AE-61882-07	AE-61882-07	AE-61882-08	AE-61882-09
34a		Limit - Manual Reset (Burner Compartment)	See Electrical Group					
34b		Limit Control Bracket	AE-61913-02 (1)	AE-61913-02 (1)	AE-61913-02 (2)	AE-61913-02 (2)	AE-61913-02 (2)	AE-61913-02 (2)
35		Burner Shield	AE-61807-01	AE-61807-02	AE-61807-03	AE-61807-03	AE-61807-04	AE-61807-05
36	Stk	Manifold (w/o Orifices)	81-24395-01	81-24395-02	81-24395-03	81-24395-03	81-24395-04	81-24395-05
37		Burner Orifice - Natural Gas	See Orifice Selection Chart					
37		Burner Orifice - LP	See Orifice Selection Chart					
37		Number of Orifices	(3)	(4)	(5)	(5)	(6)	(7)
39		Flame Sensor	See Gas Controls					
40	Stk	Ignitor - Direct Spark Ignition	62-24141-04	62-24141-04	62-24141-04	62-24141-04	62-24141-04	62-24141-04
41		Burner Support	AE-61809-11	AE-61809-12	AE-61809-13	AE-61809-13	AE-61809-14	AE-61809-15
42		Burner Support Bracket (2)	AE-61808-01	AE-61808-01	AE-61808-01	AE-61808-01	AE-61808-01	AE-61808-01
		Bracket - Direct Spark Ignition	AE-61885-02	AE-61885-02	AE-61885-02	AE-61885-02	AE-61885-02	AE-61885-02

No.	Notes	MODEL GAS CODE	GLUB HL	GLUB HM
GAS CONTROLS				
21	Stk	Integrated Furnace Control Board (IFC)	62-24140-04	62-24140-04
38	Stk	Gas Valve - Natural Gas	60-24180-01	60-100394-03
38	Stk, 1	Gas Valve - LP	See Note 1	See Note 1
39	Stk	Flame Sensor	62-23543-06	62-23543-06
40		Ignitor	See Heat Exchanger Group	
	Stk	LP Conversion Kit - US	FP-02	FP-02
	Stk	LP Conversion Kit - Canada	FP-02	FP-02

90% GAS FURNACE - ORIFICE SELECTION CHART - NATURAL GAS

CAUTION: Selection of the correct Natural Gas Orifice requires the following information for the specific installation:

- 1) Altitude in of the installation (ft.).
- 2) Average energy content of the Natural Gas fuel from the local supplier (BTU/cu. ft.).

For detailed information and instructions for Orifice selection, see the Gas Furnace LP Conversion Kit Index 92-21519-59 and the latest edition of the National Fuel Gas Code Handbook, or the National Standard of Canada, Natural Gas and Propane Installation Code, CAN B149.1.

CAUTION: This information is provided for replacement purposes only. Conversion for operation at High Altitude must be done using the kit specified on the product specification sheet for the unit.

NOTE: This Orifice sizing chart is based on 15,000 BTU/HR per burner.

NOTE: Factory installed orifices are calculated and sized based on a Natural Gas heating value of 1075 BTU/cu. ft. and an elevation of 0 - 2000 ft.

Energy Value (BTU/cu. ft.)	Elevation (ft.)							
	0 - 1999	2000 - 2999	3000 - 3999	4000 - 4999	5000 - 5999	6000 - 6999	7000 - 7999	8000 - 8999
850	62-22175-47	62-22175-48	62-22175-48	62-22175-49	62-22175-49	62-22175-49	62-22175-50	62-22175-50
900	62-22175-48	62-22175-49	62-22175-49	62-22175-49	62-22175-50	62-22175-50	62-22175-50	62-22175-51
975	62-22175-49	62-22175-50	62-22175-50	62-22175-50	62-22175-51	62-22175-51	62-22175-51	62-22175-52
1075	62-22175-50	62-22175-51	62-22175-51	62-22175-51	62-22175-51	62-22175-52	62-22175-52	62-22175-52
1170	62-22175-51	62-22175-51	62-22175-52	62-22175-52	62-22175-52	62-22175-53	62-22175-53	62-22175-53

90% GAS FURNACE - ORIFICE SELECTION CHART - LP

CAUTION: Selection of the correct LP Orifice requires the altitude of the specific installation (ft.).

For detailed information and instructions for Orifice selection, see the Gas Furnace LP Conversion Kit Index 92-21519-59 and the latest edition of the National Fuel Gas Code Handbook (NFG), or the National Standard of Canada, Natural Gas and Propane Installation Code, CAN B149.1.

CAUTION: This information is provided for replacement purposes only. Conversion to LP or for operation at High Altitude should be done using the kit(s) specified on the product specification sheet for the unit.

NOTE: This Orifice sizing chart is based on 15,000 BTU/HR per burner. Also, the chart is developed using the specified pressure setting of 10 in. water column instead of the 11.0 in water column used by the NFG and CANB149.1.

NOTE: Orifices supplied in the LP Conversion Kit are calculated and sized based on an altitude of 0 - 2000 ft.

Elevation (ft.)	Orifice							
0 to 2000 ft.	62-22175-91							
2001 to 3000	62-22175-91							
3001 to 4000	62-22175-90							
4001 to 5000	62-22175-58							
5001 to 6000	62-22175-59							
6001 to 7000	62-22175-60							
7001 to 8000	62-22175-62							
8001 to 9000	62-22175-63							
9001 to 1000	62-22175-64							

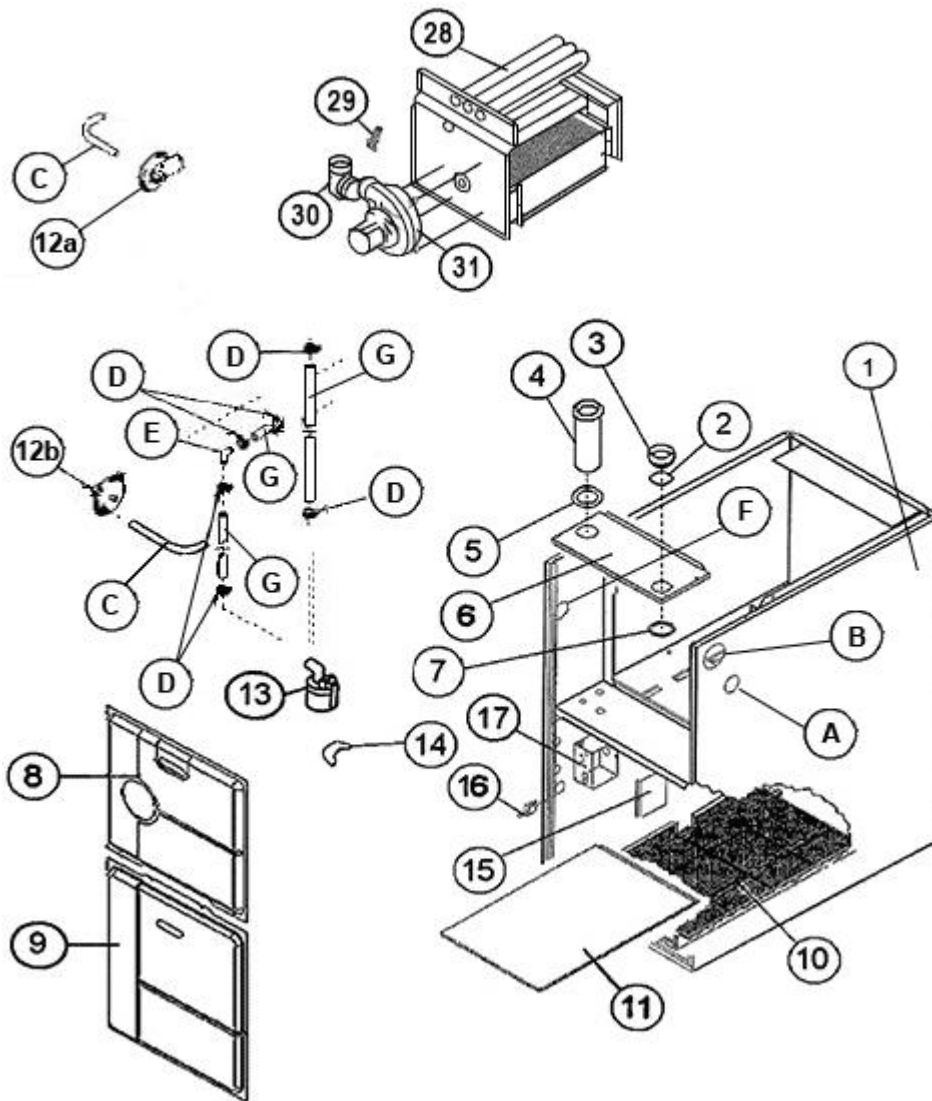

Exploded View

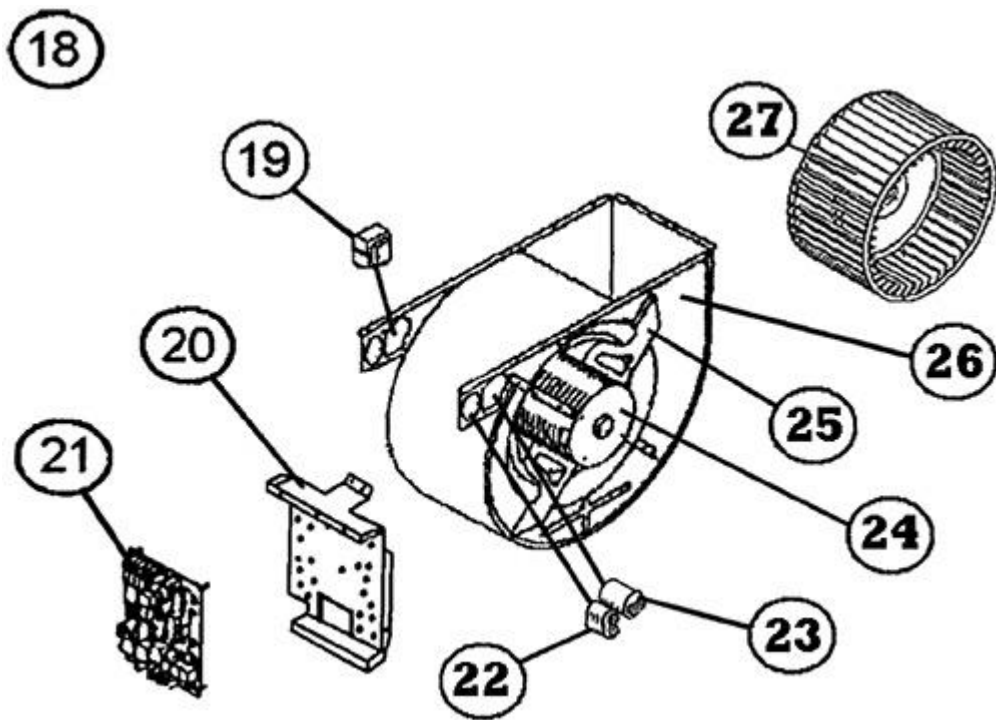

Blower Assembly

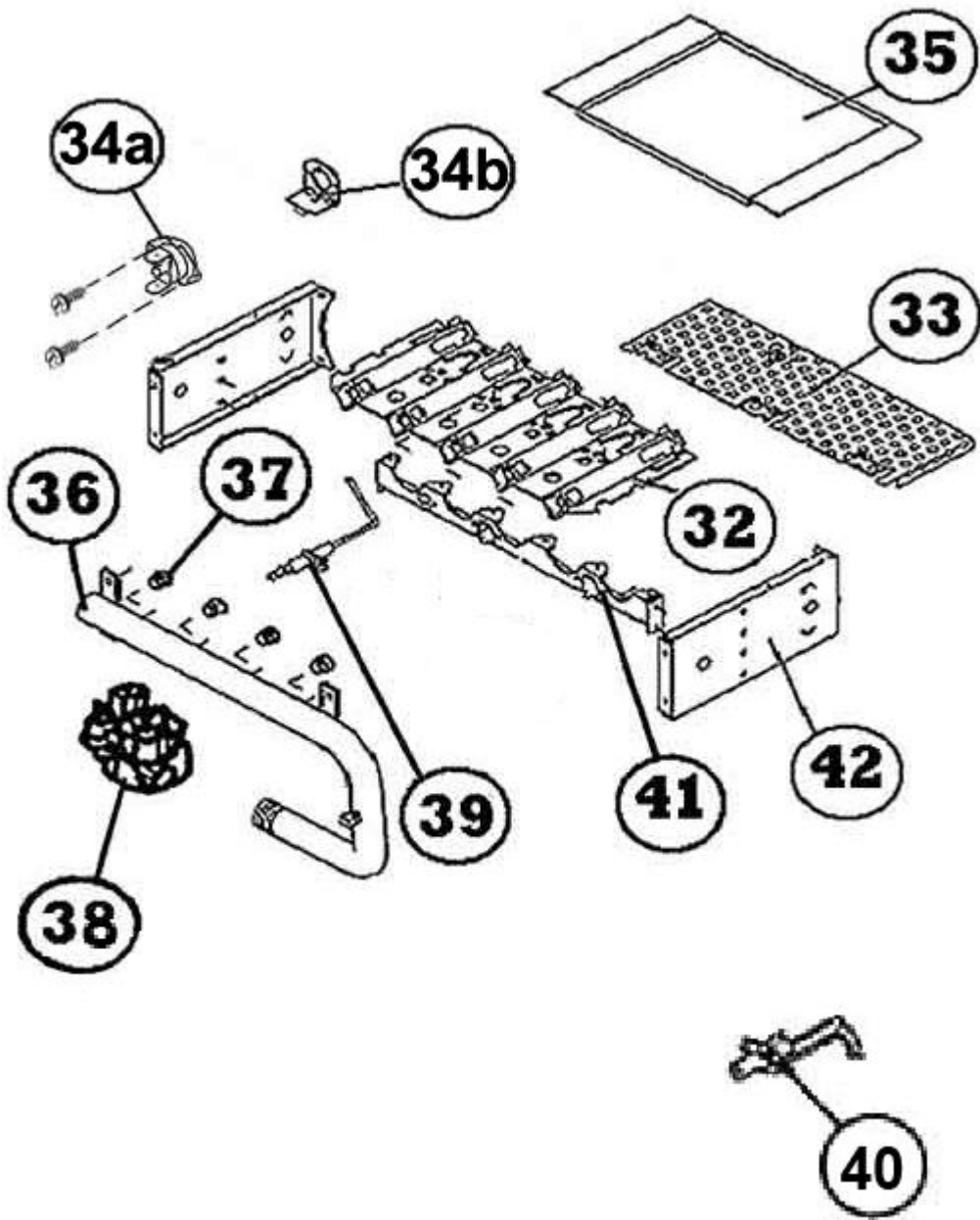

Burner Assembly

NOTES

Stk It is recommended that stock be maintained for this part.
N/A Not Applicable
1 Order Gas Valve for Natural Gas along with LP Conversion Kit.