

This Owner's Manual is provided and hosted by [Appliance Factory Parts](#).



COMFORT-AIRE RSG1436-1A Owner's Manual

[Shop genuine replacement parts for COMFORT-AIRE
RSG1436-1A](#)



[Find Your COMFORT-AIRE HVAC Parts - Select From 1487 Models](#)

----- Manual continues below -----

HEAT CONTROLLER, INC.

RSG14-1A

Parts List
29-May-2009



This parts list is current as of the above revision date.

Form Number: 92-42810-RSG14-1A

Table of Contents

Model Explanation	Page 3
Parts Numbers	
Panels - Miscellaneous.....	Page 4
Electrical-Fan Group	Page 5
Coil Parts	Page 5
Compressor Group.....	Page 6
Accessories.....	Page 7
Drawings/Photographs	
Exploded View	Page 8
Valve Mounting Detail	Page 9
Control Box	Page 10
Notes	Page 11

MODEL NUMBER EXPLANATION

R	S	G	1	4	1	8	-	1	A
1				2		3			

- (1) **SERIES**
- (2) **COOLING CAPACITY (BTU/HR)**
 - 18= 18,000
 - 24= 24,000
 - 30= 30,000
 - 36= 36,000
 - 42= 42,000
 - 48= 48,000
 - 60= 60,000

- (3) **OPTIONS**

SERIAL NUMBER EXPLANATION

7	0	9	2	M	0	7	0	1	9	9	9	9	9
1				2	3		4		5				

- (1) **COMPRESSOR IDENTIFICATION NUMBER**
- (2) **PRODUCTION LOCATION**
- (3) **WEEK OF PRODUCTION**
- (4) **YEAR OF PRODUCTION**
- (5) **PRODUCTION NUMBER**

No.	Notes	MODEL COOLING CAPACITY VARIATION	RSG14	RSG14	RSG14	RSG14
			18 1A	24 1A	30 1A	36 1A
SHEET METAL PARTS, MISCELLANEOUS						
1		Cabinet	AE-100726-32	AE-100726-32	AE-100726-33	AE-100726-34
2		Cabinet Panel	AE-100727-32	AE-100727-32	AE-100727-33	AE-100727-34
3		Base Pan	AE-100069-02	AE-100069-02	AE-101588-03	AE-101588-03
4		Control Box	AE-100654-31	AE-100654-31	AE-100654-31	AE-100657-31
5		Control Box Cover	AE-100657-31	AE-100657-31	AE-100657-31	AE-100657-31
6		Top Panel	AE-100652-02	AE-100652-02	AE-100652-03	AE-100652-03
8		Grille	95-100906-03	95-100906-03	95-100906-04	95-100906-04
12		Valve Mounting Panel	AE-57780-01	AE-57780-01	AE-57780-01	AE-100185-31
14		Service Valve - Suction	See Coil Group			
15		Service Valve - Liquid	See Coil Group			
17		Low Voltage Cover	AE-57756-01	AE-57756-01	AE-57756-01	AE-57756-01
		Touch-up Paint - Dark Gray (Aerosol)	523009	523009	523009	523009
		Touch-up Paint - Dark Gray (Paint Pens)	523011	523011	523011	523011
		Touch-up Paint - Light Gray (Aerosol)	523014	523014	523014	523014
		Touch-up Paint - Light Gray (Paint Pens)	523015	523015	523015	523015

No.	Notes	MODEL COOLING CAPACITY VARIATION	RSG14	RSG14	RSG14	
			42 1A	48 1A	60 1A	
SHEET METAL PARTS, MISCELLANEOUS						
1		Cabinet	AE-100726-34	AE-100726-34	AE-100726-34	
2		Cabinet Panel	AE-100727-34	AE-100727-34	AE-100727-34	
3		Base Pan	AE-101588-03	AE-101588-03	AE-101588-03	
4		Control Box	AE-100654-33	AE-100654-34	AE-100654-34	
5		Control Box Cover	AE-100657-31	AE-100657-31	AE-100657-31	
6		Top Panel	AE-100652-03	AE-100652-03	AE-100652-03	
8		Grille	95-100906-04	95-100906-04	95-100906-04	
		Center Cap - Blank (for Grille)	91-101123-09	91-101123-09	91-101123-09	
12		Valve Mounting Panel	AE-100185-31	AE-100185-31	AE-100185-31	
14		Service Valve - Suction	See Coil Group			
15		Service Valve - Liquid	See Coil Group			
17		Low Voltage Cover	AE-57756-01	AE-57756-01	AE-57756-01	
		Touch-up Paint - Dark Gray (Aerosol)	523009	523009	523009	
		Touch-up Paint - Dark Gray (Paint Pens)	523011	523011	523011	
		Touch-up Paint - Light Gray (Aerosol)	523014	523014	523014	
		Touch-up Paint - Light Gray (Paint Pens)	523015	523015	523015	

No.	Notes	MODEL COOLING CAPACITY VARIATION	RSG14 18 1A	RSG14 24 1A	RSG14 30 1A	RSG14 36 1A
ELECTRICAL/FAN GROUP						
7	Stk	Fan Motor	51-101774-02	51-101774-02	51-101774-02	51-101774-03
9	Stk	Fan Blade	70-102033-02	70-102033-02	70-102011-03	70-102011-04
16	Stk	Contactora	42-42478-03	42-42478-03	42-42478-03	42-42478-03
17		Low Voltage Cover	See Panels - Miscellaneous			
18		Control Box Bottom	AE-100655-01	AE-100655-01	AE-100655-01	AE-100655-01
19		Capacitor - Compressor/Fan	See Compressor Group			

No.	Notes	MODEL COOLING CAPACITY VARIATION	RSG14 42 1A	RSG14 48 1A	RSG14 60 1A	
ELECTRICAL/FAN GROUP						
7	Stk	Fan Motor	51-101774-03	51-101774-03	51-101774-03	
9	Stk	Fan Blade	70-102011-04	70-102011-04	70-102011-04	
16	Stk	Contactora	42-42478-03	42-42478-03	42-42728-02	
17		Low Voltage Cover	See Panels - Miscellaneous			
18		Control Box Bottom	AE-100655-01	AE-100655-01	AE-100655-01	
19		Capacitor - Compressor/Fan	See Compressor Group			

No.	Notes	MODEL COOLING CAPACITY VARIATION	RSG14 18 1A	RSG14 24 1A	RSG14 30 1A	RSG14 36 1A
COIL GROUP						
11	Stk	Condenser Coil	AS-102485-03	AS-102485-03	AS-101761-03	AS-102486-03
13		Valve Mounting Bracket	AE-57781-01	AE-57781-01	AE-57781-01	AE-57781-02
14		Service Valve - Suction	61-21368-07	61-21368-07	61-21368-07	61-21368-22
15		Service Valve - Liquid	61-21368-05	61-21368-05	61-21368-05	61-21368-05
		Distributor - Two Way (1/2 in. to 1/2 in.)	83-19988-01	83-19988-01	N/A	N/A
		Distributor - Three Way (3/8 in. to 3/8 in.)	N/A	N/A	83-17467-07	N/A
		Filter Drier	83-26186-02	83-26186-02	83-26186-02	83-26186-02

No.	Notes	MODEL COOLING CAPACITY VARIATION	RSG14 42 1A	RSG14 48 1A	RSG14 60 1A	
COIL GROUP						
11	Stk	Condenser Coil	AS-102241-03	AS-102242-01	AS-102242-01	
13		Valve Mounting Bracket	AE-57781-02	AE-57781-02	AE-57781-02	
14		Service Valve - Suction	61-21368-08	61-21368-08	61-21368-08	
15		Service Valve - Liquid	61-21368-05	61-21368-05	61-21368-05	
		Filter Drier	83-26186-02	83-26186-02	83-26186-02	

No.	Notes	MODEL COOLING CAPACITY VARIATION	RSG14 18 1A	RSG14 24 1A	RSG14 30 1A	RSG14 36 1A
COMPRESSOR GROUP						
IMPORTANT NOTE: Replacement Compressors MUST be selected using the Compressor ID from the unit's Serial Number. Do not interchange compressors from other Compressor ID's used on the model.						
		Compressor ID:	7833	7772	7773	7774
10	1	Original Compressor - See Note 1	55-101545-38S	55-101545-32S	55-101545-31S	55-102282-07S
10	Stk,1	Replacement Compressor (Retrofit Kit Required) - See Note 1	55-102045-14S	55-102045-24S	55-102045-02S	55-102045-03S
	Stk,1	Retrofit Kit - See Note 1	831016	831016	831027	831024
		Grommet (4)	56-18518-04	56-18518-04	56-18518-04	56-18518-06
		Check Valve (Original Compressor)	83-102440-01	83-102440-01	83-102440-01	N/A
19	Stk	Capacitor - Compressor/Fan (Original Compressor)	43-26261-40	43-26261-44	43-26261-44	43-26261-48
		Compressor ID:	7765	7766	7767	7768
10	Stk	Compressor	55-102045-14S	55-102045-24S	55-102045-02S	55-102045-03S
		Grommet (4)	56-18518-04	56-18518-04	56-18518-04	56-18518-04
19	Stk	Capacitor - Compressor/Fan	43-26261-40	43-26261-44	43-26261-09	43-26261-48
	Stk	Compressor Wiring Harness (Molded Plug)	45-100834-80	45-100834-80	45-100834-80	45-100834-80

No.	Notes	MODEL COOLING CAPACITY VARIATION	RSG14 42 1A	RSG14 48 1A	RSG14 60 1A	
COMPRESSOR GROUP						
		Compressor ID:	7769	7770	7771	
10	Stk	Compressor	55-102045-15S	55-102045-09S	55-102045-26S	
		Grommet (4)	56-18518-06	56-18518-06	56-18518-06	
19	Stk	Capacitor - Compressor/Fan	43-26261-48	43-26261-47	43-26261-47	
	Stk	Compressor Wiring Harness (Molded Plug)	45-100834-80	45-100834-80	45-100834-80	
	Stk	Crankcase Heater	N/A	44-101884-01	44-101884-01	

No.	Notes	MODEL COOLING CAPACITY VARIATION	RSG14 ALL ALL
ACCESORIES			
		Low Ambient Control	RXAD-A07
		Compressor Time Delay Control	RXMD-B01
		High Pressure Control	RXAB-A07
		Low Pressure Control	RXAC-A07

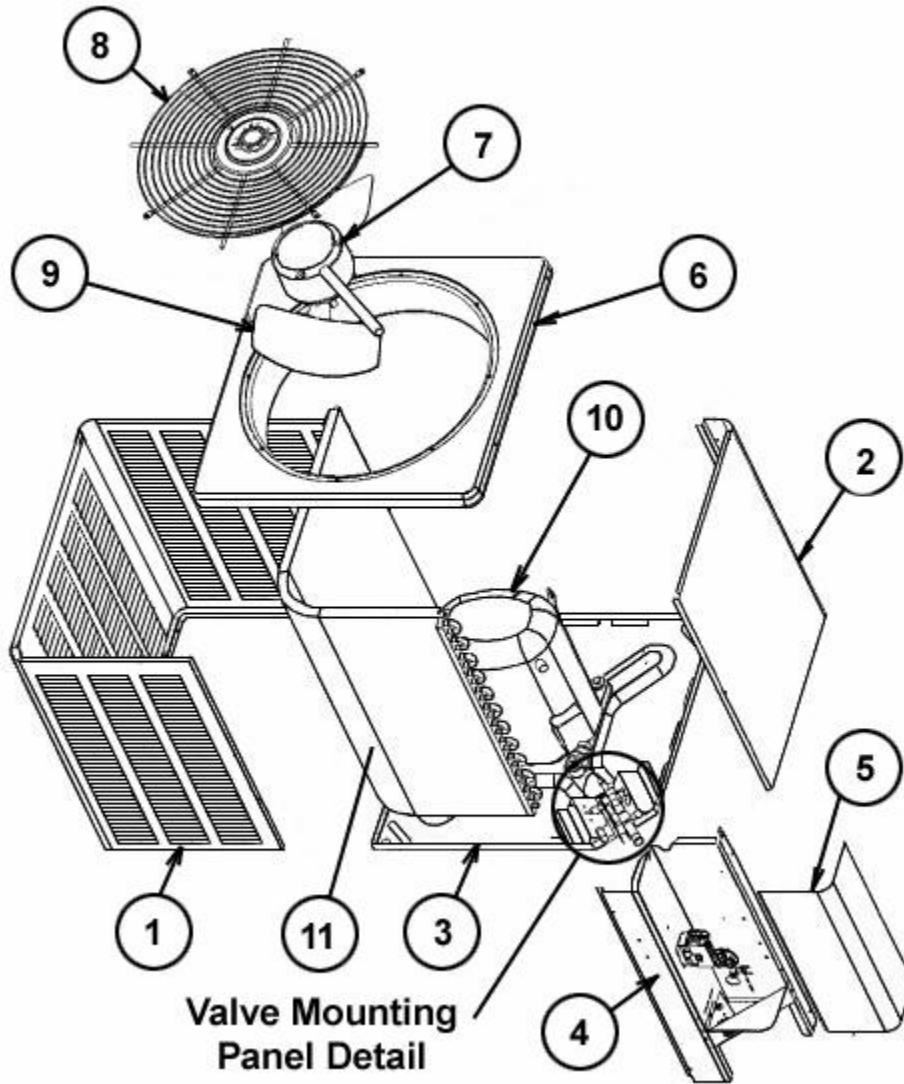

**Valve Mounting
Panel Detail**

Exploded View

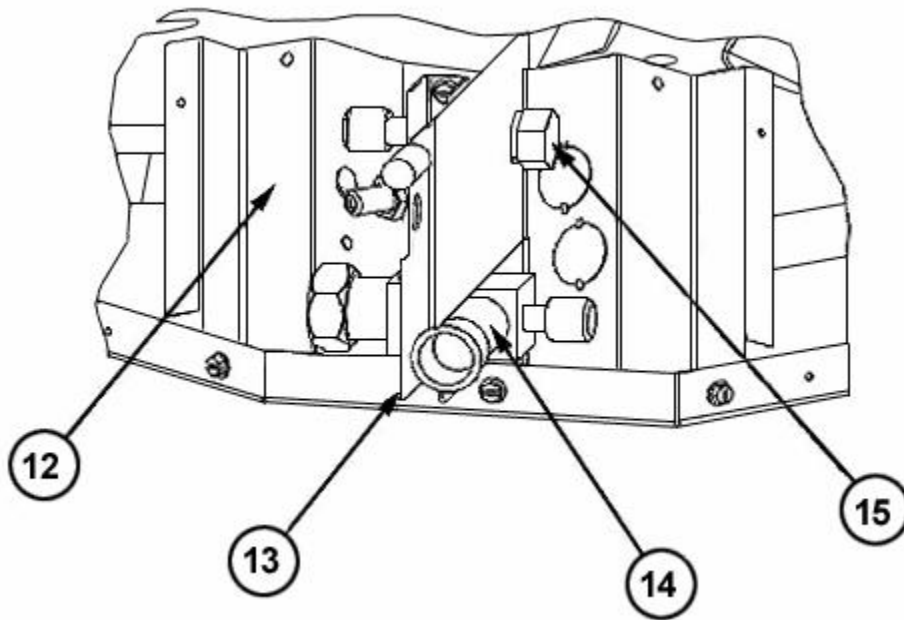

Valve Mounting Detail

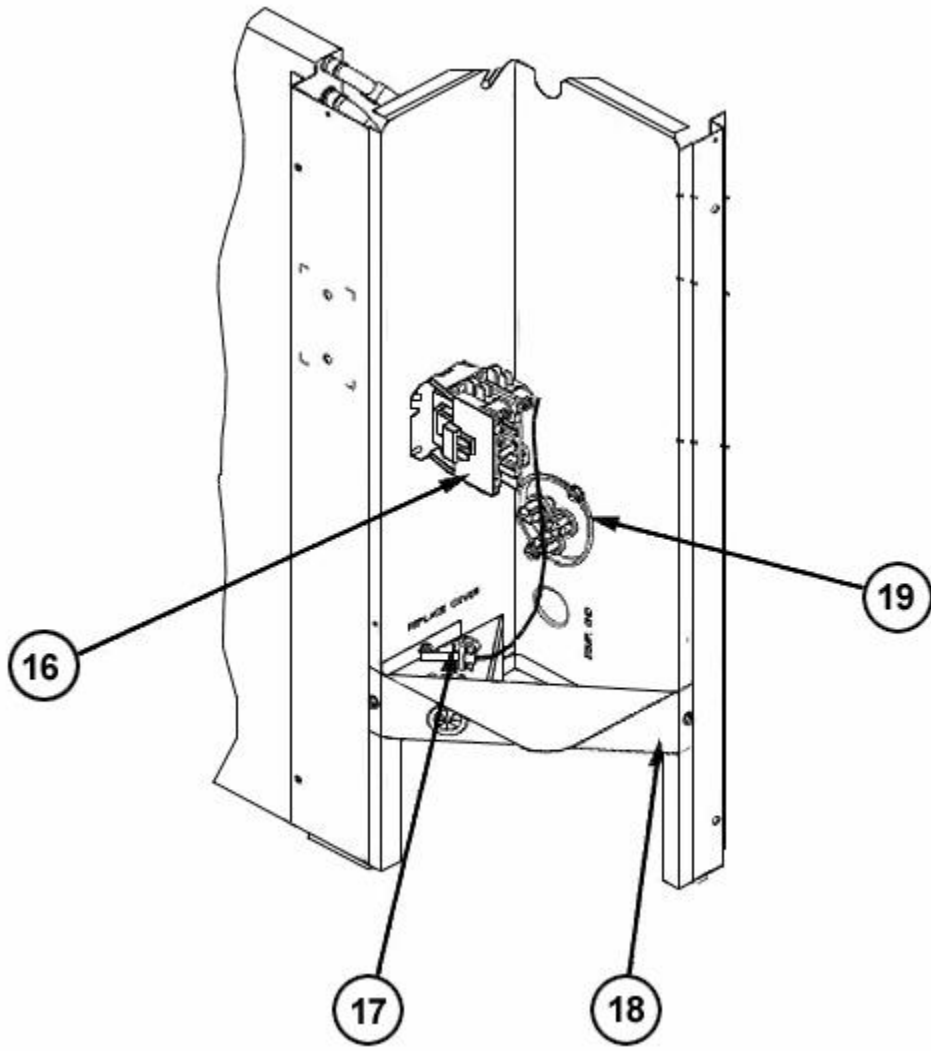

Control Box

NOTES

Stk It is recommended that stock be maintained for this part.

N/A Not Applicable

1 This compressor should be replaced with the designated Copleland scroll (55-102045 series) and the specified Retrofit Kit. USE OF THE RETROFIT KIT IS REQUIRED WHEN PERFORMING THIS REPLACEMENT. Failure to use the kit will greatly increase the likelihood of future compressor failure and will void the compressor warranty.