

This Owner's Manual is provided and hosted by [Appliance Factory Parts](#).



COMFORT-AIRE MAH36A-1K Owner's Manual

[Shop genuine replacement parts for COMFORT-AIRE
MAH36A-1K](#)



[Find Your COMFORT-AIRE HVAC Parts - Select From 1486 Models](#)

----- Manual continues below -----

HEAT CONTROLLER, INC.

MAH

Parts List
20-October-2011



This parts list is current as of the above revision date.

Form Number: 92-42810-MAH

Table of Contents

Model Explanation	Page 3
Parts Numbers	
Panels - Miscellaneous 024-036	Page 4
Panels - Miscellaneous 042-060	Page 5
Electrical Group	Page 6
Fan Group	Page 6
Blower Group	Page 7
Coil Parts	Page 8
Compressor Group	Page 9
Heater Kits	Page 10
Accessories	Page 10
Drawings/Photographs	
Exploded View	Page 11
Control Panel	Page 12
Blower Assembly	Page 13
Coil Assembly	Page 14
Notes	Page 15

MODEL NUMBER EXPLANATION

M	A	H	2	4	A	-	1	K
1			2		3			

- (1) **SERIES**
- (2) **COOLING CAPACITY (BTU/HR)**
 24= 24,000
 30= 30,000
 36= 36,000
 42= 42,000
 48= 48,000
 60= 60,000
- (3) **VARIATION**

SERIAL NUMBER EXPLANATION

7	0	9	2	F	0	7	0	1	9	9	9	9	9
1				2	3		4	5					

- (1) **COMPRESSOR IDENTIFICATION NUMBER**
- (2) **PRODUCTION LOCATION**
- (3) **WEEK OF PRODUCTION**
- (4) **YEAR OF PRODUCTION**
- (5) **PRODUCTION NUMBER**

No.	Notes	MODEL COOLING CAPACITY VARIATION	MAH 24 A-1K	MAH 30 A-1K	MAH 36 A-1K
PANELS, MISCELLANEOUS PARTS					
1		Louver Panel	AE-100830-22	AE-100830-22	AE-100830-22
2		Corner Post	AE-100822-21	AE-100822-21	AE-100822-21
3		Front Post	AE-100821-21	AE-100821-21	AE-100821-21
4		Louver Panel	AE-100830-21	AE-100830-21	AE-100830-21
5		Insulation Retainer	AE-100831-02	AE-100831-02	AE-100831-02
6		Front Access Panel	AE-100823-21	AE-100823-21	AE-100823-21
7	Stk	Drainpan	68-100808-01	68-100808-01	68-100808-01
8		Air Stop - Drainpan	AE-100825-01	AE-100825-01	AE-100825-01
9		Air Stop - Drainpan	AE-100825-02	AE-100825-02	AE-100825-02
10		Drainpan Tray	AE-100809-01	AE-100809-01	AE-100809-01
11		Control Access Panel	AE-100824-21	AE-100824-21	AE-100824-21
12		Control Panel Assembly	AS-100807-01	AS-100807-01	AS-100807-01
13		Base Rail (2)	AE-100803-02	AE-100803-02	AE-100803-02
14		Base Rail (2)	AE-100803-01	AE-100803-01	AE-100803-01
15		Base Pan	AE-100804-01	AE-100804-01	AE-100804-01
16		Right Panel Assembly	AS-100820-21	AS-100820-21	AS-100820-21
17		Blower Support	AE-100818-02	AE-100818-02	AE-100818-02
		Insulation Retainer (2)	AE-100831-01	AE-100831-01	AE-100831-01
		Duct Ring - 14 in.	58-100850-01	58-100850-01	58-100850-01
18		Transition Bottom	AE-100815-01	AE-100815-01	AE-100815-01
19		Transition Top	AE-100815-02	AE-100815-02	AE-100815-02
20		Block Off Plate	AE-100816-01	AE-100816-01	AE-100816-01
21		Rear Panel Assembly	AS-100814-21	AS-100814-21	AS-100814-21
22		Rear Air Stop	AE-100810-01	AE-100810-01	AE-100810-01
23		Top Panel Assembly (Indoor)	AS-100828-21	AS-100828-21	AS-100828-21
24		Top Panel (Outdoor)	AE-100829-21	AE-100829-21	AE-100829-21
25		Grille	95-100833-01	95-100833-01	95-100833-01
28		Blower Support	AE-100818-01	AE-100818-01	AE-100818-01
29		Bulkhead Cap Assembly	AS-100826-21	AS-100826-21	AS-100826-21
30		Bulkhead Assembly	AS-100812-01	AS-100812-01	AS-100812-01
37		Low Voltage Mount	AE-100839-01	AE-100839-01	AE-100839-01
38		Low Voltage Cover	AE-100839-02	AE-100839-02	AE-100839-02
43		Heater Kit Delete Plate (Mounted in Control Box)	AE-100842-01	AE-100842-01	AE-100842-01
49		Gaugeport Enclosure	AE-101352-01	AE-101352-01	AE-101352-01

No.	Notes	MODEL COOLING CAPACITY VARIATION	MAH 42 A-1K	MAH 48 A-1K	MAH 60 A-1K
PANELS, MISCELLANEOUS PARTS					
1		Louver Panel	AE-100830-22	AE-100830-24	AE-100830-24
2		Corner Post	AE-100822-21	AE-100822-22	AE-100822-22
3		Front Post	AE-100821-21	AE-100821-22	AE-100821-22
4		Louver Panel	AE-100830-21	AE-100830-23	AE-100830-23
5		Insulation Retainer	AE-100831-02	AE-100831-03	AE-100831-03
6		Front Access Panel	AE-100823-21	AE-100823-22	AE-100823-22
7	Stk	Drainpan	68-100808-01	68-100808-01	68-100808-01
8		Air Stop - Drainpan	AE-100825-01	AE-100825-01	AE-100825-01
9		Air Stop - Drainpan	AE-100825-02	AE-100825-02	AE-100825-02
10		Drainpan Tray	AE-100809-01	AE-100809-01	AE-100809-01
11		Control Access Panel	AE-100824-21	AE-100824-22	AE-100824-22
12		Control Panel Assembly	AS-100807-01	AS-100807-02	AS-100807-02
13		Base Rail (2)	AE-100803-02	AE-100803-02	AE-100803-02
14		Base Rail (2)	AE-100803-01	AE-100803-01	AE-100803-01
15		Base Pan	AE-100804-01	AE-100804-01	AE-100804-01
16		Right Panel Assembly	AS-100820-21	AS-100820-22	AS-100820-22
17		Blower Support	AE-100818-02	AE-100818-02	AE-100818-02
		Insulation Retainer (2)	AE-100831-01	AE-100831-01	AE-100831-01
		Duct Ring - 14 in.	58-100850-01	58-100850-01	58-100850-01
18		Transition Bottom	AE-100815-01	AE-100815-01	AE-100815-01
19		Transition Top	AE-100815-02	AE-100815-02	AE-100815-02
20		Block Off Plate	AE-100816-01	AE-100816-01	AE-100816-01
21		Rear Panel Assembly	AS-100814-21	AS-100814-22	AS-100814-22
22		Rear Air Stop	AE-100810-01	AE-100810-02	AE-100810-02
23		Top Panel Assembly (Indoor)	AS-100828-21	AS-100828-21	AS-100828-21
24		Top Panel (Outdoor)	AE-100829-21	AE-100829-21	AE-100829-21
25		Grille	95-100833-01	95-100833-01	95-100833-01
28		Blower Support	AE-100818-01	AE-100818-01	AE-100818-01
29		Bulkhead Cap Assembly	AS-100826-21	AS-100826-21	AS-100826-21
30		Bulkhead Assembly	AS-100812-01	AS-100812-02	AS-100812-02
37		Low Voltage Mount	AE-100839-01	AE-100839-01	AE-100839-01
38		Low Voltage Cover	AE-100839-02	AE-100839-02	AE-100839-02
43		Heater Kit Delete Plate (Mounted in Control Box)	AE-100842-01	AE-100842-01	AE-100842-01
49		Gaugeport Enclosure	AE-101352-01	AE-101352-01	AE-101352-01

No.	Notes	MODEL COOLING CAPACITY VARIATION	MAH 24 A-1K	MAH 30 A-1K	MAH 36 A-1K
ELECTRICAL GROUP					
CONTROL BOX COMPONENTS:					
39		Terminal Strip	45-23591-01	45-23591-01	45-23591-01
40	Stk	Transformer	46-100836-01	46-100836-01	46-100836-01
41	Stk	Blower Time Delay	47-23433-05	47-23433-05	47-23433-05
42	Stk	Relay	42-101208-01	42-101208-01	42-101208-01
44	Stk	Capacitor - Blower Motor	See Blower Group		
45		Capacitor Strap - Blower Motor Capacitor	AE-50892-01	AE-50892-01	AE-50892-01
46	Stk	Contactora	42-42728-03	42-42728-03	42-42728-03
47		Capacitor Strap - Compressor/Fan	AE-50892-56	AE-50892-56	AE-50892-56
48	Stk	Capacitor - Compressor/Fan	See Compressor Group		

No.	Notes	MODEL COOLING CAPACITY VARIATION	MAH 42 A-1K	MAH 48 A-1K	MAH 60 A-1K
ELECTRICAL GROUP					
CONTROL BOX COMPONENTS:					
39		Terminal Strip	45-23591-01	45-23591-01	45-23591-01
40	Stk	Transformer	46-100836-01	46-100836-01	46-100836-01
41	Stk	Blower Time Delay	47-23433-05	47-23433-05	47-23433-05
42	Stk	Relay	42-101208-01	42-101208-01	42-101208-01
44	Stk	Capacitor - Blower Motor	See Blower Group		
45		Capacitor Strap - Blower Motor Capacitor	AE-50892-01	AE-50892-01	AE-50892-01
46	Stk	Contactora	42-42728-03	42-42728-03	42-42478-02
47		Capacitor Strap - Compressor/Fan	AE-50892-56	AE-50892-56	AE-50892-56
48	Stk	Capacitor - Compressor/Fan	See Compressor Group		

No.	Notes	MODEL COOLING CAPACITY VARIATION	MAH 24 A-1K	MAH 30 A-1K	MAH 36 A-1K
FAN GROUP					
26	Stk	Fan Motor	51-100998-24	51-100998-24	51-100998-24
27	Stk	Fan Blade	70-100580-08	70-100580-08	70-100580-08
48		Capacitor - Fan Motor	See Compressor Group		

No.	Notes	MODEL COOLING CAPACITY VARIATION	MAH 42 A-1K	MAH 48 A-1K	MAH 60 A-1K
FAN GROUP					
26	Stk	Fan Motor	51-100998-24	51-100998-25	51-100998-25
27	Stk	Fan Blade	70-100580-08	70-100580-09	70-100580-09
48		Capacitor - Fan Motor	See Compressor Group		

No.	Notes	MODEL COOLING CAPACITY VARIATION	MAH 24 A-1K	MAH 30 A-1K	MAH 36 A-1K
BLOWER GROUP					
	Stk	Blower Assembly	AS-100841-01	AS-100841-02	AS-100841-03
51		Blower Housing w/Wheel	70-100840-01	70-100840-01	70-100840-01
	Stk	Blower Wheel	703017	703017	703017
52		Motor Band	70-19927-03	70-19927-03	70-19927-03
53		Blower Arm Assembly (3)	70-19929-09	70-19929-09	70-19929-09
54	Stk	Blower Motor	51-100837-01	51-100837-02	51-100837-03
44	Stk	Capacitor - Blower Motor	43-100497-09	43-100497-10	43-100497-46

No.	Notes	MODEL COOLING CAPACITY VARIATION	MAH 42 A-1K	MAH 48 A-1K	MAH 60 A-1K
BLOWER GROUP					
	Stk	Blower Assembly	AS-100841-04	AS-100841-05	AS-100841-06
51		Blower Housing w/Wheel	70-100840-02	70-100840-02	70-100840-02
	Stk	Blower Wheel	703016	703016	703016
52		Motor Band	70-19927-03	70-19927-03	70-19927-03
53		Blower Arm Assembly (3)	70-19929-09	70-19929-09	70-19929-09
54	Stk	Blower Motor	51-100837-04	51-100837-05	51-100837-06
44	Stk	Capacitor - Blower Motor	43-100497-42	43-100497-42	43-100497-49

No.	Notes	MODEL TECHNICAL VARIATION COOLING CAPACITY	MAH 24 A-1K	MAH 30 A-1K	MAH 36 A-1K
COIL GROUP					
CONDENSER COIL:					
32	Stk	Condenser Coil (Outdoor Coil)	AS-100793-05	AS-100793-05	AS-100793-07
EVAPORATOR COIL:					
33	Stk	Evaporator Coil (Indoor Coil)	AS-100792-06	AS-100792-07	AS-100792-08
7		Drain Pan - Evaporator Coil	See Panels - Miscellaneous		
34		Bulb Strainer	83-26020-02	83-26020-02	83-26020-02
35	Stk	TXV	61-101351-01	61-101351-02	61-101351-03
		TXV Bulb Strap Kit	64-101357-01	64-101357-01	64-101357-01
36		Draintrap Assembly	68-100846-01	68-100846-01	68-100846-01
REFRIGERATION GROUP:					
50		Gaugeport Manifold - Valve Body (2)	61-22369-04	61-22369-04	61-22369-04
50		Gaugeport Manifold - Valve Core (2)	61-18551-01	61-18551-01	61-18551-01

No.	Notes	MODEL TECHNICAL VARIATION COOLING CAPACITY	MAH 42 A-1K	MAH 48 A-1K	MAH 60 A-1K
COIL GROUP					
CONDENSER COIL:					
32	Stk	Condenser Coil (Outdoor Coil)	AS-100793-07	AS-100793-08	AS-100793-09
EVAPORATOR COIL:					
33	Stk	Evaporator Coil (Indoor Coil)	AS-100792-09	AS-100792-12	AS-100792-13
7		Drain Pan - Evaporator Coil	See Panels - Miscellaneous		
34		Bulb Strainer	83-26020-02	83-26020-02	83-26020-02
35	Stk	TXV	61-101351-04	61-101351-07	61-101351-06
		TXV Bulb Strap Kit	64-101357-01	64-101357-01	64-101357-01
36		Draintrap Assembly	68-100846-01	68-100846-01	68-100846-01
REFRIGERATION GROUP:					
50		Gaugeport Manifold - Valve Body (2)	61-22369-04	61-22369-04	61-22369-04
50		Gaugeport Manifold - Valve Core (2)	61-18551-01	61-18551-01	61-18551-01

No.	Notes	MODEL TECHNICAL VARIATION COOLING CAPACITY	MAH 24 A-1K	MAH 30 A-1K	MAH 36 A-1K
COMPRESSOR GROUP					
		Compressor ID:	7208	7210	7212
31	Stk	Compressor	55-100835-07S	55-100835-17S	55-100835-14S
48	Stk	Run Capacitor - Fan/Compressor	43-101665-44	43-26271-41	43-26271-41
55	Stk	Compressor Wiring Harness (Molded Plug)	45-100834-80	45-100834-80	45-100834-80

No.	Notes	MODEL TECHNICAL VARIATION COOLING CAPACITY	MAH 42 A-1K	MAH 48 A-1K	MAH 60 A-1K
COMPRESSOR GROUP					
		Compressor ID:	7213	7214	7215
31	Stk	Compressor	55-100835-15S	55-100835-04S	55-100835-18S
48	Stk	Run Capacitor - Fan/Compressor	43-26261-15	43-26271-38	43-26271-30
55	Stk	Compressor Wiring Harness (Molded Plug)	45-100834-80	45-100834-80	45-100834-80

No.	Notes	MODEL TECHNICAL VARIATION COOLING CAPACITY	MAH 24 A-1K	MAH 30 A-1K	MAH 36 A-1K
HEATER KITS					
		Heater Kit (5 kW)	RXQJ-C05J	RXQJ-C05J	RXQJ-C05J
		Heater Kit (7 kW)	RXQJ-C07J	RXQJ-C07J	RXQJ-C07J
		Heater Kit (10 kW)	RXQJ-C10J	RXQJ-C10J	RXQJ-C10J
		Heater Kit (15 kW)	N/A	RXQJ-C15J	RXQJ-C15J
		Heater Kit (20 kW)	N/A	N/A	N/A

No.	Notes	MODEL TECHNICAL VARIATION COOLING CAPACITY	MAH 42 A-1K	MAH 48 A-1K	MAH 60 A-1K
HEATER KITS					
		Heater Kit (5 kW)	RXQJ-C05J	RXQJ-C05J	RXQJ-C05J
		Heater Kit (7 kW)	RXQJ-C07J	RXQJ-C07J	RXQJ-C07J
		Heater Kit (10 kW)	RXQJ-C10J	RXQJ-C10J	RXQJ-C10J
		Heater Kit (15 kW)	RXQJ-C15J	RXQJ-C15J	RXQJ-C15J
		Heater Kit (20 kW)	RXQJ-C20J	RXQJ-C20J	RXQJ-C20J

No.	Notes	MODEL TECHNICAL VARIATION COOLING CAPACITY	MAH ALL ALL		
AACCESSORIES					
		Outdoor Thermostat	RXPT-A01		

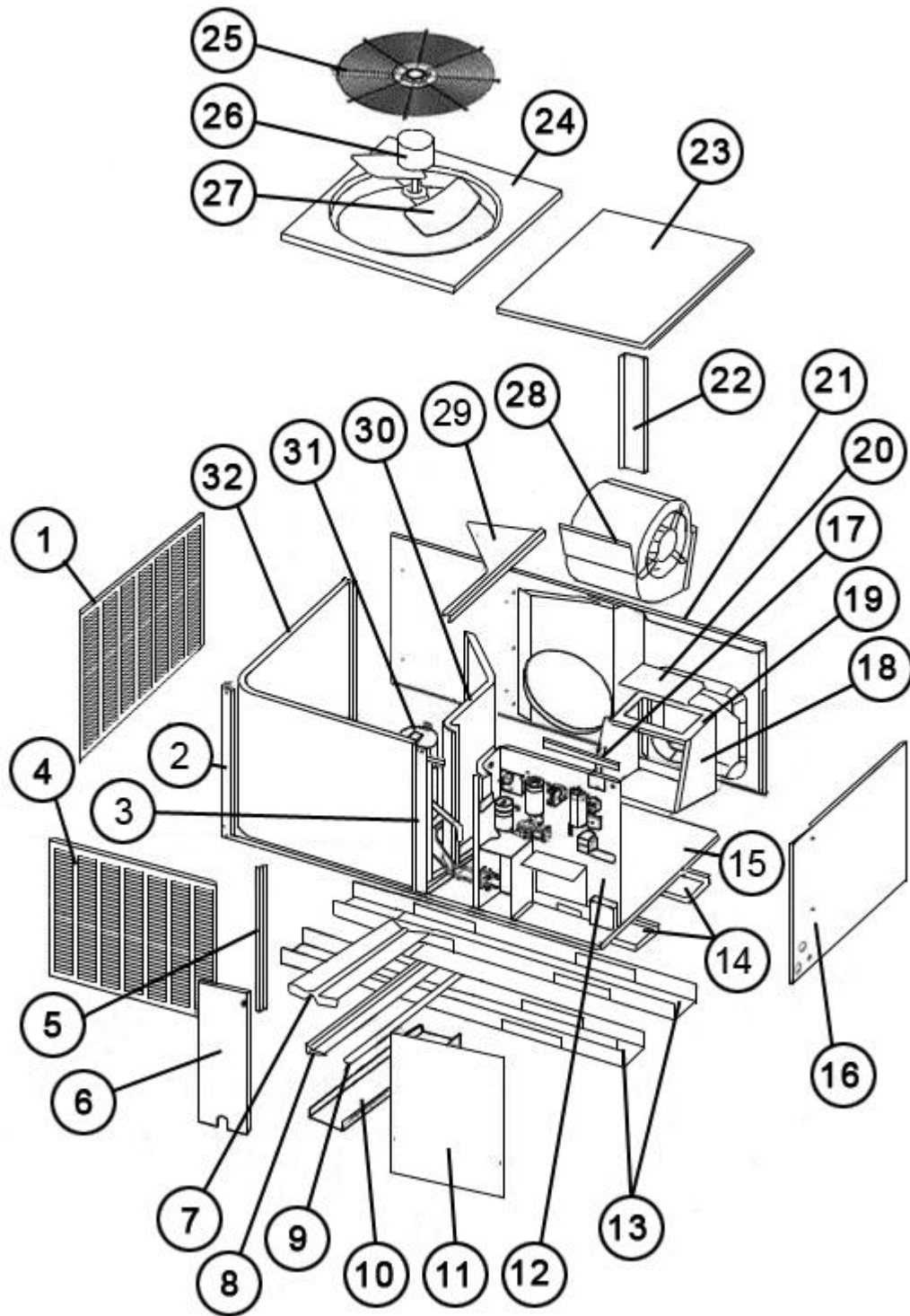

Exploded View

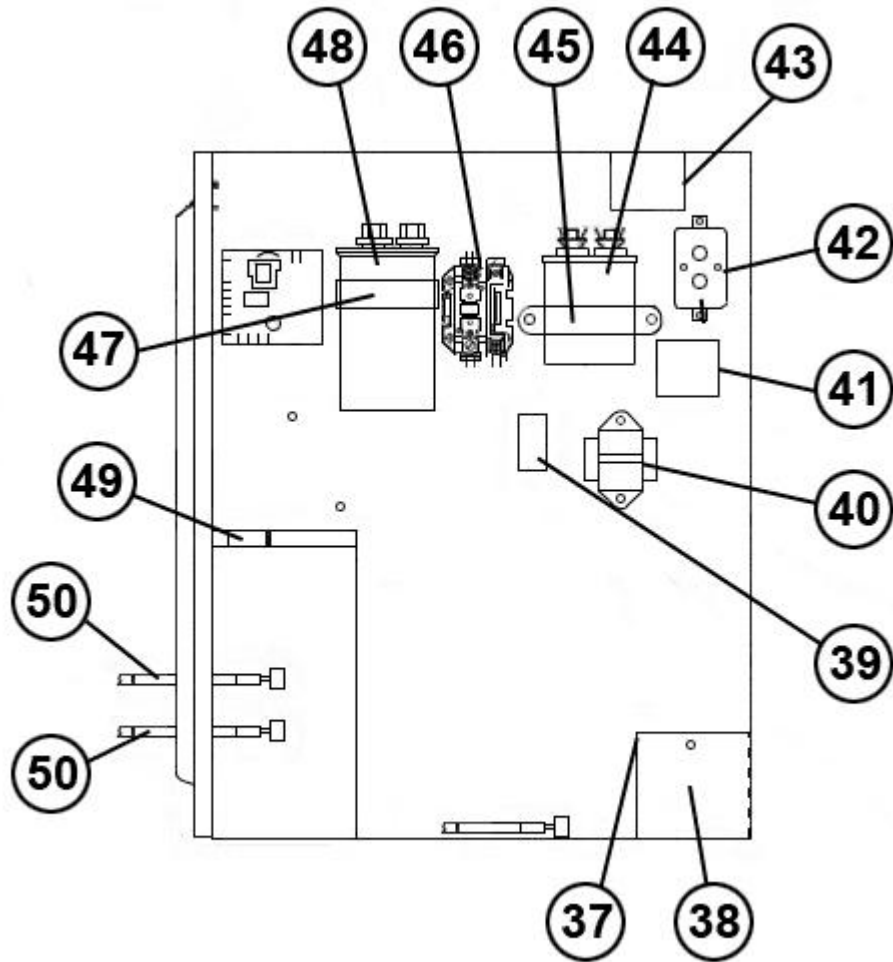

Control Panel

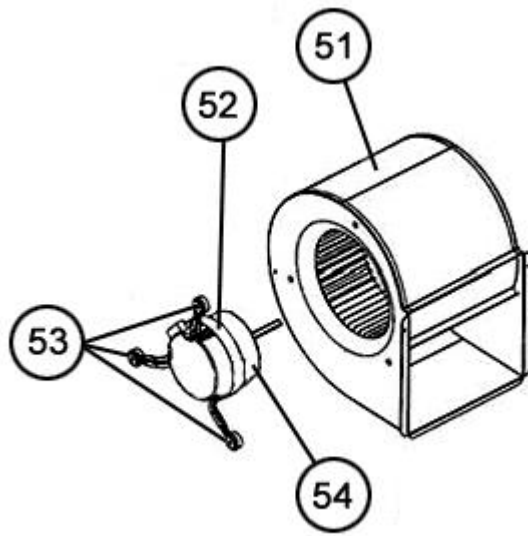

Blower Assembly

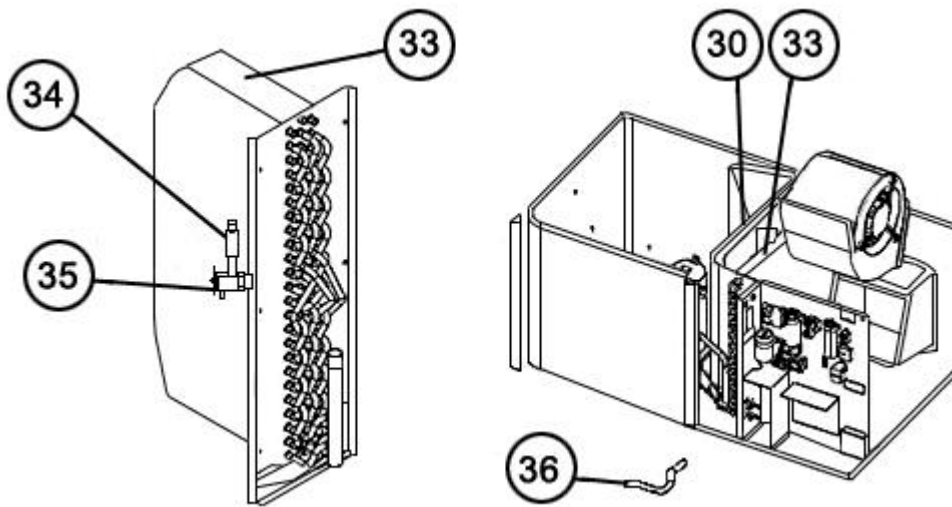

Coil Assembly

NOTES

Stk It is recommended that stock be maintained for this part.
N/A Not Applicable