

This Owner's Manual is provided and hosted by [Appliance Factory Parts](#).



# COMFORT-AIRE GTUV75E4B Owner's Manual

[Shop genuine replacement parts for COMFORT-AIRE  
GTUV75E4B](#)



[Find Your COMFORT-AIRE HVAC Parts - Select From 1486 Models](#)

----- Manual continues below -----

# GTUV-EB

HEAT CONTROLLER, INC.

Parts List  
17-March-2012



*This parts list is current as of the above revision date.*

Form Number: 92-42810-GTUV-EB

# Table of Contents

Model Explanation .....	Page 3
Parts Numbers	
Panels - Miscellaneous .....	Page 4
Panels - Miscellaneous (2) .....	Page 5
Electrical Group .....	Page 6
Blower Group .....	Page 7
Heat Exchanger-Burner Group .....	Page 8
Gas Controls .....	Page 8
Orifice Selection Chart .....	Page 9
Drawings/Photographs	
Exploded View .....	Page 10
Blower Assembly .....	Page 11
Burner Assembly .....	Page 12
Notes .....	Page 13

**MODEL NUMBER EXPLANATION**

<b>G</b>	<b>T</b>	<b>U</b>	<b>V</b>	<b>7</b>	<b>5</b>	<b>-</b>	<b>E</b>	<b>3</b>	<b>B</b>
<b>1</b>	<b>2</b>	<b>3</b>	<b>4</b>	<b>5</b>				<b>6</b>	

- (1) **GAS**
- (2) **95% - 2 Stage**
- (3) **UPFLOW CONDENSING**
- (4) **PLACEHOLDER**
- (5) **HEATING INPUT DESIGNATION**  
 Electric Ignition      Input BTU/HR  
 45                            =    45,000  
 60                            =    60,000  
 75                            =    75,000  
 90                            =    90,000  
 10                            =    105,000  
 12                            =    120,000
- (6) **VARIATION**

**SERIAL NUMBER EXPLANATION**

<b>H</b>	<b>J</b>	<b>5</b>	<b>D</b>	<b>7</b>	<b>0</b>	<b>7</b>	<b>F</b>	<b>3</b>	<b>1</b>	<b>0</b>	<b>8</b>	<b>9</b>	<b>9</b>	<b>9</b>	<b>9</b>
(1)		(2)	(3)	(4)	(5)	(6)	(7)	(8)		(9)				(10)	

- (1) **GAS CODE**
- (2) **LIMIT CONTROL**
- (3) **BLOWER**
- (4) **HEATING ELEMENT**
- (5) **SPECIAL AREA REQUIREMENT**
- (6) **MOTOR HORSEPOWER**
- (7) **PLANT**
- (8) **WEEK**
- (9) **YEAR**
- (10) **PRODUCTION NUMBER**

No.	Notes	MODEL HEATING CAPACITY VARIATIONS	GTUV 45 E3B	GTUV 60 E3B	GTUV 75 E3B	GTUV 75 E4B	GTUV 90 E5B
<b>PANELS, SHEET METAL, MISCELLANEOUS</b>							
1		Jacket	AS-61824-25	AS-61824-25	AS-61824-25	AS-61824-27	AS-61824-26
4		Outlet Air Pipe	68-24021-01	68-24021-01	68-24021-01	68-24021-03	68-24021-01
5		Gasket - Outlet Air Pipe	68-24022-02	68-24022-02	68-24022-02	68-24022-02	68-24022-02
6		Top Plate	AS-61872-01	AS-61872-01	AS-61872-01	AS-61872-02	AS-61872-02
7		Locknut - Fresh Air Damper	64-24031-01	64-24031-01	64-24031-01	64-24031-01	64-24031-01
8		Burner Door	AS-61866-09	AS-61866-09	AS-61866-09	AS-61867-09	AS-61867-09
9		Blower/Filter Door	AS-67890-11	AS-67890-11	AS-67890-11	AS-67891-11	AS-67891-11
10		Filter - Plastic	54-24094-01	54-24094-01	54-24094-01	54-24094-02	54-24094-02
		Filter Retainer Rod	45-24095-01	45-24095-01	45-24095-01	45-24095-01	45-24095-01
		Filter Rod Support Angle	AE-60520-01	AE-60520-01	AE-60520-01	AE-60520-01	AE-60520-01
		Filter Support Angle	AE-61883-01	AE-61883-01	AE-61883-01	AE-61883-01	AE-61883-01
11		Solid Bottom	AE-61874-02	AE-61874-02	AE-61874-02	AE-61874-03	AE-61874-03
A		Button Plug - 2 in. opening	45-22980-08	45-22980-08	45-22980-08	45-22980-08	45-22980-08
B		Button Plug (2) - 2-3/8 in. opening	45-22980-03	45-22980-03	45-22980-03	45-22980-03	45-22980-03
12		Pressure Switch Assembly	See Electrical Group				
		Silicon Tubing - Pressure Switch	AE-61737-10	AE-61737-10	AE-61737-10	AE-61737-10	AE-61737-10
13		Trap / Elbow Assembly	68-100651-01	68-100651-01	68-100651-01	68-100651-01	68-100651-01
14		Water Trap Mount Bracket	AE-61841-01	AE-61841-01	AE-61841-01	AE-61841-01	AE-61841-01
15		Junction Box Cover	AE-61476-02	AE-61476-02	AE-61476-02	AE-61476-02	AE-61476-02
16		Door Switch (Push Button)	See Electrical Group				
17		Junction Box	AE-61475-02	AE-61475-02	AE-61475-02	AE-61475-02	AE-61475-02
		Grommet (5/8 in. Tube)	56-22521-03	56-22521-03	56-22521-03	56-22521-03	56-22521-03
		Grommet (1/2 in. I.D.)	56-24008-01	56-24008-01	56-24008-01	56-24008-01	56-24008-01
		Grommet (1/4 in. I.D.)	56-24008-02	56-24008-02	56-24008-02	56-24008-02	56-24008-02
		Grommet (2 in. opening)	56-22114-06	56-22114-06	56-22114-06	56-22114-06	56-22114-06
28		Heat Exchanger	See Heat Exchanger Group				
29		Limit - Main Limit (Heat Exchanger Panel)	See Electrical Group				
30		Connector/Transition	68-24047-07	68-24047-07	68-103061-01	68-24047-08	68-24047-08
31		Induced Draft Blower w/Gasket	See Electrical Group				
		Tubing (1/2 in. I.D.) - Includes Two Hose Clamps (3)	79-25353-82	79-25353-82	79-25353-82	79-25353-82	79-25353-82
		Tubing Drain Trap (Induced Draft Blower - Includes two Hose Clamps)	791000	791000	791000	791001	791001
		Elbow (Induced Draft Blower - 1/2 in. barbed)	68-24013-01	68-24013-01	68-24013-01	68-24013-01	68-24013-01

No.	Notes	MODEL HEATING CAPACITY VARIATIONS	GTUV ALL ALL				
<b>PARTS BAG</b>							
		Complete Parts Bag	AS-100717-01				
2		O-Ring - Fresh Air Damper	68-24032-01				
3		Adapter - Fresh Air Damper and Locknut	68-24114-01				
		1/2 in. Tee	68-21980-02				
		1/2 in. PVC Pipe - 4 in.	68-22024-04				
		Plug - Nylon - 7/8 in.	45-22926-01				
		Plug - Nylon 1-1/8 in.	45-22926-02				
		PVC Vane	68-23473-01				
		PVC Wind Vane - 2-1/2 in.	68-24049-01				
		Hose Clamp	64-22043-01				
		Hose Clamp (2)	64-22043-02				

No.	Notes	MODEL HEATING CAPACITY VARIATIONS	GTUV 10 E5B	GTUV 12 E5B			
<b>PANELS, SHEET METAL, MISCELLANEOUS</b>							
1		Jacket	AS-61824-26	AS-61824-28			
4		Outlet Air Pipe	68-24021-01	68-24021-01			
5		Gasket - Outlet Air Pipe	68-24022-02	68-24022-02			
6		Top Plate	AS-61872-02	AS-61872-03			
7		Locknut - Fresh Air Damper	64-24031-01	64-24031-01			
8		Burner Door	AS-61867-09	AS-61868-09			
9		Blower/Filter Door	AS-67891-11	AS-67892-11			
10		Filter - Plastic	54-24094-02	54-24094-03			
		Filter Retainer Rod	45-24095-01	45-24095-01			
		Filter Rod Support Angle	AE-60520-01	AE-60520-01			
		Filter Support Angle	AE-61883-01	AE-61883-01			
11		Solid Bottom	AE-61874-03	AE-61874-04			
A		Button Plug - 2 in. opening	45-22980-08	45-22980-08			
B		Button Plug (2) - 2-3/8 in. opening	45-22980-03	45-22980-03			
12		Pressure Switch Assembly			See Electrical Group		
		Silicon Tubing - Pressure Switch	AE-61737-10	AE-61737-10			
13		Trap / Elbow Assembly	68-100651-01	68-100651-01			
14		Water Trap Mount Bracket	AE-61841-01	AE-61841-01			
15		Junction Box Cover	AE-61476-02	AE-61476-02			
16		Door Switch (Push Button)			See Electrical Group		
17		Junction Box	AE-61475-02	AE-61475-02			
		Grommet (5/8 in. Tube)	56-22521-03	56-22521-03			
		Grommet (1/2 in. I.D.)	56-24008-01	56-24008-01			
		Grommet (1/4 in. I.D.)	56-24008-02	56-24008-02			
		Grommet (2 in. opening)	56-22114-06	56-22114-06			
28		Heat Exchanger			See Heat Exchanger Group		
29		Limit - Main Limit (Heat Exchanger Panel)			See Electrical Group		
30		Connector/Transition	68-24047-08	68-24047-09			
31		Induced Draft Blower w/Gasket			See Electrical Group		
		Tubing (1/2 in. I.D.) - Includes Two Hose Clamps (3)	79-25353-82	79-25353-82			
		Tubing Drain Trap (Induced Draft Blower - Includes two Hose Clamps)	791000	791000			
		Elbow (Induced Draft Blower - 1/2 in. barbed)	68-24013-01	68-24013-01			

No.	Notes	MODEL HEATING CAPACITY VARIATIONS	GTUV ALL ALL				
<b>PARTS BAG</b>							
		Complete Parts Bag	AS-100717-01				
2		O-Ring - Fresh Air Damper	68-24032-01				
3		Adapter - Fresh Air Damper and Locknut	68-24114-01				
		1/2 in. Tee	68-21980-02				
		1/2 in. PVC Pipe - 4 in.	68-22024-04				
		Plug - Nylon - 7/8 in.	45-22926-01				
		Plug - Nylon 1-1/8 in.	45-22926-02				
		PVC Vane	68-23473-01				
		PVC Wind Vane - 2-1/2 in.	68-24049-01				
		Hose Clamp	64-22043-01				
		Hose Clamp (2)	64-22043-02				

No.	Notes	MODEL HEATING CAPACITY VARIATIONS	GTUV 45 E3B	GTUV 60 E3B	GTUV 75 E3B	GTUV 75 E4B	GTUV 90 E5B
<b>ELECTRICAL GROUP</b>							
12	Stk	Pressure Switch Assembly - Before F3010	42-102056-01	42-102056-06	42-102056-13	42-102056-02	42-102056-03
12	Stk	Pressure Switch Assembly - After F3010	42-102056-01	42-102056-06	42-102056-22	42-102056-02	42-102056-03
12	Stk	Pressure Switch Assembly - Option 278	N/A	N/A	N/A	N/A	N/A
16		Door Switch (Push Button)	42-22692-02	42-22692-02	42-22692-02	42-22692-02	42-22692-02
19	Stk	Transformer	46-24124-03	46-24124-03	46-24124-03	46-24124-03	46-24124-03
21		Integrated Furnace Control Board (IFC)	See Gas Controls				
26	Stk	Choke - Power Factor	46-24256-02	46-24256-02	46-24256-02	46-24256-02	46-24256-02
29	Stk	Limit - Main Limit (Heat Exchanger Panel)	47-25350-06	47-25350-05	47-25350-09	47-25350-07	47-25350-07
34a	Stk	Limit - Manual Reset (Burner Compartment)	47-22861-02 (1)	47-22861-02 (1)	47-22861-02 (2)	47-22861-02 (2)	47-22861-02 (2)
31	Stk,3	Induced Draft Blower w/Gasket - See Note 3	70-100612-03	70-100612-03	70-100612-03	70-100612-03	70-100612-03
		Gasket - Induced Draft Blower	68-24016-01	68-24016-01	68-24016-01	68-24016-01	68-24016-01
	Stk,3	Capacitor - Induced Draft Blower (Before F3010) - See Note 3	43-100496-03	43-100496-03	43-100496-03	43-100496-03	43-100496-03
	Stk,3	Capacitor - Induced Draft Blower (After F3010) - See Note 3	43-25134-35	43-25134-35	43-25134-35	43-25134-35	43-25134-35
		Twist Lock Wiring Harnesses - 15 pin to (5 pin/3 pin/6 terminals), 14 wires from 15 pin (Before F3010)	45-24393-06	45-24393-06	45-24393-06	45-24393-06	45-24393-06
		Twist Lock Wiring Harnesses - 15 pin to (5 pin/3 pin/6 terminals), 12 wires from 15 pin (After F3010)	45-24393-08	45-24393-08	45-24393-08	45-24393-08	45-24393-08
		Wiring Harnesses - 2 pin to quick connect and strip lead	45-24371-37	45-24371-37	45-24371-37	45-24371-37	45-24371-37
		Wiring Harnesses - 5 pin to two (2 pin connectors)	45-102643-01	45-102643-01	45-102643-01	45-102643-01	45-102643-01
		Wiring Harnesses - 16 pin to 16 pin	45-102641-01	45-102641-01	45-102641-01	45-102641-01	45-102641-01
		Wiring Harnesses - 15 pin to (12 pin/3 pin/2 flag terminals), 14 wires from 15 pin (Before F3010)	45-102667-01	45-102667-01	45-102667-01	45-102667-01	45-102667-01
		Wiring Harnesses - 15 pin to (12 pin and 3 pin), 12 wires from 15 pin (After F3010)	45-102667-03	45-102667-03	45-102667-03	45-102667-03	45-102667-03
		Wiring Harness - 6 pin to (2 pin/2 flag terminals), 4 wires from 6 pin	See Gas Controls				

No.	Notes	MODEL HEATING CAPACITY VARIATIONS	GTUV 10 E5B	GTUV 12 E5B			
<b>ELECTRICAL GROUP</b>							
12	Stk	Pressure Switch Assembly - Before F3010	42-103193-01	42-102056-05			
12	Stk	Pressure Switch Assembly - After F3010	42-102056-01	42-102056-05			
12	Stk	Pressure Switch Assembly - Option 278	N/A	N/A			
16		Door Switch (Push Button)	42-22692-02	42-22692-02			
19	Stk	Transformer	46-24124-03	46-24124-03			
21		Integrated Furnace Control Board (IFC)	See Gas Controls				
26	Stk	Choke - Power Factor	46-24256-02	46-24256-02			
29	Stk	Limit - Main Limit (Heat Exchanger Panel)	47-25350-06	47-25350-01			
34a	Stk	Limit - Manual Reset (Burner Compartment)	47-22861-02 (2)	47-22861-02 (3)			
31	Stk,3	Induced Draft Blower w/Gasket - See Note 3	70-100612-03	70-100612-03			
		Gasket - Induced Draft Blower	68-24016-01	68-24016-01			
	Stk,3	Capacitor - Induced Draft Blower (Before F3010) - See Note 3	43-100496-03	43-100496-03			
	Stk,3	Capacitor - Induced Draft Blower (After F3010) - See Note 3	43-25134-35	43-25134-35			
		Twist Lock Wiring Harnesses - 15 pin to (5 pin/3 pin/6 terminals), 14 wires from 15 pin (Before F3010)	45-24393-06	45-24393-06			
		Twist Lock Wiring Harnesses - 15 pin to (5 pin/3 pin/6 terminals), 12 wires from 15 pin (After F3010)	45-24393-08	45-24393-08			
		Wiring Harnesses - 2 pin to quick connect and strip lead	45-24371-37	45-24371-37			
		Wiring Harnesses - 5 pin to two (2 pin connectors)	45-102643-01	45-102643-01			
		Wiring Harnesses - 16 pin to 16 pin	45-102641-01	45-102641-01			
		Wiring Harnesses - 15 pin to (12 pin/3 pin/2 flag terminals), 14 wires from 15 pin (Before F3010)	45-102667-01	45-102667-01			
		Wiring Harnesses - 15 pin to (12 pin and 3 pin), 12 wires from 15 pin (After F3010)	45-102667-03	45-102667-03			
		Wiring Harness - 6 pin to (2 pin/2 flag terminals), 4 wires from 6 pin	See Gas Controls				

No.	Notes	MODEL HEATING CAPACITY VARIATIONS	GTUV 45 E3B	GTUV 60 E3B	GTUV 75 E3B	GTUV 75 E4B
<b>BLOWER GROUP</b>						
18	Stk	Blower Assembly (Includes items 22-25, 27)	AS-67876-44	AS-67876-45	AS-67876-46	AS-67876-47
19		Transformer w/Fuse	See Electrical Group			
20		Mounting Plate - Control	AE-67877-01	AE-67877-01	AE-67877-01	AE-67877-01
21		Integrated Furnace Control Board (IFC)	See Gas Controls			
22	Stk	Thermistor - Return Air Sensor	N/A	N/A	N/A	N/A
23		Housing	AS-61674-02	AS-61674-02	AS-61674-02	AS-61674-02
24	Stk	Blower Motor - ECM	51-24374-26	51-24374-27	51-24374-28	51-24376-23
		Motor Mount Kit (Grommets, Screws, Nuts, Belly Band, Brackets)	70-24104-82	70-24104-82	70-24104-82	70-24104-82
		ECM Motor Mount (Belly Band)	70-24104-02	70-24104-02	70-24104-02	70-24104-02
25		Motor Mount Bracket (4)	AE-61956-01	AE-61956-01	AE-61956-01	AE-61956-01
26		Choke - Power Factor	See Electrical Group			
27	Stk	Blower Wheel	70-24254-02	70-24254-02	70-24254-02	70-103207-01

No.	Notes	MODEL HEATING CAPACITY VARIATIONS	GTUV 90 E5B	GTUV 90 E5B	GTUV 10 E5B	GTUV 10 E5B
<b>BLOWER GROUP</b>						
18	Stk,4	Blower Assembly (Includes items 22-25, 27) - See Note 4	AS-67876-48 (Before F1112)	AS-67876-67 (After F1112)	AS-67876-49 (Before F1112)	AS-67876-68 (After F1112)
19		Transformer w/Fuse	See Electrical Group			
20		Mounting Plate - Control	AE-67877-01	AE-67877-01	AE-67877-01	AE-67877-01
21		Integrated Furnace Control Board (IFC)	See Gas Controls			
22	Stk	Thermistor - Return Air Sensor	N/A	N/A	N/A	N/A
23		Housing	AS-61674-08	AS-61674-08	AS-61674-08	AS-61674-08
24	Stk,4	Blower Motor - ECM (See Note 4)	51-24376-24 (Before F1112)	51-24376-30 (After F1112)	51-24376-25 (Before F1112)	51-24376-29 (After F1112)
		Motor Mount Kit (Grommets, Screws, Nuts, Belly Band, Brackets)	70-24104-82	70-24104-82	70-24104-82	70-24104-82
		ECM Motor Mount (Belly Band)	70-24104-02	70-24104-02	70-24104-02	70-24104-02
25		Motor Mount Bracket (4)	AE-61956-01	AE-61956-01	AE-61956-01	AE-61956-01
26		Choke - Power Factor	See Electrical Group			
27	Stk,4	Blower Wheel (See Note 4)	70-24179-01 (Before F1112)	70-23111-20 (After F1112)	70-24179-01 (Before F1112)	70-23111-20 (After F1112)

No.	Notes	MODEL HEATING CAPACITY VARIATIONS	GTUV 12 E5B			
<b>BLOWER GROUP</b>						
18	Stk	Blower Assembly (Includes items 22-25, 27)	AS-67876-50			
19		Transformer w/Fuse	See Electrical Group			
20		Mounting Plate - Control	AE-67877-01			
21		Integrated Furnace Control Board (IFC)	See Gas Controls			
22	Stk	Thermistor - Return Air Sensor	N/A			
23		Housing	AS-61674-03			
24	Stk	Blower Motor - ECM	51-24376-26			
		Motor Mount Kit (Grommets, Screws, Nuts, Belly Band, Brackets)	70-24104-82			
		ECM Motor Mount (Belly Band)	70-24104-02			
25		Motor Mount Bracket (4)	AE-61956-01			
26		Choke - Power Factor	See Electrical Group			
27	Stk	Blower Wheel	70-23111-20			

No.	Notes	MODEL HEATING CAPACITY VARIATIONS	GTUV 45 E3B	GTUV 60 E3B	GTUV 75 E3B	GTUV 75 E4B	GTUV 90 E5B	
<b>HEAT EXCHANGER, BURNER / MANIFOLD</b>								
28	Stk	Heat Exchanger	AS-61805-29	AS-61805-30	AS-61805-36	AS-61805-33	AS-61805-32	
29		Limit - Main Limit (Heat Exchanger Panel)	See Electrical Group					
31		Induced Draft Blower w/Gasket	See Electrical Group					
32	Stk	Burner Assembly	AS-61984-03	AS-61984-04	AS-61984-05	AS-61984-05	AS-61984-06	
33		Burner Diffuser	AE-61882-12	AE-61882-11	AE-61882-07	AE-61882-07	AE-61882-08	
34a		Limit - Manual Reset (Burner Compartment)	See Electrical Group					
34b		Bracket - Limit Control	AE-61913-02	AE-61913-02	AE-61913-02 (2)	AE-61913-02 (2)	AE-61913-02 (2)	
35		Burner Shield	AE-61807-01	AE-61807-02	AE-61807-03	AE-61807-03	AE-61807-04	
36	Stk	Manifold (w/o Orifices)	81-24395-01	81-24395-02	81-24395-03	81-24395-03	81-24395-04	
		NOX Burner Inserts	AE-67863-01 (2)	AE-67863-01 (3)	AE-67863-01 (4)	AE-67863-01 (4)	AE-67863-01 (5)	
		NOX Retaining Bracket	AE-67864-06	AE-67864-01	AE-67864-02	AE-67864-02	AE-67864-03	
37		Burner Orifice - Natural Gas	See Orifice Selection Chart					
37		Burner Orifice - LP	See Orifice Selection Chart					
		Number of Orifices	(3)	(4)	(5)	(5)	(6)	
41		Burner Support	AE-61809-11	AE-61809-12	AE-61809-13	AE-61809-13	AE-61809-14	
42		Burner Support Bracket (2)	AE-61808-01	AE-61808-01	AE-61808-01	AE-61808-01	AE-61808-01	

No.	Notes	MODEL HEATING CAPACITY VARIATIONS	GTUV 10 E5B	GTUV 12 E5B				
<b>HEAT EXCHANGER, BURNER / MANIFOLD</b>								
28	Stk	Heat Exchanger	AS-103085-01	AS-61805-35				
29		Limit - Main Limit (Heat Exchanger Panel)	See Electrical Group					
31		Induced Draft Blower w/Gasket	See Electrical Group					
32	Stk	Burner Assembly	AS-61984-07	AS-61984-08				
33		Burner Diffuser	AE-61882-09	AE-61882-10				
34a		Limit - Manual Reset (Burner Compartment)	See Electrical Group					
34b		Bracket - Limit Control	AE-61913-02 (2)	AE-61913-02 (2)				
35		Burner Shield	AE-61807-05	AE-61807-06				
36	Stk	Manifold (w/o Orifices)	81-24395-05	81-24395-06				
		NOX Burner Inserts	AE-67863-01 (6)	AE-67863-01 (7)				
		NOX Retaining Bracket	AE-67864-04	AE-67864-05				
37		Burner Orifice - Natural Gas	See Orifice Selection Chart					
37		Burner Orifice - LP	See Orifice Selection Chart					
		Number of Orifices	(7)	(8)				
41		Burner Support	AE-61809-15	AE-61809-16				
42		Burner Support Bracket (2)	AE-61808-01	AE-61808-01				

No.	Notes	MODEL GAS CODE	GTUV HJ	GTUV HK			
<b>GAS CONTROLS</b>							
21	Stk	Integrated Furnace Control Board (IFC)	62-103189-01	62-103189-01			
38	Stk	Gas Valve - Natural Gas	60-24394-01	60-101921-01			
38	Stk	Gas Valve - LP	See Note 2	See Note 1			
39	Stk	Flame Sensor	62-23543-01	62-23543-01			
40	Stk	Ignitor - Direct Spark	62-24141-04	62-24141-04			
		Bracket - Direct Spark	AE-61885-02	AE-61885-02			
	Stk	LP Conversion Kit - USA	FP-26	FP-21			
	Stk	LP Conversion Kit - Canada	FP-26	FP-21			
		Wiring Harness - 6 pin to (2 pin/2 flag terminals), 4 wires from 6 pin	N/A	N/A			

**90% GAS FURNACE - ORIFICE SELECTION CHART - NATURAL GAS**

**CAUTION:** Selection of the correct Natural Gas Orifice requires the following information for the specific installation:

1) Altitude in of the installation (ft.).

2) Average energy content of the Natural Gas fuel from the local supplier (BTU/cu. ft.).

For detailed information and instructions for Orifice selection, see the Gas Furnace LP Conversion Kit Index 92-21519-59 and the latest edition of the National Fuel Gas Code Handbook, or the National Standard of Canada, Natural Gas and Propane Installation Code, CAN B149.1.

**CAUTION:** This information is provided for replacement purposes only. Conversion for operation at High Altitude must be done using the kit specified on the product specification sheet for the unit.

NOTE: This Orifice sizing chart is based on 15,000 BTU/HR per burner.

NOTE: Factory installed orifices are calculated and sized based on a Natural Gas heating value of 1075 BTU/cu. ft. and an elevation of 0 - 2000 ft.

Energy Value (BTU/cu. ft.)	Elevation (ft.)							
	0 - 1999	2000 - 2999	3000 - 3999	4000 - 4999	5000 - 5999	6000 - 6999	7000 - 7999	8000 - 8999
<b>850</b>	62-22175-47	62-22175-48	62-22175-48	62-22175-49	62-22175-49	62-22175-49	62-22175-50	62-22175-50
<b>900</b>	62-22175-48	62-22175-49	62-22175-49	62-22175-49	62-22175-50	62-22175-50	62-22175-50	62-22175-51
<b>975</b>	62-22175-49	62-22175-50	62-22175-50	62-22175-50	62-22175-51	62-22175-51	62-22175-51	62-22175-52
<b>1075</b>	62-22175-50	62-22175-51	62-22175-51	62-22175-51	62-22175-51	62-22175-52	62-22175-52	62-22175-52
<b>1170</b>	62-22175-51	62-22175-51	62-22175-52	62-22175-52	62-22175-52	62-22175-53	62-22175-53	62-22175-53

**90% GAS FURNACE - ORIFICE SELECTION CHART - LP**

**CAUTION:** Selection of the correct LP Orifice requires the altitude of the specific installation (ft.).

For detailed information and instructions for Orifice selection, see the Gas Furnace LP Conversion Kit Index 92-21519-59 and the latest edition of the National Fuel Gas Code Handbook (NFG), or the National Standard of Canada, Natural Gas and Propane Installation Code, CAN B149.1.

**CAUTION:** This information is provided for replacement purposes only. Conversion to LP or for operation at High Altitude should be done using the kit(s) specified on the product specification sheet for the unit.

NOTE: This Orifice sizing chart is based on 15,000 BTU/HR per burner. Also, the chart is developed using the specified pressure setting of 10 in. water column instead of the 11.0 in water column used by the NFG and CANB149.1.

NOTE: Orifices supplied in the LP Conversion Kit are calculated and sized based on an altitude of 0 - 2000 ft.

Elevation (ft.)	Orifice							
0 to 2000 ft.	62-22175-91							
2001 to 3000	62-22175-91							
3001 to 4000	62-22175-90							
4001 to 5000	62-22175-58							
5001 to 6000	62-22175-59							
6001 to 7000	62-22175-60							
7001 to 8000	62-22175-62							
8001 to 9000	62-22175-63							
9001 to 1000	62-22175-64							

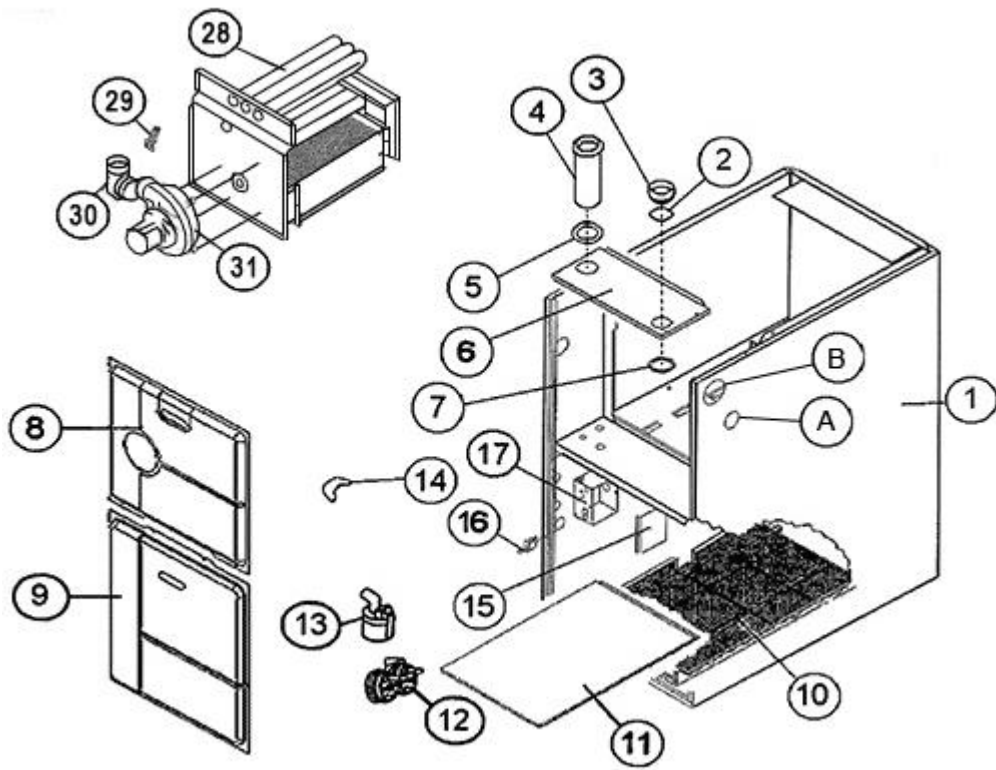

Exploded View

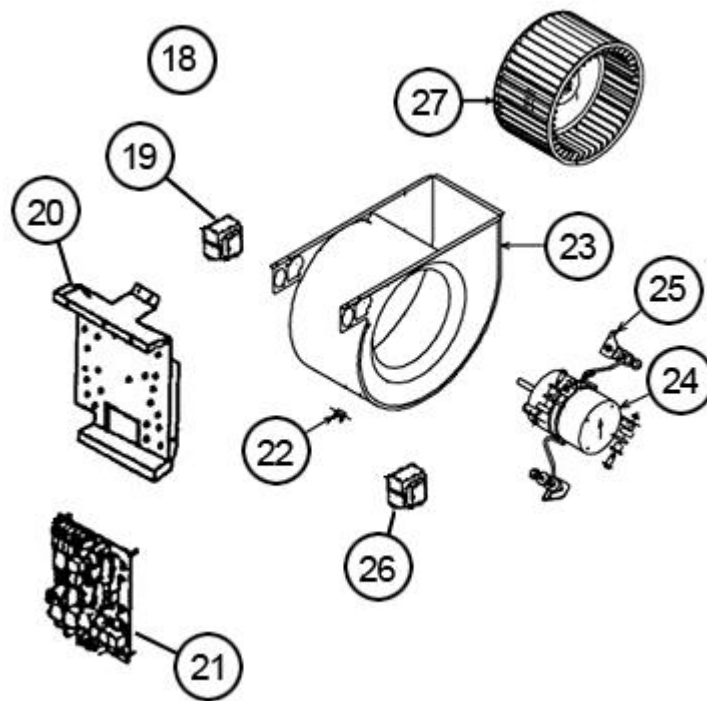

Blower Assembly

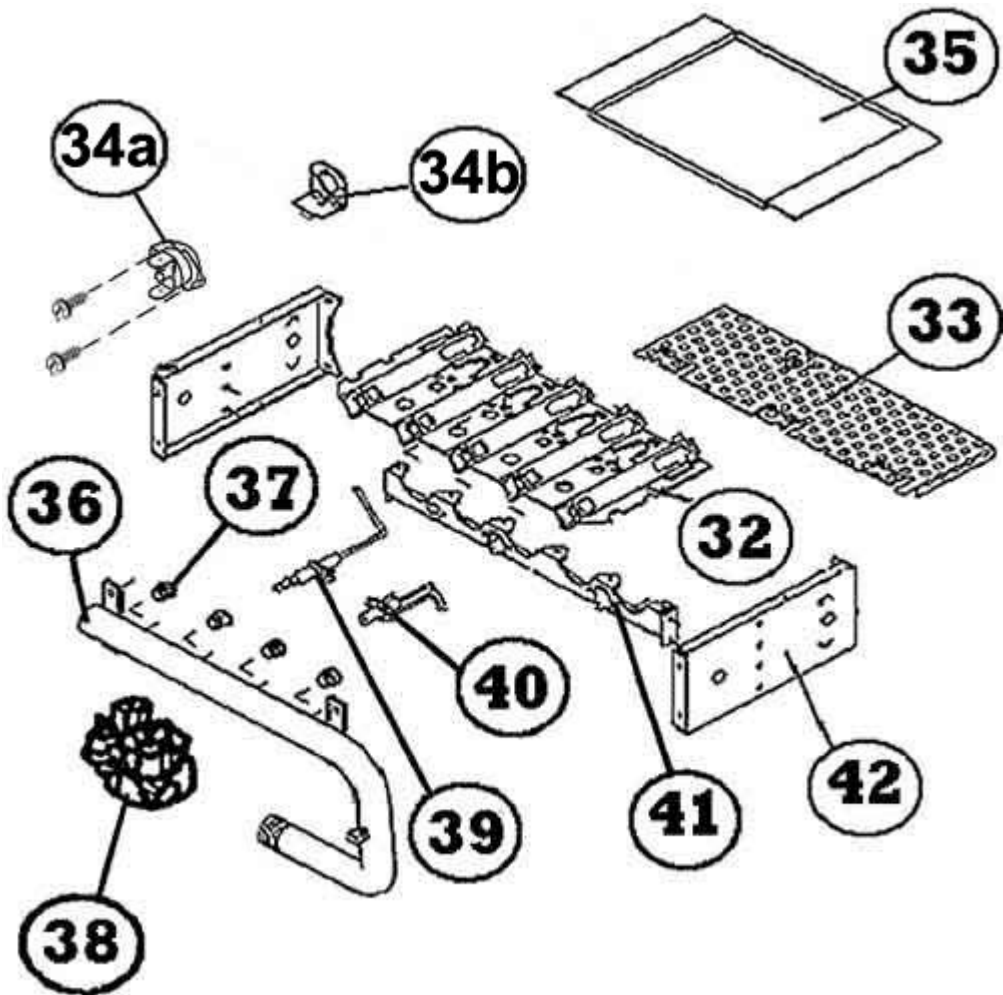

Burner Assembly

# NOTES

Stk It is recommended that stock be maintained for this part.

N/A Not Applicable

- 1 Order the specified LP Conversion Kit.
- 2 Order Gas Valve for Natural Gas along with LP Conversion Kit
- 3 The Induced Draft Blower utilized before F3010, used a remotely mounted Capacitor. Blowers after this date include a Capacitor with the Induced Draft Blower.
- 4 On or after Date Code 1112, A 11 X 10 inch blower assembly replaced the original 12 X 11 inch blower assembly. This change provides equal blower performance and reduces overall motor noise. Note: This change is not backward compatible, as motor programming was changed to provide the same CFM performance as the original 12 x 11 assembly.