

This Owner's Manual is provided and hosted by [Appliance Factory Parts](#).



COMFORT-AIRE MPHG60A-1K Owner's Manual

[Shop genuine replacement parts for COMFORT-AIRE
MPHG60A-1K](#)



[Find Your COMFORT-AIRE HVAC Parts - Select From 1486 Models](#)

----- Manual continues below -----

HEAT CONTROLLER, INC.

MPHG

Parts List
20-March-2012



This parts list is current as of the above revision date.

Form Number: 92-42810-MPHG

Table of Contents

Model Explanation	Page 3
Parts Numbers	
Panels - Miscellaneous	Page 4
Electrical Group	Page 5
Fan Group	Page 6
Blower Group	Page 6
Coil Parts	Page 7
Compressor Group	Page 7
Heater Kits	Page 8
Accessories	Page 8
Drawings/Photographs	
Exploded View	Page 9
Control Panel	Page 10
Blower Assembly	Page 11
Coil Assembly	Page 12
Compressor and Refrigeration Group	Page 13
Notes	Page 14

MODEL NUMBER EXPLANATION

M	P	H	G	2	4	A	-	1	K
1			2		3				

- (1) **SERIES**
- (2) **COOLING CAPACITY (BTU/HR)**
 24= 24,000
 30= 30,000
 36= 36,000
 42= 42,000
 48= 48,000
 60= 60,000
- (3) **VARIATION**

SERIAL NUMBER EXPLANATION

7	5	4	4	F	0	2	0	9	9	9	9	9
1				2	3		4		5			

- (1) **COMPRESSOR IDENTIFICATION NUMBER**
- (2) **PRODUCTION LOCATION**
- (3) **WEEK OF PRODUCTION**
- (4) **YEAR OF PRODUCTION**
- (5) **PRODUCTION NUMBER**

No.	Notes	MODEL COOLING CAPACITY VARIATION	MPHG 24 A-1K	MPHG 30 A-1K	MPHG 36 A-1K	MPHG 42 A-1K	MPHG 48 A-1K	MPHG 60 A-1K	
PANELS, MISCELLANEOUS PARTS									
1		Louver Panel	AS-100830-02C	AS-100830-02C	AS-100830-02C	AS-100830-04C	AS-100830-04C	AS-100830-04C	
2		Corner Post	AS-100822-01C	AS-100822-01C	AS-100822-01C	AS-100822-02C	AS-100822-02C	AS-100822-02C	
3		Front Post	AS-100821-01C	AS-100821-01C	AS-100821-01C	AS-100821-02C	AS-100821-02C	AS-100821-02C	
4		Louver Panel	AS-100830-01C	AS-100830-01C	AS-100830-01C	AS-100830-03C	AS-100830-03C	AS-100830-03C	
5		Insulation Retainer	AE-100831-02	AE-100831-02	AE-100831-02	AE-100831-03	AE-100831-03	AE-100831-03	
6		Front Access Panel	AS-100823-01C	AS-100823-01C	AS-100823-01C	AS-100821-02C	AS-100821-02C	AS-100821-02C	
7		Drainpan	See Coil Group						
8		Air Stop - Drain pan	AE-100825-01	AE-100825-01	AE-100825-01	AE-100825-01	AE-100825-01	AE-100825-01	
9		Air Stop - Drain pan	AE-100825-02	AE-100825-02	AE-100825-02	AE-100825-02	AE-100825-02	AE-100825-02	
10		Drainpan Tray	AS-100809-01C	AS-100809-01C	AS-100809-01C	AS-100809-01C	AS-100809-01C	AS-100809-01C	
11		Control Access Panel	AS-100824-01C	AS-100824-01C	AS-100824-01C	AS-100824-02C	AS-100824-02C	AS-100824-02C	
12		Control Panel Assembly	AS-100807-01	AS-100807-01	AS-100807-01	AS-100807-02	AS-100807-02	AS-100807-02	
13		Base Rail (2)	AE-102792-01	AE-102792-01	AE-102792-01	AE-102792-01	AE-102792-01	AE-102792-01	
14		Base Rail (2)	N/A	N/A	N/A	N/A	N/A	N/A	
15		Base Pan	AS-100804-01C	AS-100804-01C	AS-100804-01C	AS-100804-01C	AS-100804-01C	AS-100804-01C	
16		Right Panel Assembly	AS-100820-01C	AS-100820-01C	AS-100820-01C	AS-100820-02C	AS-100820-02C	AS-100820-02C	
17		Blower Support	AE-100818-02	AE-100818-02	AE-100818-02	AE-100818-02	AE-100818-02	AE-100818-02	
		Insulation Retainer (2)	AE-100831-01	AE-100831-01	AE-100831-01	AE-100831-01	AE-100831-01	AE-100831-01	
		Duct Ring - 14 in.	58-100850-01	58-100850-01	58-100850-01	58-100850-01	58-100850-01	58-100850-01	
18		Transition Bottom	AE-100815-01	AE-100815-01	AE-100815-01	AE-100815-01	AE-100815-01	AE-100815-01	
19		Transition Top	AE-100815-02	AE-100815-02	AE-100815-02	AE-100815-02	AE-100815-02	AE-100815-02	
20		Block Off Plate	AE-100816-01	AE-100816-01	AE-100816-01	AE-100816-01	AE-100816-01	AE-100816-01	
21		Rear Panel Assembly	AS-100814-01C	AS-100814-01C	AS-100814-01C	AS-100814-02C	AS-100814-02C	AS-100814-02C	
22		Rear Air Stop	AE-100810-01	AE-100810-01	AE-100810-01	AE-100810-02	AE-100810-02	AE-100810-02	
23		Top Panel Assembly (Indoor)	AS-100828-01C	AS-100828-01C	AS-100828-01C	AS-100828-01C	AS-100828-01C	AS-100828-01C	
24		Top Panel (Outdoor)	AS-100829-01C	AS-100829-01C	AS-100829-01C	AS-100829-01C	AS-100829-01C	AS-100829-01C	
25		Grille	95-100906-07	95-100906-07	95-100906-07	95-100906-07	95-100906-07	95-100906-07	
28		Blower Support	AE-100818-01	AE-100818-01	AE-100818-01	AE-100818-01	AE-100818-01	AE-100818-01	
29		Bulkhead Cap Assembly	AS-100826-01C	AS-100826-01C	AS-100826-01C	AS-100826-01C	AS-100826-01C	AS-100826-01C	
30		Bulkhead Assembly	AS-100812-01	AS-100812-01	AS-100812-01	AS-100812-02	AS-100812-02	AS-100812-02	
38		Low Voltage Mount	AE-100839-01	AE-100839-01	AE-100839-01	AE-100839-01	AE-100839-01	AE-100839-01	
39		Low Voltage Cover	AE-100839-02	AE-100839-02	AE-100839-02	AE-100839-02	AE-100839-02	AE-100839-02	
44		Heater Kit Delete Plate (Mounted in Control Box)	AE-100842-01	AE-100842-01	AE-100842-01	AE-100842-01	AE-100842-01	AE-100842-01	
51		Gaugeport Enclosure	AE-101352-01	AE-101352-01	AE-101352-01	AE-101352-01	AE-101352-01	AE-101352-01	

No.	Notes	MODEL COOLING CAPACITY VARIATION	MPHG 24 A-1K	MPHG 30 A-1K	MPHG 36 A-1K	MPHG 42 A-1K
ELECTRICAL GROUP						
CONTROL BOX COMPONENTS:						
40		Terminal Strip	45-23591-01	45-23591-01	45-23591-01	45-23591-01
41	Stk	Transformer	46-18788-11	46-18788-11	46-18788-11	46-18788-11
42	Stk	Blower Time Delay	47-23433-05	47-23433-05	47-23433-05	47-23433-05
43	Stk	Relay	42-101208-01	42-101208-01	42-101208-01	42-101208-01
45	Stk	Capacitor (Blower Motor)	See Blower Group			
46		Capacitor Strap (Blower Motor)	AE-50892-01	AE-50892-01	AE-50892-01	AE-50892-01
47	Stk	Contactactor	42-102851-02	42-102851-02	42-102851-02	42-102851-02
48	Stk	Capacitor - Compressor/Fan	See Compressor Group			
49		Capacitor Strap (Compressor/Fan)	AE-50892-56	AE-50892-56	AE-50892-56	AE-50892-56
50	Stk	Defrost Control Board	47-102684-03	47-102684-03	47-102684-03	47-102684-03

No.	Notes	MODEL COOLING CAPACITY VARIATION	MPHG 48 A-1K	MPHG 60 A-1K		
ELECTRICAL GROUP						
CONTROL BOX COMPONENTS:						
40		Terminal Strip	45-23591-01	45-23591-01		
41	Stk	Transformer	46-18788-11	46-18788-11		
42	Stk	Blower Time Delay	47-23433-05	47-23433-05		
43	Stk	Relay	42-101208-01	42-101208-01		
45	Stk	Capacitor - Blower Motor	See Blower Group			
46		Capacitor Strap (Blower Motor)	AE-50892-01	AE-50892-01		
47	Stk	Contactactor	42-102851-02	42-42478-02		
48	Stk	Capacitor - Compressor/Fan	See Compressor Group			
49		Capacitor Strap (Compressor/Fan)	AE-50892-56	AE-50892-56		
50	Stk	Defrost Control Board	47-102684-03	47-102684-03		

No.	Notes	MODEL COOLING CAPACITY VARIATION	MPHG 24 A-1K	MPHG 30 A-1K	MPHG 36 A-1K	MPHG 42 A-1K
FAN GROUP						
26	Stk	Fan Motor	51-100998-24	51-100998-24	51-100998-24	51-100998-25
27	Stk	Fan Blade	70-101323-20	70-101323-20	70-101323-20	70-100580-09
48		Capacitor - Fan Motor	See Compressor Group			

No.	Notes	MODEL COOLING CAPACITY VARIATION	MPHG 48 A-1K	MPHG 60 A-1K		
FAN GROUP						
26	Stk	Fan Motor	51-100998-25	51-100998-25		
27	Stk	Fan Blade	70-100580-09	70-100580-09		
48		Capacitor - Fan Motor	See Compressor Group			

No.	Notes	MODEL COOLING CAPACITY VARIATION	MPHG 24 A-1K	MPHG 30 A-1K	MPHG 36 A-1K	MPHG 42 A-1K
BLOWER GROUP						
	Stk	Blower Assembly	AS-100841-01	AS-100841-02	AS-100841-03	AS-100841-04
53		Blower Housing w/Wheel	70-100840-01	70-100840-01	70-100840-01	70-100840-02
	Stk	Blower Wheel	703017	703017	703017	703016
54		Motor Band	70-19927-03	70-19927-03	70-19927-03	70-19927-03
55		Arm Assembly	70-19929-09	70-19929-09	70-19929-09	70-19929-09
56	Stk	Blower Motor	51-100837-01	51-100837-02	51-100837-03	51-100837-04
45	Stk	Capacitor - Blower Motor	43-100496-09	43-100496-39	43-100496-41	43-100496-42

No.	Notes	MODEL COOLING CAPACITY VARIATION	MPHG 48 A-1K	MPHG 60 A-1K		
BLOWER GROUP						
	Stk	Blower Assembly	AS-100841-05	AS-100841-06		
53		Blower Housing w/Wheel	70-100840-02	70-100840-02		
	Stk	Blower Wheel	703016	703016		
54		Motor Band	70-19927-03	70-19927-03		
55		Arm Assembly	70-19929-09	70-19929-09		
56	Stk	Blower Motor	51-100837-05	51-100837-06		
45	Stk	Capacitor - Blower Motor	43-100496-42	43-100496-49		

No.	Notes	MODEL COOLING CAPACITY VARIATION	MPHG 24 A-1K	MPHG 30 A-1K	MPHG 36 A-1K	MPHG 42 A-1K	MPHG 48 A-1K	MPHG 60 A-1K
COIL GROUP								
CONDENSER COIL:								
32	Stk	Condenser Coil (Outdoor Coil)	AS-100793-14	AS-100793-15	AS-100793-15	AS-100793-16	AS-100793-16	AS-100793-17
		Distributor Assembly	83-102272-01	83-102272-01	83-102272-01	83-102272-01	83-102272-01	83-102272-02
EVAPORATOR COIL:								
33	Stk	Evaporator Coil (Indoor)	AS-100792-14	AS-100792-15	AS-100792-15	AS-100792-16	AS-100792-16	AS-100792-17
7	Stk	Drain Pan - Evaporator Coil	68-100808-02	68-100808-02	68-100808-02	68-100808-02	68-100808-02	68-100808-02
34		Distributor Assembly	83-102278-01	83-102278-02	83-102278-02	83-102278-03	83-102278-03	83-102278-04
35		Drain Trap Assembly	68-100846-02	68-100846-02	68-100846-02	68-100846-02	68-100846-02	68-100846-02
37	Stk,2	TXV - Sporlan (See Note 2)	61-102211-07	61-102211-09	61-102211-10	61-102211-11	61-102211-12	61-102211-13
37	Stk,2	TXV - Emerson (See Note 2)	61-102213-04	61-102213-05	61-102213-03	61-102213-06	61-102213-07	61-102213-08
		TXV Bulb Strap Kit	64-101357-01	64-101357-01	64-101357-01	64-101357-01	64-101357-01	64-101357-01
REFRIGERATION GROUP:								
	Stk	Charge Compensator	83-25361-01	N/A	N/A	N/A	N/A	N/A
36	Stk,1	Reversing Valve w/Coil - See Note 1	61-101684-02	61-101684-02	61-101684-02	61-101684-06	61-101684-06	61-101684-03
	Stk	Solenoid Coil - RV	61-101713-01	61-101713-01	61-101713-01	61-101713-01	61-101713-01	61-101713-01
		Wiring Harness - Reversing Valve	61-26149-01	61-26149-01	61-26149-01	61-26149-01	61-26149-01	61-26149-01
51		Gaugeport Manifold - Valve Body (2)	61-22369-04	61-22369-04	61-22369-04	61-22369-04	61-22369-04	61-22369-04
51		Gaugeport Manifold - Valve Core (2)	61-18551-01	61-18551-01	61-18551-01	61-18551-01	61-18551-01	61-18551-01
	Stk	Filter Drier	83-41714-03	83-41714-03	83-41714-03	83-41714-01	83-41714-01	83-41714-01
		Filter Drier Strap	AE-102132-01	AE-102132-01	AE-102132-01	AE-102132-01	AE-102132-01	AE-102132-01

No.	Notes	MODEL COOLING CAPACITY VARIATION	MPHG 24 A-1K	MPHG 30 A-1K	MPHG 36 A-1K	MPHG 42 A-1K	MPHG 48 A-1K	MPHG 60 A-1K
COMPRESSOR GROUP								
		Compressor ID:	7544	7545	7546	7547	7549	7551
31	Stk	Compressor	55-102045-24S	55-102045-02S	55-102045-03S	55-102045-12S	55-102045-09S	55-102045-26S
48	Stk	Capacitor - Fan/Compressor	43-101665-44	43-101665-09	43-26271-41	43-26271-48	43-26271-47	43-26271-47
57	Stk	Compressor Wiring Harness (Plug)	45-100834-80	45-100834-80	45-100834-80	45-100834-80	45-100834-80	45-100834-80
		Compressor ID:				7548		7552
31	Stk	Compressor				55-102282-05S		55-102282-01S
48	Stk	Run Capacitor - Fan/Compressor				43-101665-38		43-26271-47
57	Stk	Compressor Wiring Harness (Plug)				45-102303-01		45-102303-01

No.	Notes	MODEL COOLING CAPACITY VARIATION	MPHG 24 A-1K	MPHG 30 A-1K	MPHG 36 A-1K	MPHG 42 A-1K	MPHG 48 A-1K	MPHG 60 A-1K
HEATER KITS								
		Heater Kit (5 kW)	RXQJ-C05J	RXQJ-C05J	RXQJ-C05J	RXQJ-C05J	RXQJ-C05J	RXQJ-C05J
		Heater Kit (7 kW)	RXQJ-C07J	RXQJ-C07J	RXQJ-C07J	RXQJ-C07J	RXQJ-C07J	RXQJ-C07J
		Heater Kit (10 kW)	RXQJ-C10J	RXQJ-C10J	RXQJ-C10J	RXQJ-C10J	RXQJ-C10J	RXQJ-C10J
		Heater Kit (15 kW)		RXQJ-C15J	RXQJ-C15J			
		Heater Kit (20 kW)				RXQJ-C20J	RXQJ-C20J	RXQJ-C20J

No.	Notes	MODEL COOLING CAPACITY VARIATION	MPHG ALL ALL					
ACCESSORIES								
		Outdoor Thermostat	RXPT-A01					

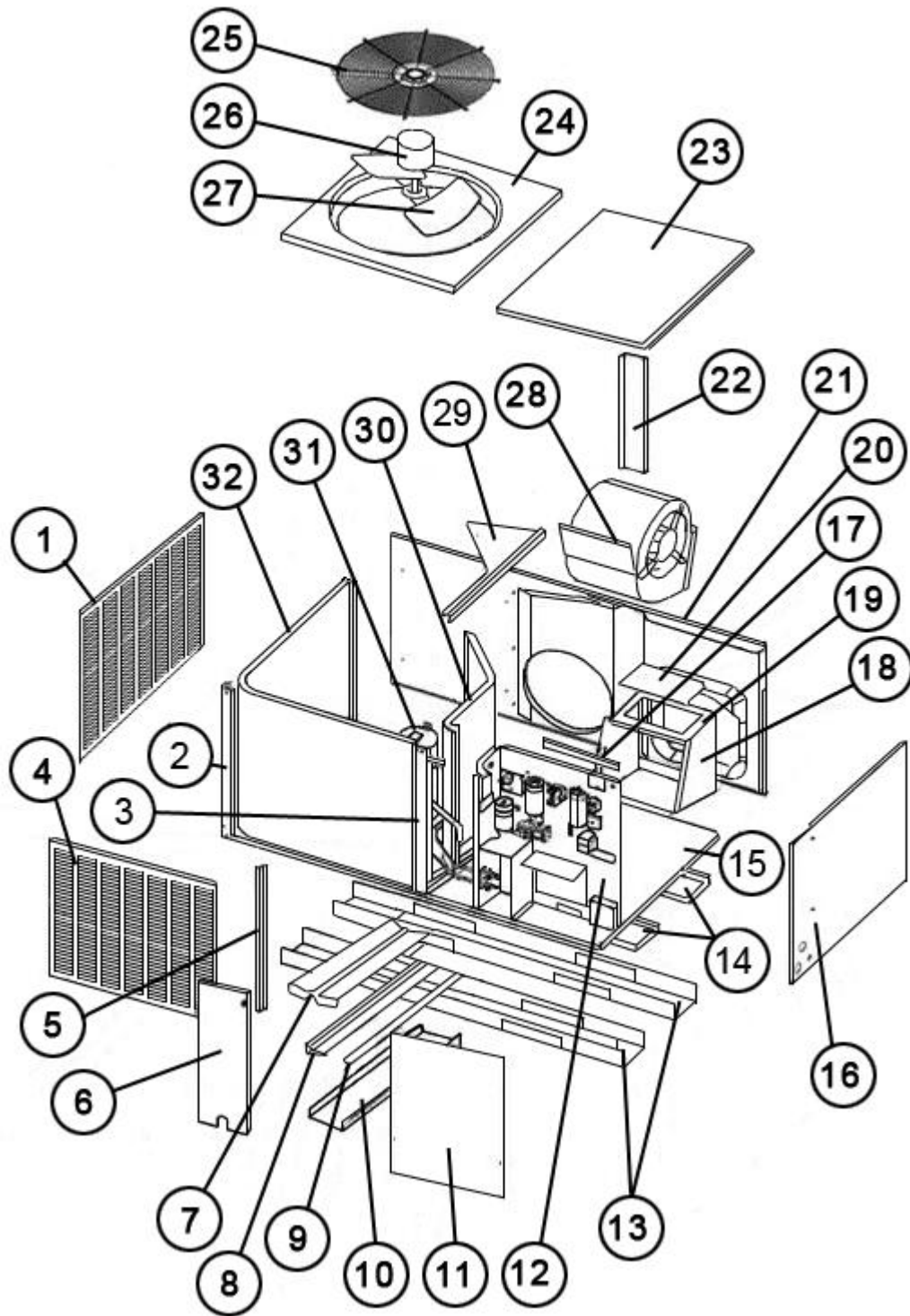

Exploded View

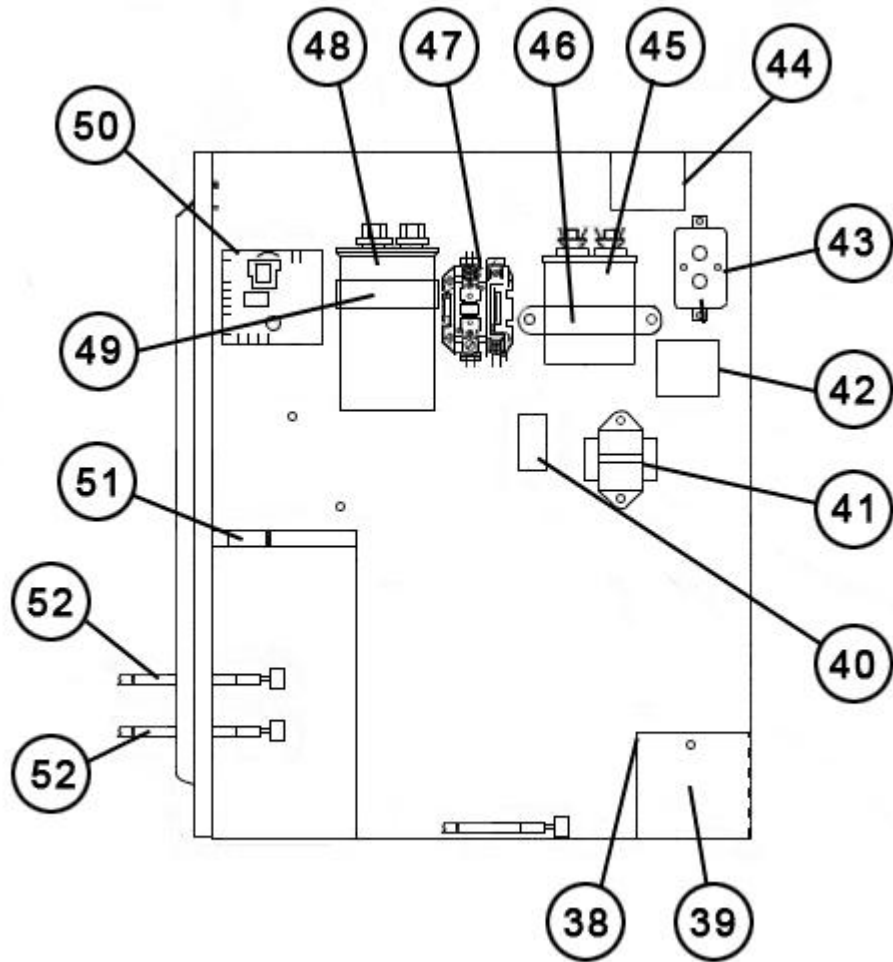

Control Panel

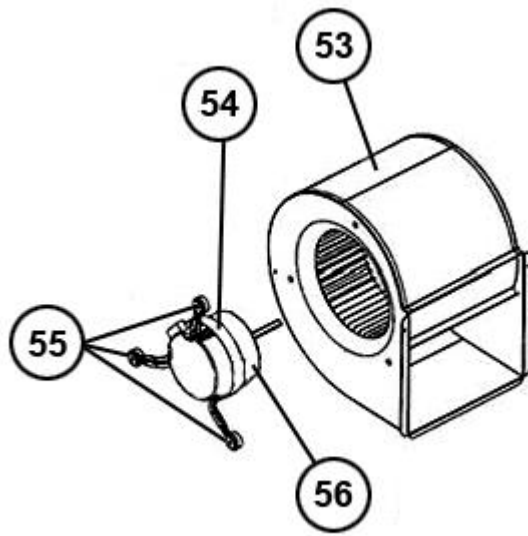

Blower Assembly

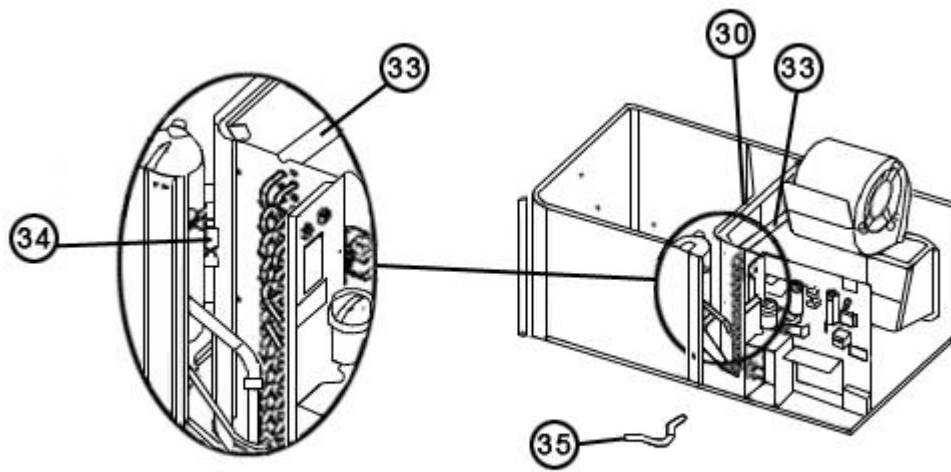

Coil Assembly

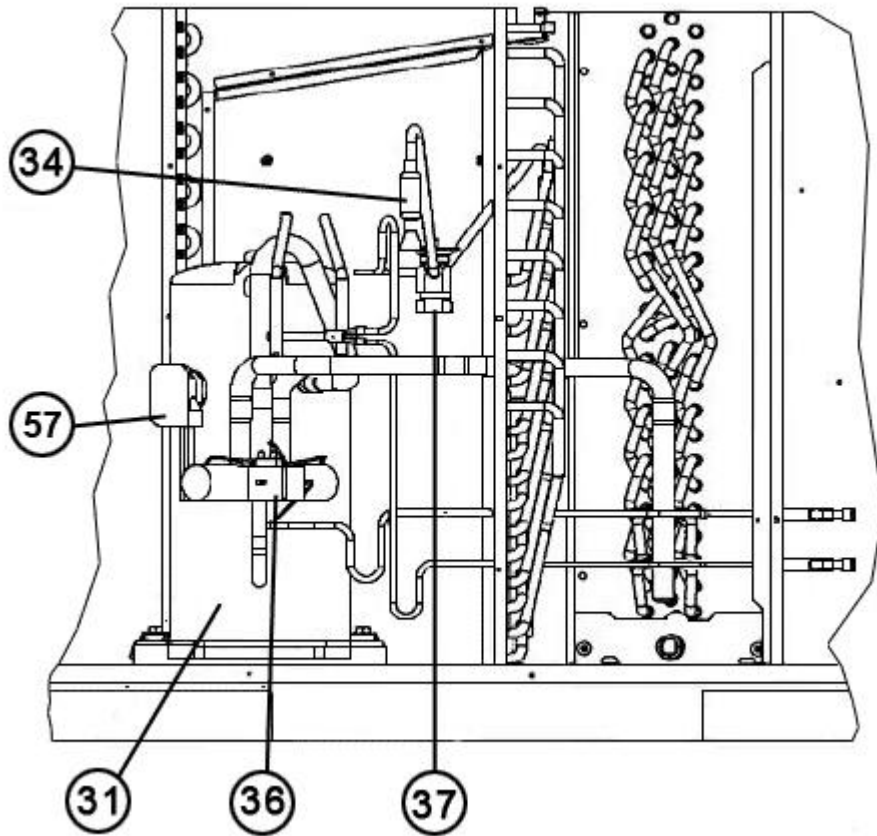

Compressor and Refrigeration Group

NOTES

Stk It is recommended that stock be maintained for this part.

N/A Not Applicable

- 1 The reversing valve specified for 042, 048 models may be different than the one originally supplied with the equipment. The use of the specified valve is recommended for improved shifting performance.
- 2 The Sporlan and Emerson valves specified for this unit may be interchanged in service. The valves are interchangeable for this specific model only.