

This Owner's Manual is provided and hosted by [Appliance Factory Parts](http://www.appliancefactoryparts.com).



# COMFORT-AIRE HFE4221EP-1A Owner's Manual

[Shop genuine replacement parts for COMFORT-AIRE  
HFE4221EP-1A](#)



[Find Your COMFORT-AIRE HVAC Parts - Select From 1486 Models](#)

----- Manual continues below -----

# HFE-EP

HEAT CONTROLLER, INC.

Parts List  
28-March-2012



*This parts list is current as of the above revision date.*

Form Number: 92-42810-HFE-EP

# Table of Contents

Model Explanation .....	Page 3
Parts Numbers	
Panels - Miscellaneous .....	Page 4
Electrical Group .....	Page 5
Blower Group .....	Page 7
Coil Parts .....	Page 8
Heater Kits .....	Page 8
Drawings/Photographs	
Exploded View .....	Page 9
Blower Assembly .....	Page 10
Notes .....	Page 11

**MODEL NUMBER EXPLANATION**

<b>H</b>	<b>F</b>	<b>E</b>	<b>24</b>	<b>17</b>	<b>EP</b>	<b>-</b>	<b>1</b>	<b>A</b>
	1		2	3	4		5	6

- |  |  |
|--|--|
| <p><b>1 HEAT CONTROLLER SERIES</b><br/>A/C OR HP, MULTI-POSITION<br/>(PSC MOTOR)</p> <p><b>2 CAPACITY</b><br/>18= 18,000 BTU/HR<br/>24= 24,000 BTU/HR<br/>30= 30,000 BTU/HR<br/>36= 36000 BTU/HR<br/>42= 42,000 BTU/HR<br/>48= 48,000 BTU/HR</p> | <p><b>3 CABINET SIZE</b><br/>17= 17.5 in.<br/>21= 21 in.<br/>24= 24.5 in.</p> <p><b>4 REFRIGERANT</b><br/>EP= R22<br/>GP= R410A</p> <p><b>5 VOLTAGE</b><br/>0= 115/1/60<br/>1= 208-240/1/60</p> <p><b>6 DESIGN VARIATION - A</b></p> |
|--|--|

**SERIAL NUMBER EXPLANATION**

<b>M</b>	<b>0</b>	<b>7</b>	<b>0</b>	<b>1</b>	<b>9</b>	<b>9</b>	<b>9</b>	<b>9</b>	<b>9</b>
1	2		3		4				

- |          |                            |
|----------|----------------------------|
| <b>1</b> | <b>PRODUCTION LOCATION</b> |
| <b>2</b> | <b>WEEK OF PRODUCTION</b>  |
| <b>3</b> | <b>YEAR OF PRODUCTION</b>  |
| <b>4</b> | <b>PRODUCTION NUMBER</b>   |

No.	Notes	MODEL	HFE	HFE	HFE	HFE	HFE	HFE
		CAPACITY	18	18	24	24	30	30
		CABINET SIZE	17	17	17	17	17	17
		CONFIGURATION	EP	EP	EP	EP	EP	EP
		VOLTAGE	0	1	0	1	0	1
		VARIATION	A	A	A	A	A	A
<b>PANELS, SHEET METAL, MISCELLANEOUS</b>								
1		Cabinet	AE-100682-01	AE-100682-01	AE-100682-01	AE-100682-01	AE-100682-01	AE-100682-01
2		Coil Door	AE-100685-22	AE-100685-22	AE-100685-22	AE-100685-22	AE-100685-22	AE-100685-22
3		Top Cover Plate	AE-100686-01	AE-100686-01	AE-100686-01	AE-100686-01	AE-100686-01	AE-100686-01
4		Blower Door	AE-100684-21	AE-100684-21	AE-100684-21	AE-100684-21	AE-100684-21	AE-100684-21
5		Access Panel	AE-101133-21	AE-101133-21	AE-101133-21	AE-101133-21	AE-101133-21	AE-101133-21
6		Drain Pan - Vertical	See RCSA Coil Parts List					
7		Drain Pan - Horizontal	See RCSA Coil Parts List					
8		Plate - Block Off	AE-100455-01	AE-100455-01	AE-100455-01	AE-100455-01	AE-100455-01	AE-100455-01
9		Cabinet Brace	AE-101134-02	AE-101134-02	AE-101134-02	AE-101134-02	AE-101134-02	AE-101134-02
10		Middle Brace	AE-101054-01	AE-101054-01	AE-101054-01	AE-101054-01	AE-101054-01	AE-101054-01
13a		Heat Barrier	AE-100683-02	AE-100683-02	AE-100683-02	AE-100683-02	AE-100683-03	AE-100683-03
13b		Heat Barrier Side (2)	AE-104241-01	AE-104241-01	AE-104241-01	AE-104241-01	AE-104241-01	AE-104241-01
		Insulation Retainer Rod (2)	45-102868-02	45-102868-02	45-102868-02	45-102868-02	45-102868-02	45-102868-02

No.	Notes	MODEL	HFE	HFE	HFE	HFE	HFE	HFE
		CAPACITY	36	36	42	42	48	48
		CABINET SIZE	17	17	21	21	21	21
		CONFIGURATION	EP	EP	EP	EP	EP	EP
		VOLTAGE	0	1	0	1	0	1
		VARIATION	A	A	A	A	A	A
<b>PANELS, SHEET METAL, MISCELLANEOUS</b>								
1		Cabinet	AE-100682-01	AE-100682-01	AE-100682-03	AE-100682-03	AE-100682-03	AE-100682-03
2		Coil Door	AE-100685-22	AE-100685-22	AE-100685-24	AE-100685-24	AE-100685-24	AE-100685-24
3		Top Cover Plate	AE-100686-01	AE-100686-01	AE-100686-02	AE-100686-02	AE-100686-02	AE-100686-02
4		Blower Door	AE-100684-21	AE-100684-21	AE-100684-22	AE-100684-22	AE-100684-22	AE-100684-22
5		Access Panel	AE-101133-21	AE-101133-21	AE-101133-21	AE-101133-21	AE-101133-21	AE-101133-21
6		Drain Pan - Vertical	See RCSA Coil Parts List					
7		Drain Pan - Horizontal	See RCSA Coil Parts List					
8		Plate - Block Off	AE-100455-01	AE-100455-01	AE-100455-01	AE-100455-01	AE-100455-01	AE-100455-01
9		Cabinet Brace	AE-101134-02	AE-101134-02	AE-101134-03	AE-101134-03	AE-101134-03	AE-101134-03
10		Middle Brace	AE-101054-01	AE-101054-01	AE-101054-02	AE-101054-02	AE-101054-02	AE-101054-02
13a		Heat Barrier	AE-100683-03	AE-100683-03	AE-100683-06	AE-100683-06	AE-100683-06	AE-100683-06
13b		Heat Barrier Side (2)	AE-104241-01	AE-104241-01	AE-104241-01	AE-104241-01	AE-104241-01	AE-104241-01
		Insulation Retainer Rod (2)	45-102868-02	45-102868-02	45-102868-03	45-102868-03	45-102868-03	45-102868-03

No.	Notes	MODEL	HFE	HFE	HFE	HFE	HFE	HFE
		CAPACITY	18	18	24	24	30	30
		CABINET SIZE	17	17	17	17	17	17
		CONFIGURATION	EP	EP	EP	EP	EP	EP
		VOLTAGE	0	1	0	1	0	1
		VARIATION	A	A	A	A	A	A
ELECTRICAL GROUP								
17	Stk	Transformer	46-101944-02	46-101944-02	46-101944-02	46-101944-02	46-101944-02	46-101944-02
18	Stk	Control Board - Before M3807	47-100436-84A	47-100436-84J	47-100436-84A	47-100436-84J	47-100436-84A	47-100436-84J
18	Stk	Control Board - After M3807	47-100436-05	47-100436-05	47-100436-05	47-100436-05	47-100436-05	47-100436-05
	Stk	Fuse	44-101986-01	44-101986-01	44-101986-01	44-101986-01	44-101986-01	44-101986-01
		Relay	N/A	N/A	N/A	N/A	N/A	N/A
		Wiring Harness - Before M3807 4 Pin Molex to 2 stripped wires, 2 terminals	N/A	45-24371-43	N/A	45-24371-43	N/A	45-24371-43
		Wiring Harness - Before M3807 5 Pin Molex to 5 stripped wires (For T-Stat)	45-102645-01	N/A	45-102645-01	N/A	45-102645-01	N/A
		Wiring Harness - After M3807 5 Pin Molex to 3 stripped wires (For T-Stat)	45-102645-02	N/A	45-102645-02	N/A	45-102645-02	N/A
		Wiring Harness - After M3807 5 Pin Molex to 5 stripped wires	N/A	45-102645-01	N/A	45-102645-01	N/A	45-102645-01
		Wiring Harness - 1 strip lead and 1 connector to single connector (Control Transformer to Terminal Block)	45-24258-17	45-24258-17	45-24258-17	45-24258-17	45-24258-17	45-24258-17
		Wiring Harness - 1 strip lead and 1 connector to single connector (Control Transformer to Blower Motor and Terminal Block)	45-24258-23	45-24258-21	45-24258-23	45-24258-21	45-24258-23	45-24258-21
11		Terminal Block	45-23222-02	45-23222-02	45-23222-02	45-23222-02	45-23222-02	45-23222-02

No.	Notes	MODEL	HFE	HFE	HFE	HFE	HFE	HFE
		CAPACITY	36	36	42	42	48	48
		CABINET SIZE	17	17	21	21	21	21
		CONFIGURATION	EP	EP	EP	EP	EP	EP
		VOLTAGE	0	1	0	1	0	1
		VARIATION	A	A	A	A	A	A
ELECTRICAL GROUP								
17	Stk	Transformer	46-101944-02	46-101944-02	46-101944-02	46-101944-02	46-101944-02	46-101944-02
18	Stk	Control Board - Before M3807	47-100436-84A	47-100436-84J	47-100436-84A	47-100436-84J	47-100436-84A	47-100436-84J
18	Stk	Control Board - After M3807	47-100436-05	47-100436-05	47-100436-05	47-100436-05	47-100436-05	47-100436-05
	Stk	Fuse	44-101986-01	44-101986-01	44-101986-01	44-101986-01	44-101986-01	44-101986-01
		Relay	N/A	N/A	N/A	N/A	N/A	N/A
		Wiring Harness - Before M3807 4 Pin Molex to 2 stripped wires, 2 terminals	N/A	45-24371-43	N/A	45-24371-43	N/A	45-24371-43
		Wiring Harness - Before M3807 5 Pin Molex to 5 stripped wires (For T-Stat)	45-102645-01	N/A	45-102645-01	N/A	45-102645-01	N/A
		Wiring Harness - After M3807 5 Pin Molex to 3 stripped wires (For T-Stat)	45-102645-02	N/A	45-102645-02	N/A	45-102645-02	N/A
		Wiring Harness - After M3807 5 Pin Molex to 5 stripped wires	N/A	45-102645-01	N/A	45-102645-01	N/A	45-102645-01
		Wiring Harness - 1 strip lead and 1 connector to single connector (Control Transformer to Terminal Block)	45-24258-17	45-24258-17	45-24258-17	45-24258-17	45-24258-17	45-24258-17
		Wiring Harness - 1 strip lead and 1 connector to single connector (Control Transformer to Blower Motor and Terminal Block)	45-24258-23	45-24258-21	45-24258-23	45-24258-21	45-24258-23	45-24258-21
11		Terminal Block	45-23222-02	45-23222-02	45-23222-02	45-23222-02	45-23222-02	45-23222-02

No.	Notes	MODEL	HFE					
		CAPACITY	48					
		CABINET SIZE	24					
		CONFIGURATION	EP					
		VOLTAGE	1					
		VARIATION	A					
ELECTRICAL GROUP								
17	Stk	Transformer	46-101944-02					
18	Stk	Control Board - Before M3807	47-100436-84J					
18	Stk	Control Board - After M3807	47-100436-05					
	Stk	Fuse	44-101986-01					
		Relay	N/A					
		Wiring Harness - Before M3807 4 Pin Molex to 2 stripped wires, 2 terminals	45-24371-43					
		Wiring Harness - Before M3807 5 Pin Molex to 5 stripped wires (For T-Stat)	N/A					
		Wiring Harness - After M3807 5 Pin Molex to 3 stripped wires (For T-Stat)	N/A					

28-March-2012  
92-42810-HFE-EP

	Wiring Harness - After M3807 5 Pin Molex to 5 stripped wires	45-102645-01					
	Wiring Harness - 1 strip lead and 1 connector to single connector (Control Transformer to Terminal Block)	45-24258-17					
	Wiring Harness - 1 strip lead and 1 connector to single connector (Control Transformer to Blower Motor and Terminal Block)	45-24258-21					
11	Terminal Block	45-23222-02					

No.	Notes	MODEL	HFE	HFE	HFE	HFE	HFE	HFE
		CAPACITY	18	18	24	24	30	30
		CABINET SIZE	17	17	17	17	17	17
		CONFIGURATION	EP	EP	EP	EP	EP	EP
		VOLTAGE	0	1	0	1	0	1
		VARIATION	A	A	A	A	A	A
<b>BLOWER GROUP</b>								
15	Stk	Blower Assembly (Includes items 16-22) -Before M3807	AS-101929-81	AS-101931-81	AS-101929-82	AS-101931-82	AS-101929-83	AS-101931-83
15	Stk	Blower Assembly (Includes items 16-22) -After M3807	AS-101929-01	AS-101931-01	AS-101929-02	AS-101931-02	AS-101929-03	AS-101931-03
16		Mounting Bracket - Control Board	AE-101049-01	AE-101049-01	AE-101049-01	AE-101049-01	AE-101049-01	AE-101049-01
17		Transformer	See Electrical Group					
18		Control Board	See Electrical Group					
19		Blower Housing w/Wheel	70-101729-01	70-101729-01	70-101729-01	70-101729-01	70-101729-02	70-101729-02
	Stk	Blower Wheel	703012	703012	703012	703012	703014	703014
20		Motor Mount - Band	70-19927-04	70-19927-04	70-19927-04	70-19927-04	70-19927-04	70-19927-04
21		Motor Mount - Arm (4)	70-19929-10	70-19929-10	70-19929-10	70-19929-10	70-19929-10	70-19929-10
22	Stk	Blower Motor (PSC)	51-102175-01	51-101728-01	51-102175-02	51-102500-07	51-102175-03	51-101728-03
	Stk	Capacitor - Blower Motor	43-101666-55	43-101666-55	43-100510-58	43-101666-55	43-100510-56	43-100510-56
		Capacitor Strap	AE-50892-12	AE-50892-12	AE-50892-12	AE-50892-12	AE-50892-12	AE-50892-12

No.	Notes	MODEL	HFE	HFE	HFE	HFE	HFE	HFE
		CAPACITY	36	36	42	42	48	48
		CABINET SIZE	17	17	21	21	21	21
		CONFIGURATION	EP	EP	EP	EP	EP	EP
		VOLTAGE	0	1	0	1	0	1
		VARIATION	A	A	A	A	A	A
<b>BLOWER GROUP</b>								
15	Stk	Blower Assembly (Includes items 16-22) -Before M3807	AS-101929-84	AS-101931-84	AS-101929-85	AS-101931-85	AS-101929-86	AS-101931-86
15	Stk	Blower Assembly (Includes items 16-22) -After M3807	AS-101929-04	AS-101931-04	AS-101929-05	AS-101931-05	AS-101929-06	AS-101931-06
16		Mounting Bracket - Control Board	AE-101049-01	AE-101049-01	AE-101049-01	AE-101049-01	AE-101049-01	AE-101049-01
17		Transformer	See Electrical Group					
18		Control Board	See Electrical Group					
19		Blower Housing w/Wheel	70-101729-02	70-101729-02	70-101729-03	70-101729-03	70-101729-03	70-101729-03
	Stk	Blower Wheel	703014	703014	703013	703013	703013	703013
20		Motor Mount - Band	70-19927-04	70-19927-04	70-19927-04	70-19927-04	70-19927-04	70-19927-04
21		Motor Mount - Arm (4)	70-19929-10	70-19929-10	70-19929-10	70-19929-10	70-19929-10	70-19929-10
22	Stk	Blower Motor (PSC)	51-102175-04	51-101728-04	51-102175-05	51-101728-05	51-102175-06	51-101728-06
	Stk	Capacitor - Blower Motor	43-100509-43	43-100509-43	43-101666-57	43-101666-57	43-101666-57	43-101666-57
		Capacitor Strap	AE-50892-12	AE-50892-12	AE-50892-12	AE-50892-12	AE-50892-12	AE-50892-12

No.	Notes	MODEL	HFE					
		CAPACITY	48					
		CABINET SIZE	24					
		CONFIGURATION	EP					
		VOLTAGE	1					
		VARIATION	A					
<b>BLOWER GROUP</b>								
15	Stk	Blower Assembly (Includes items 16-22) Before M3807	AS-101931-86					
15	Stk	Blower Assembly (Includes items 16-22) After M3807	AS-101931-06					
16		Mounting Bracket - Control Board	AE-101049-01					
17		Transformer	See Electrical Group					
18		Control Board	See Electrical Group					
19		Blower Housing w/Wheel	70-101729-03					
	Stk	Blower Wheel	703013					
20		Motor Mount - Band	70-19927-04					
21		Motor Mount - Arm (4)	70-19929-10					
22	Stk	Blower Motor (PSC)	51-101728-06					
	Stk	Capacitor - Blower Motor	43-101666-57					
		Capacitor Strap	AE-50892-12					

No.	Notes	MODEL CAPACITY CABINET SIZE VOLTAGE	HFE 18/24 17 0/1	HFE 30/36 17 0/1	HFE 36 21 1	HFE 42/48 21 0/1	HFE 48 24 1	
<b>COIL GROUP</b>								
12		Replacement Coil w/TXV (A/C or HP, Multi-Position)	RCSA-HM2417AU	RCSA-HM3617AU	RCSA-HM3621AU	RCSA-HM4821AU	RCSA-HM4824AU	
		Drain Pan	See specified RCSA Coil Parts List					
		TXV	See specified RCSA Coil Parts List					

No.	Notes	MODEL CAPACITY CABINET SIZE VOLTAGE	HFE 18/24 17 0/1	HFE 30/36 17 0/1	HFE 36 21 1	HFE 42/48 21/24 0/1	
<b>HEATER KITS</b>							
		Heater Kit - 3kW/208-240/1	RXBH-17A03J RXBH-1724A03J RXBH-1724B03J RXBH-1724C03J	RXBH-17A03J RXBH-1724A03J RXBH-1724B03J RXBH-1724C03J	N/A	N/A	
		Heater Kit - 5kW/208-240/1	RXBH-17A05J RXBH-1724A05J RXBH-1724B05J RXBH-1724C05J	RXBH-17A05J RXBH-1724A05J RXBH-1724B05J RXBH-1724C05J	RXBH-24A05J RXBH-1724A05J RXBH-1724B05J RXBH-1724C05J	RXBH-24A05J RXBH-1724A05J RXBH-1724B05J RXBH-1724C05J	
		Heater Kit - 7kW/208-240/1	RXBH-17A07J RXBH-1724A07J RXBH-1724B07J RXBH-1724C07J	RXBH-17A07J RXBH-1724A07J RXBH-1724B07J RXBH-1724C07J	RXBH-24A07J RXBH-1724A07J RXBH-1724B07J RXBH-1724C07J	RXBH-24A07J RXBH-1724A07J RXBH-1724B07J RXBH-1724C07J	
		Heater Kit - 10kW/208-240/1	RXBH-17A10J RXBH-1724A10J RXBH-1724B10J RXBH-1724C10J	RXBH-17A10J RXBH-1724A10J RXBH-1724B10J RXBH-1724C10J	RXBH-24A10J RXBH-1724A10J RXBH-1724B10J RXBH-1724C10J	RXBH-24A10J RXBH-1724A10J RXBH-1724B10J RXBH-1724C10J	
		Heater Kit - 13kW/208-240/1	RXBH-17A13J RXBH-1724A13J	RXBH-17A13J RXBH-1724A13J	N/A	N/A	
		Heater Kit - 15kW/208-240/1	N/A	RXBH-17A15J RXBH-1724A15J	RXBH-24A15J RXBH-1724A15J	RXBH-24A15J RXBH-1724A15J	
		Heater Kit - 18kW/208-240/1	N/A	RXBH-17A18J RXBH-1724A18J	RXBH-24A18J RXBH-1724A18J	RXBH-24A18J RXBH-1724A18J	
		Heater Kit - 20kW/208-240/1	N/A	N/A	N/A	RXBH-24A20J	
		Heater Kit - 25kW/208-240/1	N/A	N/A	N/A	RXBH-24A25J	
		Heater Kit - 30kW/208-240/1	N/A	N/A	N/A	N/A	
		Heater Kit - 7kW/208-240/3	RXBH-17A07C RXBH-1724A07C	RXBH-17A07C RXBH-1724A07C	RXBH-24A07C RXBH-1724A07C	RXBH-24A07C RXBH-1724A07C	
		Heater Kit - 10kW/208-240/3	RXBH-17A10C RXBH-1724A10C	RXBH-17A10C RXBH-1724A10C	RXBH-24A10C RXBH-1724A10C	RXBH-24A10C RXBH-1724A10C	
		Heater Kit - 13kW/208-240/3	RXBH-17A13C RXBH-1724A13C	RXBH-17A13C RXBH-1724A13C	N/A	N/A	
		Heater Kit - 15kW/208-240/3	N/A	RXBH-17A15C RXBH-1724A15C	RXBH-24A15C RXBH-1724A15C	RXBH-24A15C RXBH-1724A15C	
		Heater Kit - 18kW/208-240/3	N/A	RXBH-17A18C RXBH-1724A18C	RXBH-24A18C RXBH-1724A18C	RXBH-24A18C RXBH-1724A18C	
		Heater Kit - 20kW/208-240/3	N/A	N/A	N/A	RXBH-24A20C	
		Heater Kit - 25kW/208-240/3	N/A	N/A	N/A	RXBH-24A25C	

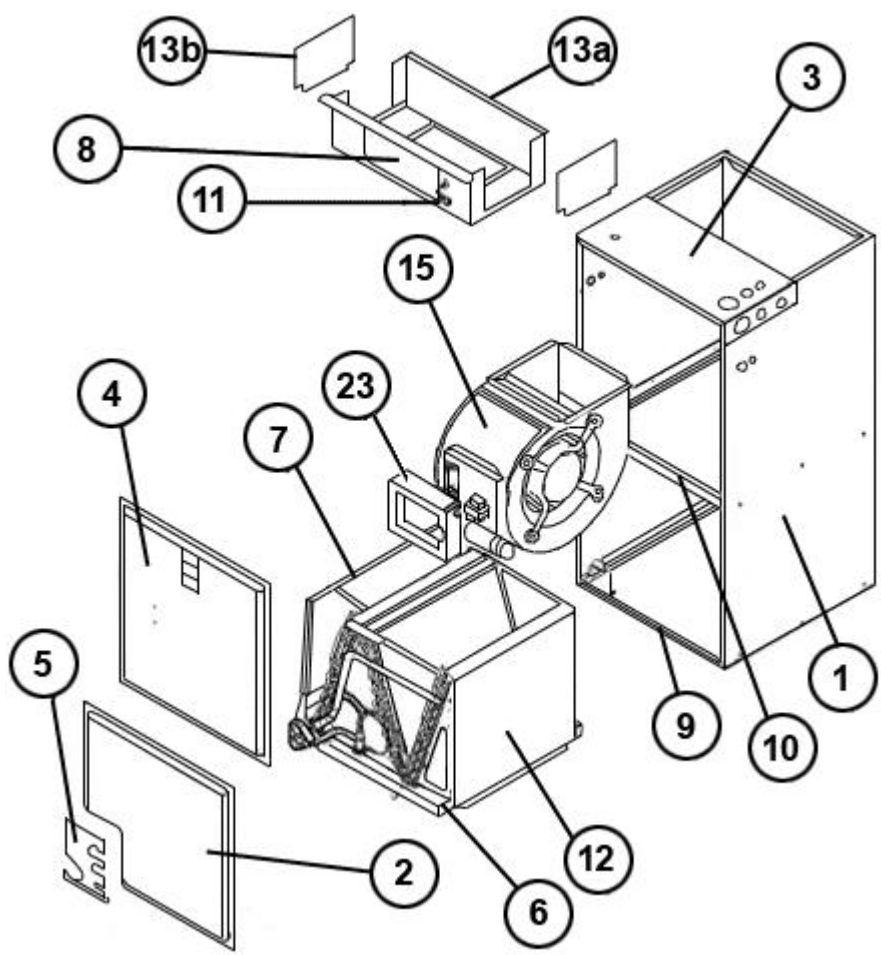

Exploded View

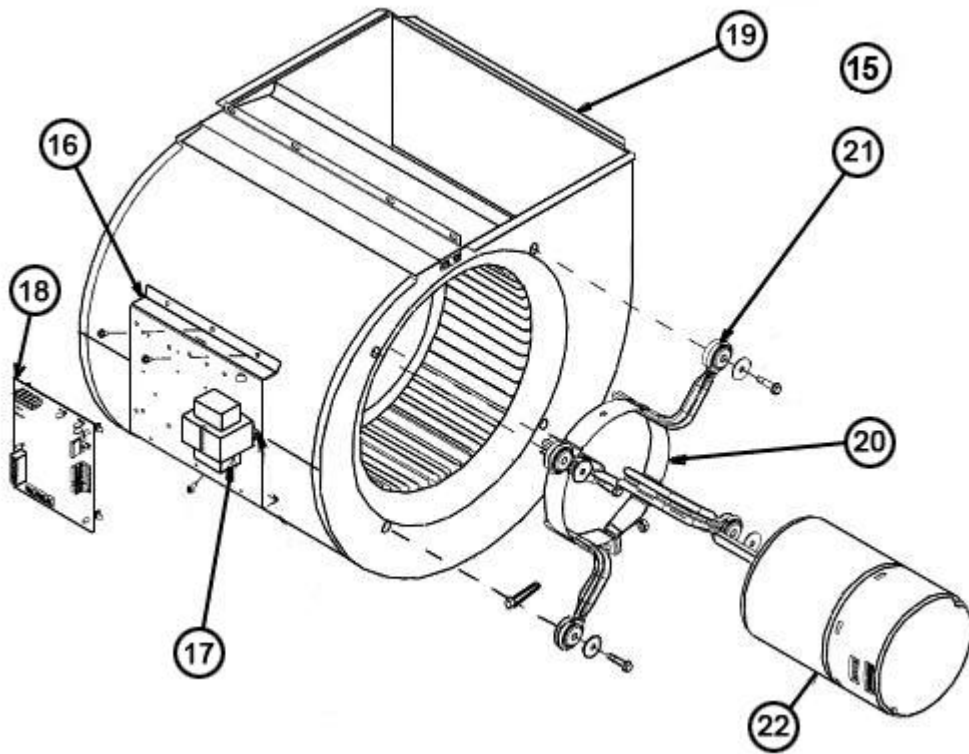

Blower Assembly

# NOTES

Stk It is recommended that stock be maintained for this part.  
N/A Not Applicable