

This Owner's Manual is provided and hosted by [Appliance Factory Parts](http://www.appliancefactoryparts.com).



COMFORT-AIRE HFE3617GP-0A Owner's Manual

[Shop genuine replacement parts for COMFORT-AIRE
HFE3617GP-0A](#)



[Find Your COMFORT-AIRE HVAC Parts - Select From 1486 Models](#)

----- Manual continues below -----

HFE-GP

HEAT CONTROLLER, INC.

Parts List
28-March-2012



This parts list is current as of the above revision date.

Form Number: 92-42810-HFE-GP

Table of Contents

Model Explanation	Page 3
Parts Numbers	
Panels - Miscellaneous	Page 4
Electrical Group	Page 5
Blower Group	Page 6
Coil Parts	Page 7
Heater Kits	Page 7
Drawings/Photographs	
Exploded View	Page 8
Blower Assembly	Page 9
Notes	Page 10

MODEL NUMBER EXPLANATION

H	F	E	24	17	EP	-	1	A
	1		2	3	4		5	6

- | | |
|--|--|
| <p>1 HEAT CONTROLLER SERIES
A/C OR HP, MULTI-POSITION
(PSC MOTOR)</p> <p>2 CAPACITY
18= 18,000 BTU/HR
24= 24,000 BTU/HR
30= 30,000 BTU/HR
36= 36000 BTU/HR
42= 42,000 BTU/HR
48= 48,000 BTU/HR</p> | <p>3 CABINET SIZE
17= 17.5 in.
21= 21 in.
24= 24.5 in.</p> <p>4 REFRIGERANT
EP= R22
GP= R410A</p> <p>5 VOLTAGE
0= 115/1/60
1= 208-240/1/60</p> <p>6 DESIGN VARIATION - A</p> |
|--|--|

SERIAL NUMBER EXPLANATION

M	0	7	0	1	9	9	9	9	9
1		2		3					4

- | | |
|---|----------------------------|
| 1 | PRODUCTION LOCATION |
| 2 | WEEK OF PRODUCTION |
| 3 | YEAR OF PRODUCTION |
| 4 | PRODUCTION NUMBER |

No.	Notes	MODEL	HFE	HFE	HFE	HFE	HFE	HFE
		CAPACITY	18	18	24	24	30	30
		CABINET SIZE	17	17	17	17	17	17
		CONFIGURATION	GP	GP	GP	GP	GP	GP
		VOLTAGE	0	1	0	1	0	1
		VARIATION	A	A	A	A	A	A
PANELS, SHEET METAL, MISCELLANEOUS								
1		Cabinet	AE-100682-01	AE-100682-01	AE-100682-01	AE-100682-01	AE-100682-01	AE-100682-01
2		Coil Door	AE-100685-22	AE-100685-22	AE-100685-22	AE-100685-22	AE-100685-22	AE-100685-22
3		Top Cover Plate	AE-100686-01	AE-100686-01	AE-100686-01	AE-100686-01	AE-100686-01	AE-100686-01
4		Blower Door	AE-100684-21	AE-100684-21	AE-100684-21	AE-100684-21	AE-100684-21	AE-100684-21
5		Access Panel	AE-101133-21	AE-101133-21	AE-101133-21	AE-101133-21	AE-101133-21	AE-101133-21
6		Drain Pan - Vertical	See RCSL Coil Parts List					
7		Drain Pan - Horizontal	See RCSL Coil Parts List					
8		Plate - Block Off	AE-100455-01	AE-100455-01	AE-100455-01	AE-100455-01	AE-100455-01	AE-100455-01
9		Cabinet Brace	AE-101134-02	AE-101134-02	AE-101134-02	AE-101134-02	AE-101134-02	AE-101134-02
10		Middle Brace	AE-101054-01	AE-101054-01	AE-101054-01	AE-101054-01	AE-101054-01	AE-101054-01
13a		Heat Barrier	AE-100683-02	AE-100683-02	AE-100683-02	AE-100683-02	AE-100683-03	AE-100683-03
13b		Heat Barrier Side (2)	AE-104241-01	AE-104241-01	AE-104241-01	AE-104241-01	AE-104241-01	AE-104241-01
		Insulation Retainer Rod (2)	45-102868-02	45-102868-02	45-102868-02	45-102868-02	45-102868-02	45-102868-02

No.	Notes	MODEL	HFE	HFE	HFE	HFE	HFE	HFE
		CAPACITY	36	36	42	42	48	48
		CABINET SIZE	17	17	21	21	21	21
		CONFIGURATION	GP	GP	GP	GP	GP	GP
		VOLTAGE	0	1	0	1	0	1
		VARIATION	A	A	A	A	A	A
PANELS, SHEET METAL, MISCELLANEOUS								
1		Cabinet	AE-100682-01	AE-100682-01	AE-100682-03	AE-100682-03	AE-100682-03	AE-100682-03
2		Coil Door	AE-100685-22	AE-100685-22	AE-100685-24	AE-100685-24	AE-100685-24	AE-100685-24
3		Top Cover Plate	AE-100686-01	AE-100686-01	AE-100686-02	AE-100686-02	AE-100686-02	AE-100686-02
4		Blower Door	AE-100684-21	AE-100684-21	AE-100684-22	AE-100684-22	AE-100684-22	AE-100684-22
5		Access Panel	AE-101133-21	AE-101133-21	AE-101133-21	AE-101133-21	AE-101133-21	AE-101133-21
6		Drain Pan - Vertical	See RCSL Coil Parts List					
7		Drain Pan - Horizontal	See RCSL Coil Parts List					
8		Plate - Block Off	AE-100455-01	AE-100455-01	AE-100455-01	AE-100455-01	AE-100455-01	AE-100455-01
9		Cabinet Brace	AE-101134-02	AE-101134-02	AE-101134-03	AE-101134-03	AE-101134-03	AE-101134-03
10		Middle Brace	AE-101054-01	AE-101054-01	AE-101054-02	AE-101054-02	AE-101054-02	AE-101054-02
13a		Heat Barrier	AE-100683-03	AE-100683-03	AE-100683-06	AE-100683-06	AE-100683-06	AE-100683-06
13b		Heat Barrier Side (2)	AE-104241-01	AE-104241-01	AE-104241-01	AE-104241-01	AE-104241-01	AE-104241-01
		Insulation Retainer Rod (2)	45-102868-02	45-102868-02	45-102868-03	45-102868-03	45-102868-03	45-102868-03

No.	Notes	MODEL	HFE	HFE	HFE	HFE	HFE	HFE
		CAPACITY	18	18	24	24	30	30
		CABINET SIZE	17	17	17	17	17	17
		CONFIGURATION	GP	GP	GP	GP	GP	GP
		VOLTAGE	0	1	0	1	0	1
		VARIATION	A	A	A	A	A	A
ELECTRICAL GROUP								
17	Stk	Transformer	46-101944-02	46-101944-02	46-101944-02	46-101944-02	46-101944-02	46-101944-02
18	Stk	Control Board - Before M3807	47-100436-84A	47-100436-84J	47-100436-84A	47-100436-84J	47-100436-84A	47-100436-84J
18	Stk	Control Board - After M3807	47-100436-05	47-100436-05	47-100436-05	47-100436-05	47-100436-05	47-100436-05
	Stk	Fuse	44-101986-01	44-101986-01	44-101986-01	44-101986-01	44-101986-01	44-101986-01
		Relay	N/A	N/A	N/A	N/A	N/A	N/A
		Wiring Harness - Before M3807 4 Pin Molex to 2 stripped wires, 2 terminals	N/A	45-24371-43	N/A	45-24371-43	N/A	45-24371-43
		Wiring Harness - Before M3807 5 Pin Molex to 5 stripped wires (For T-Stat)	45-102645-01	N/A	45-102645-01	N/A	45-102645-01	N/A
		Wiring Harness - After M3807 5 Pin Molex to 3 stripped wires (For T-Stat)	45-102645-02	N/A	45-102645-02	N/A	45-102645-02	N/A
		Wiring Harness - After M3807 5 Pin Molex to 5 stripped wires	N/A	45-102645-01	N/A	45-102645-01	N/A	45-102645-01
11		Terminal Block	45-23222-02	45-23222-02	45-23222-02	45-23222-02	45-23222-02	45-23222-02

No.	Notes	MODEL	HFE	HFE	HFE	HFE	HFE	HFE
		CAPACITY	36	36	42	42	48	48
		CABINET SIZE	17	17	21	21	21	21
		CONFIGURATION	GP	GP	GP	GP	GP	GP
		VOLTAGE	0	1	0	1	0	1
		VARIATION	A	A	A	A	A	A
ELECTRICAL GROUP								
17	Stk	Transformer	46-101944-02	46-101944-02	46-101944-02	46-101944-02	46-101944-02	46-101944-02
18	Stk	Control Board - Before M3807	47-100436-84A	47-100436-84J	47-100436-84A	47-100436-84J	47-100436-84A	47-100436-84J
18	Stk	Control Board - After M3807	47-100436-05	47-100436-05	47-100436-05	47-100436-05	47-100436-05	47-100436-05
	Stk	Fuse	44-101986-01	44-101986-01	44-101986-01	44-101986-01	44-101986-01	44-101986-01
		Relay	N/A	N/A	N/A	N/A	N/A	N/A
		Wiring Harness - Before M3807 4 Pin Molex to 2 stripped wires, 2 terminals	N/A	45-24371-43	N/A	45-24371-43	N/A	45-24371-43
		Wiring Harness - Before M3807 5 Pin Molex to 5 stripped wires (For T-Stat)	45-102645-01	N/A	45-102645-01	N/A	45-102645-01	N/A
		Wiring Harness - After M3807 5 Pin Molex to 3 stripped wires (For T-Stat)	45-102645-02	N/A	45-102645-02	N/A	45-102645-02	N/A
		Wiring Harness - After M3807 5 Pin Molex to 5 stripped wires	N/A	45-102645-01	N/A	45-102645-01	N/A	45-102645-01
11		Terminal Block	45-23222-02	45-23222-02	45-23222-02	45-23222-02	45-23222-02	45-23222-02

No.	Notes	MODEL	HFE					
		CAPACITY	48					
		CABINET SIZE	24					
		CONFIGURATION	GP					
		VOLTAGE	1					
		VARIATION	A					
ELECTRICAL GROUP								
17	Stk	Transformer	46-101944-02					
18	Stk	Control Board - Before M3807	47-100436-84J					
18	Stk	Control Board - After M3807	47-100436-05					
	Stk	Fuse	44-101986-01					
		Relay	N/A					
		Wiring Harness - Before M3807 4 Pin Molex to 2 stripped wires, 2 terminals	45-24371-43					
		Wiring Harness - Before M3807 5 Pin Molex to 5 stripped wires (For T-Stat)	N/A					
		Wiring Harness - After M3807 5 Pin Molex to 3 stripped wires (For T-Stat)	N/A					
		Wiring Harness - After M3807 5 Pin Molex to 5 stripped wires	45-102645-01					
11		Terminal Block	45-23222-02					

No.	Notes	MODEL	HFE	HFE	HFE	HFE	HFE	HFE
		CAPACITY	18	18	24	24	30	30
		CABINET SIZE	17	17	17	17	17	17
		CONFIGURATION	GP	GP	GP	GP	GP	GP
		VOLTAGE	0	1	0	1	0	1
		VARIATION	A	A	A	A	A	A
BLOWER GROUP								
15	Stk	Blower Assembly (Includes items 16-22) -Before M3807	AS-101929-81	AS-101931-81	AS-101929-82	AS-101931-82	AS-101929-83	AS-101931-83
15	Stk	Blower Assembly (Includes items 16-22) -After M3807	AS-101929-01	AS-101931-01	AS-101929-02	AS-101931-02	AS-101929-03	AS-101931-03
16		Mounting Bracket - Control Board	AE-101049-01	AE-101049-01	AE-101049-01	AE-101049-01	AE-101049-01	AE-101049-01
17		Transformer	See Electrical Group					
18		Control Board	See Electrical Group					
19		Blower Housing w/Wheel	70-101729-01	70-101729-01	70-101729-01	70-101729-01	70-101729-02	70-101729-02
	Stk	Blower Wheel	703012	703012	703012	703012	703014	703014
20		Motor Mount - Band	70-19927-04	70-19927-04	70-19927-04	70-19927-04	70-19927-04	70-19927-04
21		Motor Mount - Arm (4)	70-19929-10	70-19929-10	70-19929-10	70-19929-10	70-19929-10	70-19929-10
22	Stk	Blower Motor (PSC)	51-102175-01	51-101728-01	51-102175-02	51-102500-07	51-102175-03	51-101728-03
	Stk	Capacitor - Blower Motor	43-101666-55	43-101666-55	43-100510-58	43-101666-55	43-100510-56	43-100510-56
		Capacitor Strap	AE-50892-12	AE-50892-12	AE-50892-12	AE-50892-12	AE-50892-12	AE-50892-12

No.	Notes	MODEL	HFE	HFE	HFE	HFE	HFE	HFE
		CAPACITY	36	36	42	42	48	48
		CABINET SIZE	17	17	21	21	21	21
		CONFIGURATION	GP	GP	GP	GP	GP	GP
		VOLTAGE	0	1	0	1	0	1
		VARIATION	A	A	A	A	A	A
BLOWER GROUP								
15	Stk	Blower Assembly (Includes items 16-22) -Before M3807	AS-101929-84	AS-101931-84	AS-101929-85	AS-101931-85	AS-101929-86	AS-101931-86
15	Stk	Blower Assembly (Includes items 16-22) -After M3807	AS-101929-04	AS-101931-04	AS-101929-05	AS-101931-05	AS-101929-06	AS-101931-06
16		Mounting Bracket - Control Board	AE-101049-01	AE-101049-01	AE-101049-01	AE-101049-01	AE-101049-01	AE-101049-01
17		Transformer	See Electrical Group					
18		Control Board	See Electrical Group					
19		Blower Housing w/Wheel	70-101729-02	70-101729-02	70-101729-03	70-101729-03	70-101729-03	70-101729-03
	Stk	Blower Wheel	703014	703014	703013	703013	703013	703013
20		Motor Mount - Band	70-19927-04	70-19927-04	70-19927-04	70-19927-04	70-19927-04	70-19927-04
21		Motor Mount - Arm (4)	70-19929-10	70-19929-10	70-19929-10	70-19929-10	70-19929-10	70-19929-10
22	Stk	Blower Motor (PSC)	51-102175-04	51-101728-04	51-102175-05	51-101728-05	51-102175-06	51-101728-06
	Stk	Capacitor - Blower Motor	43-100509-43	43-100509-43	43-101666-57	43-101666-57	43-101666-57	43-101666-57
		Capacitor Strap	AE-50892-12	AE-50892-12	AE-50892-12	AE-50892-12	AE-50892-12	AE-50892-12

No.	Notes	MODEL	HFE					
		CAPACITY	48					
		CABINET SIZE	24					
		CONFIGURATION	GP					
		VOLTAGE	1					
		VARIATION	A					
BLOWER GROUP								
15	Stk	Blower Assembly (Includes items 16-22) Before M3807	AS-101931-86					
15	Stk	Blower Assembly (Includes items 16-22) After M3807	AS-101931-06					
16		Mounting Bracket - Control Board	AE-101049-01					
17		Transformer	See Electrical Group					
18		Control Board	See Electrical Group					
19		Blower Housing w/Wheel	70-101729-03					
	Stk	Blower Wheel	703013					
20		Motor Mount - Band	70-19927-04					
21		Motor Mount - Arm (4)	70-19929-10					
22	Stk	Blower Motor (PSC)	51-101728-06					
	Stk	Capacitor - Blower Motor	43-101666-57					
		Capacitor Strap	AE-50892-12					

No.	Notes	MODEL CAPACITY CABINET SIZE VOLTAGE	HFE 18/24 17 0/1	HFE 30/36 17 0/1	HFE 36 21 1	HFE 42/48 21 0/1	HFE 48 24 1	
COIL GROUP								
12		Replacement Coil w/TXV - Before Date Code Shown	RCSL-HM2417AU (4009)	RCSL-HM3617AU (0809)	RCSL-HM3621AU (0809)	RCSL-HM4821AU (2309)	RCSL-HM4824AU (0809)	
12		Replacement Coil w/TXV - After Date Code Shown	RCSL-HU2417CU (4009)	RCSL-HU3617CU (0809)	RCSL-HM3621AU (0809)	RCSL-HU4821CU (2309)	RCSL-HM4824AU (0809)	
		Horizontal Adapter Kit	RXHH-A02	RXHH-A03	RXHH-A03	RXHH-A04	N/A	
		Drain Pan	See specified RCSL Coil Parts List					
		TXV	See specified RCSL Coil Parts List					

No.	Notes	MODEL CAPACITY CABINET SIZE VOLTAGE	HFE 18/24 17 0/1	HFE 30/36 17 0/1	HFE 36 21 1	HFE 42/48 21/24 0/1	
HEATER KITS							
		Heater Kit - 3kW/208-240/1	RXBH-17A03J RXBH-1724A03J RXBH-1724B03J RXBH-1724C03J	RXBH-17A03J RXBH-1724A03J RXBH-1724B03J RXBH-1724C03J	N/A	N/A	
		Heater Kit - 5kW/208-240/1	RXBH-17A05J RXBH-1724A05J RXBH-1724B05J RXBH-1724C05J	RXBH-17A05J RXBH-1724A05J RXBH-1724B05J RXBH-1724C05J	RXBH-24A05J RXBH-1724A05J RXBH-1724B05J RXBH-1724C05J	RXBH-24A05J RXBH-1724A05J RXBH-1724B05J RXBH-1724C05J	
		Heater Kit - 7kW/208-240/1	RXBH-17A07J RXBH-1724A07J RXBH-1724B07J RXBH-1724C07J	RXBH-17A07J RXBH-1724A07J RXBH-1724B07J RXBH-1724C07J	RXBH-24A07J RXBH-1724A07J RXBH-1724B07J RXBH-1724C07J	RXBH-24A07J RXBH-1724A07J RXBH-1724B07J RXBH-1724C07J	
		Heater Kit - 10kW/208-240/1	RXBH-17A10J RXBH-1724A10J RXBH-1724B10J RXBH-1724C10J	RXBH-17A10J RXBH-1724A10J RXBH-1724B10J RXBH-1724C10J	RXBH-24A10J RXBH-1724A10J RXBH-1724B10J RXBH-1724C10J	RXBH-24A10J RXBH-1724A10J RXBH-1724B10J RXBH-1724C10J	
		Heater Kit - 13kW/208-240/1	RXBH-17A13J RXBH-1724A13J	RXBH-17A13J RXBH-1724A13J	N/A	N/A	
		Heater Kit - 15kW/208-240/1	N/A	RXBH-17A15J RXBH-1724A15J	RXBH-24A15J RXBH-1724A15J	RXBH-24A15J RXBH-1724A15J	
		Heater Kit - 18kW/208-240/1	N/A	RXBH-17A18J RXBH-1724A18J	RXBH-24A18J RXBH-1724A18J	RXBH-24A18J RXBH-1724A18J	
		Heater Kit - 20kW/208-240/1	N/A	N/A	N/A	RXBH-24A20J	
		Heater Kit - 25kW/208-240/1	N/A	N/A	N/A	RXBH-24A25J	
		Heater Kit - 7kW/208-240/3	RXBH-17A07C RXBH-1724A07C	RXBH-17A07C RXBH-1724A07C	RXBH-24A07C RXBH-1724A07C	RXBH-24A07C RXBH-1724A07C	
		Heater Kit - 10kW/208-240/3	RXBH-17A10C RXBH-1724A10C	RXBH-17A10C RXBH-1724A10C	RXBH-24A10C RXBH-1724A10C	RXBH-24A10C RXBH-1724A10C	
		Heater Kit - 13kW/208-240/3	RXBH-17A13C RXBH-1724A13C	RXBH-17A13C RXBH-1724A13C	N/A	N/A	
		Heater Kit - 15kW/208-240/3	N/A	RXBH-17A15C RXBH-1724A15C	RXBH-24A15C RXBH-1724A15C	RXBH-24A15C RXBH-1724A15C	
		Heater Kit - 18kW/208-240/3	N/A	RXBH-17A18C RXBH-1724A18C	RXBH-24A18C RXBH-1724A18C	RXBH-24A18C RXBH-1724A18C	
		Heater Kit - 20kW/208-240/3	N/A	N/A	N/A	RXBH-24A20C	
		Heater Kit - 25kW/208-240/3	N/A	N/A	N/A	RXBH-24A25C	

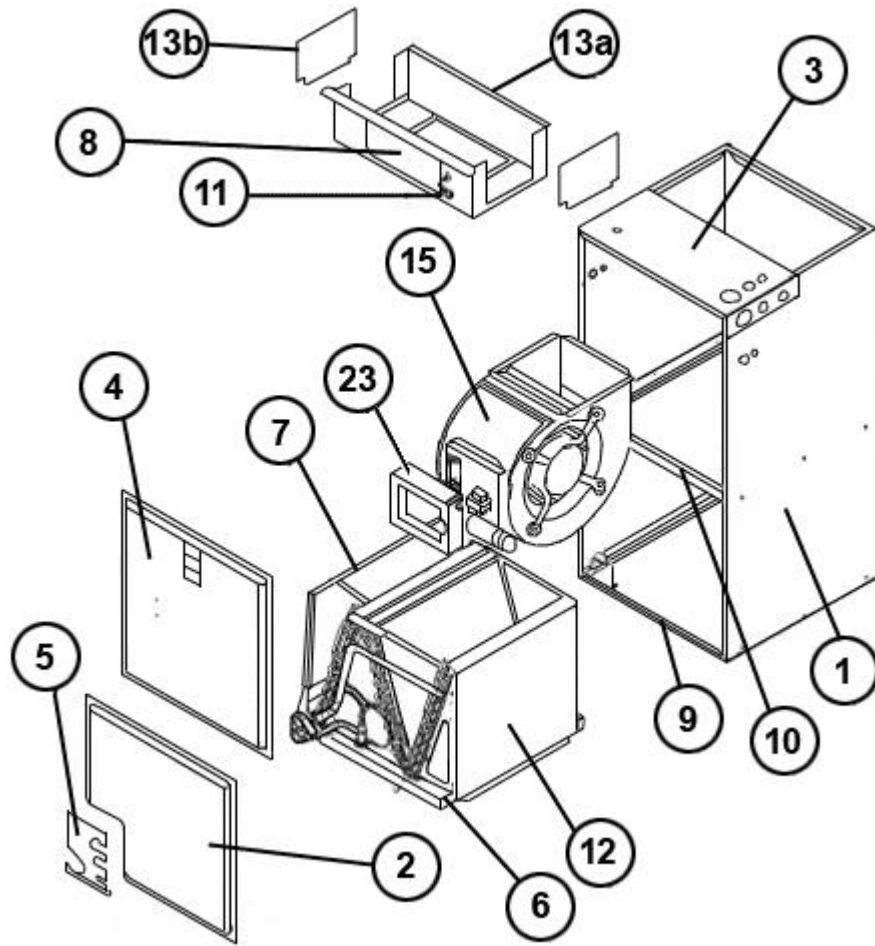

Exploded View



Blower Assembly

NOTES

Stk It is recommended that stock be maintained for this part.
N/A Not Applicable