

This Owner's Manual is provided and hosted by [Appliance Factory Parts](#).



COMFORT-AIRE TGRG-C81 Owner's Manual

[Shop genuine replacement parts for COMFORT-AIRE
TGRG-C81](#)



[Find Your COMFORT-AIRE HVAC Parts - Select From 1486 Models](#)

----- Manual continues below -----

TGRG-C

HEAT CONTROLLER, INC.

Parts List
29-February-2012



This parts list is current as of the above revision date.

Form Number: 92-42810-TGRG-C

Table of Contents

Model Explanation	Page 3
Parts Numbers	
Panels - Miscellaneous 024-036	Page 4
Panels - Miscellaneous 042-060	Page 5
Electrical Group	Page 6
Fan Group	Page 6
Blower Group	Page 6
Coil Parts	Page 7
Compressor Group	Page 7
Heat Exchanger-Burner Group	Page 8
Gas Controls	Page 9
Accessories	Page 9
Orifice Selection Chart	Page 10
Drawings/Photographs	
Exploded View	Page 11
Control Access Panel Detail	Page 12
Electrical Control Box	Page 13
Blower Assembly	Page 14
Evaporator Coil Assembly	Page 15
Condenser Coil	Page 16
Compressor Assembly	Page 17
Heat Exchanger Assembly	Page 18
Burner Assembly	Page 19
Notes	Page 20

MODEL NUMBER EXPLANATION

T	G	R	G	2	4	C	-	1	K	-	4	0
(1)				(2)		(3)		(4)			(5)	

- (1) DESIGN SERIES
- (2) COOLING CAPACITY (BTU/HR)
- (3) TECHNICAL VARIATIONS
- (4) DESIGN SERIES
- (5) HEATING CAPACITY - (MBH)

SERIAL NUMBER EXPLANATION

1	R	A	1	2	3	4	A	D	A	A	F	2	6	9	5	0	0	0	1
(1)	(2)	(3)				(4)	(5)	(6)	(7)	(8)	(9)	(10)		(11)					

- (1) GAS CODE
- (2) BLOWER CONTROL BOARD
- (3) COMPRESSOR IDENTIFICATION NUMBER
- (4) IGNITION DEVICE
- (5) INDUCER BLOWER
- (6) HEAT EXCHANGER
- (7) TECHNOLOGY VARIATIONS
- (8) PLANT
- (9) WEEK
- (10) YEAR
- (11) PRODUCTION NUMBER

No.	Notes	MODEL TECHNICAL VARIATION COOLING CAPACITY	TGRG C 24	TGRG C 30	TGRG C 36
PANELS, MISCELLANEOUS PARTS					
1		Front Base Pan	AS-58628-07C	AS-58628-07C	AS-58628-07C
2		Base Rail (2)	AE-58562-03	AE-58562-03	AE-58562-03
3		Base Rail (2)	AE-58562-04	AE-58562-04	AE-58562-04
4		Back Base Pan	AS-58607-64	AS-58607-64	AS-58607-64
5		Blower Shelf	AS-58630-01	AS-58630-01	AS-58630-01
6		Blower Shelf Transition	AS-58607-19	AS-58607-19	AS-58607-19
7		Divider Panel	AS-58607-03	AS-58607-03	AS-58607-03
8		Bulkhead Assembly	AS-58607-62	AS-58607-62	AS-58607-55
9		Exhaust Hood	AS-58629-01C	AS-58629-01C	AS-58629-01C
10		Combustion Air Inlet Hood	AS-58599-01C	AS-58599-01C	AS-58599-01C
11		Corner Post	AS-58607-40C	AS-58607-40C	AS-58607-40C
12		Blower Access Panel	AS-58607-09C	AS-58607-09C	AS-58607-09C
13		End Panel	AS-58607-04C	AS-58607-04C	AS-58607-04C
14		Supply Cover - Downflow	AS-58607-06C	AS-58607-06C	AS-58607-06C
14		Supply Cover - Side Option	AS-58607-35C	AS-58607-35C	AS-58607-35C
15		Return Cover - Downflow	AS-58607-05C	AS-58607-05C	AS-58607-05C
15		Return Cover - Side Option	AS-58607-34C	AS-58607-34C	AS-58607-34C
16		Top Panel	AS-58607-60C	AS-58607-60C	AS-58607-58C
17		Grille	95-100906-08	95-100906-08	95-100906-08
18		Filter Access Panel	AS-58607-08C	AS-58607-08C	AS-58607-08C
19		Condenser Louver Panel	AS-58607-61C	AS-58607-61C	AS-58607-61C
20		Center Post	AS-58569-05C	AS-58569-05C	AS-58569-05C
21		Control Access Panel	AS-58607-20C	AS-58607-20C	AS-58607-20C
22		Control Box - (w/o components)	AE-58597-01	AE-58597-01	AE-58597-01
23		Control Box Cover	AE-58598-01	AE-58598-01	AE-58598-01
24		Furnace Shelf	AS-58607-11	AS-58607-11	AS-58607-11
25		Burner Floor	AE-58594-01	AE-58594-01	AE-58594-01
26		Exhaust Transition	AS-58607-36	AS-58607-36	AS-58607-36
27		Bulkhead Valve (2)	61-22369-04	61-22369-04	61-22369-04
28		Bulkhead Valve Locknut (2)	63-22368-01	63-22368-01	63-22368-01
		Bulkhead Valve Cap (2)	83-100635-01	83-100635-01	83-100635-01
		Heat Exchanger Tube Support	AE-58590-01	AE-58590-01	AE-58590-01
		Grommet - Gas Supply Piping	56-22114-01	56-22114-01	56-22114-01

No.	Notes	MODEL TECHNICAL VARIATION COOLING CAPACITY	TGRG C 42	TGRG C 048	TGRG C 60
PANELS, MISCELLANEOUS PARTS					
1		Front Base Pan	AS-58628-07C	AS-58628-07C	AS-58628-07C
2		Base Rail (2)	AE-58562-03	AE-58562-03	AE-58562-03
3		Base Rail (2)	AE-58562-04	AE-58562-04	AE-58562-04
4		Back Base Pan	AS-58607-64	AS-58607-64	AS-58607-64
5		Blower Shelf	AS-58630-01	AS-58630-01	AS-58630-01
6		Blower Shelf Transition	AS-58607-19	AS-58607-19	AS-58607-19
7		Divider Panel	AS-58607-03	AS-58607-03	AS-58607-03
8		Bulkhead Assembly	AS-58607-57	AS-58607-57	AS-58607-57
9		Exhaust Hood	AS-58629-01C	AS-58629-01C	AS-58629-01C
10		Combustion Air Inlet Hood	AS-58599-01C	AS-58599-01C	AS-58599-01C
11		Corner Post	AS-58607-46C	AS-58607-46C	AS-58607-46C
12		Blower Access Panel	AS-58607-47C	AS-58607-47C	AS-58607-47C
13		End Panel	AS-58607-48C	AS-58607-48C	AS-58607-48C
14		Supply Cover - Downflow	AS-58607-06C	AS-58607-06C	AS-58607-06C
14		Supply Cover - Side Option	AS-58607-35C	AS-58607-35C	AS-58607-35C
15		Return Cover - Downflow	AS-58607-05C	AS-58607-05C	AS-58607-05C
15		Return Cover - Side Option	AS-58607-34C	AS-58607-34C	AS-58607-34C
16		Top Panel	AS-58607-54C	AS-58607-54C	AS-58607-54C
17		Grille	95-100906-08	95-100906-08	95-100906-08
18		Filter Access Panel	AS-58607-49C	AS-58607-49C	AS-58607-49C
19		Condenser Louver Panel	AS-58607-56C	AS-58607-56C	AS-58607-56C
20		Center Post	AS-58569-07C	AS-58569-07C	AS-58569-07C
21		Control Access Panel	AS-58607-50C	AS-58607-50C	AS-58607-50C
22		Control Box - (w/o components)	AE-58597-01	AE-58597-01	AE-58597-01
23		Control Box Cover	AE-58598-01	AE-58598-01	AE-58598-01
24		Furnace Shelf	AS-58607-11	AS-58607-11	AS-58607-11
25		Burner Floor	AE-58594-01	AE-58594-01	AE-58594-01
26		Exhaust Transition	AS-58607-36	AS-58607-36	AS-58607-36
27		Bulkhead Valve (2)	61-22369-04	61-22369-04	61-22369-04
28		Bulkhead Valve Locknut (2)	63-22368-01	63-22368-01	63-22368-01
		Bulkhead Valve Cap (2)	83-100635-01	83-100635-01	83-100635-01
		Heat Exchanger Tube Support	AE-58590-01	AE-58590-01	AE-58590-01
		Grommet - Gas Supply Piping	56-22114-01	56-22114-01	56-22114-01

No.	Notes	MODEL TECHNICAL VARIATION COOLING CAPACITY	TGRG	TGRG	TGRG	TGRG	TGRG	TGRG
			C 24	C 30	C 36	C 42	C 48	C 60
ELECTRICAL GROUP								
31	Stk	Induced Draft Blower w/Gasket	70-23641-01	70-23641-01	70-23641-01	70-23641-01	70-23641-01	70-23641-01
		Gasket - Induced Draft Blower	68-23643-01	68-23643-01	68-23643-01	68-23643-01	68-23643-01	68-23643-01
32	Stk	Comfort Alert Module	N/A	N/A	N/A	N/A	N/A	42-101504-02
33	Stk	Contactator	42-42728-03	42-42728-03	42-42728-03	42-42728-03	42-42728-03	42-42728-03
34	Stk	Pressure Switch	42-24335-20	42-24335-20	42-24335-20	42-24335-20	42-24335-20	42-24335-20
35	Stk	Transformer	46-100836-02	46-100836-02	46-100836-02	46-18788-05	46-18788-05	46-18788-05
36		Ground Lug	45-19000-01	45-19000-01	45-19000-01	45-19000-01	45-19000-01	45-19000-01
39		Integrated Furnace Control Board (IFC)	See Gas Controls					
57	Stk	Blower Relay	N/A	N/A	N/A	N/A	N/A	42-101208-02
73		Capacitor - Compressor/Fan	See Compressor Group					
		Capacitor - Blower Motor	See Blower Group					
84		Limit Control - Blower Shelf	See Heat Exchanger-Burner Group					
88		Limit Control - Roll Out	See Heat Exchanger-Burner Group					
		Compressor Wiring Harness (Molded Plug)	See Compressor Group					
		Wiring Harness - 9 pin to 9 insulated terminals	AS-102393-02	AS-102393-02	AS-102393-02	AS-102393-02	AS-102393-02	AS-102393-02
		Leadwire - from Flame Sensor to 9 pin Wiring Harness Plug	45-25323-02	45-25323-02	45-25323-02	45-25323-02	45-25323-02	45-25323-02
		Capacitor Adaptor Plate (2 in. round capacitor)	AE-54609-01	AE-54609-01	AE-54609-01	AE-54609-01	AE-54609-01	AE-54609-01
		Capacitor Adaptor Plate (2 in. X 1-1/4 in. oval capacitor)	AE-54609-02	AE-54609-02	AE-54609-02	AE-54609-02	AE-54609-02	AE-54609-02

No.	Notes	MODEL TECHNICAL VARIATION COOLING CAPACITY	TGRG	TGRG	TGRG	TGRG	TGRG	TGRG
			C 24	C 30	C 36	C 42	C 48	C 60
FAN GROUP								
37	Stk	Fan Motor	51-100998-24	51-100998-24	51-100998-24	51-100998-19	51-100998-19	51-100998-19
38	Stk	Fan Blade	70-101323-19	70-101323-19	70-101323-19	70-23594-02	70-23594-02	70-23594-02
73		Capacitor - Compressor/Fan	See Compressor Group					

No.	Notes	MODEL TECHNICAL VARIATION COOLING CAPACITY	TGRG	TGRG	TGRG	TGRG	TGRG	TGRG
			C 24	C 30	C 36	C 42	C 48	C 60
BLOWER GROUP								
	Stk	Blower Assembly (Includes items 51-56)	AS-58662-01	AS-58662-05	AS-58662-05	AS-58662-05	AS-58662-06	AS-58662-20
51		Housing	AS-58619-01	AS-58619-02	AS-58619-02	AS-58619-02	AS-58619-02	N/A
51		Housing w/Wheel	N/A	N/A	N/A	N/A	N/A	70-100840-02
51a		Transition	N/A	N/A	N/A	N/A	N/A	AE-102207-05
51b		Transition - Back	N/A	N/A	N/A	N/A	N/A	AE-102207-06
52	Stk	Blower Wheel	70-20218-01	70-18625-03	70-18625-03	70-18625-03	70-18625-03	703016
53		Cut-Off	AE-64401-10	AE-64401-06	AE-64401-06	AE-64401-06	AE-64401-06	N/A
54	Stk	Motor	51-23608-02	51-23609-04	51-23609-04	51-23609-04	51-23650-01	51-101984-03
		Motor Mounting Bracket Assembly (Includes items 55, 56)	AS-53148-03	AS-53148-04	AS-53148-04	AS-53148-04	AS-53148-04	N/A
55		Motor Band	70-19927-01	70-19927-01	70-19927-01	70-19927-01	70-19927-01	70-19927-03
56		Motor Arm Assembly (3)	70-19929-02	70-19929-02	70-19929-02	70-19929-02	70-19929-02	70-19929-09
57		Blower Relay	See Electrical Group					
	3	Resistor/Wire Assembly (Before F2608) - See Note 3	N/A	N/A	N/A	N/A	N/A	44-102333-01
79	Stk	Capacitor - Blower Motor	43-100496-04	43-100496-12	43-100496-12	43-100496-12	43-100496-45	N/A

No.	Notes	MODEL TECHNICAL VARIATION COOLING CAPACITY	TGRG C 24	TGRG C 30	TGRG C 36	TGRG C 42	TGRG C 48	TGRG C 60
COIL GROUP								
CONDENSER COIL:								
61	Stk	Condenser Coil	AS-101997-03	AS-101997-03	AS-101993-03	AS-101994-03	AS-101996-01	AS-101996-01
		Distributor Assembly	AS-101689-02	AS-101689-02	AS-101689-02	N/A	AS-101689-01	AS-101689-01
		Distributor - (Two way - 3/8 in. to 3/8 in.)	83-17467-02	83-17467-02	83-17467-02	N/A	83-17467-02	83-17467-02
		Access Valve Body (2)	61-18542-01	61-18542-01	61-18542-01	61-18542-01	61-18542-01	61-18542-01
		Access Valve Core (2)	61-18551-01	61-18551-01	61-18551-01	61-18551-01	61-18551-01	61-18551-01
78	Stk	Filter Drier - Liquid Line	83-22755-05	83-22755-05	83-22755-05	83-22755-05	83-22755-05	83-22755-05
EVAPORATOR COIL:								
62	Stk	Evaporator Coil w/Drain Pan	AS-102660-04	AS-102660-04	AS-102660-03	AS-102660-02	AS-102660-01	AS-102660-01
63		Drain Pan Grommet	56-23601-01	56-23601-01	56-23601-01	56-23601-01	56-23601-01	56-23601-01
64	Stk	Drain Pan - Before F4507	AS-58607-32	AS-58607-32	AS-58607-32	AS-58607-32	AS-58607-32	AS-58607-32
64	Stk	Drain Pan - After F4507	68-23602-02	68-23602-02	68-23602-02	68-23602-02	68-23602-02	68-23602-02
64a		Drain Trap (Attached to Drain Pan)	68-23603-01	68-23603-01	68-23603-01	68-23603-01	68-23603-01	68-23603-01
65		Auxiliary Drain Pipe	AE-58611-01	AE-58611-01	AE-58611-01	AE-58611-01	AE-58611-01	AE-58611-01
66	Stk	Flowcheck Distributor/Piston Assembly	61-102106-12	61-102106-12	61-102106-14	61-102108-14	61-102108-17	61-102108-17
67	Stk	TXV	61-102211-01	61-102211-02	61-102211-02	61-102211-03	61-102211-04	61-102211-05
68		Condensate Shield	AE-101751-01	AE-101751-01	AE-101751-01	AE-101751-02	AE-101751-02	AE-101751-02
68a		Condensate Barrier	AE-100544-01	AE-100544-01	AE-100544-01	AE-100544-02	AE-100544-02	AE-100544-02

No.	Notes	MODEL TECHNICAL VARIATION COOLING CAPACITY	TGRG C 24	TGRG C 30	TGRG C 36	TGRG C 42	TGRG C 48	TGRG C 60
COMPRESSOR GROUP								
Compressor ID:			7405	7406	7409	7411	7414	7417
71	Stk	Compressor	55-102045-01S	55-102045-02S	55-102045-03S	55-102045-12S	55-102045-09S	55-23156-11S
72		Grommet (4)	56-18518-16	56-18518-16	56-18518-16	56-18518-06	56-18518-06	56-18518-06
	Stk	Compressor Wiring Harness (Molded Plug)	45-100834-80	45-100834-80	45-100834-80	45-100834-80	45-100834-80	45-100834-80
	Stk	Compressor Wiring Harness (Low Voltage)	N/A	N/A	N/A	N/A	N/A	45-101723-01
73	Stk	Capacitor - Compressor/Fan	43-26271-09	43-26271-09	43-26271-41	43-101665-42	43-101662-47	43-26271-30
74		Capacitor - Start	N/A	N/A	N/A	N/A	N/A	43-17075-04
75		Relay - Start	N/A	N/A	N/A	N/A	N/A	42-18282-26
76		High Pressure Control	N/A	N/A	N/A	N/A	N/A	47-102290-01
77		Low Pressure Control	N/A	N/A	N/A	N/A	N/A	47-101529-05

No.	Notes	MODEL	TGRG	TGRG	TGRG	TGRG
		TECHNICAL VARIATION	C	C	C	C
		HEATING CAPACITY	40	60/61	80/81	100/101
HEAT EXCHANGER, BURNER / MANIFOLD						
81	Stk	Heat Exchanger (Includes Center Panel and Turbulators)	AS-58632-01	AS-58632-02	AS-58632-03	AS-58632-04
82		Turbulators	AE-58591-02 (2)	AE-58591-02 (3)	AE-58591-02 (4)	AE-58591-02 (5)
		Collector Box Gasket	68-23644-01	68-23644-01	68-23644-01	68-23644-01
83		Collector Box	AE-58588-01	AE-58588-01	AE-58588-01	AE-58588-01
84	Stk	Limit Control - Blower Shelf	47-102436-02 (024)	47-102436-01 (024,030)	47-102436-01 (024-036)	47-102436-01 (030-060)
85		NOX Insert Assembly	N/A	N/A	N/A	N/A
86		Lower Burner Shield (NOX)	N/A	N/A	N/A	N/A
87		Radiation Shield	AE-58595-01	AE-58595-01	AE-58595-01	AE-58595-01
88	Stk	Limit - Manual Reset (Burner Compartment) (Before F3708)	47-100241-01	47-100241-01	47-100241-01	47-100241-01
88	Stk	Limit - Manual Reset (Burner Compartment) (After F3708)	47-22861-02	47-22861-02	47-22861-02	47-22861-02
89	Stk	Burner Tube w/Shield (Before F3708)	75-22840-02 (2)	75-22840-02 (3)	75-22840-02 (4)	75-22840-02 (5)
89	Stk	Burner Assembly (After F3708)	AS-60993-02	AS-60993-03	AS-60993-04	AS-60993-05
	Stk,2	One-piece Burner Retrofit Kit - See Note 2	AS-60993-82	AS-60993-83	AS-60993-84	AS-60993-85
90		Burner Support Bracket (2) (Before F3708)	AE-61588-01	AE-61588-01	AE-61588-01	AE-61588-01
90		Burner Support Bracket (2) (After F3708)	AE-61588-02	AE-61588-02	AE-61588-02	AE-61588-02
91		Burner Support - (Holds Burners between Burner Support Brackets) (Before F3708)	AE-58592-02	AE-58592-02	AE-58592-02	AE-58592-02
91		Burner Support - (Holds Burners between Burner Support Brackets) (After F3708)	AE-102438-01	AE-102438-01	AE-102438-01	AE-102438-01
92	Stk	Manifold Assembly	81-101154-01	81-101154-01	81-101154-01	81-101154-01
		Square Head Plug (Used on Manifold to plug extra holes)	81-23593-01 (1)	81-23593-01 (2)	81-23593-01 (1)	N/A
94		Burner Orifice - Natural Gas	See Orifice Selection Chart			
94		Burner Orifice - LP	See Orifice Selection Chart			
94		Number of Orifices	(2)	(3)	(4)	(5)
95	Stk	Flame Sensor	62-23543-02	62-23543-02	62-23543-02	62-23543-02
96	Stk	Ignition Electrode/Cable Assembly	62-23556-01	62-23556-01	62-23556-01	62-23556-01

No.	Notes	MODEL TECHNICAL VARIATION GAS CODE	TGRG C 1R	TGRG C 1X	TGRG C 2A	TGRG C 2G
GAS CONTROLS						
39	Stk	Integrated Furnace Control Board (IFC)	62-23599-02	62-23599-02	62-23599-02	62-23599-04
	Stk	Gas Valve - Natural Gas	60-22447-07	60-23490-01	60-24290-01	60-100394-02
	Stk,1	Gas Valve - LP	See Note 1	See Note 1	See Note 1	See Note 1
	Stk	LP Conversion Kit	EP-85H	EP-84W	EP-84W	EP-85H

No.	Notes	MODEL SIZE	TGRG ALL			
OPTIONS AND ACCESSORIES						
		Economizer - Downflow, 3 Position	RXRE-CAA30			
		Economizer - Downflow, Fully Modulating	RXRD-CAM10			
		Economizer - Horizontal Application, 3 Position	RXRE-CCA30			
		Economizer - Horizontal Application, Fully Modulating	RXRD-CCM10			
		Fresh Air Damper - Fixed, 35%	RXRF-FAA1			
		Fresh Air Damper - Motorized, 35%	RXRF-FAB1			
		Filter Kit	RXRY-B01			
		Low Ambient Control	RXRZ-B01			
		High Pressure Control	RXAB-E01			
		Low Pressure Control	RXAC-C01			

PACKAGE EQUIPMENT - ORIFICE SELECTION CHART - NATURAL GAS

CAUTION: Selection of the correct Natural Gas Orifice requires the following information for the specific installation:

- 1) Furnace Input Rating (BTU/HR)
- 2) Number of Burners
- 2) Altitude (ft.)

For detailed information and instructions for Orifice selection, see the Gas Furnace LP Conversion Kit Index and the latest edition of the National Fuel Gas Code Handbook, or the National Standard of Canada, Natural Gas and Propane Installation Code, CAN B149.1.

CAUTION: This information is provided for replacement purposes only. Conversion for operation at High Altitude must be done using the kit specified on the product specification sheet for the unit.

NOTE: This Orifice sizing chart is based on a Natural Gas heating value of 1075 BTU/cu. ft and a pressure setting of 3.5 in. water column.

NOTE: Factory installed orifices are calculated and sized based on a Natural Gas heating value of 1075 BTU/cu. ft. and an elevation of 0 - 2000 ft.

Furnace Input Rating (BTU/HR)	Canadian High Altitude Derated Input (BTU/HR)	Number of Burners	Elevation (ft.)					
			Country					
			0 - 2000 U.S.	2001 - 4000 U.S.	4001 - 6000 U.S.	8000+ U.S.	0 - 2000 Canada	2001 - 4500 Canada
40,000	36,000	2	62-22175-45	62-22175-47	62-22175-48	62-22175-49	62-22175-45	62-22175-15
60,000	54,000	3	62-22175-45	62-22175-47	62-22175-48	62-22175-49	62-22175-45	62-22175-15
72,000	N/A	4	62-22175-15	62-22175-49	62-22175-50	62-22175-51	62-22175-15	N/A
80,000	72,000	4	62-22175-45	62-22175-47	62-22175-48	62-22175-49	62-22175-45	62-22175-15
90,000	N/A	5	62-22175-15	62-22175-49	62-22175-50	62-22175-51	62-22175-15	N/A
100,000	90,000	5	62-22175-45	62-22175-47	62-22175-48	62-22175-49	62-22175-45	62-22175-15
120,000	108,000	6	62-22175-45	62-22175-47	62-22175-48	62-22175-49	62-22175-45	62-22175-15
135,000	121,500	6	62-22175-44	62-22175-45	62-22175-47	62-22175-48	62-22175-44	62-22175-45
150,000	135,000	6	62-22175-42	62-22175-43	62-22175-44	62-22175-45	62-22175-42	62-22175-44
180,000	N/A	9	62-22175-45	62-22175-47	62-22175-48	62-22175-49	62-22175-45	N/A
210,000	N/A	9	62-22175-43	62-22175-44	62-22175-45	62-22175-47	62-22175-43	N/A
210,000	N/A	10	62-22175-45	62-22175-47	62-22175-48	62-22175-49	62-22175-45	N/A
225,000	202,500	9	62-22175-42	62-22175-43	62-22175-44	62-22175-45	62-22175-42	62-22175-44
250,000	225,000	10	62-22175-42	62-22175-43	62-22175-44	62-22175-45	62-22175-42	62-22175-44
252,000	225,000	9	62-22175-40	62-22175-42	62-22175-43	62-22175-44	62-22175-40	62-22175-42
252,000	N/A	12	62-22175-45	62-22175-47	62-22175-48	62-22175-49	62-22175-45	N/A
290,000	N/A	14	62-22175-45	62-22175-47	62-22175-48	62-22175-49	62-22175-45	N/A
300,000	270,000	12	62-22175-42	62-22175-43	62-22175-44	62-22175-45	62-22175-42	62-22175-44
330,000	N/A	14	62-22175-43	62-22175-44	62-22175-45	62-22175-47	62-22175-43	N/A
350,000	315,000	14	62-22175-42	62-22175-43	62-22175-44	62-22175-45	62-22175-42	62-22175-44
400,000	360,000	14	62-22175-40	62-22175-42	62-22175-43	62-22175-44	62-22175-40	62-22175-42

PACKAGE EQUIPMENT - ORIFICE SELECTION CHART - LP

CAUTION: Selection of the correct LP Orifice requires the following information for the specific installation:

- 1) Furnace Input Rating (BTU/HR)
- 2) Number of Burners
- 2) Altitude (ft.)

For detailed information and instructions for Orifice selection, see the Gas Furnace LP Conversion Kit Index and the latest edition of the National Fuel Gas Code Handbook, or the National Standard of Canada, Natural Gas and Propane Installation Code, CAN B149.1.

CAUTION: This information is provided for replacement purposes only. Conversion to LP or for operation at High Altitude should be done using the kit(s) specified on the product specification sheet for the unit.

NOTE: This Orifice sizing chart is developed using the specified pressure setting of 10 in. water column instead of the 11.0 in water column used by the NFG and CANB149.1.

NOTE: Orifices supplied in the LP Conversion Kit are calculated and sized based on a heating value of 2500 BTU/cu. ft. and an elevation of 0 - 2000 ft.

Furnace Input Rating (BTU/HR)	Canadian High Altitude Derated Input (BTU/HR)	Number of Burners	Elevation (ft.)					
			Country					
			0 - 2000 U.S.	2001 - 4000 U.S.	4001 - 6000 U.S.	8000+ U.S.	0 - 2000 Canada	2001 - 4500 Canada
40,000	36,000	2	62-22175-55	62-22175-55	62-22175-56	62-22175-56	62-22175-55	62-22175-13
60,000	54,000	3	62-22175-55	62-22175-55	62-22175-56	62-22175-56	62-22175-55	62-22175-13
72,000	N/A	4	62-22175-13	62-22175-57	62-22175-57	62-22175-59	62-22175-13	N/A
80,000	72,000	4	62-22175-55	62-22175-55	62-22175-56	62-22175-56	62-22175-55	62-22175-13
90,000	N/A	5	62-22175-13	62-22175-57	62-22175-57	62-22175-59	62-22175-13	N/A
100,000	90,000	5	62-22175-55	62-22175-55	62-22175-56	62-22175-56	62-22175-55	62-22175-13
120,000	108,000	6	62-22175-55	62-22175-55	62-22175-56	62-22175-56	62-22175-55	62-22175-13
135,000	121,500	6	62-22175-54	62-22175-55	62-22175-55	62-22175-56	62-22175-54	62-22175-55
150,000	135,000	6	62-22175-54	62-22175-55	62-22175-55	62-22175-56	62-22175-54	62-22175-54
180,000	N/A	9	62-22175-55	62-22175-55	62-22175-56	62-22175-56	62-22175-55	N/A
210,000	N/A	9	62-22175-54	62-22175-55	62-22175-55	62-22175-56	62-22175-54	N/A
210,000	N/A	10	62-22175-55	62-22175-55	62-22175-56	62-22175-56	62-22175-55	N/A
225,000	202,500	9	62-22175-54	62-22175-55	62-22175-55	62-22175-56	62-22175-54	62-22175-54
250,000	225,000	10	62-22175-54	62-22175-55	62-22175-55	62-22175-56	62-22175-54	62-22175-54
252,000	225,000	9	62-22175-53	62-22175-54	62-22175-54	62-22175-55	62-22175-53	62-22175-54
252,000	N/A	12	62-22175-55	62-22175-55	62-22175-56	62-22175-56	62-22175-55	N/A
290,000	N/A	14	62-22175-55	62-22175-55	62-22175-56	62-22175-56	62-22175-55	N/A
300,000	270,000	12	62-22175-54	62-22175-55	62-22175-55	62-22175-56	62-22175-54	62-22175-54
330,000	N/A	14	62-22175-54	62-22175-55	62-22175-55	62-22175-56	62-22175-54	N/A
350,000	315,000	14	62-22175-54	62-22175-55	62-22175-55	62-22175-56	62-22175-54	62-22175-54
400,000	360,000	14	62-22175-53	62-22175-54	62-22175-54	62-22175-55	62-22175-53	62-22175-54

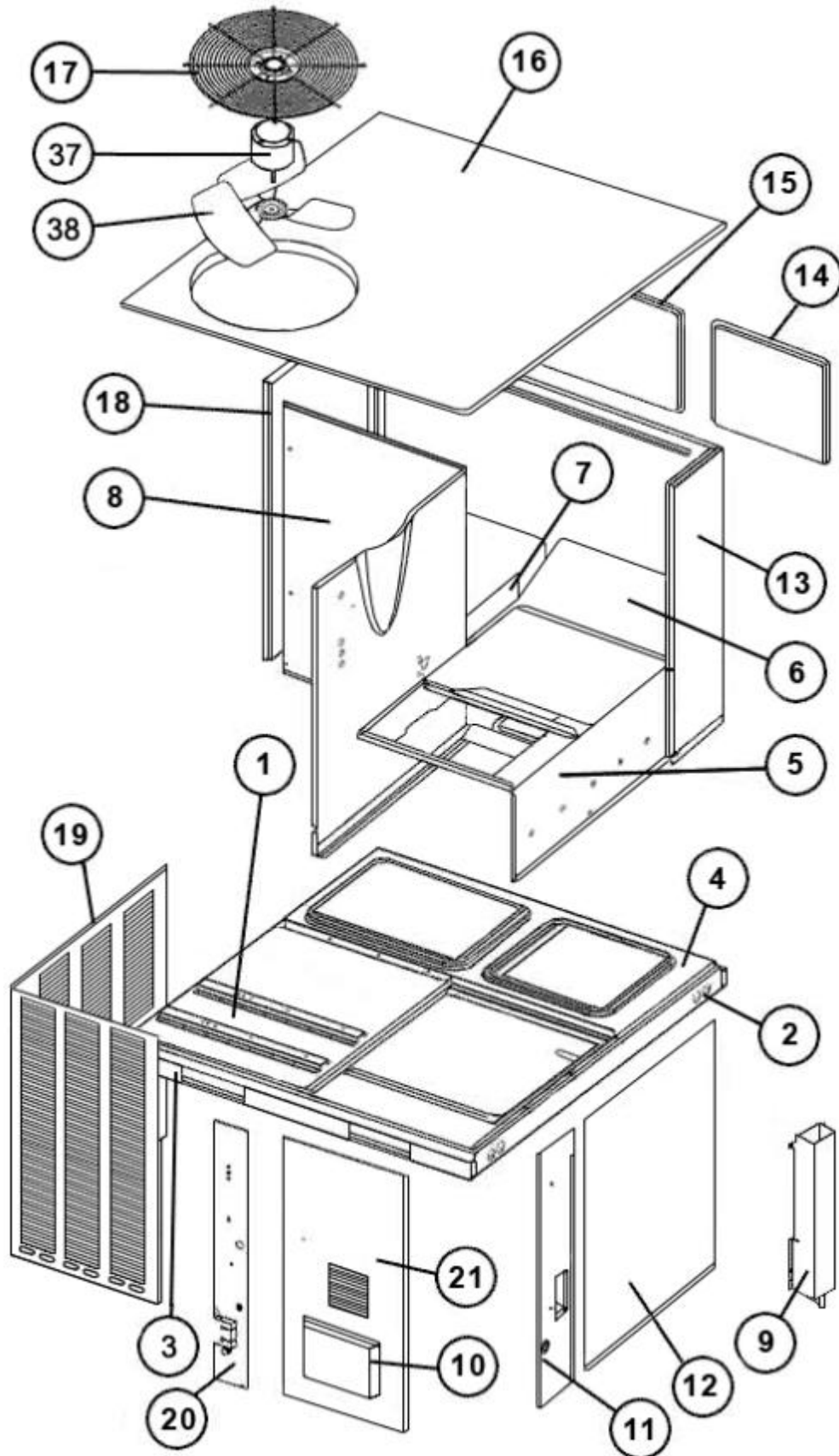

Exploded View

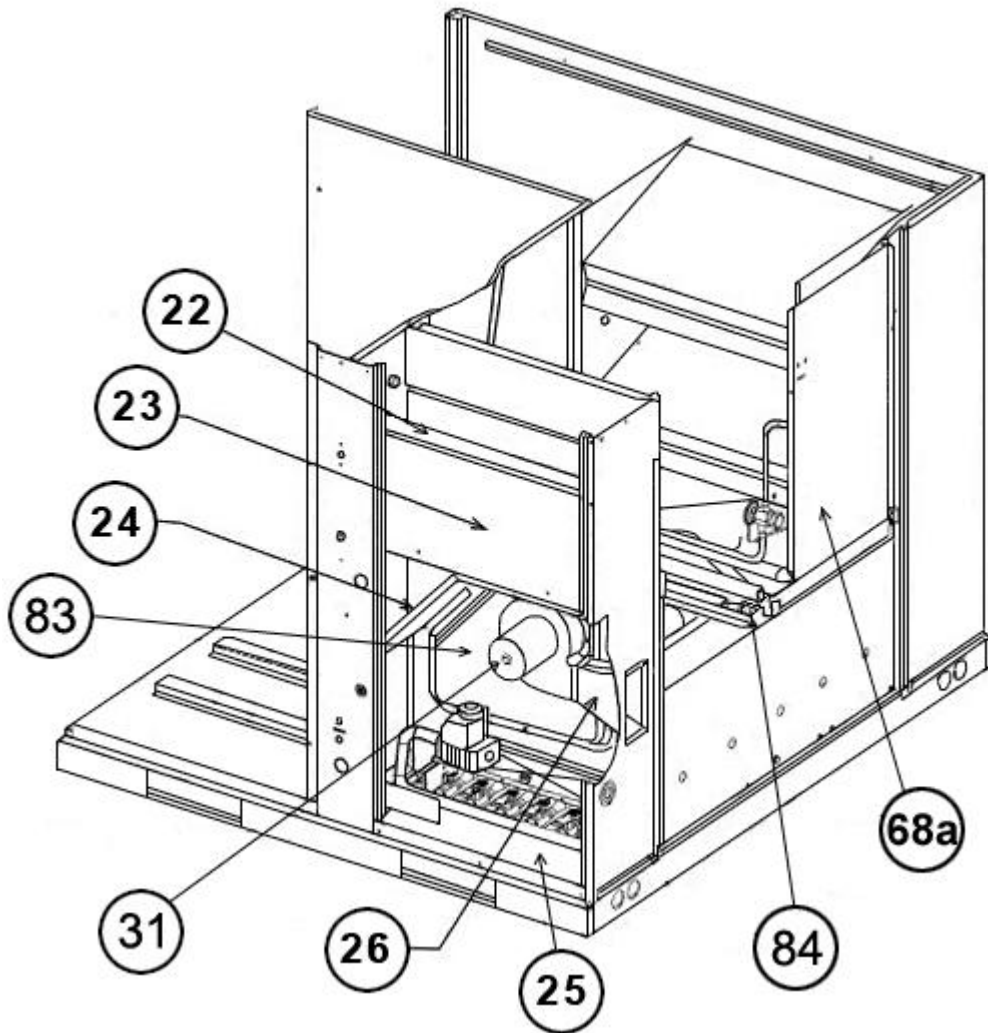

Control Access Panel Detail

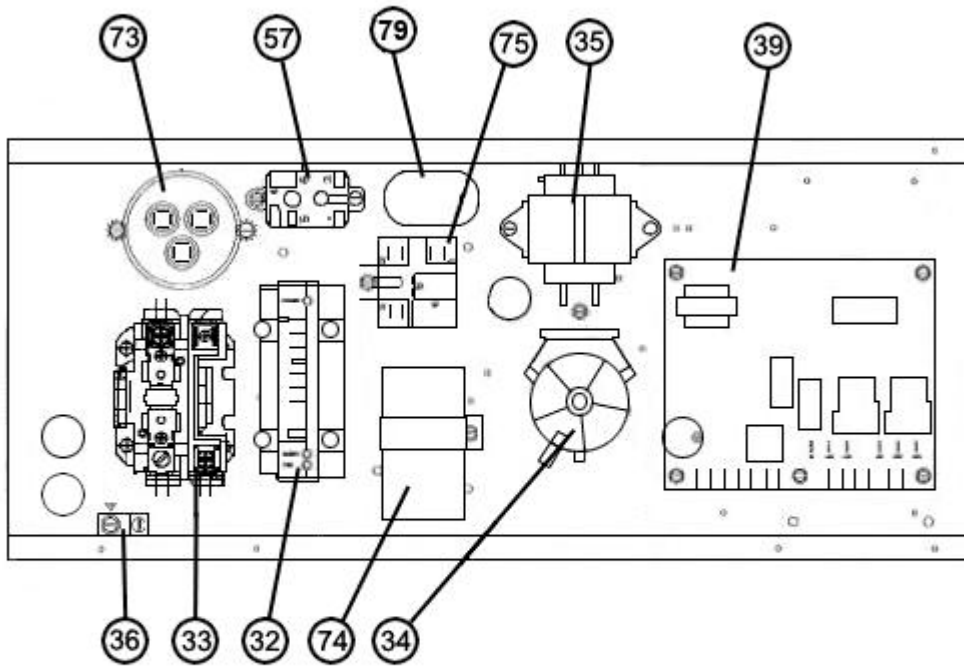

Electrical Control Box

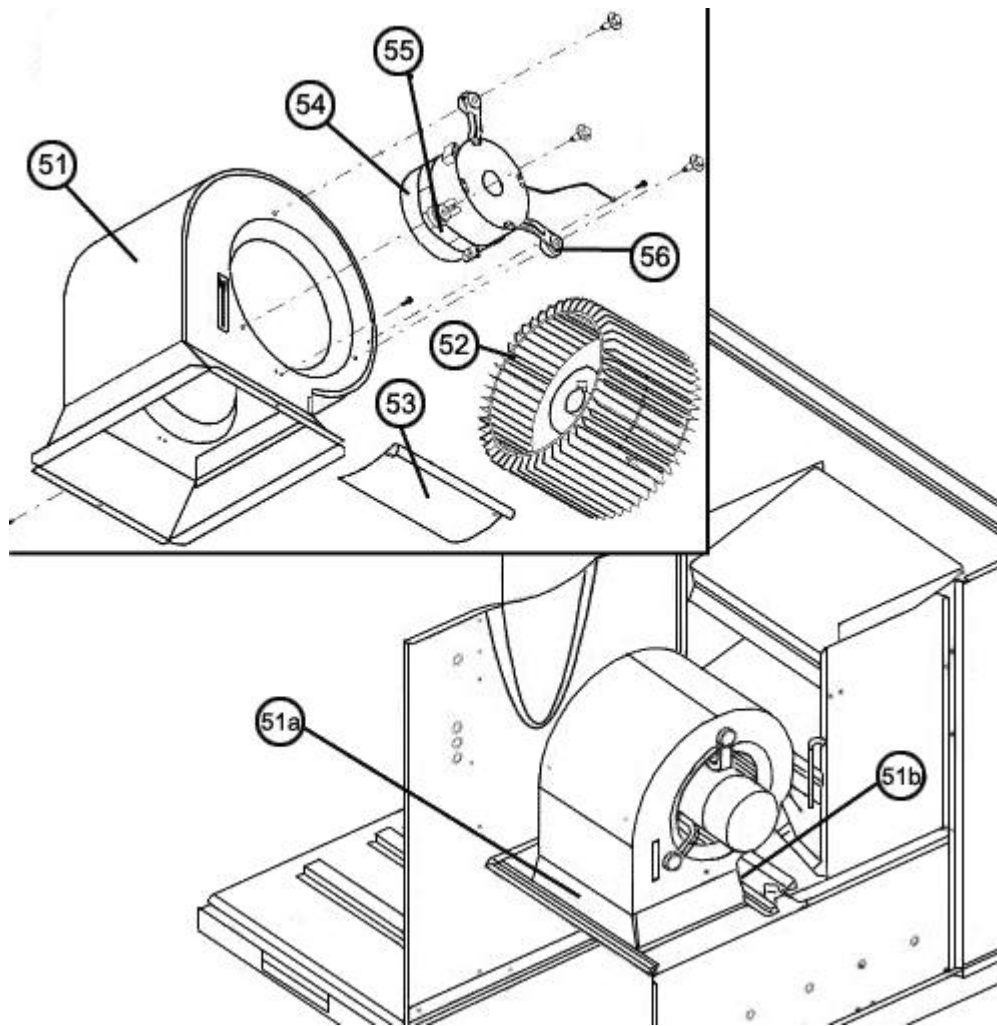

Blower Assembly

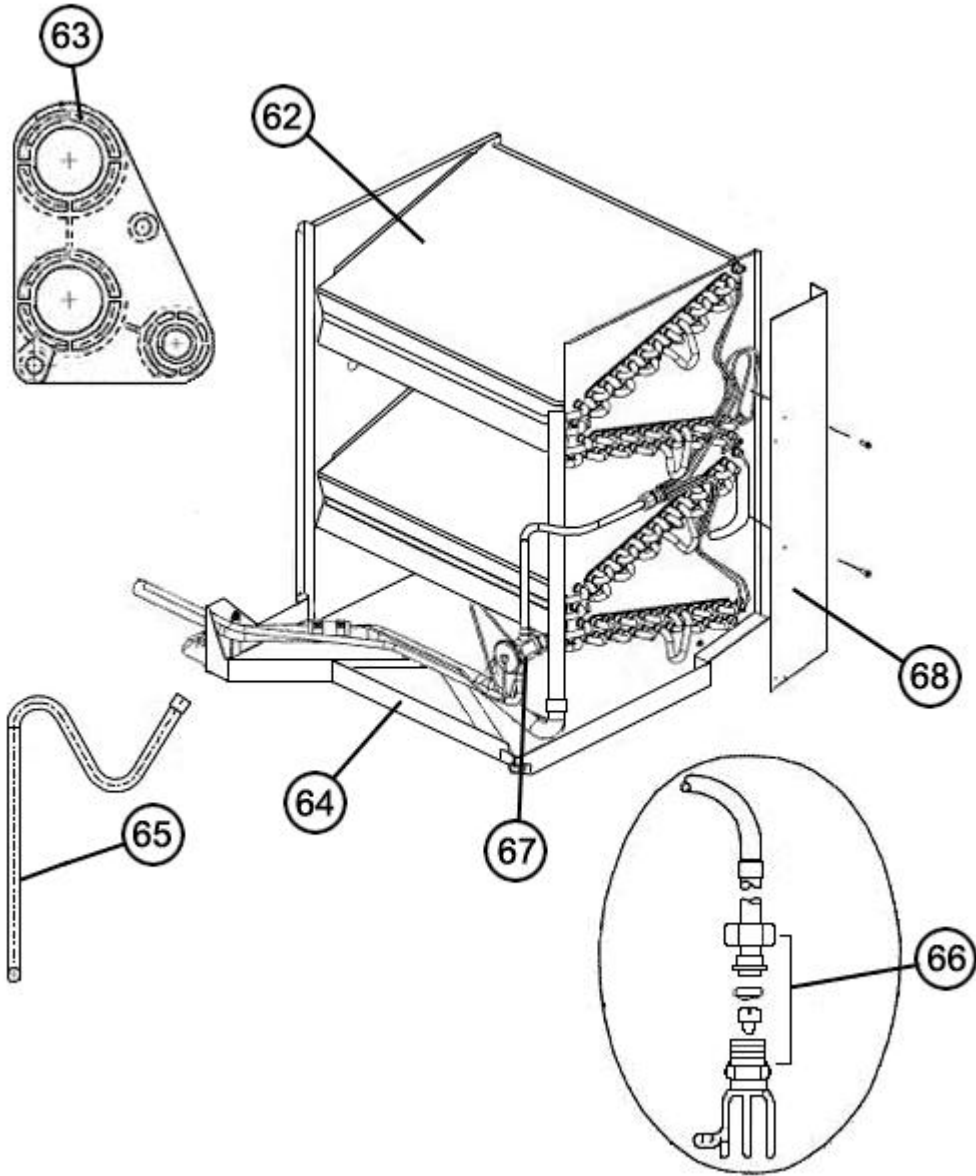

Evaporator Coil Assembly

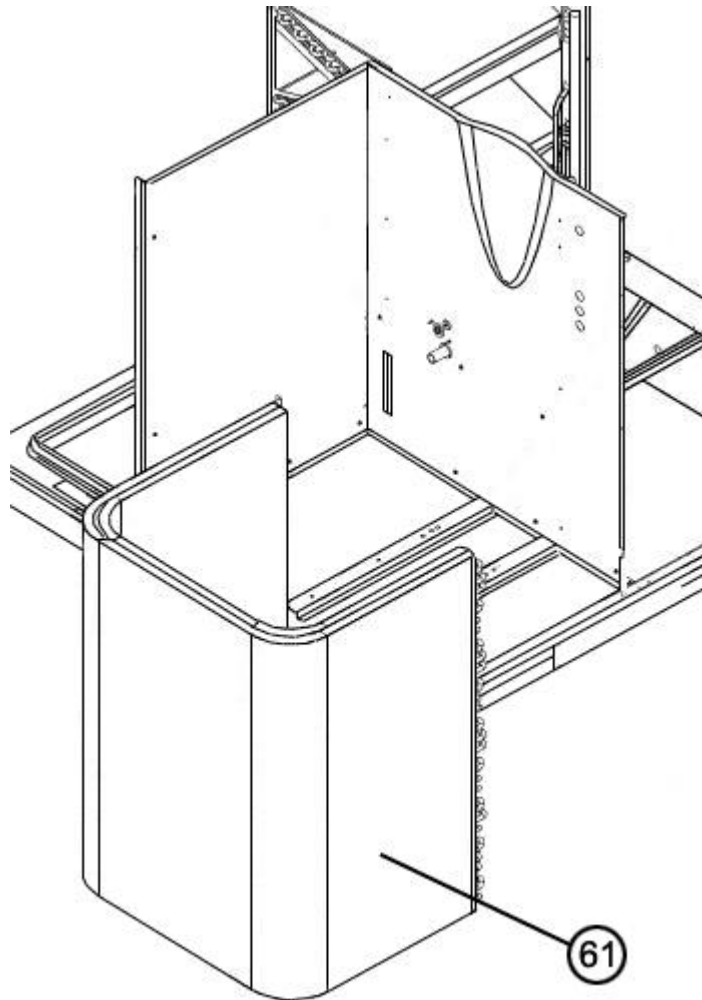

Condenser Coil

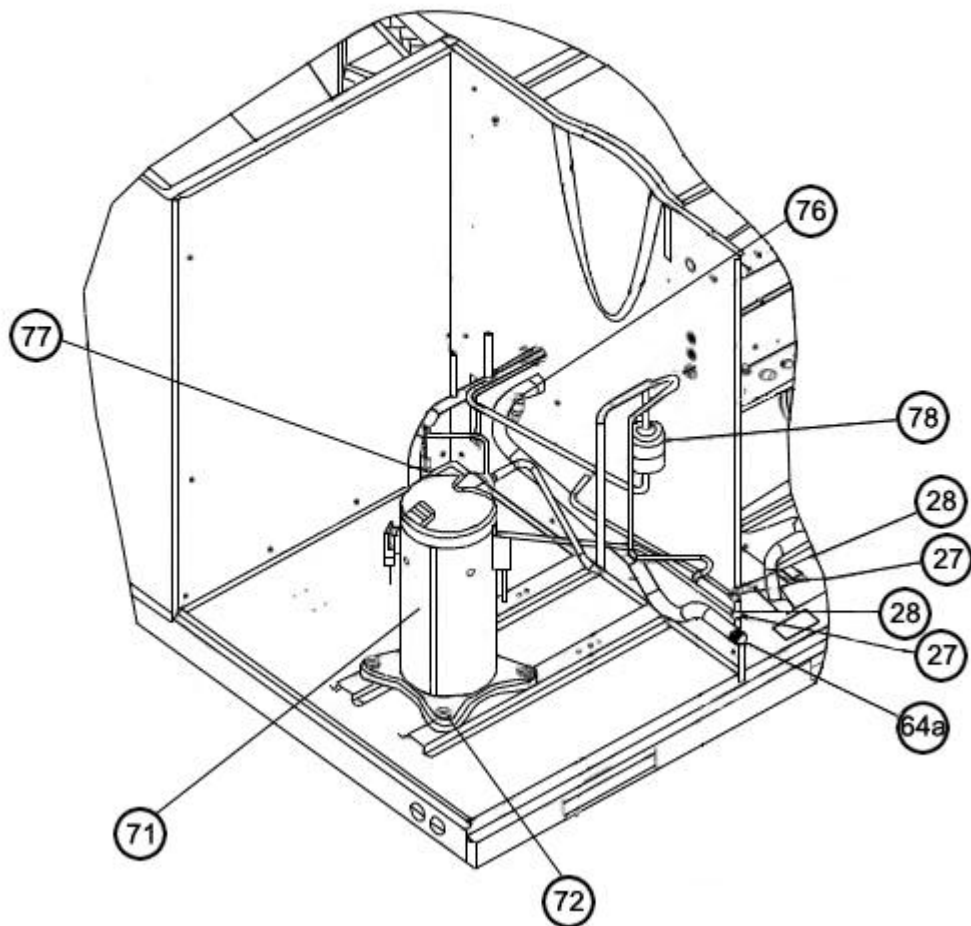

Compressor Assembly

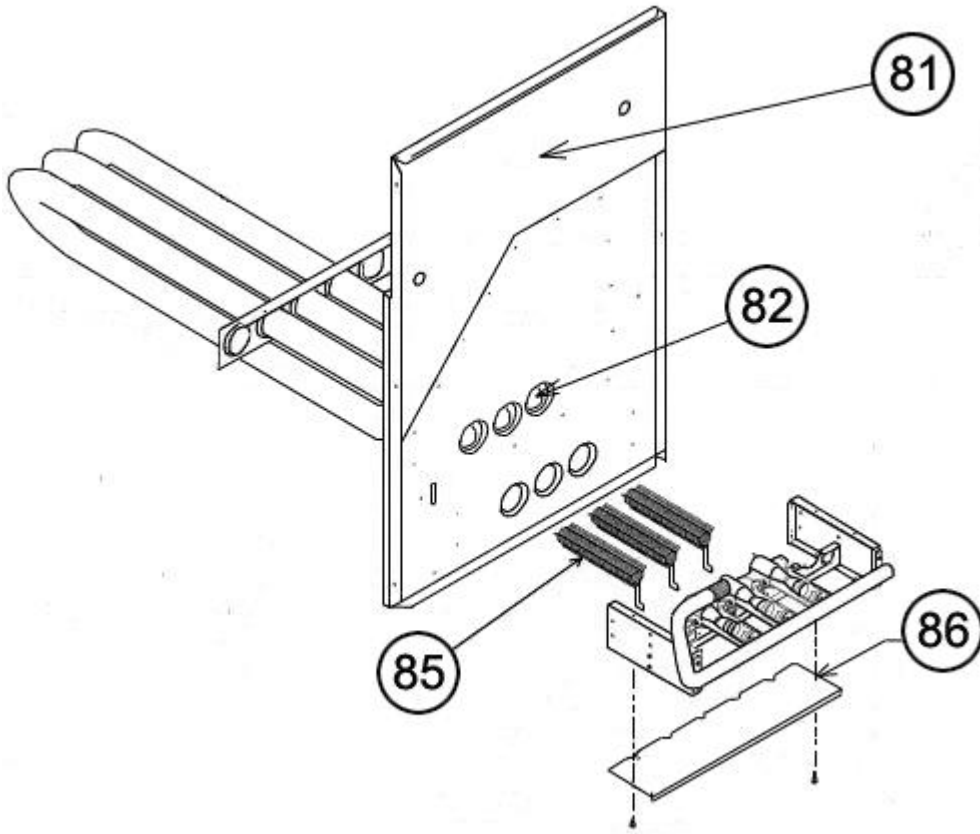

Heat Exchanger Assembly

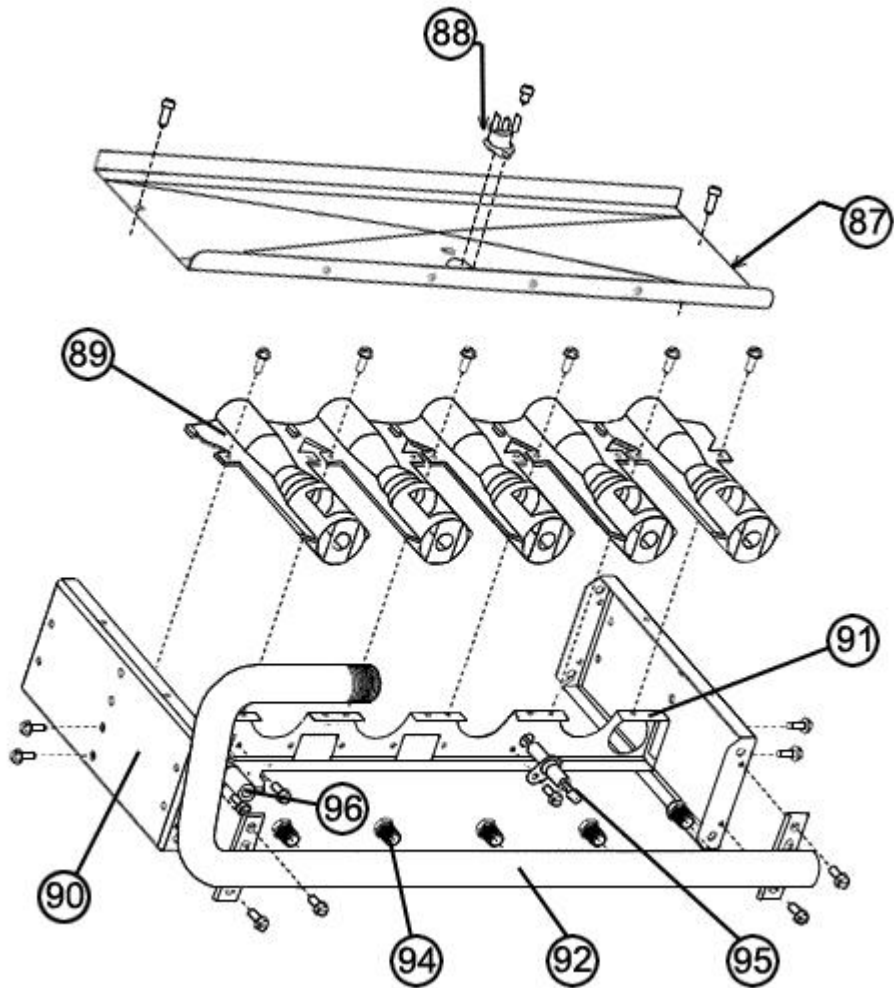

Burner Assembly

NOTES

Stk It is recommended that stock be maintained for this part.

N/A Not Applicable

- 1 Order Gas Valve for Natural Gas along with LP Conversion Kit.
- 2 This kit includes all necessary items to retrofit units using individual burner tubes with the later one-piece burner design.
- 3 Units manufactured after date code F2608 do not require resistor (44-102333-01).