

This Owner's Manual is provided and hosted by [Appliance Factory Parts](#).



COMFORT-AIRE HRG1348-3A Owner's Manual

[Shop genuine replacement parts for COMFORT-AIRE
HRG1348-3A](#)



[Find Your COMFORT-AIRE HVAC Parts - Select From 1486 Models](#)

----- Manual continues below -----

HEAT CONTROLLER, INC.

HRG13

Parts List
09-March-2012



This parts list is current as of the above revision date.

Form Number: 92-42810-HRG13

Table of Contents

Model Explanation	Page 3
Parts Numbers	
Panels - Miscellaneous	Page 4
Electrical-Fan Group	Page 5
Coil Parts	Page 6
Compressor Group	Page 7
Accessories	Page 8
Drawings/Photographs	
Exploded View	Page 9
Control Box Assembly	Page 10
Valve Mounting Detail	Page 11
Notes	Page 12

MODEL NUMBER EXPLANATION

H	R	G	1	3	1	8	-	1	A
1				2		3			

- (1) SERIES**
- (2) COOLING CAPACITY (BTU/HR)**
 18 = 18,000
 24 = 24,000
 30 = 30,000
 36 = 36,000
 42 = 42,000
 48 = 48,000
 60 = 60,000
- (3) OPTIONS**

SERIAL NUMBER EXPLANATION

7	0	9	2	N	0	7	0	1	9	9	9	9	9
1				2	3		4		5				

- (1) COMPRESSOR IDENTIFICATION NUMBER**
- (2) PRODUCTION LOCATION**
- (3) WEEK OF PRODUCTION**
- (4) YEAR OF PRODUCTION**
- (5) PRODUCTION NUMBER**

No.	Notes	MODEL COOLING CAPACITY VARIATION	HRG13 18 1A	HRG13 24 1A	HRG13 30 1A	HRG13 36 1A	HRG13 36 3A	HRG13 36 4A
SHEET METAL PARTS, MISCELLANEOUS								
1		Cabinet	AE-100726-31	AE-100726-31	AE-100726-32	AE-100726-33	AE-100726-33	AE-100726-33
2		Cabinet Panel	AE-100727-31	AE-100727-31	AE-100727-32	AE-100727-33	AE-100727-33	AE-100727-33
3		Base Pan	AS-100058-01	AS-100058-01	AS-100058-02	AE-101588-03	AE-101588-03	AE-101588-03
4		Control Box - 2 inch diameter capacitor	AE-100654-31	AE-100654-31	AE-100654-31	AE-100654-31	AE-100654-31	AE-100654-31
4		Control Box - 2-1/2 inch diameter capacitor	N/A	N/A	N/A	AE-100654-32	AE-100654-32	AE-100654-32
5		Control Box Cover	AE-100657-31	AE-100657-31	AE-100657-31	AE-100657-31	AE-100657-31	AE-100657-31
6		Top Panel - ICECO Gray	AE-100652-01	AE-100652-01	AE-100652-02	AE-100652-03	AE-100652-03	AE-100652-03
6		Top Panel - Private Label Gray	AE-100652-31	AE-100652-31	AE-100652-32	AE-100652-33	AE-100652-33	AE-100652-33
8		Grille	95-100906-01	95-100906-01	95-100906-03	95-100906-04	95-100906-04	95-100906-04
		Center Cap - Blank (for Grille)	91-101123-09	91-101123-09	91-101123-09	91-101123-09	91-101123-09	91-101123-09
12		Valve Mounting Panel	AE-57780-01	AE-57780-01	AE-57780-01	AE-57780-01	AE-57780-01	AE-57780-01
14		Service Valve - Suction	See Coil Group					
15		Service Valve - Liquid	See Coil Group					
17		Low Voltage Cover	AE-57756-01	AE-57756-01	AE-57756-01	AE-57756-01	AE-57756-01	AE-57756-01
		Touch-up Paint - ICECO Gray (Aerosol)	523009	523009	523009	523009	523009	523009
		Touch-up Paint - ICECO Gray (Paint Pens)	523011	523011	523011	523011	523011	523011
		Touch-up Paint - Private Label Gray (Aerosol)	523014	523014	523014	523014	523014	523014
		Touch-up Paint - Private Label Gray (Paint Pe	523015	523015	523015	523015	523015	523015

No.	Notes	MODEL COOLING CAPACITY VARIATION	HRG13 42 1A	HRG13 42 3A	HRG13 42 4A	HRG13 48 1A	HRG13 48 3A	HRG13 48 4A
SHEET METAL PARTS, MISCELLANEOUS								
1		Cabinet	AE-100726-34	AE-100726-34	AE-100726-34	AE-100726-34	AE-100726-34	AE-100726-34
2		Cabinet Panel	AE-100727-34	AE-100727-34	AE-100727-34	AE-100727-34	AE-100727-34	AE-100727-34
3		Base Pan	AE-101588-03	AE-101588-03	AE-101588-03	AE-101588-03	AE-101588-03	AE-101588-03
4		Control Box	AE-100654-34	AE-100654-34	AE-100654-34	AE-100654-34	AE-100654-34	AE-100654-34
5		Control Box Cover	AE-100657-31	AE-100657-31	AE-100657-31	AE-100657-31	AE-100657-31	AE-100657-31
6		Top Panel - ICECO Gray	AE-100652-03	AE-100652-03	AE-100652-03	AE-100652-03	AE-100652-03	AE-100652-03
6		Top Panel - Private Label Gray	AE-100652-33	AE-100652-33	AE-100652-33	AE-100652-33	AE-100652-33	AE-100652-33
8		Grille	95-100906-04	95-100906-04	95-100906-04	95-100906-04	95-100906-04	95-100906-04
		Center Cap - Blank (for Grille)	91-101123-09	91-101123-09	91-101123-09	91-101123-09	91-101123-09	91-101123-09
12		Valve Mounting Panel	AE-100185-31	AE-100185-31	AE-100185-31	AE-100185-31	AE-100185-31	AE-100185-31
14		Service Valve - Suction	See Coil Group					
15		Service Valve - Liquid	See Coil Group					
17		Low Voltage Cover	AE-57756-01	AE-57756-01	AE-57756-01	AE-57756-01	AE-57756-01	AE-57756-01
		Touch-up Paint - ICECO Gray (Aerosol)	523009	523009	523009	523009	523009	523009
		Touch-up Paint - ICECO Gray (Paint Pens)	523011	523011	523011	523011	523011	523011
		Touch-up Paint - Private Label Gray (Aerosol)	523014	523014	523014	523014	523014	523014
		Touch-up Paint - Private Label Gray (Paint Pe	523015	523015	523015	523015	523015	523015

No.	Notes	MODEL COOLING CAPACITY VARIATION	HRG13 48 5A	HRG13 60 1A	HRG13 60 1A	HRG13 60 1A	HRG13 60 1A	
SHEET METAL PARTS, MISCELLANEOUS								
1		Cabinet	AE-100726-34	AE-100726-34	AE-100726-34	AE-100726-34	AE-100726-34	
2		Cabinet Panel	AE-100727-34	AE-100727-34	AE-100727-34	AE-100727-34	AE-100727-34	
3		Base Pan	AE-101588-03	AE-101588-03	AE-101588-03	AE-101588-03	AE-101588-03	
4		Control Box	AE-100654-34	AE-100654-34	AE-100654-34	AE-100654-34	AE-100654-34	
5		Control Box Cover	AE-100657-31	AE-100657-31	AE-100657-31	AE-100657-31	AE-100657-31	
6		Top Panel - ICECO Gray	AE-100652-03	AE-100652-03	AE-100652-03	AE-100652-03	AE-100652-03	
6		Top Panel - Private Label Gray	AE-100652-33	AE-100652-33	AE-100652-33	AE-100652-33	AE-100652-33	
8		Grille	95-100906-04	95-100906-04	95-100906-04	95-100906-04	95-100906-04	
		Center Cap - Blank (for Grille)	91-101123-09	91-101123-09	91-101123-09	91-101123-09	91-101123-09	
12		Valve Mounting Panel	AE-100185-31	AE-100185-31	AE-100185-31	AE-100185-31	AE-100185-31	
14		Service Valve - Suction	See Coil Group					
15		Service Valve - Liquid	See Coil Group					
17		Low Voltage Cover	AE-57756-01	AE-57756-01	AE-57756-01	AE-57756-01	AE-57756-01	
		Touch-up Paint - ICECO Gray (Aerosol)	523009	523009	523009	523009	523009	
		Touch-up Paint - ICECO Gray (Paint Pens)	523011	523011	523011	523011	523011	
		Touch-up Paint - Private Label Gray (Aerosol)	523014	523014	523014	523014	523014	
		Touch-up Paint - Private Label Gray (Paint Pe	523015	523015	523015	523015	523015	

No.	Notes	MODEL COOLING CAPACITY VARIATION	HRG13 18 1A	HRG13 24 1A	HRG13 30 1A	HRG13 36 1A	HRG13 36 3A	HRG13 36 4A
ELECTRICAL/FAN GROUP								
7	Stk	Fan Motor	51-101774-04	51-101774-04	51-101774-02	51-102008-07	51-102008-07	51-101774-05
9	Stk	Fan Blade	70-102033-05	70-102033-05	70-102033-02	70-102011-04	70-102011-10	70-102011-10
16	Stk	Contactora	42-42478-03	42-42478-03	42-42478-03	42-42478-03	42-102664-08	42-102664-08
17		Low Voltage Cover	See Panels - Miscellaneous					
18		Control Box Bottom	AE-100655-01	AE-100655-01	AE-100655-01	AE-100655-01	AE-100655-01	AE-100655-01
19		Capacitor - Compressor/Fan	See Compressor Group					
20	Stk	Defrost Control Board (Before Date Code1209)	47-21517-16	47-21517-16	47-21517-16	47-21517-16	47-102684-01	47-102684-01
20	Stk	Defrost Control Board (After Date Code1209)	47-102684-01	47-102684-01	47-102684-01	47-102684-01	47-102684-01	47-102684-01
21		Low Ambient Control	See Accessories Group					

No.	Notes	MODEL COOLING CAPACITY VARIATION	HRG13 42 1A	HRG13 42 3A	HRG13 42 4A	HRG13 48 1A	HRG13 48 3A	HRG13 48 4A
ELECTRICAL/FAN GROUP								
7	Stk	Fan Motor	51-102008-07	51-102008-07	51-101774-05	51-102008-07	51-102008-07	51-101774-05
9	Stk	Fan Blade	70-102011-04	70-102011-10	70-102011-10	70-102011-04	70-102011-10	70-102011-10
16	Stk	Contactora	42-42478-03	42-102664-08	42-102664-08	42-42478-03	42-102664-08	42-102664-08
17		Low Voltage Cover	See Panels - Miscellaneous					
18		Control Box Bottom	AE-100655-01	AE-100655-01	AE-100655-01	AE-100655-01	AE-100655-01	AE-100655-01
19		Capacitor - Compressor/Fan	See Compressor Group					
20	Stk	Defrost Control Board (Before Date Code1209)	47-21517-16	47-102684-01	47-102684-01	47-21517-16	47-102684-01	47-102684-01
20	Stk	Defrost Control Board (After Date Code1209)	47-102684-01	47-102684-01	47-102684-01	47-102684-01	47-102684-01	47-102684-01
21		Low Ambient Control	See Accessories Group					

No.	Notes	MODEL COOLING CAPACITY VARIATION	HRG13 48 5A	HRG13 60 1A	HRG13 60 1A	HRG13 60 1A	HRG13 60 1A	
ELECTRICAL/FAN GROUP								
7	Stk	Fan Motor	51-101774-10	51-102008-07	51-102008-07	51-101774-05	51-101774-10	
9	Stk	Fan Blade	70-102011-10	70-102011-04	70-102011-10	70-102011-10	70-102011-10	
16	Stk	Contactora	42-102664-08	42-42478-02	42-102664-14	42-102664-14	42-102664-14	
17		Low Voltage Cover	See Panels - Miscellaneous					
18		Control Box Bottom	AE-100655-01	AE-100655-01	AE-100655-01	AE-100655-01	AE-100655-01	
19		Capacitor - Compressor/Fan	See Compressor Group					
20	Stk	Defrost Control Board (Before Date Code1209)	47-102684-01	47-21517-16	47-102684-01	47-102684-01	47-102684-01	
20	Stk	Defrost Control Board (After Date Code1209)	47-102684-01	47-102684-01	47-102684-01	47-102684-01	47-102684-01	
21		Low Ambient Control	See Accessories Group					

No.	Notes	MODEL COOLING CAPACITY VARIATION	HRG13	HRG13	HRG13	HRG13	HRG13	HRG13
			18 1A	24 1A	30 1A	36 1A	36 3A	36 4A
COIL GROUP								
11	Stk	Condenser Coil	AS-101766-03	AS-101766-03	AS-102391-03	AS-101768-03	AS-101768-03	AS-101768-03
13		Valve Mounting Bracket	AE-57781-01	AE-57781-01	AE-57781-01	AE-57781-02	AE-57781-02	AE-57781-02
14		Service Valve - Suction	61-21368-23	61-21368-23	61-21368-07	61-21368-22	61-21368-22	61-21368-22
15		Service Valve - Liquid	61-21368-05	61-21368-05	61-21368-05	61-21368-05	61-21368-05	61-21368-05
22		Bulkhead Valve	61-22369-04	61-22369-04	61-22369-04	61-22369-04	61-22369-04	61-22369-04
		Locknut - Bulkhead Valve	63-22368-01	63-22368-01	63-22368-01	63-22368-01	63-22368-01	63-22368-01
	Stk,3	Low Pressure Control (After Date Code1209) - See Note 3	47-102240-04	47-102240-04	47-102240-04	47-102240-04	N/A	N/A
	Stk	Filter Drier	83-41719-04	83-41719-04	83-41719-04	83-41719-04	83-41719-04	83-41719-04
	Stk	TXV/Distributor Assembly	61-102437-01	61-102437-02	61-102437-03	61-102437-03	61-102437-03	61-102437-03
	Stk	Reversing Valve	61-102498-04	61-102498-04	61-101684-02	61-101684-02	61-101684-02	61-101684-02
		Solenoid Coil - Reversing Valve (Before Date Code 2808)	61-101713-92	61-101713-01	61-101713-01	61-101713-01	61-101713-01	61-101713-01
	Stk	Solenoid Coil - Reversing Valve (After Date Code 2808)	61-101713-92	61-101713-92	61-101713-92	61-101713-92	61-101713-92	61-101713-92
		Wiring Harness - Reversing Valve	61-26149-03	61-26149-03	61-26149-03	61-26149-03	61-26149-03	61-26149-03

No.	Notes	MODEL COOLING CAPACITY VARIATION	HRG13	HRG13	HRG13	HRG13	HRG13	HRG13
			42 1A	42 3A	42 4A	48 1A	48 3A	48 4A
COIL GROUP								
11	Stk	Condenser Coil	AS-101760-03	AS-101760-03	AS-101760-03	AS-102099-03	AS-102099-03	AS-102099-03
13		Valve Mounting Bracket	AE-57781-02	AE-57781-02	AE-57781-02	AE-57781-02	AE-57781-02	AE-57781-02
14		Service Valve - Suction	61-21368-22	61-21368-22	61-21368-22	61-21368-08	61-21368-08	61-21368-08
15		Service Valve - Liquid	61-21368-05	61-21368-05	61-21368-05	61-21368-05	61-21368-05	61-21368-05
22		Bulkhead Valve	61-22369-04	61-22369-04	61-22369-04	61-22369-04	61-22369-04	61-22369-04
		Locknut - Bulkhead Valve	63-22368-01	63-22368-01	63-22368-01	63-22368-01	63-22368-01	63-22368-01
	Stk,3	Low Pressure Control (After Date Code1209) - See Note 3	47-102240-04	N/A	N/A	47-102240-04	N/A	N/A
	Stk	Filter Drier	83-41719-04	83-41719-04	83-41719-04	83-41719-04	83-41719-04	83-41719-04
	Stk	TXV/Distributor Assembly	61-102437-05	61-102437-05	61-102437-05	61-102437-06	61-102437-06	61-102437-06
	Stk,2	Reversing Valve - See Note 2	61-101684-02	61-101684-02	61-101684-02	61-101684-06	61-101684-06	61-101684-06
		Solenoid Coil - Reversing Valve (Before Date Code 2808)	61-101713-01	61-101713-01	61-101713-01	61-101713-01	61-101713-01	61-101713-01
	Stk	Solenoid Coil - Reversing Valve (After Date Code 2808)	61-101713-92	61-101713-92	61-101713-92	61-101713-92	61-101713-92	61-101713-92
		Wiring Harness - Reversing Valve	61-26149-03	61-26149-03	61-26149-03	61-26149-03	61-26149-03	61-26149-03

No.	Notes	MODEL COOLING CAPACITY VARIATION	HRG13	HRG13	HRG13	HRG13	HRG13	
			48 5A	60 1A	60 1A	60 1A	60 1A	
COIL GROUP								
11	Stk	Condenser Coil	AS-102099-03	AS-102099-03	AS-102099-03	AS-102099-03	AS-102099-03	
13		Valve Mounting Bracket	AE-57781-02	AE-57781-02	AE-57781-02	AE-57781-02	AE-57781-02	
14		Service Valve - Suction	61-21368-08	61-21368-08	61-21368-08	61-21368-08	61-21368-08	
15		Service Valve - Liquid	61-21368-05	61-21368-05	61-21368-05	61-21368-05	61-21368-05	
22		Bulkhead Valve	61-22369-04	61-22369-04	61-22369-04	61-22369-04	61-22369-04	
		Locknut - Bulkhead Valve	63-22368-01	63-22368-01	63-22368-01	63-22368-01	63-22368-01	
		Charge Compensator	N/A	83-25361-09	83-25361-09	83-25361-09	83-25361-09	
	Stk,3	Low Pressure Control (After Date Code1209) - See Note 3	N/A	47-102240-04	N/A	N/A	N/A	
	Stk	Filter Drier	83-41719-04	83-41719-04	83-41719-04	83-41719-04	83-41719-04	
	Stk	TXV/Distributor Assembly	61-102437-06	61-102437-07	61-102437-07	61-102437-07	61-102437-07	
	Stk,2	Reversing Valve - See Note 2	61-101684-06	61-102498-06	61-102498-06	61-102498-06	61-102498-06	
		Solenoid Coil - Reversing Valve (Before Date Code 2808)	61-101713-01	61-101713-01	61-101713-01	61-101713-01	61-101713-01	
	Stk	Solenoid Coil - Reversing Valve (After Date Code 2808)	61-101713-92	61-101713-92	61-101713-92	61-101713-92	61-101713-92	
		Wiring Harness - Reversing Valve	61-26149-03	61-26149-03	61-26149-03	61-26149-03	61-26149-03	

No.	Notes	MODEL COOLING CAPACITY VARIATION	HRG13 18 1A	HRG13 24 1A	HRG13 30 1A	HRG13 36 1A	HRG13 36 3A	HRG13 36 4A
COMPRESSOR GROUP								
		Compressor ID:	7687	7688	7689	7690	8000	8001
10	Stk	Compressor	55-102045-14S	55-102045-01S	55-102045-02S	55-102045-03S	55-102045-05S	55-102045-04S
19	Stk	Capacitor - Compressor/Fan (2 inch diameter)	43-26261-40	43-26261-09	43-26261-09	43-26261-48	43-101666-60	43-101666-59
	Stk	Capacitor - Compressor/Fan (2-1/2 inch diameter)	N/A	N/A	N/A	43-101665-48	N/A	N/A
	Stk	Compressor Wiring Harness (Molded Plug)	45-100834-80	45-100834-80	45-100834-80	45-100834-80	45-100834-80	45-100834-80
		Muffler	83-26251-01	83-26251-01	83-26251-01	83-26251-01	83-26251-01	83-26251-01
		Compressor ID:	7837		7714	7705		
10	1	Original Compressor - See Note 1	55-101545-43S		55-101545-30S	55-102282-07S		
10	Stk,1	Replacement Compressor (Retrofit Kit Required) - See Note 1	55-102045-14S		55-102045-02S	55-102045-03S		
	Stk,1	Retrofit Kit - See Note 1	831018		831019	831020		
19	Stk	Capacitor - Compressor/Fan (Original Compressor)	43-26261-40		43-26261-44	43-26261-48		
		Muffler/Check Valve (Original Compressor)	83-101828-01		83-101828-01	N/A		
		Muffler (Original Compressor)	N/A			83-26251-01		
		Compressor ID:			7838			
10	1	Original Compressor - See Note 1			55-101545-44S			
	Stk,1	Replacement Compressor (Retrofit Kit Required) - See Note 1			55-102045-02S			
	Stk,1	Retrofit Kit - See Note 1			831019			
19	Stk	Capacitor - Compressor/Fan (Original Compressor)			43-26261-44			
		Muffler/Check Valve (Original Compressor)			83-101828-01			
		Muffler (Original Compressor)			N/A			

No.	Notes	MODEL COOLING CAPACITY VARIATION	HRG13 42 1A	HRG13 42 3A	HRG13 42 4A	HRG13 48 1A	HRG13 48 3A	HRG13 48 4A
COMPRESSOR GROUP								
		Compressor ID:	7691	8002	8003	7692	8004	8005
10	Stk	Compressor	55-102045-12S	55-102045-16S	55-102045-25S	55-102045-09S	55-102045-11S	55-102045-10S
19	Stk	Capacitor - Compressor/Fan	43-26261-42	43-101666-60	43-101666-59	43-26261-47	43-101666-60	43-101666-59
	Stk	Compressor Wiring Harness (Molded Plug)	45-100834-80	45-100834-80	45-100834-80	45-100834-80	45-100834-80	45-100834-80
		Muffler	83-26251-01	83-26251-01	83-26251-01	83-26251-01	83-26251-01	83-26251-01
		Compressor ID:	7706					
10	1	Original Compressor - See Note 1	55-102282-05S					
	Stk,1	Replacement Compressor (Retrofit Kit Required) - See Note 1	55-102045-12S					
	Stk,1	Retrofit Kit - See Note 1	831021					
19	Stk	Capacitor - Compressor/Fan (Original Compressor)	43-26261-38					
		Muffler (Original Compressor)	83-26251-01					

No.	Notes	MODEL COOLING CAPACITY VARIATION	HRG13 48 5A	HRG13 60 1A	HRG13 60 1A	HRG13 60 1A	HRG13 60 1A
COMPRESSOR GROUP							
		Compressor ID:	8006	7693	8007	8008	8009
10	Stk	Compressor	55-102045-29S	55-102045-13S	55-102045-22S	55-102045-23S	55-102045-30S
19	Stk	Capacitor - Compressor/Fan	43-101666-59	43-101665-30	43-101666-60	43-101666-59	43-101666-59
	Stk	Compressor Wiring Harness (Molded Plug)	45-100834-80	45-100834-80	45-100834-80	45-100834-80	45-100834-80
		Muffler	83-26251-01	83-26251-01	83-26251-01	83-26251-01	83-26251-01
		Crankcase Heater	N/A	44-101884-05	44-103663-01	44-101884-09	44-101884-07

No.	Notes	MODEL COOLING CAPACITY VARIATION	HRG13 ALL ALL
ACCESSORIES			
		Low Ambient Control	RXAD-A08
		Outdoor Thermostat (One Thermostat w/box)	RXPT-A01
		Outdoor Thermostat (One Thermostat w/o box)	RXPT-A02
		Outdoor Thermostat (One w/Heat Relay and box)	RXPT-A03
		Outdoor Thermostat (Two Thermostats w/Heat and box)	RXPT-A04
		Heat Pump Monitor	RXPM-B01
		Compressor Time Delay Control	RXMD-B01
		Blower Time Delay Control	RXMD-C04
		High Pressure Control	RXAB-A07



Exploded View

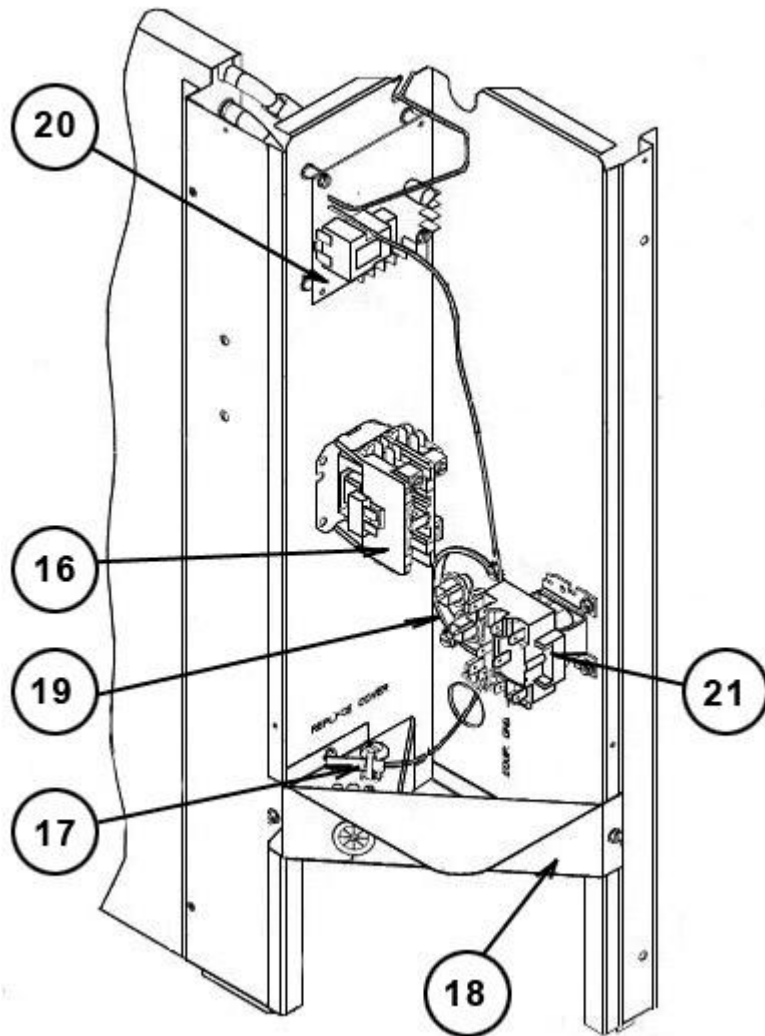

Control Box Assembly

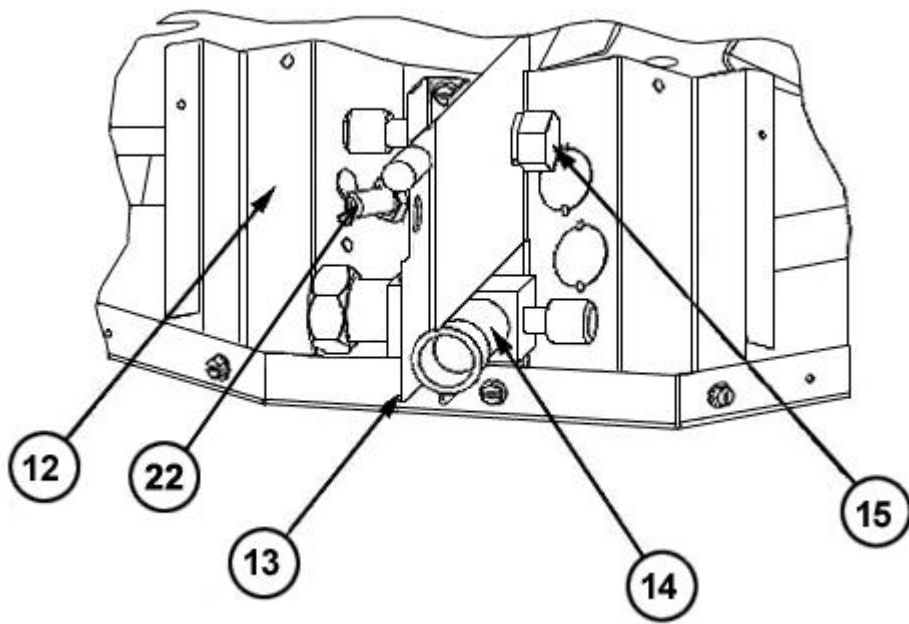

Valve Mounting Detail

NOTES

Stk It is recommended that stock be maintained for this part.

N/A Not Applicable

- 1 This compressor should be replaced with the designated Copleland scroll (55-102045 series) and the specified Retrofit Kit. **USE OF THE RETROFIT KIT IS REQUIRED WHEN PERFORMING THIS REPLACEMENT.** Failure to use the kit will greatly increase the likelihood of future compressor failure and will void the compressor warranty.
- 2 The reversing valve specified for 048 and 060 models may be different than the one originally supplied with the equipment. The use of the specified valve is recommended for improved shifting performance.
- 3 This low pressure switch should only be used with units manufactured after the effective date shown. It is not compatible with the Defrost Control Board used on units manufactured before this date.