

This Owner's Manual is provided and hosted by [Appliance Factory Parts](#).



COMFORT-AIRE RSE1360-3A Owner's Manual

[Shop genuine replacement parts for COMFORT-AIRE
RSE1360-3A](#)



[Find Your COMFORT-AIRE HVAC Parts - Select From 1486 Models](#)

----- Manual continues below -----

HEAT CONTROLLER, INC.

RSE13

Parts List
08-March-2012



This parts list is current as of the above revision date.

Form Number: 92-42810-RSE13

Table of Contents

Model Explanation	Page 3
Parts Numbers	
Panels - Miscellaneous (Single Phase)	Page 4
Panels - Miscellaneous (Three Phase).....	Page 5
Electrical-Fan Group	Page 6
Coil Parts	Page 7
Compressor Group (Single Phase)	Page 8
Compressor Group (Three Phase).....	Page 9
Accessories	Page 10
Drawings/Photographs	
Exploded View	Page 11
Valve Mounting Assembly	Page 12
Control Box	Page 13
Notes	Page 14

MODEL NUMBER EXPLANATION

R	S	E	1	3	1	8	-	1	A
1				2		3			

- (1) **SERIES**
- (2) **COOLING CAPACITY (BTU/HR)**
 - 18= 18,000
 - 24= 24,000
 - 30= 30,000
 - 36= 36,000
 - 42= 42,000
 - 48= 48,000
 - 60= 60,000
- (3) **OPTIONS**

SERIAL NUMBER EXPLANATION

7	0	9	2	M	0	7	0	1	9	9	9	9	9
1				2	3		4		5				

- (1) **COMPRESSOR IDENTIFICATION NUMBER**
- (2) **PRODUCTION LOCATION**
- (3) **WEEK OF PRODUCTION**
- (4) **YEAR OF PRODUCTION**
- (5) **PRODUCTION NUMBER**

No.	Notes	MODEL COOLING CAPACITY VARIATION	RSE13 18 1A/1N	RSE13 24 1A/1N	RSE13 30 1A/1N	RSE13 36 1A/1N
SHEET METAL PARTS, MISCELLANEOUS						
1		Cabinet	AE-100726-31	AE-100726-31	AE-100726-32	AE-100726-33
2		Cabinet Panel	AE-100727-35	AE-100727-31	AE-100727-32	AE-100727-33
5		Base Pan - Before Date Code 1207	AE-100069-01	AE-100069-01	AE-100069-02	AS-100058-03
5		Base Pan - After Date Code 1207	AE-100069-01	AE-100069-01	AE-100069-02	AE-101588-03
6		Control Box (2 inch O.D. Capacitor)	AE-100654-31	AE-100654-31	AE-100654-31	AE-100654-31
6		Control Box (2-1/2 inch O.D. Capacitor)	N/A	N/A	N/A	AE-100654-32
7		Control Box Cover	AE-100657-31	AE-100657-31	AE-100657-31	AE-100657-31
8		Top Panel - Before Date Code 1207 (Private Label Gray)	N/A	N/A	N/A	AE-100652-04
8		Top Panel - After Date Code 1207 (ICECO Gray)	N/A	N/A	N/A	AE-100652-03
8		Top Panel - After Date Code 1207 (Private Label Gray)	N/A	N/A	N/A	AE-100652-33
8		Top Panel - ICECO Gray	AE-100652-01	AE-100652-01	AE-100652-02	N/A
8		Top Panel - Private Label Gray	AE-100652-31	AE-100652-31	AE-100652-32	N/A
10		Grille - Before Date Code 1207	95-100906-01	95-100906-01	95-100906-03	95-100905-02
10		Grille - After Date Code 1207	95-100906-01	95-100906-01	95-100906-03	95-100906-04
		Center Cap - Blank (for Grille)	91-101123-09	91-101123-09	91-101123-09	91-101123-09
14		Valve Mounting Panel	AE-57780-01	AE-57780-01	AE-57780-01	AE-57780-01
16		Service Valve - Suction	See Coil Group			
17		Service Valve - Liquid	See Coil Group			
19		Low Voltage Cover	AE-57756-01	AE-57756-01	AE-57756-01	AE-57756-01
		Touch-up Paint - ICECO Gray (Aerosol)	523009	523009	523009	523009
		Touch-up Paint - ICECO Gray (Paint Pens)	523011	523011	523011	523011
		Touch-up Paint - Private Label Gray (Aerosol)	523014	523014	523014	523014
		Touch-up Paint - Private Label Gray (Paint Pens)	523015	523015	523015	523015

No.	Notes	MODEL COOLING CAPACITY VARIATION	RSE13 42 1A/1N	RSE13 48 1A/1N	RSE13 60 1A/1N	
SHEET METAL PARTS, MISCELLANEOUS						
1		Cabinet	AE-100726-33	AE-100726-33	AE-100726-34	
2		Cabinet Panel	AE-100727-33	AE-100727-33	AE-100727-34	
5		Base Pan - Before Date Code 1207	AS-100058-03	AS-100058-03	AS-100058-03	
5		Base Pan - After Date Code 1207	AE-101588-03	AE-101588-03	AE-101588-03	
6		Control Box (2-1/2 inch O.D. Capacitor)	AE-100654-32	AE-100654-32	AE-100654-34	
7		Control Box Cover	AE-100657-31	AE-100657-31	AE-100657-31	
8		Top Panel - Before Date Code 1207 (Private Label Gray)	AE-100652-04	AE-100652-04	AE-100652-04	
8		Top Panel - After Date Code 1207 (ICECO Gray)	AE-100652-03	AE-100652-03	AE-100652-03	
8		Top Panel - After Date Code 1207 (Private Label Gray)	AE-100652-33	AE-100652-33	AE-100652-33	
10		Grille - Before Date Code 1207	95-100905-02	95-100905-02	95-100905-02	
10		Grille - After Date Code 1207	95-100906-04	95-100906-04	95-100906-04	
		Center Cap - Blank (for Grille)	91-101123-09	91-101123-09	91-101123-09	
14		Valve Mounting Panel	AE-57780-01	AE-57780-01	AE-100185-31	
16		Service Valve - Suction	See Coil Group			
17		Service Valve - Liquid	See Coil Group			
19		Low Voltage Cover	AE-57756-01	AE-57756-01	AE-57756-01	
		Touch-up Paint - ICECO Gray (Aerosol)	523009	523009	523009	
		Touch-up Paint - ICECO Gray (Paint Pens)	523011	523011	523011	
		Touch-up Paint - Private Label Gray (Aerosol)	523014	523014	523014	
		Touch-up Paint - Private Label Gray (Paint Pens)	523015	523015	523015	

No.	Notes	MODEL COOLING CAPACITY VARIATION	RSE13	RSE13	RSE13	RSE13
			36 3A/3N	42 3A/3N	48 3A/3N	60 3A/3N
SHEET METAL PARTS, MISCELLANEOUS						
1		Cabinet	AE-100726-33	AE-100726-33	AE-100726-33	AE-100726-34
2		Cabinet Panel	AE-100727-33	AE-100727-33	AE-100727-33	AE-100727-34
5		Base Pan	AE-101588-03	AE-101588-03	AE-101588-03	AE-101588-03
6		Control Box (2 inch O.D. Capacitor)	AE-100654-31	AE-100654-31	AE-100654-31	AE-100654-33
7		Control Box Cover	AE-100657-31	AE-100657-31	AE-100657-31	AE-100657-31
8		Top Panel - ICECO Gray	AE-100652-03	AE-100652-03	AE-100652-03	AE-100652-03
8		Top Panel - Private Label Gray	AE-100652-33	AE-100652-33	AE-100652-33	AE-100652-33
10		Grille	95-100906-04	95-100906-04	95-100906-04	95-100906-04
14		Valve Mounting Panel	AE-57780-01	AE-57780-01	AE-57780-01	AE-100185-31
16		Service Valve - Suction	See Coil Group			
17		Service Valve - Liquid	See Coil Group			
19		Low Voltage Cover	AE-57756-01	AE-57756-01	AE-57756-01	AE-57756-01
		Touch-up Paint - ICECO Gray (Aerosol)	523009	523009	523009	523009
		Touch-up Paint - ICECO Gray (Paint Pens)	523011	523011	523011	523011
		Touch-up Paint - Private Label Gray (Aerosol)	523014	523014	523014	523014
		Touch-up Paint - Private Label Gray (Paint Pens)	523015	523015	523015	523015

No.	Notes	MODEL COOLING CAPACITY VARIATION	RSE13	RSE13	RSE13	RSE13
			36 4A/4N	42 4A/4N	48 4A/4N	60 4A/4N
SHEET METAL PARTS, MISCELLANEOUS						
1		Cabinet	AE-100726-33	AE-100726-33	AE-100726-33	AE-100726-34
2		Cabinet Panel	AE-100727-33	AE-100727-33	AE-100727-33	AE-100727-34
5		Base Pan	AE-101588-03	AE-101588-03	AE-101588-03	AE-101588-03
6		Control Box (2 inch O.D. Capacitor)	AE-100654-31	AE-100654-31	AE-100654-31	AE-100654-33
7		Control Box Cover	AE-100657-31	AE-100657-31	AE-100657-31	AE-100657-31
8		Top Panel - ICECO Gray	AE-100652-03	AE-100652-03	AE-100652-03	AE-100652-03
8		Top Panel - Private Label Gray	AE-100652-33	AE-100652-33	AE-100652-33	AE-100652-33
10		Grille	95-100906-04	95-100906-04	95-100906-04	95-100906-04
		Center Cap - Blank (for Grille)	91-101123-09	91-101123-09	91-101123-09	91-101123-09
14		Valve Mounting Panel	AE-57780-01	AE-57780-01	AE-57780-01	AE-100185-31
16		Service Valve - Suction	See Coil Group			
17		Service Valve - Liquid	See Coil Group			
19		Low Voltage Cover	AE-57756-01	AE-57756-01	AE-57756-01	AE-57756-01
		Touch-up Paint - ICECO Gray (Aerosol)	523009	523009	523009	523009
		Touch-up Paint - ICECO Gray (Paint Pens)	523011	523011	523011	523011
		Touch-up Paint - Private Label Gray (Aerosol)	523014	523014	523014	523014
		Touch-up Paint - Private Label Gray (Paint Pens)	523015	523015	523015	523015

No.	Notes	MODEL COOLING CAPACITY VARIATION	RSE13	RSE13		
			48 5A	60 5A		
SHEET METAL PARTS, MISCELLANEOUS						
1		Cabinet	AE-100726-33	AE-100726-34		
2		Cabinet Panel	AE-100727-33	AE-100727-34		
5		Base Pan	AE-101588-03	AE-101588-03		
6		Control Box (2 inch O.D. Capacitor)	AE-100654-31	AE-100654-33		
7		Control Box Cover	AE-100657-31	AE-100657-31		
8		Top Panel - ICECO Gray	AE-100652-03	AE-100652-03		
8		Top Panel - Private Label Gray	AE-100652-33	AE-100652-33		
10		Grille	95-100906-04	95-100906-04		
		Center Cap - Blank (for Grille)	91-101123-09	91-101123-09		
14		Valve Mounting Panel	AE-57780-01	AE-100185-31		
16		Service Valve - Suction	See Coil Group			
17		Service Valve - Liquid	See Coil Group			
19		Low Voltage Cover	AE-57756-01	AE-57756-01		
		Touch-up Paint - ICECO Gray (Aerosol)	523009	523009		
		Touch-up Paint - ICECO Gray (Paint Pens)	523011	523011		
		Touch-up Paint - Private Label Gray (Aerosol)	523014	523014		
		Touch-up Paint - Private Label Gray (Paint Pens)	523015	523015		

No.	Notes	MODEL COOLING CAPACITY VARIATION	RSE13	RSE13	RSE13	RSE13
			18 1A/1N	24 1A/1N	30 1A/1N	36 1A/1N
ELECTRICAL/FAN GROUP						
9	Stk	Fan Motor	51-102008-01	51-101774-04	51-101774-02	51-101774-02
11	Stk,1	Fan Blade - See Note 1	70-102011-01	70-102011-05	70-100580-02	70-100580-03
11	1	Fan Blade - See Note 1	N/A	N/A	N/A	70-102011-03
18	Stk	Contactora	42-42139-05	42-42139-05	42-42139-05	42-42139-05
19		Low Voltage Cover	See Panels - Miscellaneous			
20		Control Box Bottom	AE-100655-01	AE-100655-01	AE-100655-01	AE-100655-01
21		Capacitor - Compressor/Fan	See Compressor Group			

No.	Notes	MODEL COOLING CAPACITY VARIATION	RSE13	RSE13	RSE13	
			42 1A/1N	48 1A/1N	60 1A/1N	
ELECTRICAL/FAN GROUP						
9	Stk	Fan Motor	51-101774-02	51-102008-03	51-102008-03	
11	Stk,1	Fan Blade - See Note 1	70-100580-03	70-100580-04	70-100580-04	
11	1	Fan Blade - See Note 1	70-102011-03	70-102011-04	70-102011-04	
18	Stk	Contactora	42-42139-05	42-42139-05	42-42478-02	
19		Low Voltage Cover	See Panels - Miscellaneous			
20		Control Box Bottom	AE-100655-01	AE-100655-01	AE-100655-01	
21		Capacitor - Compressor/Fan	See Compressor Group			

No.	Notes	MODEL COOLING CAPACITY VARIATION	RSE13	RSE13	RSE13	RSE13
			36 3A/3N	42 3A/3N	48 3A/3N	60 3A/3N
ELECTRICAL/FAN GROUP						
9	Stk	Fan Motor	51-101774-02	51-101774-02	51-102008-07	51-102008-07
11	Stk,1	Fan Blade - See Note 1	70-100580-03	70-100580-03	N/A	N/A
11	1	Fan Blade - See Note 1	70-102011-03	70-102011-03	N/A	N/A
11	Stk	Fan Blade	N/A	N/A	70-102011-04	70-102011-04
18	Stk	Contactora	42-40594-14	42-40594-14	42-40594-14	42-22464-03
19		Low Voltage Cover	See Panels - Miscellaneous			
20		Control Box Bottom	AE-100655-01	AE-100655-01	AE-100655-01	AE-100655-01
21		Capacitor - Fan	See Compressor Group			

No.	Notes	MODEL COOLING CAPACITY VARIATION	RSE13	RSE13	RSE13	RSE13
			36 4A/4N	42 4A/4N	48 4A/4N	60 4A/4N
ELECTRICAL/FAN GROUP						
9	Stk	Fan Motor	51-101774-06	51-101774-06	51-101774-05	51-101774-05
11	Stk,1	Fan Blade - See Note 1	70-100580-03	70-100580-03	N/A	N/A
11	1	Fan Blade - See Note 1	70-102011-03	70-102011-03	N/A	N/A
11	Stk	Fan Blade	N/A	N/A	70-102011-10	70-102011-10
18	Stk	Contactora	42-40594-14	42-40594-14	42-40594-14	42-22464-03
19		Low Voltage Cover	See Panels - Miscellaneous			
20		Control Box Bottom	AE-100655-01	AE-100655-01	AE-100655-01	AE-100655-01
21		Capacitor - Fan	See Compressor Group			

No.	Notes	MODEL COOLING CAPACITY VARIATION	RSE13	RSE13		
			48 5A	60 5A		
ELECTRICAL/FAN GROUP						
9	Stk	Fan Motor	51-101774-10	51-101774-10		
11	Stk	Fan Blade	70-102011-10	70-102011-10		
18	Stk	Contactora	42-40594-14	42-22464-03		
19		Low Voltage Cover	See Panels - Miscellaneous			
20		Control Box Bottom	AE-100655-01	AE-100655-01		
21		Capacitor - Fan	See Compressor Group			

No.	Notes	MODEL COOLING CAPACITY VARIATION	RSE13	RSE13	RSE13	RSE13
			18 1A/1N	24 1A/1N	30 1A/1N	36 1A/1N
COIL GROUP						
13	Stk	Condenser Coil	AS-101758-03	AS-101759-03	AS-101844-03	AS-101761-03
		Distributor - Two Way (1/2 in. to 3/8 in.)	83-19988-01	83-19988-01	N/A	N/A
		Distributor - Three Way (3/8 in. to 3/8 in.)	N/A	N/A	83-17467-07	83-17467-07
		Distributor - Three Way (1/2 in. to 3/8 in.)	N/A	N/A	83-17467-06	83-17467-06
15		Valve Mounting Bracket	AE-57781-01	AE-57781-01	AE-57781-01	AE-57781-02
16		Service Valve - Suction (Before Date Code 0406)	61-21368-07	61-21368-07	61-21368-07	61-21368-08
16		Service Valve - Suction (After Date Code 0406)	61-21368-07	61-21368-07	61-21368-07	61-21368-22
17		Service Valve - Liquid	61-21368-05	61-21368-05	61-21368-05	61-21368-05
	Stk	Filter Drier	83-26186-02	83-26186-02	83-26186-02	83-26186-02

No.	Notes	MODEL COOLING CAPACITY VARIATION	RSE13	RSE13	RSE13	
			42 1A/1N	48 1A/1N	60 1A/1N	
COIL GROUP						
13	Stk	Condenser Coil	AS-101761-03	AS-101761-03	AS-101763-03	
		Distributor - Three Way (3/8 in. to 3/8 in.)	83-17467-07	83-17467-07	N/A	
		Distributor - Three Way (1/2 in. to 3/8 in.)	83-17467-06	83-17467-06	N/A	
15		Valve Mounting Bracket	AE-57781-02	AE-57781-02	AE-57781-02	
16		Service Valve - Suction (Before Date Code 0406)	61-21368-08	61-21368-08	61-21368-08	
16		Service Valve - Suction (After Date Code 0406)	61-21368-22	61-21368-22	61-21368-08	
17		Service Valve - Liquid	61-21368-05	61-21368-05	61-21368-05	
	Stk	Filter Drier	83-26186-02	83-26186-02	83-26186-02	

No.	Notes	MODEL COOLING CAPACITY VARIATION	RSE13	RSE13	RSE13	RSE13
			36 3A/3N	42 3A/3N	48 3A/3N	60 3A/3N
COIL GROUP						
13	Stk	Condenser Coil	AS-101761-03	AS-101761-03	AS-101761-03	AS-101763-03
		Distributor - Three Way (3/8 in. to 3/8 in.)	83-17467-07	83-17467-07	83-17467-07	N/A
		Distributor - Three Way (1/2 in. to 3/8 in.)	83-17467-06	83-17467-06	83-17467-06	N/A
15		Valve Mounting Bracket	AE-57781-02	AE-57781-02	AE-57781-02	AE-57781-02
16		Service Valve - Suction	61-21368-22	61-21368-08	61-21368-08	61-21368-08
17		Service Valve - Liquid	61-21368-05	61-21368-05	61-21368-05	61-21368-05
	Stk	Filter Drier	83-26186-02	83-26186-02	83-26186-02	83-26186-02

No.	Notes	MODEL COOLING CAPACITY VARIATION	RSE13	RSE13	RSE13	RSE13
			36 4A/4N	42 4A/4N	48 4A/4N	60 4A/4N
COIL GROUP						
13	Stk	Condenser Coil	AS-101761-03	AS-101761-03	AS-101761-03	AS-101763-03
		Distributor - Three Way (3/8 in. to 3/8 in.)	83-17467-07	83-17467-07	83-17467-07	N/A
		Distributor - Three Way (1/2 in. to 3/8 in.)	83-17467-06	83-17467-06	83-17467-06	N/A
15		Valve Mounting Bracket	AE-57781-02	AE-57781-02	AE-57781-02	AE-57781-02
16		Service Valve - Suction	61-21368-22	61-21368-08	61-21368-08	61-21368-08
17		Service Valve - Liquid	61-21368-05	61-21368-05	61-21368-05	61-21368-05
	Stk	Filter Drier	83-26186-02	83-26186-02	83-26186-02	83-26186-02

No.	Notes	MODEL COOLING CAPACITY VARIATION	RSE13	RSE13		
			48 5A	60 5A		
COIL GROUP						
13	Stk	Condenser Coil	AS-101761-03	AS-101763-03		
		Distributor - Three Way (3/8 in. to 3/8 in.)	83-17467-07	N/A		
		Distributor - Three Way (1/2 in. to 3/8 in.)	83-17467-06	N/A		
15		Valve Mounting Bracket	AE-57781-02	AE-57781-02		
16		Service Valve - Suction	61-21368-08	61-21368-08		
17		Service Valve - Liquid	61-21368-05	61-21368-05		
	Stk	Filter Drier	83-26186-02	83-26186-02		

No.	Notes	MODEL COOLING CAPACITY VARIATION	RSE13	RSE13	RSE13	RSE13
			18 1A	18 1N	24 1A	24 1N
COMPRESSOR GROUP						
		Compressor ID:	7276		7402	
12	Stk	Compressor	55-101545-05S		55-101545-17	
	Stk	Muffler/Check Valve	83-101828-01		83-101828-01	
21	Stk	Capacitor - Compressor/Fan	43-26261-04		43-101665-44	
		Compressor ID:	7401		7729	
12	Stk	Compressor	55-101545-16		55-101545-28S	
	Stk	Check Valve	N/A		83-102440-01	
	Stk	Muffler/Check Valve	83-101828-01		N/A	
21	Stk	Capacitor - Compressor/Fan	43-26261-04		43-101665-44	
		Compressor ID:	7728		7277	
12	Stk	Compressor	55-101545-26S		55-101545-06S	
	Stk	Check Valve	83-102440-01		N/A	
	Stk	Muffler/Check Valve	N/A		83-101828-01	
21	Stk	Capacitor - Compressor/Fan	43-26261-04		43-101665-44	
		Compressor ID:	7652	8341	7653	8342
12	Stk	Compressor	55-100835-30S	55-102045-67S	55-100835-07S	55-102045-68S
21	Stk	Capacitor - Compressor/Fan	43-26261-03	43-101665-03	43-101665-44	43-101665-44
	Stk	Compressor Wiring Harness (Molded Plug)	45-100834-80	45-100834-80	45-100834-80	45-100834-80

No.	Notes	MODEL COOLING CAPACITY VARIATION	RSE13	RSE13	RSE13	RSE13
			30 1A	30 1N	36 1A	36 1N
COMPRESSOR GROUP						
		Compressor ID:	7278		7404 / 7675	
12	Stk	Compressor	55-101545-07S		55-101545-19S	
	Stk	Muffler/Check Valve	83-101828-01		83-101828-01	
21	Stk	Capacitor - Compressor/Fan	43-101665-44		43-26261-09	
		Compressor ID:	7403		7279	
12	Stk	Compressor	55-101545-18		55-101545-08S	
	Stk	Muffler/Check Valve	83-101828-01		83-101828-01	
21	Stk	Capacitor - Compressor/Fan	43-101665-44		43-26261-15	
		Compressor ID:	7654	8343	7655	8344
12	Stk	Compressor	55-100835-17S	55-102045-69S	55-100835-25S	55-102045-70S
21	Stk	Capacitor - Compressor/Fan	43-26271-41	43-101665-41	43-26261-15	43-101665-15
	Stk	Compressor Wiring Harness (Molded Plug)	45-100834-80	45-100834-80	45-100834-80	45-100834-80

No.	Notes	MODEL COOLING CAPACITY VARIATION	RSE13	RSE13	RSE13	RSE13
			42 1A	42 1N	48 1A	48 1N
COMPRESSOR GROUP						
		Compressor ID:	7676 / 7280		7677 / 7281	
12	Stk	Compressor	55-101545-15S		55-23148-35S	
21	Stk	Capacitor - Compressor/Fan	43-26261-17		43-26271-39	
		Compressor ID:	7656	8345	7657	8346
12	Stk	Compressor	55-100835-10S	55-102045-71S	55-100835-53S	55-102045-72S
21	Stk	Capacitor - Compressor/Fan	43-26261-17	43-101665-17	43-26261-38	43-101665-38
	Stk	Compressor Wiring Harness (Molded Plug)	45-100834-80	45-100834-80	45-100834-80	45-100834-80

No.	Notes	MODEL COOLING CAPACITY VARIATION	RSE13	RSE13		
			60 1A	60 1N		
COMPRESSOR GROUP						
		Compressor ID:	7678 / 7282			
12	Stk	Compressor	55-23148-37S			
21	Stk	Capacitor - Compressor/Fan	43-26271-47			
		Compressor ID:	7658	8347		
12	Stk	Compressor	55-100835-18S	55-102045-73S		
21	Stk	Capacitor - Compressor/Fan	43-26261-30	43-101665-30		
	Stk	Compressor Wiring Harness (Molded Plug)	45-100834-80	45-100834-80		

No.	Notes	MODEL COOLING CAPACITY VARIATION	RSE13	RSE13	RSE13	RSE13
			36 3A	42 3A	48 3A	60 3A
COMPRESSOR GROUP						
		Compressor ID:	7741	7745	7798	7804
12	Stk	Compressor	55-101545-39S	55-102282-16S	55-102282-18S	55-102282-24S
21	Stk	Capacitor - Fan	43-100509-59	43-100509-59	43-100509-60	43-100509-60
	Stk	Muffler/Check Valve	83-101828-01	N/A	N/A	N/A
		Compressor ID:	7740	7744	7797	7803
12	Stk	Compressor	55-100835-34S	55-100835-36S	55-100835-65S	55-100835-38S
21	Stk	Capacitor - Fan	43-100509-59	43-100509-59	43-100509-60	43-100509-60
	Stk	Compressor Wiring Harness (Molded Plug)	45-100834-80	45-100834-80	45-100834-80	45-100834-80

No.	Notes	MODEL COOLING CAPACITY VARIATION	RSE13	RSE13	RSE13	RSE13
			36 3N	42 3N	48 3N	60 3N
COMPRESSOR GROUP						
		Compressor ID:	8372	8374	8376	8378
12	Stk	Compressor	55-102045-74S	55-102045-76S	55-102045-78S	55-102045-80S
21	Stk	Capacitor - Fan	43-101666-59	43-101666-59	43-101666-60	43-101666-60
	Stk	Compressor Wiring Harness (Molded Plug)	45-100834-80	45-100834-80	45-100834-80	45-100834-80

No.	Notes	MODEL COOLING CAPACITY VARIATION	RSE13	RSE13	RSE13	RSE13
			36 4A	42 4A	48 4A	60 4A
COMPRESSOR GROUP						
		Compressor ID:	7743	7796	7800	7806
12	Stk	Compressor	55-101545-40S	55-102282-17S	55-102282-19S	55-102282-25S
21	Stk	Capacitor - Fan	43-100509-59	43-100509-59	43-100509-59	43-100509-59
	Stk	Muffler/Check Valve	83-101828-01	N/A	N/A	N/A
		Compressor ID:	7742	7746	7799	7805
12	Stk	Compressor	55-100835-35S	55-100835-37S	55-100835-66S	55-100835-39S
21	Stk	Capacitor - Fan	43-100509-59	43-100509-59	43-100509-59	43-100509-59
	Stk	Compressor Wiring Harness (Molded Plug)	45-100834-80	45-100834-80	45-100834-80	45-100834-80

No.	Notes	MODEL COOLING CAPACITY VARIATION	RSE13	RSE13	RSE13	RSE13
			36 4N	42 4N	48 4N	60 4N
COMPRESSOR GROUP						
		Compressor ID:	8373	8375	8377	8379
12	Stk	Compressor	55-102045-75S	55-102045-77S	55-102045-79S	55-102045-81S
21	Stk	Capacitor - Fan	43-101666-59	43-101666-59	43-101666-59	43-101666-59
	Stk	Compressor Wiring Harness (Molded Plug)	45-100834-80	45-100834-80	45-100834-80	45-100834-80

No.	Notes	MODEL COOLING CAPACITY VARIATION	RSE13	RSE13		
			48 5A	60 5A		
COMPRESSOR GROUP						
		Compressor ID:	7802	7808		
12	Stk	Compressor	55-102282-20S	55-102282-26S		
21	Stk	Capacitor - Fan	43-100509-59	43-100509-59		
	Stk	Muffler/Check Valve	N/A	N/A		
		Compressor ID:	7801	7807		
12	Stk	Compressor	55-100835-67S	55-100835-48S		
21	Stk	Capacitor - Fan	43-100509-59	43-100509-59		
	Stk	Compressor Wiring Harness (Molded Plug)	45-100834-80	45-100834-80		

No.	Notes	MODEL COOLING CAPACITY VARIATION	RSE13 ALL ALL
ACCESORIES			
		Low Ambient Control	RXAD-A04
		Compressor Time Delay Control	RXMD-B01
		High Pressure Control	RXAB-A03
		Low Pressure Control	RXAC-A03



Exploded View



Valve Mounting Assembly

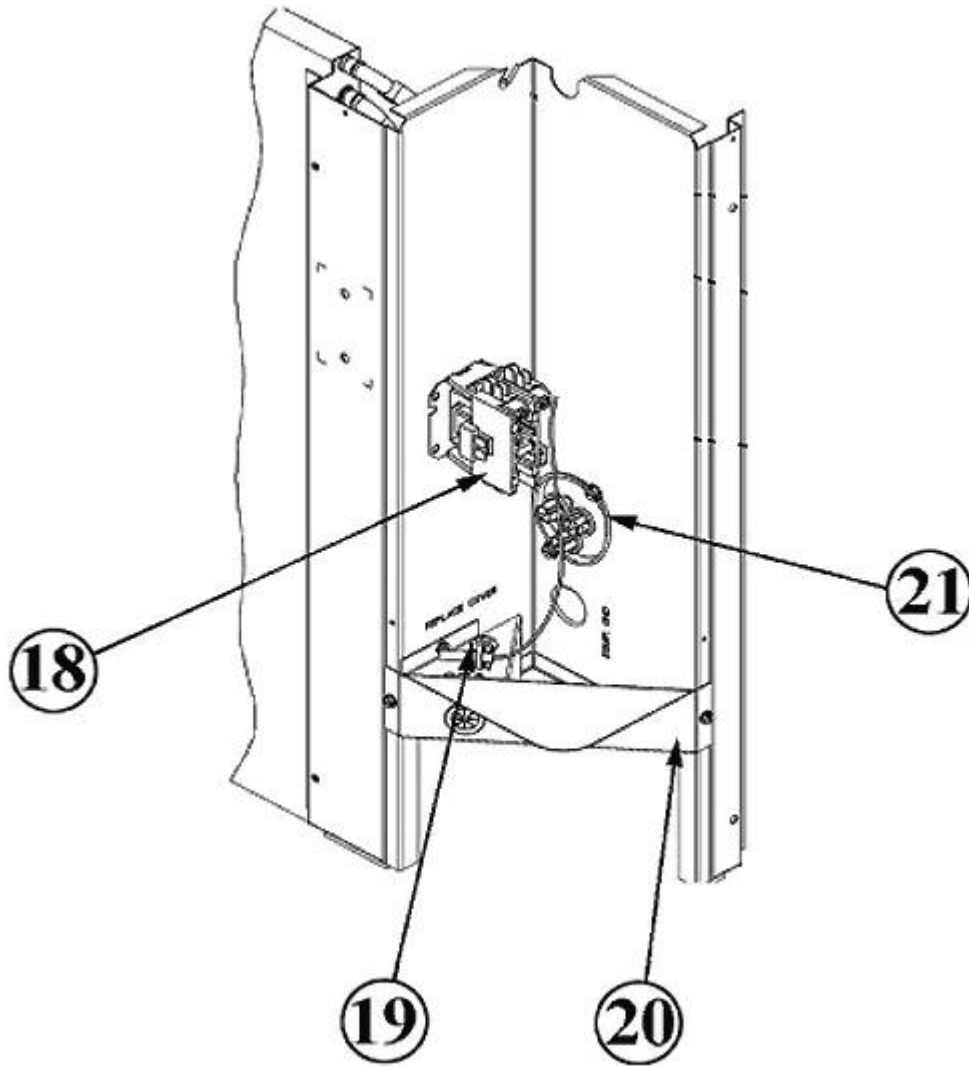

Control Box

NOTES

Stk It is recommended that stock be maintained for this part.

N/A Not Applicable

- 1 70-100580-03 / 70-100580-04 is a 3-blade design, and 70-102011-03 / 70-102011-04 / 70-102011-10 is a 2-blade design. The replacement fan blades are interchangeable on the listed units, and either may be used for replacement.
- 2 This compressor should be replaced with the designated Copleland scroll (55-100835 series) and the specified Retrofit Kit. **USE OF THE RETROFIT KIT IS REQUIRED WHEN PERFORMING THIS REPLACEMENT.** Failure to use the kit will greatly increase the likelihood of future compressor failure and will void the compressor warranty.
- 3 ICECO Gray Top Panels