

This Owner's Manual is provided and hosted by [Appliance Factory Parts](#).



COMFORT-AIRE RSG120-A4 Owner's Manual

[Shop genuine replacement parts for COMFORT-AIRE
RSG120-A4](#)



[Find Your COMFORT-AIRE HVAC Parts - Select From 1486 Models](#)

----- Manual continues below -----



RSG

Parts List
22-July-2011



This parts list is current as of the above revision date.

Form Number: 92-42810-RSG

Table of Contents

Model Explanation	Page 3
Parts Numbers	
Panels - Miscellaneous 078-125	Page 4
Panels - Miscellaneous 150-240	Page 5
Electrical Group	Page 6
Fan Group	Page 7
Coil Parts	Page 8
Compressor Group	Page 9
Accessories	Page 9
Drawings/Photographs	
Exploded View 06-07	Page 10
Exploded View 10-12	Page 11
Exploded View 15-20	Page 12
Control Box Assembly 06-07	Page 13
Control Box Assembly 10-20	Page 13
Compressor Assembly 10-20	Page 14
Notes	Page 15

MODEL NUMBER EXPLANATION

R	S	G	0	7	8	A	4
1			2			3	

- (1) **SERIES**
- (2) **COOLING CAPACITY**
 078 = 6.5 Tons 150 = 12.5 Tons
 090 = 7.5 Tons 180 = 15 Tons
 120 = 10 Tons 240 = 20 Tons
 125 = 10 Tons
- (3) **OPTIONS**

SERIAL NUMBER EXPLANATION

7	7	4	7	F	0	7	0	1	9	9	9	9	9
1				2	3		4	5					

- (1) **COMPRESSOR IDENTIFICATION NUMBER**
- (2) **PRODUCTION LOCATION**
- (3) **WEEK OF PRODUCTION**
- (4) **YEAR OF PRODUCTION**
- (5) **PRODUCTION NUMBER**

No.	Notes	MODEL COOLING CAPACITY VARIATIONS	RSG 078 A3	RSG 078 A4	RSG 078 A5	RSG 090 A3	RSG 090 A4	RSG 090 A5	
PANELS, MISCELLANEOUS PARTS									
1		Base Pan	AS-58426-13C	AS-58426-13C	AS-58426-13C	AS-58426-13C	AS-58426-13C	AS-58426-13C	
3		Button Plug	45-22980-07	45-22980-07	45-22980-07	45-22980-07	45-22980-07	45-22980-07	
4		Cabinet	AS-100609-07C	AE-100609-07	AE-100609-07	AE-100609-07	AE-100609-07	AE-100609-07	
5		Top Panel	AS-100618-05C	AE-100618-05	AE-100618-05	AE-100618-05	AE-100618-05	AE-100618-05	
8		Grille	95-100906-05	95-100906-05	95-100906-05	95-100906-05	95-100906-05	95-100906-05	
9		Control Box	AE-100633-01	AE-100633-01	AE-100633-01	AE-100633-01	AE-100633-01	AE-100633-01	
10		Access Panel	AS-100617-07C	AE-100617-07	AE-100617-07	AE-100617-07	AE-100617-07	AE-100617-07	
13a		Service Valve (Liquid)	See Coil Group						
13b		Service Valve (Suction)	See Coil Group						
17		Adapter Plate	AE-54609-02	AE-54609-02	AE-54609-02	AE-54609-02	AE-54609-02	AE-54609-02	
		Mounting Bracket - Service Valve (Before F3310)	AE-102833-01	AE-102833-01	AE-102833-01	AE-102833-01	AE-102833-01	AE-102833-01	
		Mounting Bracket - Service Valve (After F3310)	AE-102833-02	AE-102833-02	AE-102833-02	AE-102833-02	AE-102833-02	AE-102833-02	
		Valve Mounting Bracket	AE-56389-02	AE-56389-02	AE-56389-02	AE-56389-02	AE-56389-02	AE-56389-02	

No.	Notes	MODEL COOLING CAPACITY VARIATIONS	RSG 120 A3	RSG 120 A4	RSG 120 A5	RSG 125 A3	RSG 125 A4	RSG 125 A5
PANELS, MISCELLANEOUS PARTS								
1		Base Rail - End	AE-90925-01	AE-90925-01	AE-90925-01	AE-90925-01	AE-90925-01	AE-90925-01
2		Base Rail - Side	AE-90925-03	AE-90925-03	AE-90925-03	AE-90925-03	AE-90925-03	AE-90925-03
3		Middle Support Base Rail	AE-90925-05	AE-90925-05	AE-90925-05	AE-90925-05	AE-90925-05	AE-90925-05
4		Base Pan	AS-90929-02C	AS-90929-02C	AS-90929-02C	AS-90929-02C	AS-90929-02C	AS-90929-02C
5		Wire Grille	95-42507-01	95-42507-01	95-42507-01	95-42507-01	95-42507-01	95-42507-01
6		Access Panel - Front	AS-90937-01C	AS-90937-01C	AS-90937-01C	AS-90937-01C	AS-90937-01C	AS-90937-01C
7		Access Panel - Rear	AS-90938-01C	AS-90938-01C	AS-90938-01C	AS-90938-01C	AS-90938-01C	AS-90938-01C
8		Corner Post (4)	AS-90930-01C	AS-90930-01C	AS-90930-01C	AS-90930-01C	AS-90930-01C	AS-90930-01C
9		Louvered Panel (4)	AS-90944-08C	AS-90944-08C	AS-90944-08C	AS-90944-08C	AS-90944-08C	AS-90944-08C
10		Center Post	AS-90931-01C	AS-90931-01C	AS-90931-01C	AS-90931-01C	AS-90931-01C	AS-90931-01C
11		Connection Panel - Before F3310	AS-90936-02C	AS-90936-02C	AS-90936-02C	AS-90936-02C	AS-90936-02C	AS-90936-02C
11		Connection Panel - After F3310	AS-90936-04C	AS-90936-04C	AS-90936-04C	AS-90936-04C	AS-90936-04C	AS-90936-04C
12		Top Panel	AS-90942-02C	AS-90942-02C	AS-90942-02C	AS-90942-02C	AS-90942-02C	AS-90942-02C
13		Venturi Ring	AS-90632-01C	AS-90632-01C	AS-90632-01C	AS-90632-01C	AS-90632-01C	AS-90632-01C
14		Control Box Cover	AS-90935-01C	AS-90935-01C	AS-90935-01C	AS-90935-01C	AS-90935-01C	AS-90935-01C
15		Control Box	AS-90933-02	AS-90933-02	AS-90933-02	AS-90933-02	AS-90933-02	AS-90933-02
16		Control Box Mounting Bracket - Side	AE-90934-01	AE-90934-01	AE-90934-01	AE-90934-01	AE-90934-01	AE-90934-01
17		Control Box Mounting Bracket - Top	AE-90934-02	AE-90934-02	AE-90934-02	AE-90934-02	AE-90934-02	AE-90934-02
18		Control Box Mounting Bracket - Bottom	AE-90934-03	AE-90934-03	AE-90934-03	AE-90934-03	AE-90934-03	AE-90934-03
19		Guard for High Pressure Control;	AS-76160-01C	AS-76160-01C	AS-76160-01C	AS-76160-01C	AS-76160-01C	AS-76160-01C
20		Hole Plug	45-40356-10	45-40356-10	45-40356-10	45-40356-10	45-40356-10	45-40356-10
		Mounting Bracket - Service Valve (Before F3310)	AE-102833-01	AE-102833-01	AE-102833-01	AE-102833-01	AE-102833-01	AE-102833-01
		Mounting Bracket - Service Valve (After F3310)	AE-102833-02	AE-102833-02	AE-102833-02	AE-102833-02	AE-102833-02	AE-102833-02
		Switch Mounting Bracket	AE-90946-01	AE-90946-01	AE-90946-01	AE-90946-01	AE-90946-01	AE-90946-01

No.	Notes	MODEL COOLING CAPACITY VARIATIONS	RSG 150 A3	RSG 150 A4	RSG 150 A5	RSG 180 A3	RSG 180 A4	RSG 180 A5
PANELS, MISCELLANEOUS PARTS								
1		Base Rail - End	AE-90925-01	AE-90925-01	AE-90925-01	AE-90925-01	AE-90925-01	AE-90925-01
2		Base Rail - Side	AE-90925-04	AE-90925-04	AE-90925-04	AE-90925-01	AE-90925-01	AE-90925-01
3		Middle Support Base Rail	AE-90925-05	AE-90925-05	AE-90925-05	AE-90925-05	AE-90925-05	AE-90925-05
4		Base Pan	AS-90929-04C	AS-90929-04C	AS-90929-04C	AS-90929-05C	AS-90929-05C	AS-90929-05C
5		Wire Grille	95-42507-01	95-42507-01	95-42507-01	95-42507-01	95-42507-01	95-42507-01
6		Access Panel - Front	AS-90937-01C	AS-90937-01C	AS-90937-01C	AS-90937-01C	AS-90937-01C	AS-90937-01C
7		Access Panel - Rear	AS-90938-01C	AS-90938-01C	AS-90938-01C	AS-90938-01C	AS-90938-01C	AS-90938-01C
8		Corner Post (4)	AS-90930-01C	AS-90930-01C	AS-90930-01C	AS-90930-01C	AS-90930-01C	AS-90930-01C
9		Louvered Panel (4)	AS-90944-03C	AS-90944-03C	AS-90944-03C	AS-90944-01C	AS-90944-01C	AS-90944-01C
10		Center Post	AS-90931-01C	AS-90931-01C	AS-90931-01C	AS-90931-01C	AS-90931-01C	AS-90931-01C
11		Connection Panel - Before F3310	AS-90936-02C	AS-90936-02C	AS-90936-02C	AS-90936-01C	AS-90936-01C	AS-90936-01C
11		Connection Panel - After F3310	AS-90936-04C	AS-90936-04C	AS-90936-04C	AS-90936-03C	AS-90936-03C	AS-90936-03C
12		Top Panel	AS-90942-04C	AS-90942-04C	AS-90942-04C	AS-90942-01C	AS-90942-01C	AS-90942-01C
13		Venturi Ring	AS-90632-01C	AS-90632-01C	AS-90632-01C	AS-90632-01C	AS-90632-01C	AS-90632-01C
14		Control Box Cover	AS-90935-01C	AS-90935-01C	AS-90935-01C	AS-90935-01C	AS-90935-01C	AS-90935-01C
15		Control Box	AS-90933-02	AS-90933-02	AS-90933-02	AS-90933-02	AS-90933-02	AS-90933-02
16		Control Box Mounting Bracket - Side	AE-90934-01	AE-90934-01	AE-90934-01	AE-90934-01	AE-90934-01	AE-90934-01
17		Control Box Mounting Bracket - Top	AE-90934-02	AE-90934-02	AE-90934-02	AE-90934-02	AE-90934-02	AE-90934-02
18		Control Box Mounting Bracket - Bottom	AE-90934-03	AE-90934-03	AE-90934-03	AE-90934-03	AE-90934-03	AE-90934-03
19		Guard for High Pressure Control;	AS-76160-01C	AS-76160-01C	AS-76160-01C	AS-76160-01C	AS-76160-01C	AS-76160-01C
20		Hole Plug	45-40356-10	45-40356-10	45-40356-10	45-40356-10	45-40356-10	45-40356-10
		Mounting Bracket - Service Valve (Before F3310)	AE-102833-01	AE-102833-01	AE-102833-01	AE-102833-01	AE-102833-01	AE-102833-01
		Mounting Bracket - Service Valve (After F3310)	AE-102833-02	AE-102833-02	AE-102833-02	AE-102833-02	AE-102833-02	AE-102833-02
		Switch Mounting Bracket	AE-90946-01	AE-90946-01	AE-90946-01	AE-90946-01	AE-90946-01	AE-90946-01

No.	Notes	MODEL COOLING CAPACITY VARIATIONS	RSG 240 A3	RSG 240 A4	RSG 240 A5			
PANELS, MISCELLANEOUS PARTS								
1		Base Rail - End	AE-90925-01	AE-90925-01	AE-90925-01			
2		Base Rail - Side	AE-90925-01	AE-90925-01	AE-90925-01			
3		Middle Support Base Rail	AE-90925-05	AE-90925-05	AE-90925-05			
4		Base Pan	AS-90929-01C	AS-90929-01C	AS-90929-01C			
5		Wire Grille	95-42507-01	95-42507-01	95-42507-01			
6		Access Panel - Front	AS-90937-01C	AS-90937-01C	AS-90937-01C			
7		Access Panel - Rear	AS-90938-01C	AS-90938-01C	AS-90938-01C			
8		Corner Post (4)	AS-90930-01C	AS-90930-01C	AS-90930-01C			
9		Louvered Panel (4)	AS-90944-01C	AS-90944-01C	AS-90944-01C			
10		Center Post	AS-90931-01C	AS-90931-01C	AS-90931-01C			
11		Connection Panel - Before F3310	AS-90936-01C	AS-90936-01C	AS-90936-01C			
11		Connection Panel - After F3310	AS-90936-03C	AS-90936-03C	AS-90936-03C			
12		Top Panel	AS-90942-01C	AS-90942-01C	AS-90942-01C			
13		Venturi Ring	AS-90632-01C	AS-90632-01C	AS-90632-01C			
14		Control Box Cover	AS-90935-01C	AS-90935-01C	AS-90935-01C			
15		Control Box	AS-90933-02	AS-90933-02	AS-90933-02			
16		Control Box Mounting Bracket - Side	AE-90934-01	AE-90934-01	AE-90934-01			
17		Control Box Mounting Bracket - Top	AE-90934-02	AE-90934-02	AE-90934-02			
18		Control Box Mounting Bracket - Bottom	AE-90934-03	AE-90934-03	AE-90934-03			
19		Guard for High Pressure Control;	AS-76160-01C	AS-76160-01C	AS-76160-01C			
20		Hole Plug	45-40356-10	45-40356-10	45-40356-10			
		Mounting Bracket - Service Valve (Before F3310)	AE-102833-01	AE-102833-01	AE-102833-01			
		Mounting Bracket - Service Valve (After F3310)	AE-102833-02	AE-102833-02	AE-102833-02			
		Switch Mounting Bracket	AE-90946-01	AE-90946-01	AE-90946-01			

No.	Notes	MODEL COOLING CAPACITY VARIATIONS	RSG 078 A3	RSG 078 A4	RSG 078 A5	RSG 090 A3	RSG 090 A4	RSG 090 A5
ELECTRIC GROUP								
14	Stk	Control Transformer	46-41930-01	46-41930-01	46-22384-01	46-41930-01	46-41930-01	46-22384-01
15	Stk	Contacto	42-22464-01	42-22464-01	42-22464-01	42-22464-02	42-22464-01	42-22464-01
18		Low Ambient Control	See Coil Group					
		Control Bracket - Low Ambient Control	AE-90946-01	AE-90946-01	AE-90946-01	AE-90946-01	AE-90946-01	AE-90946-01

No.	Notes	MODEL COOLING CAPACITY VARIATIONS	RSG 120 A3	RSG 120 A4	RSG 120 A5	RSG 125 A3	RSG 125 A4	RSG 125 A5
ELECTRICAL GROUP								
32	Stk	Contacto	42-42667-03 (1)	42-42667-03 (1)	42-42667-03 (1)	42-42667-02 (2)	42-42667-02 (2)	42-42667-02 (2)
33		Terminal Block	N/A	N/A	N/A	45-41669-01	45-41669-01	45-41669-01
34	Stk	Relay	N/A	N/A	N/A	42-19736-07	42-19736-07	42-19736-07
35	Stk	Transformer	46-42515-01	46-42505-02	46-42505-02	46-42515-01	46-42505-02	46-42505-02
36	Stk	Time Delay Relay	N/A	N/A	N/A	42-22906-01	42-22906-01	42-22906-01
37		High Pressure Control	See Coil Group					
38		Low Pressure Control	See Coil Group					
39		Low Ambient Control	See Coil Group					
		Wiring Harness - Outdoor Fan Motors	45-42522-60	45-42522-60	45-42522-60	45-42522-60	45-42522-60	45-42522-60
		Wiring Harness - Compressor	45-42522-63	45-42522-63	45-42522-63	45-42522-61	45-42522-61	45-42522-61

No.	Notes	MODEL COOLING CAPACITY VARIATIONS	RSG 150 A3	RSG 150 A4	RSG 150 A5	RSG 180 A3	RSG 180 A4	RSG 180 A5
ELECTRICAL GROUP								
32	Stk	Contacto	42-42667-03 (2)	42-42667-03 (2)	42-42667-03 (2)	42-42667-03 (2)	42-42667-03 (2)	42-42667-03 (2)
33		Terminal Block	45-41669-01	45-41669-01	45-41669-01	45-41669-01	45-41669-01	45-41669-01
34	Stk	Relay	42-19736-07	42-19736-07	42-19736-07	42-19736-07	42-19736-07	42-19736-07
35	Stk	Transformer	46-42515-01	46-42505-02	46-42505-02	46-42515-01	46-42515-02	46-42515-02
36	Stk	Time Delay Relay	42-22906-01	42-22906-01	42-22906-01	42-22906-01	42-22906-01	42-22906-01
37		High Pressure Control	See Coil Group					
38		Low Pressure Control	See Coil Group					
39		Low Ambient Control	See Coil Group					
		Wiring Harness - Outdoor Fan Motors	45-42522-60	45-42522-60	45-42522-60	45-42522-56	45-42522-56	45-42522-56
		Wiring Harness - Compressor	45-42522-61	45-42522-61	45-42522-61	45-42522-59	45-42522-59	45-42522-59

No.	Notes	MODEL COOLING CAPACITY VARIATIONS	RSG 240 A3	RSG 240 A4	RSG 240 A5			
ELECTRICAL GROUP								
32	Stk	Contacto	42-42667-01 (2)	42-42667-03 (2)	42-42667-03 (2)			
33		Terminal Block	45-41669-01	45-41669-01	45-41669-01			
34	Stk	Relay	42-19736-07	42-19736-07	42-19736-07			
35	Stk	Transformer	46-42515-04	46-42515-05	46-42515-05			
36	Stk	Time Delay Relay	42-22906-01	42-22906-01	42-22906-01			
37		High Pressure Control	See Coil Group					
38		Low Pressure Control	See Coil Group					
39		Low Ambient Control	See Coil Group					
		Wiring Harness - Outdoor Fan Motors	45-42522-56	45-42522-56	45-42522-56			
		Wiring Harness - Compressor	45-42522-94	45-42522-94	45-42522-94			

No.	Notes	MODEL COOLING CAPACITY VARIATIONS	RSG 078 A3	RSG 078 A4	RSG 078 A5	RSG 090 A3	RSG 090 A4	RSG 090 A5
FAN GROUP								
6	Stk	Fan Blade	70-42484-01	70-42484-01	70-42484-01	70-42484-01	70-42484-01	70-42484-01
7	Stk	Fan Motor	51-100998-13	51-100998-12	51-100998-14	51-100998-13	51-100998-12	51-100998-14
16	Stk	Capacitor - Fan Motor	43-100496-12	43-100496-12	43-100496-11	43-100496-12	43-100496-12	43-100496-11

No.	Notes	MODEL COOLING CAPACITY VARIATIONS	RSG 120 A3	RSG 120 A4	RSG 120 A5	RSG 125 A3	RSG 125 A4	RSG 125 A5
FAN GROUP								
24	Stk	Fan Motor	51-42534-01 (2)	51-42534-02 (2)	51-42534-03 (2)	51-42534-01 (2)	51-42534-02 (2)	51-42534-03 (2)
25	Stk	Capacitor - Fan Motor	43-100496-12 (2)	43-100496-12 (2)	43-100496-12 (2)	43-100496-12 (2)	43-100496-12 (2)	43-100496-12 (2)
26	Stk	Fan Blade	70-42572-01 (2)	70-42572-01 (2)	70-42572-01 (2)	70-42572-01 (2)	70-42572-01 (2)	70-42572-01 (2)
27		Cap/Rain Shield	56-17070-01 (2)	56-17070-01 (2)	56-17070-01 (2)	56-17070-01 (2)	56-17070-01 (2)	56-17070-01 (2)
28		Motor Mount - Outdoor Fan	70-42504-01 (2)	70-42504-01 (2)	70-42504-01 (2)	70-42504-01 (2)	70-42504-01 (2)	70-42504-01 (2)

No.	Notes	MODEL COOLING CAPACITY VARIATIONS	RSG 150 A3	RSG 150 A4	RSG 150 A5	RSG 180 A3	RSG 180 A4	RSG 180 A5
FAN GROUP								
24	Stk	Fan Motor	51-42534-01 (2)	51-42534-02 (2)	51-42534-03 (2)	51-42534-01 (3)	51-42534-02 (3)	51-42534-03 (3)
		Motor Wiring Harness	45-42522-60	45-42522-60	45-42522-60	45-42522-56	45-42522-56	45-42522-56
25	Stk	Capacitor - Fan Motor	43-100496-12 (2)	43-100496-12 (2)	43-100496-12 (2)	43-100496-12 (3)	43-100496-12 (3)	43-100496-12 (3)
26	Stk	Fan Blade	70-42572-01 (2)	70-42572-01 (2)	70-42572-01 (2)	70-42572-01 (3)	70-42572-01 (3)	70-42572-01 (3)
27		Cap/Rain Shield	56-17070-01 (2)	56-17070-01 (2)	56-17070-01 (2)	56-17070-01 (3)	56-17070-01 (3)	56-17070-01 (3)
28		Motor Mount - Outdoor Fan	70-42504-01 (2)	70-42504-01 (2)	70-42504-01 (2)	70-42504-01 (3)	70-42504-01 (3)	70-42504-01 (3)
29		Heat Sink			77-42426-01 (4)			77-42426-01 (2)
		Heat Sink Clip			77-42427-01 (2)			77-42427-01 (1)

No.	Notes	MODEL COOLING CAPACITY VARIATIONS	RSG 240 A3	RSG 240 A4	RSG 240 A5			
FAN GROUP								
24	Stk	Fan Motor	51-42534-09 (3)	51-42534-14 (3)	51-42534-11 (3)			
		Motor Wiring Harness	45-42522-56	45-42522-56	45-42522-56			
25	Stk	Capacitor - Fan Motor	43-100496-41 (3)	43-100496-12 (3)	43-100496-03 (3)			
26	Stk	Fan Blade	70-42572-03 (3)	70-42572-03 (3)	70-42572-03 (3)			
27		Cap/Rain Shield	56-17070-01 (3)	56-17070-01 (3)	56-17070-01 (3)			
28		Motor Mount - Outdoor Fan	70-42504-01 (3)	70-42504-01 (3)	70-42504-01 (3)			
29		Heat Sink			77-42426-01 (2)			
		Heat Sink Clip			77-42427-01 (1)			

No.	Notes	MODEL COOLING CAPACITY VARIATIONS	RSG 078 A3	RSG 078 A4	RSG 078 A5	RSG 090 A3	RSG 090 A4	RSG 090 A5
COIL GROUP								
2	Stk	Condenser Coil	AS-102624-01	AS-102624-01	AS-102624-01	AS-102625-01	AS-102625-01	AS-102625-01
12	Stk	High Pressure Control	47-23699-05	47-23699-05	47-23699-05	47-23699-05	47-23699-05	47-23699-05
		Distributor - 4 Way (1/2 in. to 3/8 in.) - w/o Liquid Tubes	83-17467-23	83-17467-23	83-17467-23	N/A	N/A	N/A
13a		Service Valve (Liquid)	61-21368-12	61-21368-12	61-21368-12	61-21368-12	61-21368-12	61-21368-12
13b		Service Valve (Suction) - Before F4310	61-102832-04	61-102832-04	61-102832-04	61-102832-04	61-102832-04	61-102832-04
13b		Service Valve (Suction) - After F4310	61-102832-07	61-102832-07	61-102832-07	61-102832-07	61-102832-07	61-102832-07
18	Stk	Low Ambient Control	47-102478-01	47-102478-01	47-102478-01	47-102478-01	47-102478-01	47-102478-01
	Stk	Low Pressure Control	47-101529-09	47-101529-09	47-101529-09	47-101529-09	47-101529-09	47-101529-09
	Stk	Filter Drier	83-22755-10	83-22755-10	83-22755-10	83-22755-10	83-22755-10	83-22755-10

No.	Notes	MODEL COOLING CAPACITY VARIATIONS	RSG 120 A3	RSG 120 A4	RSG 120 A5	RSG 125 A3	RSG 125 A4	RSG 125 A5
COIL GROUP								
21	Stk	Condenser Coil	AS-90900-02 (2)	AS-90900-02 (2)	AS-90900-02 (2)	AS-90900-07 (2)	AS-90900-07 (2)	AS-90900-07 (2)
		Distributor - 2 Way (1/2 in. to 3/8 in.) - w/o Liquid Tubes	83-19988-01	83-19988-01	83-19988-01	N/A	N/A	N/A
		Distributor - 2 Way (3/4 in. to 3/4 in.) - w/o Liquid Tubes	N/A	N/A	N/A	83-17467-29	83-17467-29	83-17467-29
22		Gauge Port	AS-90948-01	AS-90948-01	AS-90948-01	AS-90948-01	AS-90948-01	AS-90948-01
23		Gauge Port	AS-90948-02	AS-90948-02	AS-90948-02	AS-90948-02	AS-90948-02	AS-90948-02
		Service Valve (Liquid)	61-21368-14	61-21368-14	61-21368-14	61-21368-14	61-21368-14	61-21368-14
		Service Valve (Suction)	61-102832-02	61-102832-02	61-102832-02	61-102832-02	61-102832-02	61-102832-02
37	Stk	High Pressure Control	47-23699-05	47-23699-05	47-23699-05	47-23699-05	47-23699-05	47-23699-05
38	Stk	Low Pressure Control	47-101529-09	47-101529-09	47-101529-09	47-101529-09	47-101529-09	47-101529-09
39	Stk	Low Ambient Control	47-102478-01	47-102478-01	47-102478-01	47-102478-01	47-102478-01	47-102478-01
	Stk	Filter Drier	83-22755-13	83-22755-13	83-22755-13	83-22755-13	83-22755-13	83-22755-13

No.	Notes	MODEL COOLING CAPACITY VARIATIONS	RSG 150 A3	RSG 150 A4	RSG 150 A5	RSG 180 A3	RSG 180 A4	RSG 180 A5
COIL GROUP								
21	Stk	Condenser Coil	AS-90900-03 (2)	AS-90900-03 (2)	AS-90900-03 (2)	AS-90900-04 (2)	AS-90900-04 (2)	AS-90900-04 (2)
22		Gauge Port	AS-90948-01	AS-90948-01	AS-90948-01	AS-90948-01	AS-90948-01	AS-90948-01
23		Gauge Port	AS-90948-02	AS-90948-02	AS-90948-02	AS-90948-11	AS-90948-11	AS-90948-11
		Service Valve (Liquid)	61-21368-14	61-21368-14	61-21368-14	61-21368-14	61-21368-14	61-21368-14
		Service Valve (Suction)	61-102832-02	61-102832-02	61-102832-02	61-102832-03	61-102832-03	61-102832-03
37	Stk	High Pressure Control	47-23699-05	47-23699-05	47-23699-05	47-23699-05	47-23699-05	47-23699-05
38	Stk	Low Pressure Control	47-101529-09	47-101529-09	47-101529-09	47-101529-09	47-101529-09	47-101529-09
39	Stk	Low Ambient Control	47-102478-01	47-102478-01	47-102478-01	47-102478-01	47-102478-01	47-102478-01
		Filter Drier	83-22755-11	83-22755-11	83-22755-11	83-22755-11	83-22755-11	83-22755-11

No.	Notes	MODEL COOLING CAPACITY VARIATIONS	RSG 240 A3	RSG 240 A4	RSG 240 A5			
COIL GROUP								
21	Stk	Condenser Coil	AS-90900-05 (2)	AS-90900-05 (2)	AS-90900-05 (2)			
22		Gauge Port	AS-90948-01	AS-90948-01	AS-90948-01			
23		Gauge Port	AS-90948-11	AS-90948-11	AS-90948-11			
		Service Valve (Liquid)	61-21368-16	61-21368-16	61-21368-16			
		Service Valve (Suction)	61-102832-03	61-102832-03	61-102832-03			
37	Stk	High Pressure Control	47-23699-05	47-23699-05	47-23699-05			
38	Stk	Low Pressure Control	47-101529-09	47-101529-09	47-101529-09			
39	Stk	Low Ambient Control	47-102478-01	47-102478-01	47-102478-01			
		Filter Drier	83-22755-14	83-22755-14	83-22755-14			

No.	Notes	MODEL COOLING CAPACITY VARIATIONS	RSG 078 A3	RSG 078 A4	RSG 078 A5	RSG 090 A3	RSG 090 A4	RSG 090 A5
COMPRESSOR GROUP								
		Compressor ID:	7747	7748	7749	7753	7754	7755
11	Stk	Compressor	55-23156-16S	55-23156-17S	55-23156-18S	55-23156-20S	55-23156-21S	55-23156-22S
	Stk	Crankcase Heater	44-17402-10	44-17402-11	44-17402-12	44-17402-10	44-17402-11	44-17402-12

No.	Notes	MODEL COOLING CAPACITY VARIATIONS	RSG 120 A3	RSG 120 A4	RSG 120 A5	RSG 125 A3	RSG 125 A4	RSG 125 A5
COMPRESSOR GROUP								
		Compressor ID:	7759	7760	7761	7850	7851	7852
30	Stk	Compressor	55-102471-01S	55-102471-04S	55-102471-05S	55-102477-01S	55-102477-02S	55-102477-03S
31	Stk	Crankcase Heater	44-17402-17	44-17402-18	44-17402-19	44-17402-22 (2)	44-17402-23 (2)	44-17402-24 (2)

No.	Notes	MODEL COOLING CAPACITY VARIATIONS	RSG 150 A3	RSG 150 A4	RSG 150 A5	RSG 180 A3	RSG 180 A4	RSG 180 A5
COMPRESSOR GROUP								
		Compressor ID:	7919	7920	7921	7925	7926	7927
30	Stk	Compressor	55-102477-05S	55-102477-06	55-102477-07S	55-102477-09S	55-102477-10S	55-102477-11S
31	Stk	Crankcase Heater	44-17402-22 (2)	44-17402-23 (2)	44-17402-24 (2)	44-17402-22 (2)	44-17402-23 (2)	44-17402-23 (2)

No.	Notes	MODEL COOLING CAPACITY VARIATIONS	RSG 240 A3	RSG 240 A4	RSG 240 A5			
COMPRESSOR GROUP								
		Compressor ID:	7931	7932	7933			
30	Stk	Compressor	55-102477-13S	55-102477-14S	55-102477-15S			
31	Stk	Crankcase Heater	44-17402-17 (2)	44-17402-18 (2)	44-17402-19 (2)			

No.	Notes	MODEL COOLING CAPACITY VARIATIONS	RSG 078 ALL	RSG 090 ALL	RSG 120 ALL	RSG 125 ALL	RSG 150 ALL	RSG 180 ALL
ACCESSORY GROUP								
		Anti-Short Cycle Timer Kit	RXAT-A01	RXAT-A01	N/A	N/A	N/A	N/A
		Liquid Line Solenoid Valve	RXAV-CD078	RXAV-CD078	RXAV-CD120	RXAV-CD120	RXAV-CD120	RXAV-CD180
		Sight Glass	RXAG-A048	RXAG-A048	RXAG-A048	RXAG-A048	N/A	RXAG-A020

No.	Notes	MODEL COOLING CAPACITY	RSG 240 ALL					
ACCESSORY GROUP								
		Liquid Line Solenoid Valve	RXAV-CD180					
		Sight Glass	RXAG-A020					

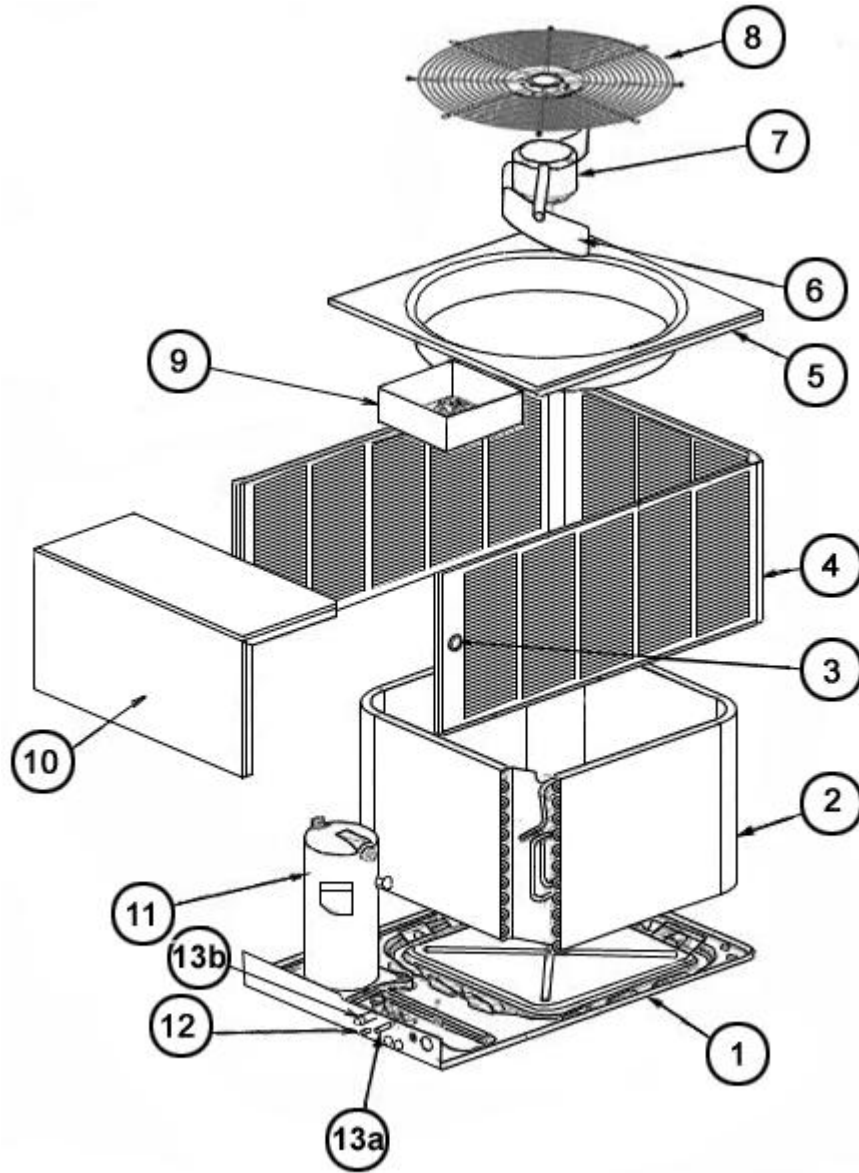

Exploded View 06-07

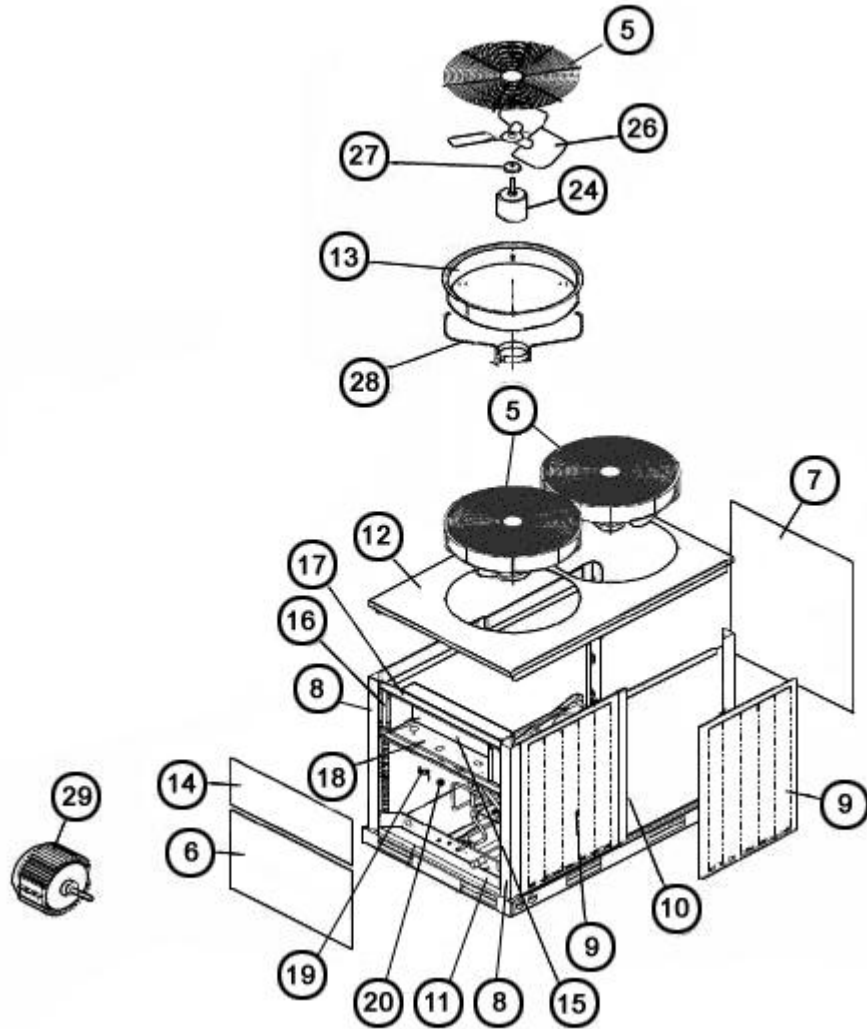

Exploded View 10-12

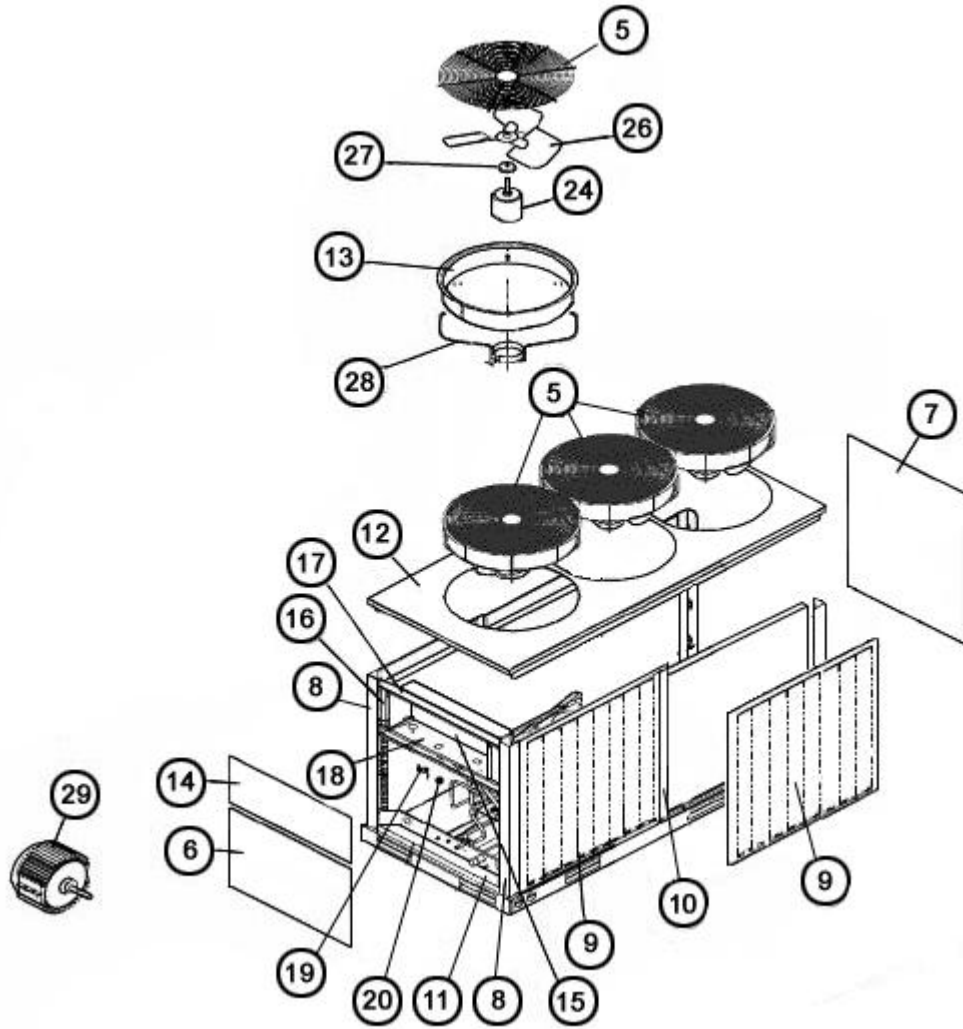

Exploded View 15-20

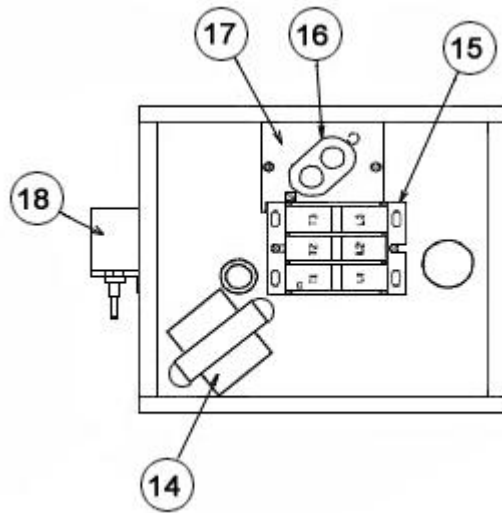

Control Box Assembly 06-07

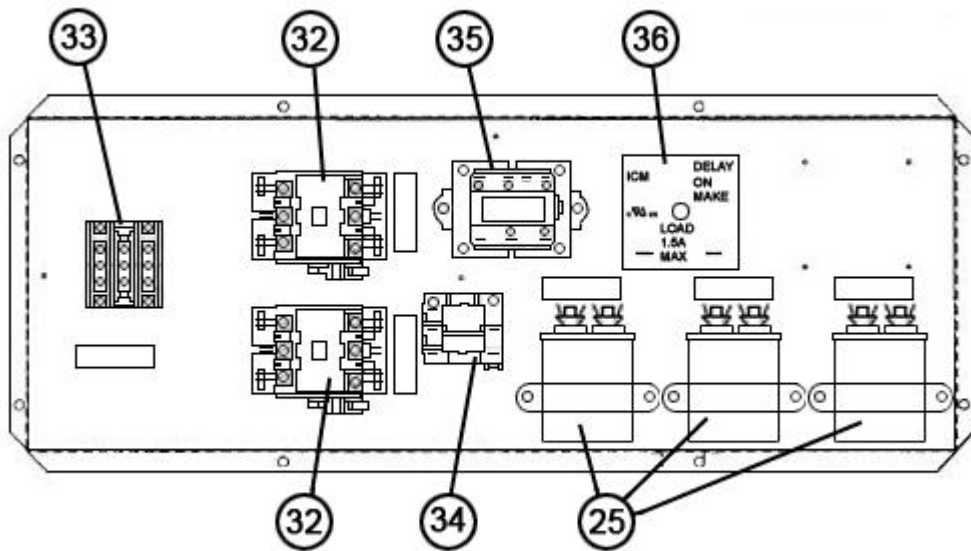

Control Box Assembly 10-20

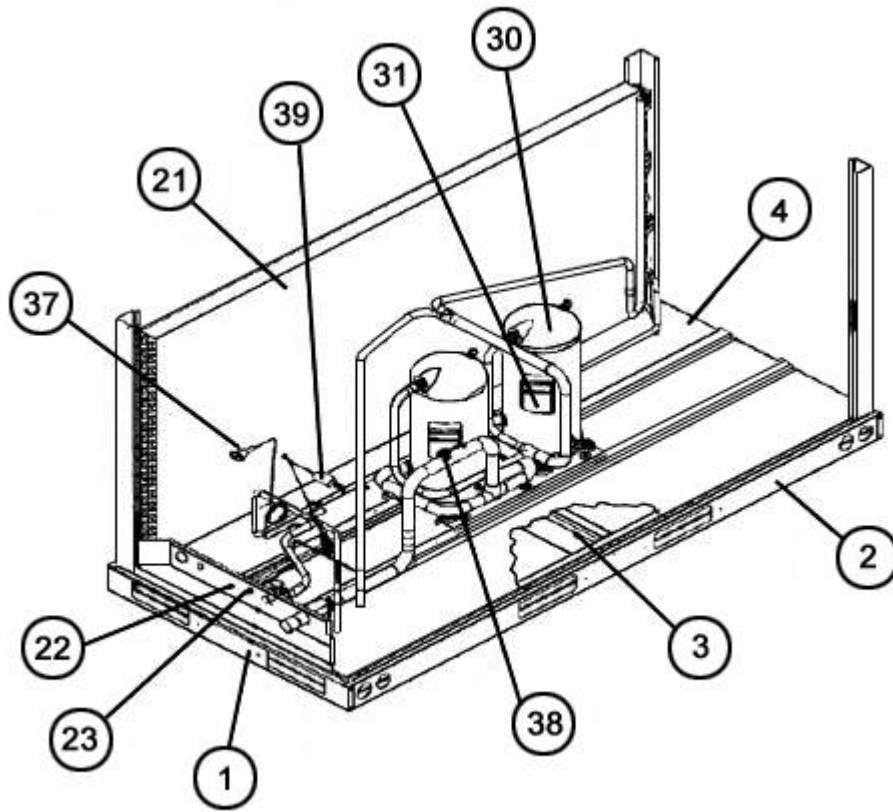

Compressor Assembly 10-20

NOTES

Stk It is recommended that stock be maintained for this part.
N/A Not Applicable