

This Owner's Manual is provided and hosted by [Appliance Factory Parts](#).



# COMFORT-AIRE HFE4821GX-1A Owner's Manual

[Shop genuine replacement parts for COMFORT-AIRE  
HFE4821GX-1A](#)



[Find Your COMFORT-AIRE HVAC Parts - Select From 1486 Models](#)

----- Manual continues below -----

# HFE-GX

HEAT CONTROLLER, INC.

Parts List  
28-March-2012



*This parts list is current as of the above revision date.*

Form Number: 92-42810-HFE-GX

# Table of Contents

Model Explanation .....	Page 3
Parts Numbers	
Panels - Miscellaneous .....	Page 4
Electrical Group .....	Page 5
Blower Group .....	Page 6
Coil Parts .....	Page 7
Heater Kits .....	Page 7
Drawings/Photographs	
Exploded View .....	Page 8
Blower Assembly .....	Page 9
Notes .....	Page 10

**MODEL NUMBER EXPLANATION**

<b>H</b>	<b>F</b>	<b>E</b>	<b>24</b>	<b>17</b>	<b>GX</b>	<b>-</b>	<b>1</b>	<b>A</b>
1	2	3	4	5	6			

- |   |  |
|---|--|
| <p><b>1 HEAT CONTROLLER SERIES</b><br/>A/C OR HP, MULTI-POSITION<br/>(X-13 MOTOR)</p> <p><b>2 CAPACITY</b><br/>24 = 18,000 - 24,000 BTU/HR<br/>36 = 30,000 - 36,000 BTU/HR<br/>38 = 30,000 - 42,000 BTU/HR<br/>48 = 42,000 - 48,000 BTU/HR<br/>60 = 60,000 BTU.HR</p> | <p><b>3 CABINET SIZE</b><br/>17= 17.5 in.<br/>21= 21 in.<br/>24= 24.5 in.</p> <p><b>4 REFRIGERANT</b><br/>GX= R410A</p> <p><b>5 VOLTAGE</b><br/>0= 115/1/60<br/>1= 208-240/1/60<br/>4= 480/3/60</p> <p><b>6 DESIGN VARIATION - A</b></p> |
|---|--|

**SERIAL NUMBER EXPLANATION**

<b>M</b>	<b>0</b>	<b>7</b>	<b>0</b>	<b>1</b>	<b>9</b>	<b>9</b>	<b>9</b>	<b>9</b>	<b>9</b>
1	2	3	4						

- |   |                            |
|---|----------------------------|
| 1 | <b>PRODUCTION LOCATION</b> |
| 2 | <b>WEEK OF PRODUCTION</b>  |
| 3 | <b>YEAR OF PRODUCTION</b>  |
| 4 | <b>PRODUCTION NUMBER</b>   |

No.	Notes	MODEL	HFE	HFE	HFE	HFE	HFE	HFE
		CAPACITY	24	24	36	36	38	48
		CABINET SIZE	17	17	17	17	21	21
		CONFIGURATION	GX	GX	GX	GX	GX	GX
		VOLTAGE	0	1	0	1	1	0
		VARIATION	A	A	A	A	A	A
<b>PANELS, SHEET METAL, MISCELLANEOUS</b>								
1		Cabinet	AE-100682-01	AE-100682-01	AE-100682-01	AE-100682-01	AE-100682-03	AE-100682-03
2		Coil Door	AE-100685-22	AE-100685-22	AE-100685-22	AE-100685-22	AE-100685-24	AE-100685-24
3		Top Cover Plate	AE-100686-01	AE-100686-01	AE-100686-01	AE-100686-01	AE-100686-02	AE-100686-02
4		Blower Door	AE-100684-21	AE-100684-21	AE-100684-21	AE-100684-21	AE-100684-22	AE-100684-22
5		Access Panel	AE-101133-21	AE-101133-21	AE-101133-21	AE-101133-21	AE-101133-21	AE-101133-21
6		Drain Pan - Vertical	See RCSL Coil Parts List					
7		Drain Pan - Horizontal	See RCSL Coil Parts List					
8		Plate - Block Off	AE-100455-01	AE-100455-01	AE-100455-01	AE-100455-01	AE-100455-01	AE-100455-01
9		Cabinet Brace	AE-101134-02	AE-101134-02	AE-101134-02	AE-101134-02	AE-101134-03	AE-101134-03
10		Middle Brace	AE-101054-01	AE-101054-01	AE-101054-01	AE-101054-01	AE-101054-02	AE-101054-02
13a		Heat Barrier	AE-100683-02	AE-100683-02	AE-100683-03	AE-100683-03	AE-100683-06	AE-100683-06
13b		Heat Barrier Side (2)	AE-104241-01	AE-104241-01	AE-104241-01	AE-104241-01	AE-104241-01	AE-104241-01
		Insulation Retainer Rod (2)	45-102868-02	45-102868-02	45-102868-02	45-102868-02	45-102868-03	45-102868-03

No.	Notes	MODEL	HFE	HFE	HFE	HFE	HFE	HFE
		CAPACITY	48	48	48	60	60	60
		CABINET SIZE	21	24	24	24	24	24
		CONFIGURATION	GX	GX	GX	GX	GX	GX
		VOLTAGE	1	0	1	0	1	4
		VARIATION	A	A	A	A	A	A
<b>PANELS, SHEET METAL, MISCELLANEOUS</b>								
1		Cabinet	AE-100682-03	AE-100682-05	AE-100682-05	AE-100682-05	AE-100682-05	AE-100682-05
2		Coil Door	AE-100685-24	AE-100685-26	AE-100685-26	AE-100685-26	AE-100685-26	AE-100685-26
3		Top Cover Plate	AE-100686-02	AE-100686-03	AE-100686-03	AE-100686-03	AE-100686-03	AE-100686-03
4		Blower Door	AE-100684-22	AE-100684-23	AE-100684-23	AE-100684-23	AE-100684-23	AE-100684-23
5		Access Panel	AE-101133-21	AE-101133-21	AE-101133-21	AE-101133-21	AE-101133-21	AE-101133-21
6		Drain Pan - Vertical	See RCSL Coil Parts List					
7		Drain Pan - Horizontal	See RCSL Coil Parts List					
8		Plate - Block Off	AE-100455-01	AE-100455-01	AE-100455-01	AE-100455-01	AE-100455-01	AE-100455-01
9		Cabinet Brace	AE-101134-03	AE-101134-04	AE-101134-04	AE-101134-04	AE-101134-04	AE-101134-04
10		Middle Brace	AE-101054-02	AE-101054-03	AE-101054-03	AE-101054-03	AE-101054-03	AE-101054-03
13a		Heat Barrier	AE-100683-06	AE-100683-07	AE-100683-07	AE-100683-08	AE-100683-08	AE-100683-08
13b		Heat Barrier Side (2)	AE-104241-01	AE-104241-01	AE-104241-01	AE-104241-01	AE-104241-01	AE-104241-01
		Insulation Retainer Rod (2)	45-102868-03	45-102868-04	45-102868-04	45-102868-04	45-102868-04	45-102868-04

No.	Notes	MODEL	HFE	HFE	HFE	HFE	HFE	HFE
		CAPACITY	24	24	36	36	38	48
		CABINET SIZE	17	17	17	17	21	21
		CONFIGURATION	GX	GX	GX	GX	GX	GX
		VOLTAGE	0	1	0	1	1	0
		VARIATION	A	A	A	A	A	A
<b>ELECTRICAL GROUP</b>								
17	Stk	Transformer	46-101944-02	46-101905-01	46-101944-02	46-101905-01	46-101905-01	46-101944-02
18	Stk	Control Board	47-102077-02	47-102077-02	47-102077-02	47-102077-02	47-102077-02	47-102077-02
		Wiring Harness - 6 pin to 6 strip leads (For T-Stat)	45-101891-01	45-101891-01	45-101891-01	45-101891-01	45-101891-01	45-101891-01
11		Terminal Block	45-23222-02	45-23222-02	45-23222-02	45-23222-02	45-23222-02	45-23222-02

No.	Notes	MODEL	HFE	HFE	HFE	HFE	HFE	HFE
		CAPACITY	48	48	48	60	60	60
		CABINET SIZE	21	24	24	24	24	24
		CONFIGURATION	GX	GX	GX	GX	GX	GX
		VOLTAGE	1	0	1	0	1	4
		VARIATION	A	A	A	A	A	A
<b>ELECTRICAL GROUP</b>								
17	Stk	Transformer	46-101905-01	46-101944-02	46-101905-01	46-101944-02	46-101905-01	46-101946-01
18	Stk	Control Board	47-102077-02	47-102077-02	47-102077-02	47-102077-02	47-102077-02	47-102077-02
		Wiring Harness - 6 pin to 6 strip leads (For T-Stat)	45-101891-01	45-101891-01	45-101891-01	45-101891-01	45-101891-01	45-101891-01
11		Terminal Block	45-23222-02	45-23222-02	45-23222-02	45-23222-02	45-23222-02	45-23222-02

No.	Notes	MODEL	HFE	HFE	HFE	HFE	HFE	HFE
		CAPACITY	24	24	36	36	38	48
		CABINET SIZE	17	17	17	17	21	21
		CONFIGURATION	GX	GX	GX	GX	GX	GX
		VOLTAGE	0	1	0	1	1	0
		VARIATION	A	A	A	A	A	A
<b>BLOWER GROUP</b>								
15	Stk	Blower Assembly (Includes items 16-22)	AS-101930-01	AS-101886-01	AS-101930-02	AS-101886-02	AS-101886-06	AS-101930-03
16		Mounting Bracket - Control Board	AE-101049-01	AE-101049-01	AE-101049-01	AE-101049-01	AE-101049-01	AE-101049-01
17		Transformer	See Electrical Group					
		Power Factor Choke	N/A	N/A	N/A	N/A	N/A	46-24256-04
18		Control Board	See Electrical Group					
19		Blower Housing w/Wheel	70-101729-01	70-101729-01	70-101729-02	70-101729-02	70-101729-03	70-101729-03
	Stk	Blower Wheel	703012	703012	703014	703014	703013	703013
20		Motor Mount - Band	70-19927-04	70-19927-04	70-19927-04	70-19927-04	70-19927-04	70-19927-04
21		Motor Mount - Arm (4)	70-19929-10	70-19929-10	70-19929-10	70-19929-10	70-19929-10	70-19929-10
22	Stk	Blower Motor (X-13)	51-102171-01	51-101879-01	51-102172-01	51-101880-01	51-101920-20	51-102173-01
23		Mounting Bracket Cover	AE-101797-01	AE-101797-01	AE-101797-01	AE-101797-01	AE-101797-01	AE-101797-01

No.	Notes	MODEL	HFE	HFE	HFE	HFE	HFE	HFE
		CAPACITY	48	48	48	60	60	60
		CABINET SIZE	21	24	24	24	24	24
		CONFIGURATION	GX	GX	GX	GX	GX	GX
		VOLTAGE	1	0	1	0	1	4
		VARIATION	A	A	A	A	A	A
<b>BLOWER GROUP</b>								
15	Stk	Blower Assembly (Includes items 16-22)	AS-101886-03	AS-101930-04	AS-101886-04	AS-101930-04	AS-101886-04	AS-101886-05
16		Mounting Bracket - Control Board	AE-101049-01	AE-101049-01	AE-101049-01	AE-101049-01	AE-101049-01	AE-101049-01
17		Transformer	See Electrical Group					
		Power Factor Choke	N/A	46-24256-04	N/A	46-24256-04	N/A	N/A
18		Control Board	See Electrical Group					
19		Blower Housing w/Wheel	70-101729-03	70-101729-04	70-101729-04	70-101729-04	70-101729-04	70-101729-04
	Stk	Blower Wheel	703013	703015	703015	703015	703015	703015
20		Motor Mount - Band	70-19927-04	70-19927-04	70-19927-04	70-19927-04	70-19927-04	70-19927-04
21		Motor Mount - Arm (4)	70-19929-10	70-19929-10	70-19929-10	70-19929-10	70-19929-10	70-19929-10
22	Stk	Blower Motor (X-13)	51-101920-01	51-102173-02	51-101920-02	51-102173-02	51-101920-02	51-103253-01
23		Mounting Bracket Cover	AE-101797-01	AE-101797-01	AE-101797-01	AE-101797-01	AE-101797-01	AE-101797-01

No.	Notes	MODEL	HFE	HFE	HFE	HFE	HFE	HFE
		CAPACITY	24	36	38	48	48	60
		CABINET SIZE	17	17	21	21	24	24
		VOLTAGE	0/1	0/1	0/1	0/1	0/1	0/1/4
<b>COIL GROUP</b>								
12		Replacement Coil w/TXV - Before Date Code Shown	RCSL-HM2417AU (4009)	RCSL-HM3617AU (0809)	RCSL-HU3821CU (N/A)	RCSL-HM4821AU (2309)	RCSL-HM4824AU (2309)	RCSL-HM6024AU (4109)
12		Replacement Coil w/TXV - After Date Code Shown	RCSL-HU2417CU (4009)	RCSL-HU3617CU (0809)	RCSL-HU3821CU (N/A)	RCSL-HU4821CU (2309)	RCSL-HU4824CU (2309)	RCSL-HU6024CU (4109)
		Horizontal Adapter Kit	RXHH-02	RXHH-03	RXHH-03	RXHH-04	RXHH-04	RXHH-05
		Drain Pan	See specified RCSL Coil Parts List					
		TXV	See specified RCSL Coil Parts List					

No.	Notes	MODEL	HFE	HFE	HFE	HFE	HFE	HFE
		CAPACITY	24	36	38	48	60	60
		CABINET SIZE	17	17	21	21/24	24	24
		VOLTAGE	0/1	0/1	0/1	0/1	0/1	4
<b>HEATER KITS</b>								
		Heater Kit - 3kW/208-240/1	RXBH-17A03J RXBH-1724A03J RXBH-1724B03J RXBH-1724C03J	RXBH-17A03J RXBH-1724A03J RXBH-1724B03J RXBH-1724C03J	N/A	N/A	N/A	N/A
		Heater Kit - 5kW/208-240/1	RXBH-17A05J RXBH-1724A05J RXBH-1724B05J RXBH-1724C05J	RXBH-17A05J RXBH-1724A05J RXBH-1724B05J RXBH-1724C05J	RXBH-24A05J RXBH-1724A05J RXBH-1724B05J RXBH-1724C05J	RXBH-24A05J RXBH-1724A05J RXBH-1724B05J RXBH-1724C05J	RXBH-24A05J RXBH-1724A05J RXBH-1724B05J RXBH-1724C05J	N/A
		Heater Kit - 7kW/208-240/1	RXBH-17A07J RXBH-1724A07J RXBH-1724B07J RXBH-1724C07J	RXBH-17A07J RXBH-1724A07J RXBH-1724B07J RXBH-1724C07J	RXBH-24A07J RXBH-1724A07J RXBH-1724B07J RXBH-1724C07J	RXBH-24A07J RXBH-1724A07J RXBH-1724B07J RXBH-1724C07J	RXBH-24A07J RXBH-1724A07J RXBH-1724B07J RXBH-1724C07J	RXBH-24A07D
		Heater Kit - 10kW/208-240/1	RXBH-17A10J RXBH-1724A10J RXBH-1724B10J RXBH-1724C10J	RXBH-17A10J RXBH-1724A10J RXBH-1724B10J RXBH-1724C10J	RXBH-24A10J RXBH-1724A10J RXBH-1724B10J RXBH-1724C10J	RXBH-24A10J RXBH-1724A10J RXBH-1724B10J RXBH-1724C10J	RXBH-24A10J RXBH-1724A10J RXBH-1724B10J RXBH-1724C10J	RXBH-24A10D
		Heater Kit - 13kW/208-240/1	RXBH-17A13J RXBH-1724A13J	RXBH-17A13J RXBH-1724A13J	N/A	N/A	N/A	N/A
		Heater Kit - 15kW/208-240/1	N/A	RXBH-17A15J RXBH-1724A15J	RXBH-24A15J RXBH-1724A15J	RXBH-24A15J RXBH-1724A15J	RXBH-24A15J RXBH-1724A15J	RXBH-24A15D
		Heater Kit - 18kW/208-240/1	N/A	RXBH-17A18J RXBH-1724A18J	RXBH-24A18J RXBH-1724A18J	RXBH-24A18J RXBH-1724A18J	RXBH-24A18J RXBH-1724A18J	RXBH-24A18D
		Heater Kit - 20kW/208-240/1	N/A	N/A	RXBH-24A20J	RXBH-24A20J	RXBH-24A20J	RXBH-24A20D
		Heater Kit - 25kW/208-240/1	N/A	N/A	RXBH-24A25J	RXBH-24A25J	RXBH-24A25J	RXBH-24A25D
		Heater Kit - 30kW/208-240/1	N/A	N/A	RXBH-24A30J	RXBH-24A30J	RXBH-24A30J	RXBH-24A30D
		Heater Kit - 7kW/208-240/3	RXBH-17A07C RXBH-1724A07C	RXBH-17A07C RXBH-1724A07C	RXBH-24A07C RXBH-1724A07C	RXBH-24A07C RXBH-1724A07C	RXBH-24A07C RXBH-1724A07C	N/A
		Heater Kit - 10kW/208-240/3	RXBH-17A10C RXBH-1724A10C	RXBH-17A10C RXBH-1724A10C	RXBH-24A10C RXBH-1724A10C	RXBH-24A10C RXBH-1724A10C	RXBH-24A10C RXBH-1724A10C	N/A
		Heater Kit - 13kW/208-240/3	RXBH-17A13C RXBH-1724A13C	RXBH-17A13C RXBH-1724A13C	N/A	N/A	N/A	N/A
		Heater Kit - 15kW/208-240/3	N/A	RXBH-17A15C RXBH-1724A15C	RXBH-24A15C RXBH-1724A15C	RXBH-24A15C RXBH-1724A15C	RXBH-24A15C RXBH-1724A15C	N/A
		Heater Kit - 18kW/208-240/3	N/A	RXBH-17A18C RXBH-1724A18C	RXBH-24A18C RXBH-1724A18C	RXBH-24A18C RXBH-1724A18C	RXBH-24A18C RXBH-1724A18C	N/A
		Heater Kit - 20kW/208-240/3	N/A	N/A	RXBH-24A20C	RXBH-24A20C	RXBH-24A20C	N/A
		Heater Kit - 25kW/208-240/3	N/A	N/A	RXBH-24A25C	RXBH-24A25C	RXBH-24A25C	N/A
		Heater Kit - 30kW/208-240/3	N/A	N/A	N/A	RXBH-24A30C	RXBH-24A30C	N/A

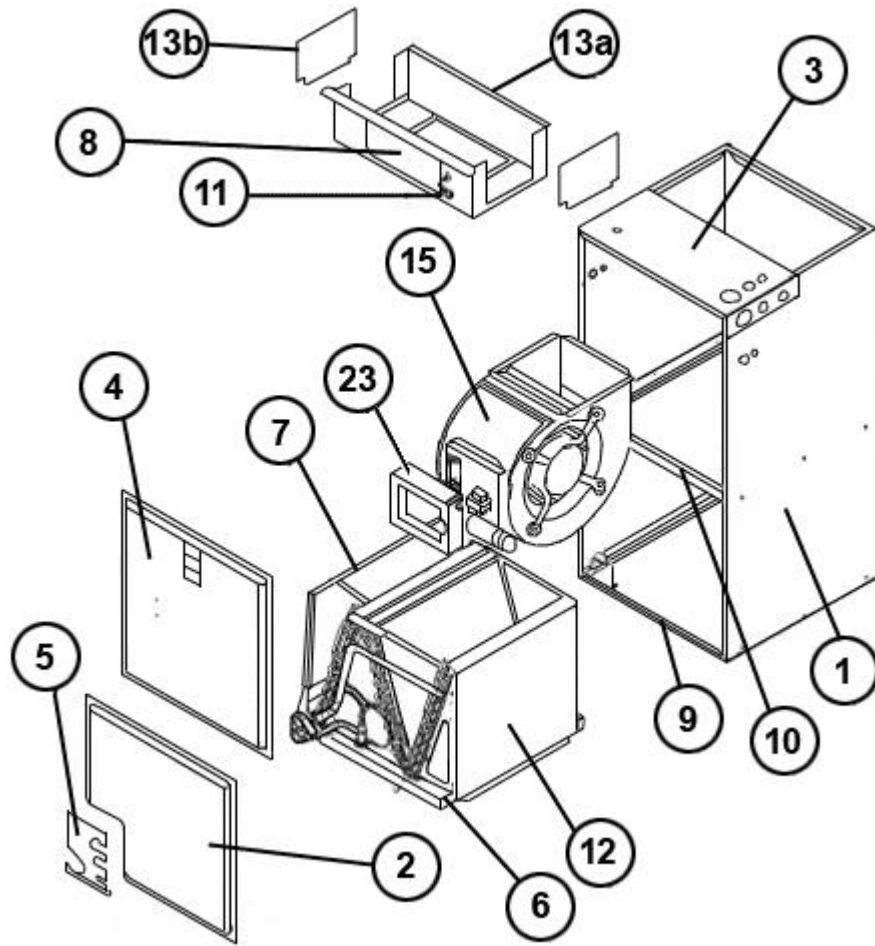

Exploded View



Blower Assembly

# NOTES

Stk It is recommended that stock be maintained for this part.  
N/A Not Applicable