

This Owner's Manual is provided and hosted by [Appliance Factory Parts](http://www.appliancefactoryparts.com).



# FRIEDRICH MWM18Y3J Owner's Manual

[Shop genuine replacement parts for FRIEDRICH  
MWM18Y3J](#)



[Find Your FRIEDRICH Other Parts - Select From 56 Models](#)

----- Manual continues below part list -----

## Available Replacement Parts for FRIEDRICH MWM18Y3J

<a href="#">P69700326</a>	Cross Flow Fan
<a href="#">P69700335</a>	Filter Sub Assembly
<a href="#">P69700328</a>	Step Motor
<a href="#">P69700323</a>	Fan Motor
<a href="#">P69700321</a>	Front Case Assembly
<a href="#">P69700313</a>	Remote Controller



F R I E D R I C H

# Service Manual

---

Models: MWM18Y3J/MRM18Y3J

MWM24Y3J/MRM24Y3J

(Refrigerant: R410A)

## Table of Contents

<b>Part I : Technical Information</b> .....	1
<b>1. Summary</b> .....	1
<b>2. Specifications</b> .....	2
2.1 Specification Sheet.....	2
2.2 Operation Characteristic Curve .....	4
2.3 Capacity Variation Ratio According to Temperature .....	5
2.4 Cooling and Heating Data Sheet in Rated Frequency .....	5
2.5 Noise Curve.....	6
<b>3. Outline Dimension Diagram</b> .....	7
3.1 Indoor Unit.....	7
3.2 Outdoor Unit.....	8
<b>4. Refrigerant System Diagram</b> .....	9
<b>5. Electrical Part</b> .....	10
5.1 Wiring Diagram.....	10
5.2 PCB Printed Diagram .....	13
<b>6. Function and Control</b> .....	16
6.1 Remote Controller Introduction .....	16
6.2 Brief Description of Modes and Functions.....	19
<b>Part II : Installation and Maintenance</b> .....	24
<b>7. Notes for Installation and Maintenance</b> .....	24
<b>8. Installation</b> .....	26
8.1 Installation Dimension Diagram.....	26
8.2 Installation Parts-checking .....	28
8.3 Selection of Installation Location.....	28
8.4 Electric Connection Requirement .....	28
8.5 Installation of Indoor Unit.....	28
8.6 Installation of Outdoor Unit.....	31
8.7 Vacuum Pumping and Leak Detection .....	32
8.8 Check after Installation and Test Operation .....	32

<b>9. Maintenance</b> .....	33
9.1 Error Code List .....	33
9.2 How to Check Simply the Main Part .....	37
9.3 Troubleshooting for Normal Malfunction .....	52
<b>10. Exploded View and Parts List</b> .....	54
10.1 Indoor Unit .....	54
10.2 Outdoor Unit .....	57
<b>11. Removal Procedure</b> .....	61
11.1 Removal Procedure of Indoor Unit .....	61
11.2 Removal Procedure of Outdoor Unit .....	67
<b>Appendix:</b> .....	73
Appendix 1: Reference Sheet of Celsius and Fahrenheit .....	73
Appendix 2: Configuration of Connection Pipe .....	73
Appendix 3: Pipe Expanding Method .....	74
Appendix 4: List of Resistance for Temperature Sensor .....	75



## 2. Specifications

### 2.1 Specification Sheet

Model			MWM18Y3J MRM18Y3J	MWM24Y3J MRM24Y3J	
Product Code			CB146032301_L13396	CB146032101_L13396	
Power Supply	Rated Voltage	V~	208/230	208/230	
	Rated Frequency	Hz	60	60	
	Phases		1	1	
Power Supply Mode			Outdoor	Outdoor	
Cooling Capacity (Min~Max)		Btu/h	18000(4500~21000)	22000(6400~24000)	
Heating Capacity (Min~Max)		Btu/h	19200(4000~23000)	24200(4100~26600)	
Cooling Power Input (Min~Max)		W	1700(200~2600)	2200(300~2550)	
Heating Power Input (Min~Max)		W	2400(300~2600)	2800(320~2800)	
Cooling Current Input		A	8.3/7.5	11.5/10.5	
Heating Current Input		A	11.77/10.65	13.0/12.8	
Rated Input		W	2600	2800	
Rated Current		A	11.8/10.9	13.0/12.8	
Air Flow Volume (SH/H/M/L/SL)		CMF	471/400/330/371/-	589/441/306/206/-	
Dehumidifying Volume		Pint/h	3.80	5.00	
EER		(Btu/h)/W	10.59	10.0	
COP		(Btu/h)/W	8.0	9.5	
SEER			16	16	
HSPF			8.5	9.5	
Application Area		yd <sup>2</sup>	20.07-28.43	32.3-50.2	
Indoor Unit	Indoor Unit Model		MWM18Y3J	MWM24Y3J	
	Indoor Unit Product Code		CB146N32300_L13396	CB146N32101_L13396	
	Fan Type		Cross-flow	Cross-flow	
	Fan Diameter Length (DXL)		inch	Φ3 6/7X25 3/5	Φ3 6/7X30 1/8
	Cooling Speed (SH/H/M/L/SL)		r/min	1400/1150/1000/850/-	1350/1150/1000/850/-
	Heating Speed (SH/H/M/L/SL)		r/min	1450/1250/1100/950/-	1350/1150/1000/900/-
	Fan Motor Power Output		W	20	35
	Fan Motor RLA		A	0.32	0.45
	Fan Motor Capacitor		μF	1.5	2.5
	Evaporator Form			Aluminum Fin-copper Tube	Aluminum Fin-copper Tube
	Evaporator Pipe Diameter		inch	Φ2/7	Φ2/7
	Evaporator Row-fin Gap		inch	2-1/18	2-1/17
	Evaporator Coil Length (LXDXW)		inch	25 6/7X1X12	30 1/8X1X13 1/2
	Swing Motor Model			MP28VB	MP35XX
	Swing Motor Power Output		W	2	2.5
	Fuse Current		A	3.15	3.15
	Sound Pressure Level (SH/H/M/L/SL)		dB (A)	48/43/38/34/-	49/43/39/34/-
	Sound Power Level (SH/H/M/L/SL)		dB (A)	58/53/48/44/-	59/53/49/44/-
	Dimension (WXHXD)		inch	34 1/7X12X8 1/2	39 5/7X12 5/9X8 2/3
	Dimension of Carton Box (LXWXH)		inch	37 1/5X14 9/10X11 3/5	42 1/4X15 5/9X12 1/3
Dimension of Package (LXWXH)		inch	37 1/3X15X12 1/5	42 1/3X15 2/3X13	
Net Weight		lb	26	33	
Gross Weight		lb	33	39	

Outdoor Unit	Outdoor Unit Model		MRM18Y3J	MRM24Y3J
	Outdoor Unit Product Code		CB146W17401_L13396	CB146W0141_L13396
	Compressor Manufacturer		MITSUBISHI ELECTRIC (GUANGZHOU)COMPRESSOR CO. LTD	China Resources (Shenyang) Sanyo CO.,LTD
	Compressor Model		SNB130FGYMC	C-6RZ146H1A
	Compressor Oil		FV50S	FV50S
	Compressor Type		Rotary	Rotary
	Compressor LRA.	A	/	/
	Compressor RLA	A	10.86	12.5
	Compressor Power Input	W	1245	1630
	Compressor Overload Protector		1NT11L-6578	1NT11L-3979
	Throttling Method		Capillary	Electron expansion valve
	Set Temperature Range	°F	61~86	61~86
	Cooling Operation Ambient Temperature Range	°F	5~115	5~115
	Heating Operation Ambient Temperature Range	°F	5~75	5~75
	Condenser Form		Aluminum Fin-copper Tube	Aluminum Fin-copper Tube
	Condenser Pipe Diameter	inch	Φ2/7	Φ2/7
	Condenser Rows-fin Gap	inch	2-1/18	2-1/18
	Condenser Coil Length (LXD <sub>X</sub> W)	inch	32 3/5X1 1/2X26	33 4/7X1 1/2X26
	Fan Motor Speed	rpm	690	690
	Fan Motor Power Output	W	60	60
	Fan Motor RLA	A	0.62	0.62
	Fan Motor Capacitor	μF	3.5	3.5
	Outdoor Unit Air Flow Volume	CFM	1883	1883
	Fan Type		Axial-flow	Axial-flow
	Fan Diameter	inch	Φ20 1/2	Φ20 1/2
	Defrosting Method		Automatic Defrosting	Automatic Defrosting
	Climate Type		T1	T1
	Isolation		I	I
	Moisture Protection		IP24	IP24
	Design Pressure(High)	PSIG	550	550
	Design Pressure(Low)	PSIG	240	240
	Sound Pressure Level (H/M/L)	dB(A)	56/-/-	53/-/-
	Sound Power Level (H/M/L)	dB(A)	66/-/-	63/-/-
Dimension (WXHXD)	inch	38X27 5/9X15 3/5	38X27 5/9X15 3/5	
Dimension of Carton Box (LXWXH)	inch	40 2/5X18X29	40 2/5X18X29	
Dimension of Package (LXWXH)	inch	40 1/2X18 1/32X29 1/2	40 1/2X18 1/32X29 1/2	
Net Weight	lb	106	115	
Gross Weight	lb	117	126	
Refrigerant		R410A	R410A	
Refrigerant Charge	oz	45.86	54.67	
Connection Pipe	Connection Pipe Length	ft	24.6	24.6
	Connection Pipe Gas Additional Charge	oz/ft.	0.2	0.2
	Outer Diameter Liquid Pipe	inch	Φ1/4	Φ1/4
	Outer Diameter Gas Pipe	inch	Φ1/2	Φ1/2
	Max Distance Height	ft	32.8	32 4/5
	Max Distance Length	ft	82.0	82.0
Note: The connection pipe applies metric diameter.				

The above data is subject to change without notice. Please refer to the nameplate of the unit.

## 2.2 Operation Characteristic Curve

MWM18Y3J/MRM18Y3J

Cooling

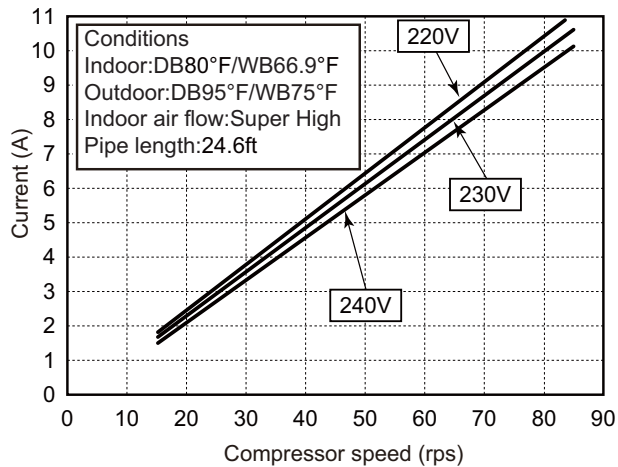

Heating

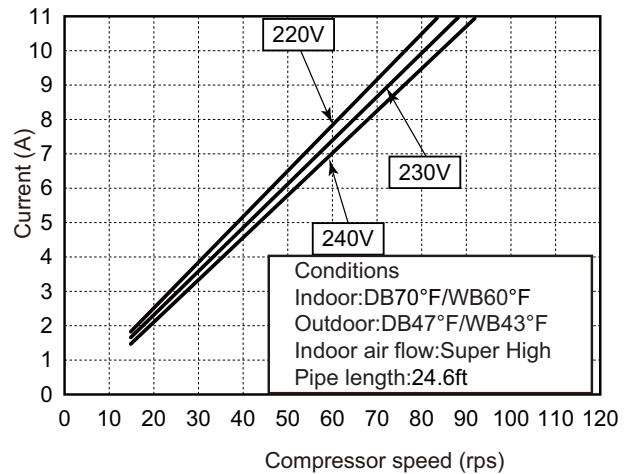

MWM24Y3J/MRM24Y3J

Cooling

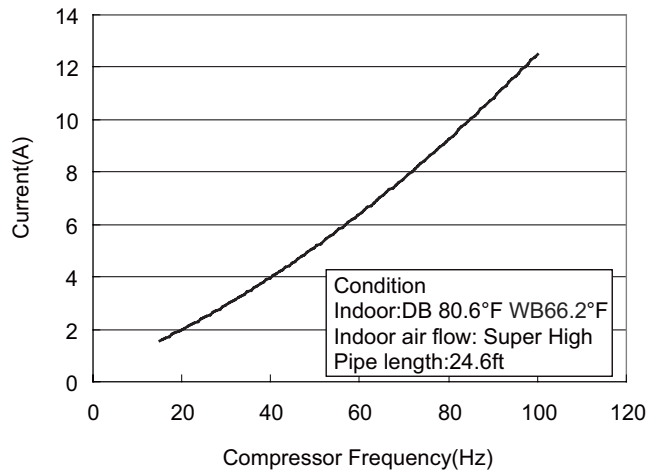

Heating

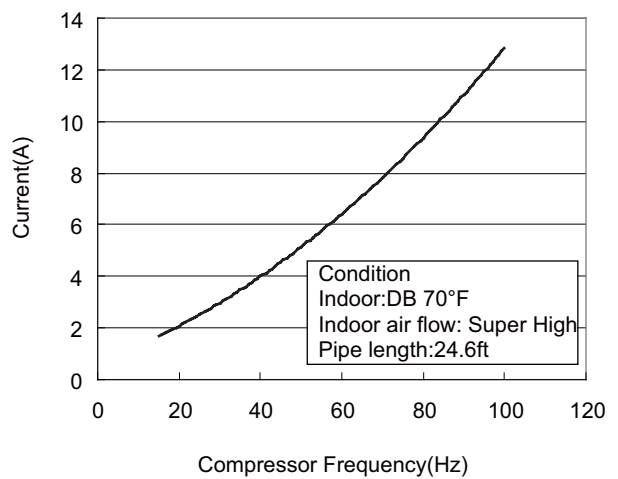

### 2.3 Capacity Variation Ratio According to Temperature

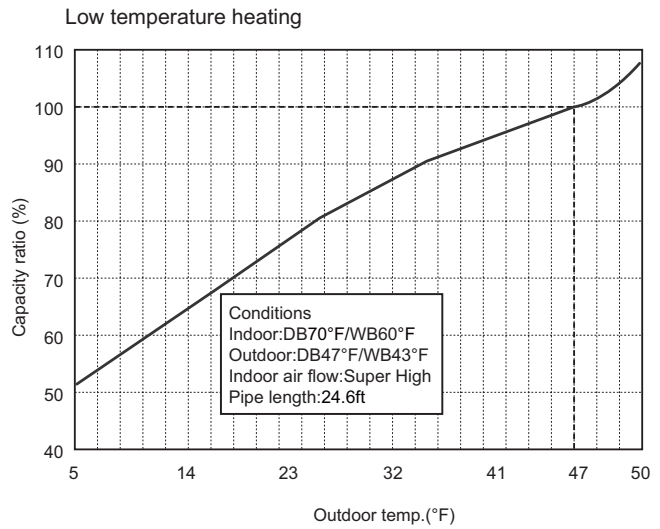
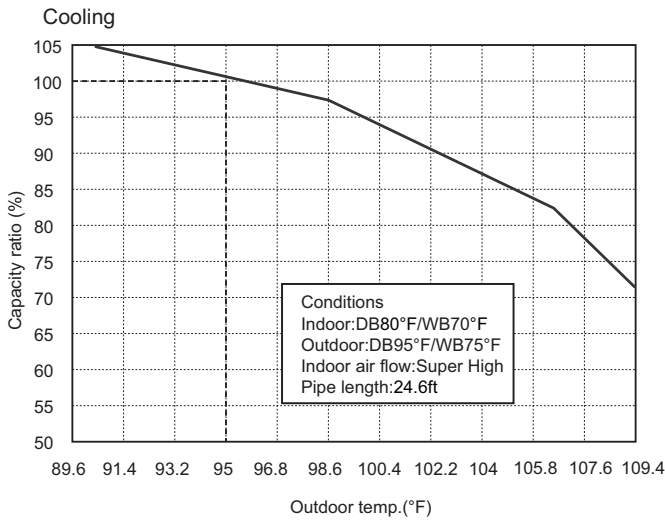

### 2.4 Cooling and Heating Data Sheet in Rated Frequency

Cooling:

Rated cooling condition(°F) (DB/WB)		Model	Pressure of gas pipe connecting indoor and outdoor unit	Inlet and outlet pipe temperature of heat exchanger		Fan speed of indoor unit	Fan speed of outdoor unit	Compressor frequency (Hz)
Indoor	Outdoor			T1 (°F)	T2 (°F)			
80/67	95/75	MWM18Y3J MRM18Y3J	0.9 to 1.1	54 to 57	176 to 104	Super High	High	75
80/67	95/75	MWM24Y3J MRM24Y3J	0.9 to 1.1	54 to 57	176 to 104	Super High	High	89

Heating:

Rated heating condition(°F) (DB/WB)		Model	Pressure of gas pipe connecting indoor and outdoor unit	Inlet and outlet pipe temperature of heat exchanger		Fan speed of indoor unit	Fan speed of outdoor unit	Compressor frequency (Hz)
Indoor	Outdoor			T1 (°F)	T2 (°F)			
70/60	47/43	MWM18Y3J MRM18Y3J	2.5 to 2.7	158 to 104	34 to 41	Super High	High	90
70/60	47/43	MWM24Y3J MRM24Y3J	2.5 to 2.7	158 to 104	34 to 41	Super High	High	87

**Instruction:**

T1: Inlet and outlet pipe temperature of evaporator

T2: Inlet and outlet pipe temperature of condenser

P: Pressure at the side of big valve

Connection pipe length: 24.6 ft.

## 2.5 Noise Curve

Indoor side noise when blowing

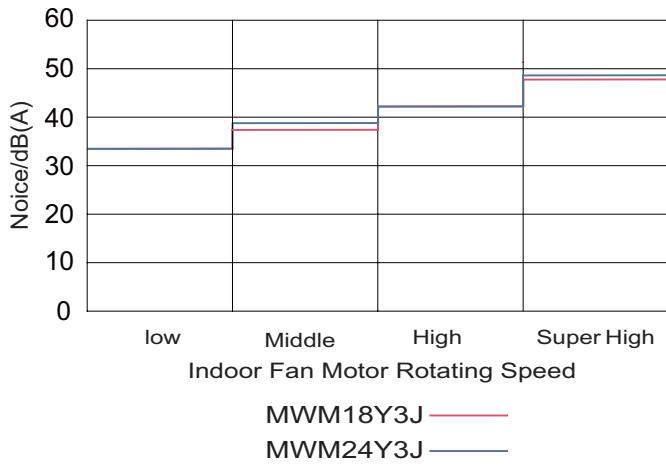

Outdoor side noise when blowing

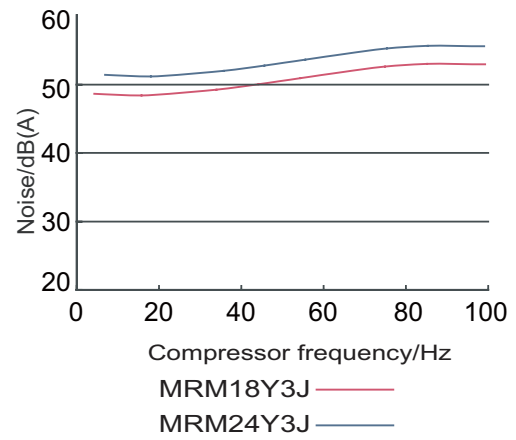



### 3.2 Outdoor Unit

MRM18Y3J MRM24Y3J

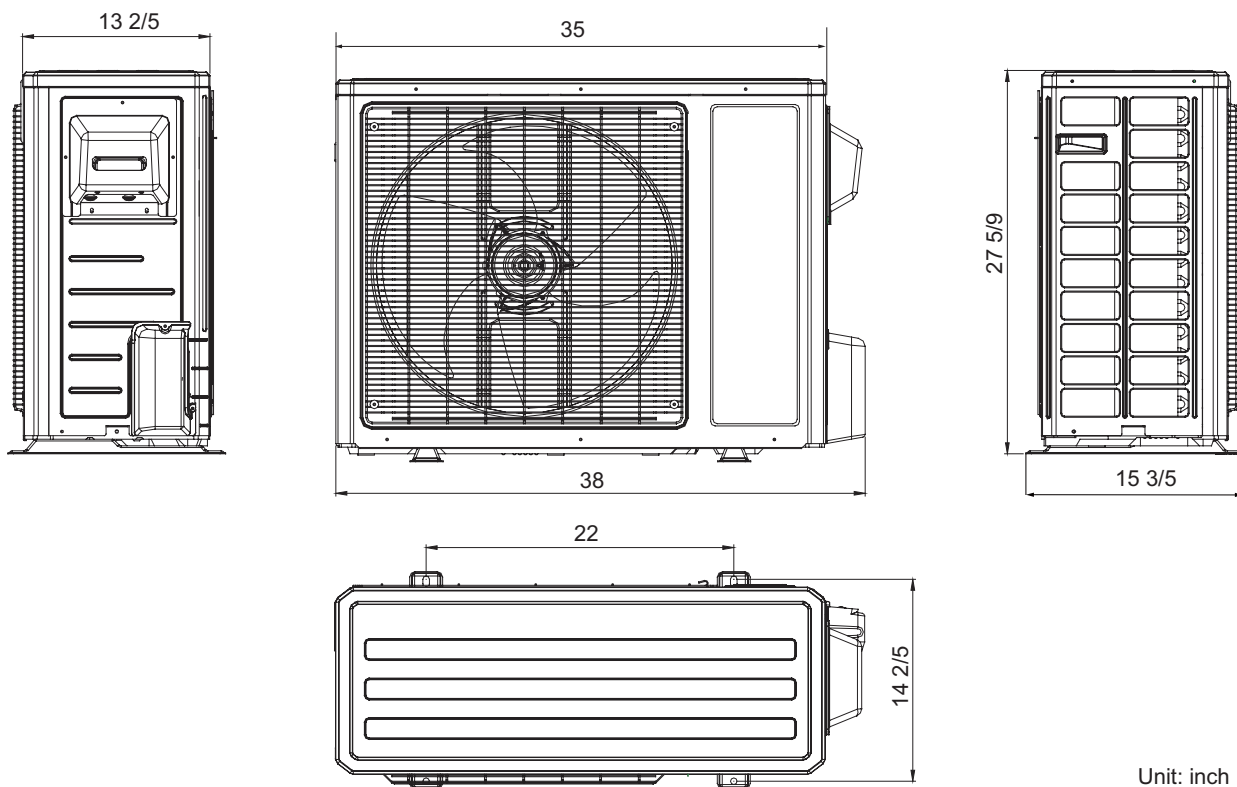

Unit: inch





MWM24Y3J

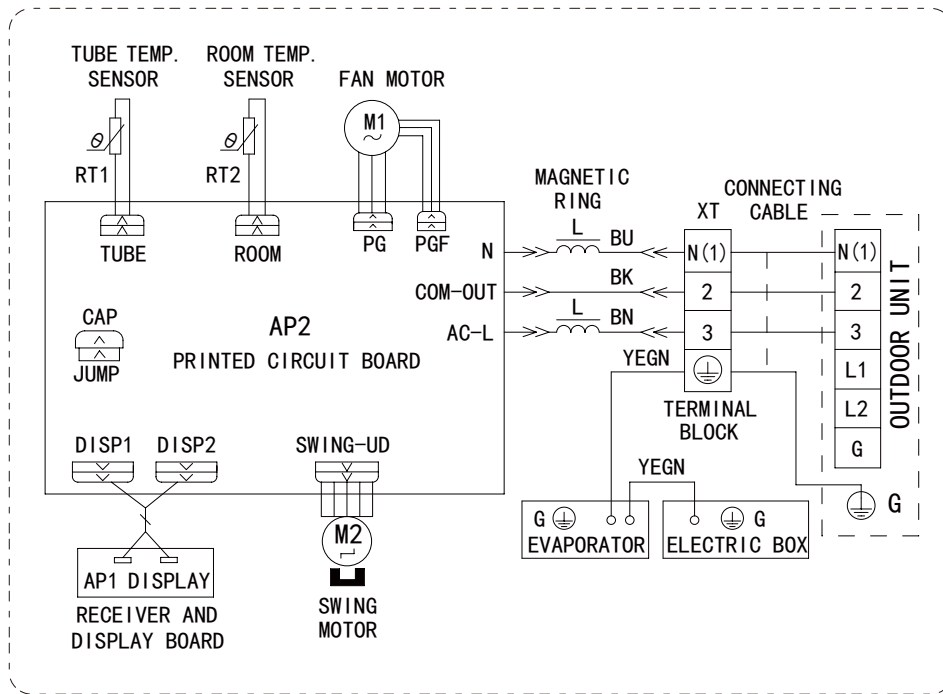

• Outdoor Unit

MRM18Y3J

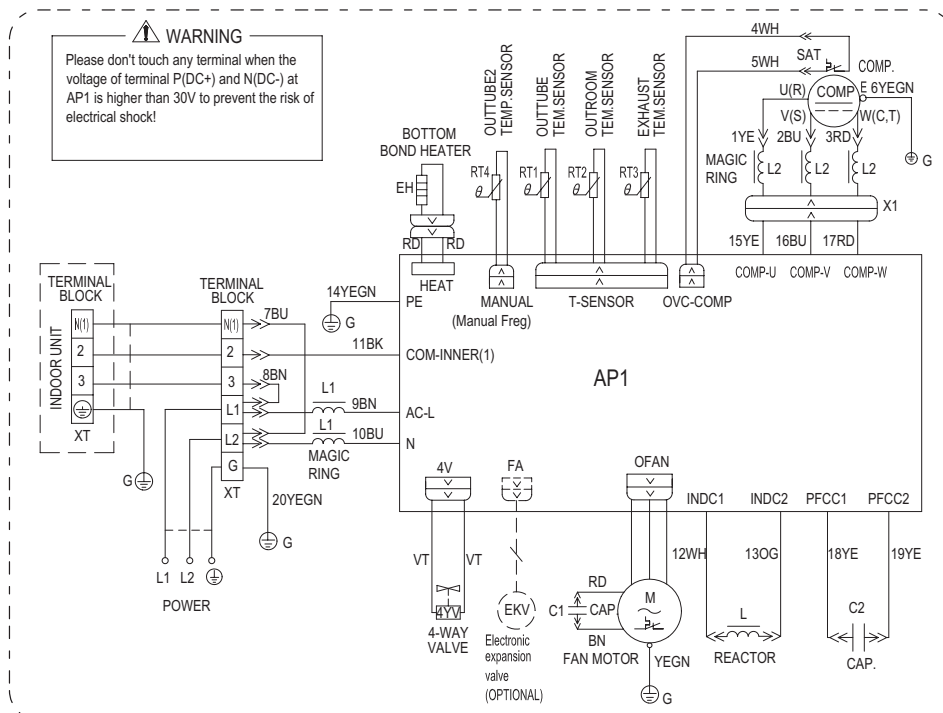

MRM24Y3J

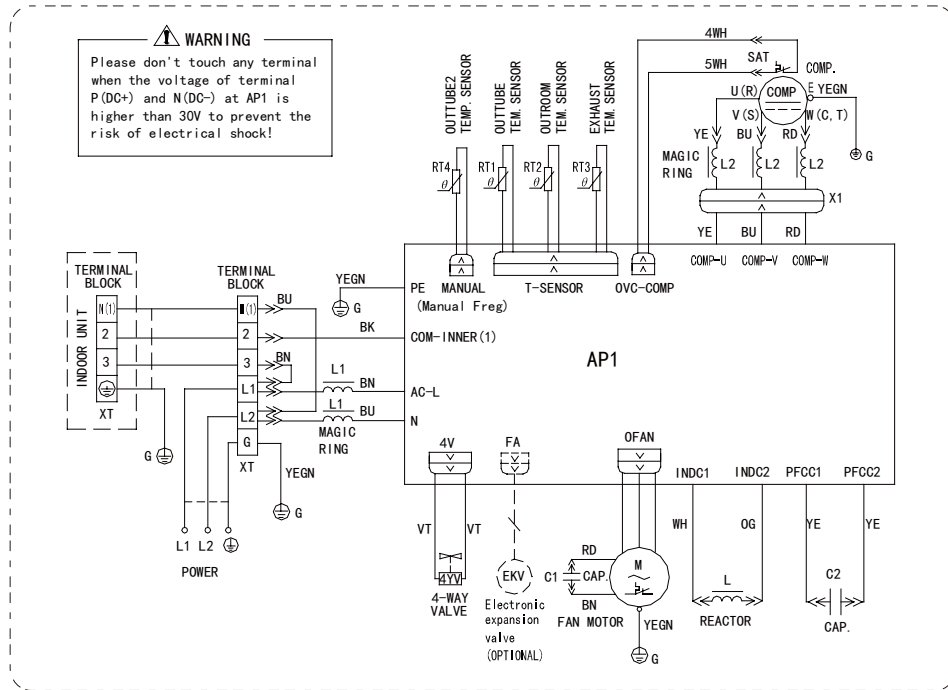

These circuit diagrams are subject to change without notice, please refer to the one supplied with the unit.

## 5.2 PCB Printed Diagram

### Indoor Unit

MWM18Y3J

#### • Top view

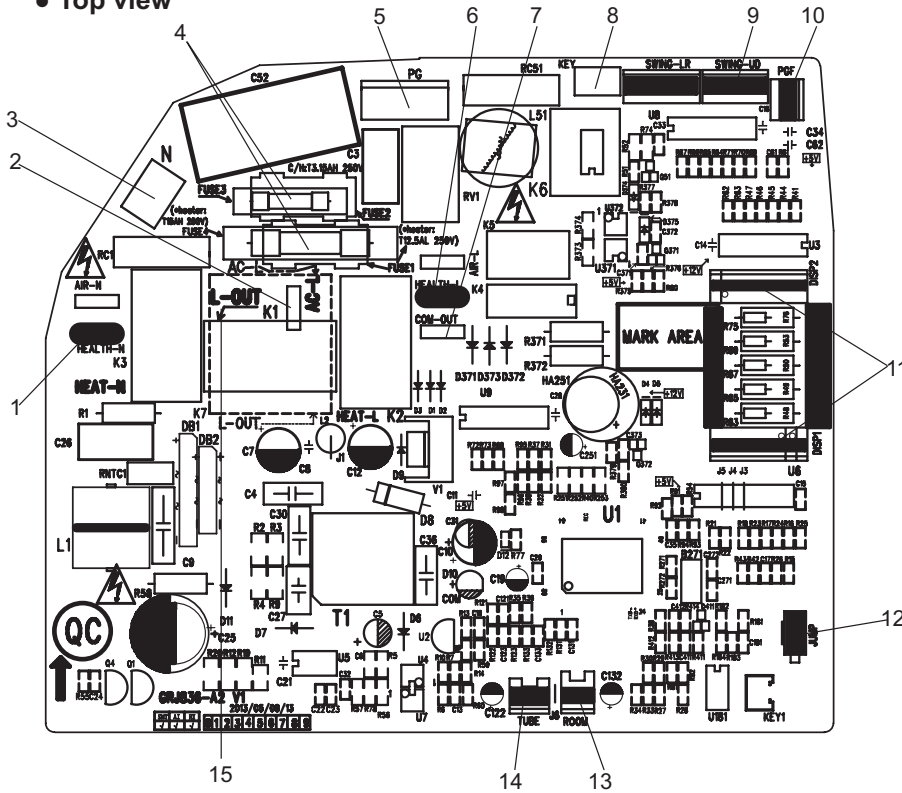

1	Neutral Wire of Health Function
2	Live Wire
3	Neutral Wire
4	Fuse
5	PG motor
6	Live Wire of Health Function
7	Communication terminal between indoor and outdoor units
8	Auto switch
9	Up&down swing
10	PG Feedback
11	Display Interface
12	Jumper cap
13	Ambient Temperature Sensor
14	Tube Temperature Sensor
15	Interface of outdoor live

#### • Bottom view

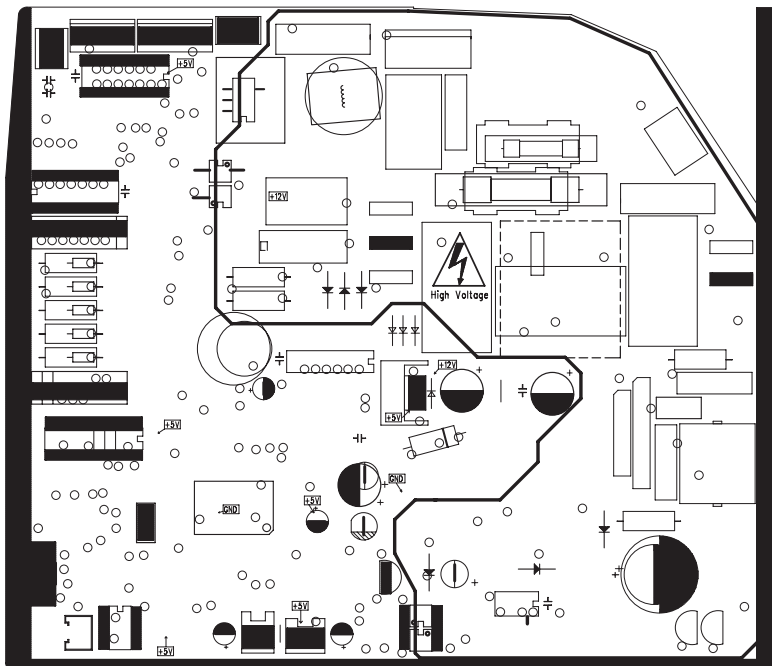





## 6. Function and Control

### 6.1 Remote Controller Introduction

#### Buttons on Remote Controller



#### Introduction for Icons on Display Screen

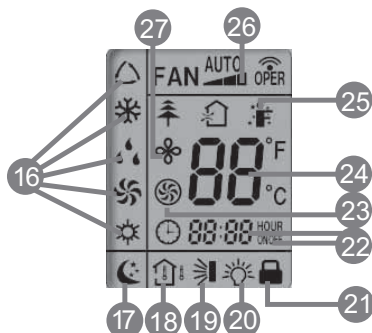

- 1 START / STOP: Press to start or stop operation.
- 2 ▼ : Press to decrease temperature setting.
- 3 ▲ : Press to increase temperature setting.
- 4 FAN AUTO: Press to set fan speed.
- 5 MODE: Press to select operation mode (AUTO/COOL/DRY/FAN/HEAT).
- 6 SENSOR
- 7 CLOCK: Press it set clock.
- 8 TIMER ON: Press it to set auto-on timer.
- 9 AIR SWEEP: Press it set swing angle.
- 10 EXTEND
- 11 TEMP
- 12 TIMER OFF: Press it to set auto-off timer.
- 13 TURBO
- 14 SLEEP
- 15 LIGHT: Press it to turn on/off the light.
- 16 MODE icon: If MODE button is pressed, current operation mode icon △ (AUTO), ❄️ (COOL), 💧 (DRY), 🌀 (FAN) or ☀️ (HEAT) (only for heat pump models) will show.
- 17 SLEEP icon : 🌙 is displayed by pressing the SLEEP button. Press this button again to clear the display.
- 18 TEMP icon: Pressing TEMP button, 🏠 (set temperature), 🏠 (indoor ambient temperature), 🏠 (outdoor ambient temperature) and blank is displayed circularly.
- 19 AIR SWEEP icon: 🌀 is displayed when pressing the AIR SWEEP button. Press this button again to clear the display.
- 20 LIGHT icon: 💡 is displayed by pressing the LIGHT button. Press LIGHT button again to clear the display.
- 21 LOCK icon: 🗝️ is displayed by pressing “▼” and “▲” buttons simultaneously. Press them again to clear the display.
- 22 SET TIME display: After pressing TIMER button, ON or OFF will blink. This area will show the set time.
- 23 TURBO icon: 🌀 is displayed when pressing the TURBO button. Press this button again to clear the display.
- 24 DIGITAL display: This area will show the set temperature.
- 25 SENSOR icon: 🏠 is displayed when pressing the SENSOR button. Press this button again to clear the display.
- 26 FAN SPEED display: Press FAN button to select the desired fan speed setting (AUTO-Low-Med-High). Your selection will be displayed in the LCD windows, except the AUTO fan speed.
- 27 EXTEND icon: 🌀 is displayed when pressing the EXTEND button. Press this button again to clear the display.





**13. TURBO button**

Press this button to activate / deactivate the Turbo function which enables the unit to reach the preset temperature in the shortest time. In COOL mode, the unit will blow strong cooling air at super high fan speed. In HEAT mode, the unit will blow strong heating air at super high fan speed. (This function is not applicable for some models).



**14. SLEEP button**

Press this button to go into the SLEEP operation mode. Press it again to cancel this function. This function is available in COOL or DRY mode to maintain the most comfortable temperature for you.

**15. LIGHT button**

Press LIGHT button to turn on the display's light and press this button again to turn off the display's light. If the light is turned on,  is displayed. If the light is turned off,  disappears.

**Combination of "▲" and "▼" buttons: About lock**

Press "▲" and "▼" buttons simultaneously to lock or unlock the keypad. If the remote controller is locked,  is displayed. In this case, pressing any button,  blinks three times.

**Combination of "MODE" and "-" buttons:**

Allows you to toggle between Fahrenheit and Celsius. When the unit is OFF, press "MODE" and "▼" buttons simultaneously to switch between °C and °F.

**Replacement of Batteries in Remote Controller**

1. Press the back side of remote controller marked with  as shown in the fig, and then push out the cover of battery box along the arrow direction.
2. Replace two 7# (AAA 1.5V) dry batteries, and make sure the position of "+" polar and "-" polar are correct.
3. Reinstall the cover of battery box.

**Note:**

- During operation, point the remote control signal sender at the receiving window on indoor unit.
- The distance between signal sender and receiving window should be no more than 8m, and there should be no obstacles between them.
- Signal may be interfered easily in the room where there is fluorescent lamp or wireless telephone; remote controller should be close to indoor unit during operation.
- Replace new batteries of the same model when replacement is required.
- When you don't use remote controller for a long time, please take out the batteries.
- If the display on remote controller is fuzzy or there's no display, please replace batteries.

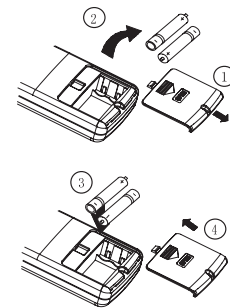

Sketch map for replacing batteries

## 6.2 Brief Description of Modes and Functions

### Indoor Unit

#### Temperature Parameter

- ◆ Room setting temperature ( $T_{\text{preset}}$ )
- ◆ Room ambient temperature ( $T_{\text{amb}}$ ) (temperature sensor :15K, partial pressure resistance:15K)
- ◆ Surface temperature of copper pipe for indoor heat exchanger ( $T_{\text{indoor tube}}$ ) (temperature sensor: 20K, partial pressure resistance: 20K)

#### 1. Basic Functions of System

##### (1) Cooling Mode

1. In this mode, indoor fan and swing will operate according to the setting status. The temperature setting range is 61~86°C.
2. When the unit stop operation due to malfunction of outdoor unit or protection, indoor unit will keep original operating status. Malfunction code will be displayed.
3. When  $0^{\circ}\text{F} \leq (T_{\text{preset}} - T_{\text{amb}})$ , if the indoor unit is operating at high fan speed, the speed of fan will change to medium fan speed; if the indoor unit is operating at medium or low fan speed, the speed of fan will keep the same; (This condition can only be carried out after the compressor is started up);  
Theres no change for super-high fan speed; when  $(T_{\text{amb}} - T_{\text{preset}}) \geq 1.8^{\circ}\text{F}$ , the fan speed will resume setting fan speed;

##### (2) Dry Mode

1. In this mode, fan will operate at low fan speed and swing will operate at setting status. The temperature setting range is 61~86°F.
2. When the unit stop operation due to malfunction of outdoor unit or protection, indoor unit will keep original operating status. Malfunction code will be displayed.

##### (3) Fan Mode

1. In this mode, indoor fan will operate at high, medium, low or auto fan speed. Compressor, indoor fan and the four-way valve will all stop operation.
2. In this mode, the temperature setting range is 61~86°F.

##### (4) Heating Mode

1. In this mode, the temperature setting range is 61~86°F.
2. Working condition and process of heating: when the unit is turned on in heating mode, indoor unit enters into anti-cold air condition; when the unit is tuned off, the unit will enter into the condition of blowing residual heat.
3. Protection function: in heating mode, when the compressor is stopped due to malfunction, indoor fan will operate at the condition of blowing residual heat.
4. Defrosting control: after receiving the defrosting signal from outdoor unit, the defrosting code H1 will be displayed.
5. Anti-cold function
6. Blowing residual heat function;
  - a. During heating operation, when the stopping condition for the compressor is reached, the compressor and the outdoor fan motor stop operation. The upper& down horizontal louver will rotate to the horizontal position L. The indoor fan will be stopped after operating for 60s at setting speed.
  - b. Due to the blockage of PG motor, horizontal louver will keep the stop position when the unit is turned off. (In other modes) When the unit is stopped due to other malfunctions, up&down horizontal louver will rotate to horizontal position L. The indoor fan will be stopped after operating for 60s at setting speed.
  - c. If the unit is turned off when the compressor is operating in heating mode or auto heating mode, up&down horizontal louver will rotate to horizontal position L. The indoor fan will be stopped after operating for 60s at setting speed.

##### (5) Auto Mode

1. When  $T_{\text{amb}} \geq 78.8^{\circ}\text{F}$ , the unit will operate in cooling mode. The implied setting temperature is 77°F.
2. Heat pump type: when  $T_{\text{amb}} \leq 71.6^{\circ}\text{F}$ , the unit will operate in heating mode. The implied setting temperature is 68°F.
3. Cooling only unit: when  $T_{\text{amb}} \leq 77^{\circ}\text{F}$ , the unit will operate in auto mode. The implied setting temperature is 77°F.
4. When  $73.4^{\circ}\text{F} \leq T_{\text{indoor amb}} \leq 77^{\circ}\text{F}$ , the unit will operate in auto fan mode if the unit is turned on and enters into the auto mode for the first time. If the unit is switched to auto mode from other mode, it will keep the previous operation mode (if the unit is switched to auto mode from dry mode, the unit will operate at auto fan mode).

#### 2. Display Status of Indoor Indicator

##### (1) Status of Indoor Display Board

1. After energization, all the icons will be displayed and then only the power indicator is bright. When the unit is turned on by remote controller, the operation indicator will be bright. Meanwhile, the current setting operation mode will be displayed.
2. During defrosting, "dual-8" will display "H".
3. "Dual-8" displays setting temperature.

##### ➤ Display of Operation Icon and Mode Icon

After energization, all the icons will be displayed for once. In standby status, the operation indicator will be in red. If turn on the unit by remote controller, the operating indication icon will be bright. Meanwhile, the current setting operation mode will be displayed (mode indicator: cooling indicator, heating indicator, dry indicator). If turn off the light button, all displays will be turned off.

##### ➤ Temperature display control mode for split type unit

1. When user set the remote controller as the setting temperature display status, the current setting temperature will be displayed on remote controller.
2. Only when the remote control signal is switched to indoor ambient temperature display status from other display status, controller will display the indoor ambient temperature for 5s and then turn back to display the setting temperature.
3. When user hasnt set the temperature displaying status, it will be displayed according to the setting temperature.

##### (2) Malfunction Display of Indoor Unit

When multiple malfunctions occurred simultaneously, malfunction protection codes will be displayed in cycle.

### 3. Other Control Target

#### (1) Up&down swing function: the mode for swing motor is MP28VB.

After energization, up & down swing motor will firstly let the horizontal louver anticlockwise rotate to position 0 to close air outlet.

If swing function has not been set after startup of the unit, up & down horizontal louver will clockwise turn to position D in HEAT mode, or clockwise turn to level position L in other modes.

If setting swing function while starting up the unit, the horizontal louver will swing between L and D.

There are 7 kinds of swing status of horizontal louver: Positions L, A, B, C and D, swing between L and D and stop at any position between L and D.

Upon turning off the unit, the horizontal louver will close at position 0. Swing function is available only when swing function set and indoor fan is operating.

Note: If the position is set between L and B, A and C or B and D by remote controller, the horizontal louver will swing between L and D.

L----A----B----C----D

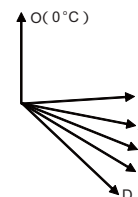

#### (2) Buzzer

Upon energization and operation, the buzzer will give out sound.

#### (3) Auto Button

After pressing this button, the unit will operate in auto mode. Indoor fan will operate at auto fan speed and swing motor will operate. Press this button again to turn off the unit. The complete unit is energized when pressing the button and the complete unit will enter into fast testing status. After energization, if its detected that the auto button is pressed down and the complete unit is at fast testing status, the fast testing status will be exited.

#### (4) Sleep Function

This mode is only valid in cooling and heating mode. The unit will select the appropriate sleeping curve to operate according to the different setting temperature.

##### During cooling mode:

(1) When the initial temperature is set as 60.8~73.4°F, after starting up the sleep function, the temperature will increase by 33.8°F every one hour.

After the temperature has increased by 37.4°F, the unit will keep this temperature. When the unit has operated for 7 hours, the temperature will decrease by 33.8°F and then the unit will operate at this temperature all the time;

(2) When the initial temperature is set as 75.2~80.6°F, after starting up the sleep function, the temperature will increase by 33.8°F every one hour.

After the temperature has increased by 35.6°F, the unit will keep this temperature. When the unit has operated for 7 hours, the temperature will decrease by 33.8°F and then the unit will operate at this temperature all the time;

(3) When the initial temperature is set as 82.4~84.2°F, after starting up the sleep function, the temperature will increase by 33.8°F every one hour.

After the temperature has increased by 33.8°F, the unit will keep this temperature. When the unit has operated for 7 hours, the temperature will decrease by 33.8°F and then the unit will operate at this temperature all the time;

(4) When the initial temperature is set as 86°F, the unit will operate at this temperature. After the unit has operate for 7hours, the temperature will decrease by 33.8°F and then the unit will operate at this temperature all the time.

##### During Heating Mode:

(1) When the initial temperature is set at 61°F, the unit will operate at this temperature all the time;

(2)When the initial temperature is set as 17~20°F, after starting up the sleep function, the temperature will decrease by 33.8°F every one hour.

After the temperature is decreased by 33.8°F, the unit will operate at this temperature;

(3)When the initial temperature is set as 62.6~80.6°F, after starting up the sleep function, the temperature will decrease by 33.8°F every one hour.

After the temperature is decreased by 35.6°F, the unit will operate at this temperature;

(4)When the initial temperature is set as 82.4~86°F, after starting up the sleep function, the temperature will decrease by 33.8°F every one hour.

After the temperature is decreased by 37.4°F, the unit will operate at this temperature;

General timer and clock timer functions are compatible by equipping different functions of remote controller.

#### (5) Timer Function

General timer and clock timer functions are compatible by equipping different functions of remote controller.

##### General timer:

###### Timer ON

If timer ON is set during operation of the unit, the unit will continue to operate. If timer ON is set at unit OFF, upon ON time reaches the unit will start to operate according to previous setting status.

###### Timer OFF

If timer OFF is set at unit OFF, the system will keep standby status. If timer OFF is set at unit ON, upon OFF time reaches the unit will stop operation.

### **(6) Blow Function**

Blow function can be set in cooling and dry mode.

### **(7) Indoor Fan Control**

Indoor fan can be set at super-high, high, medium or low. Meanwhile, the fan will operate at super-high, high, medium and low fan speed respectively and it can also set at auto fan speed.

### **(8) Memory Function**

Memory content includes mode, up & down swing, light, set temperature and set fan speed, general timer (clock timer cant be memorized), Upon power failure, the unit after power recovery will automatically start operation according to memorized content. The unit, without timer setting before power failure, will operate according to the last setting after power recovery. The unit, with general timer setting which has not been fulfilled before power failure, will memorize the time setting and re-calculate the time after power recovery. If there is timer function in the last remote controller command but setting time has reached, the system will act as timer on/off setting before power failure. After power failure, the system memorizes the operation states before power failure without timer action. Clock timer can not be memorized.

### **(9) Locked protection to PG motor**

If the indoor fan motors rotational speed after startup keeps slow for a continuous period of time, the unit will stop operation and display "H6".

### **(10) Turbo Function**

This function can be set in cooling or heating mode to quickly cool or heat the room(Turbo function is not available in auto, dry and fan mode). After pressing the turbo button, indoor fan will operate at super-high fan speed.

## **5. Malfunction Detection for Temperature sensor**

### **(1) Indoor ambient temperature sensor:**

Malfunction of temperature sensor will be detected at any time;

### **(2) Indoor tube temperature sensor**

Malfunction of temperature sensor wont be detected during defrosting period. It starts detecting the malfunction of temperature sensor after defrosting is finished for 5 mins. Malfunction of temperature sensor will be detected at any other time.

### **(3) Protection of temperature sensor**

1. When the temperature sensor is detected short circuit for 30s successively:

The detected temperature by the temperature sensor is too high and the complete unit will stop operation, meanwhile, the protection and malfunction of temperature sensor will be displayed accordingly.

2. When the temperature sensor is detected open circuit for 30s successively: The unit will stop operation due to protection and the corresponding malfunction of temperature sensor will be displayed directly.

## **6. Refrigerant Recovery Function (applicable when changing installation location or in maintenance)**

### **(1) Enter refrigerant recovery function**

Within 5min after energizing(unit ON or OFF status is ok),continuously press LIGHT button for 3 times within 3s to enter refrigerant recycling mode; Fo is displayed and refrigerant recycling function is started. At this moment, the maintenance people closs liquid valve. After 5min, stick the thimble of maintenance valve with a tool. If there is no refrigerant spraying out, close the gas valve immediately and then turn off the unit to remove the connection pipe.

### **(2) Exit refrigerant recovery function**

After entering refrigerant recycling mode, when receive any remote control signal or enter refrigerant recycling mode for 25min, the unit will exit refrigerant recycling mode automatically if the unit is in standby mode before refrigerant recycling, it will be still in standby mode after finishing refrigerant recycling; if the unit is in ON status before refrigerant recycling, it will still run in original operation mode.

## **7. Compulsory Defrosting Function**

### **(1) Start up compulsory defrosting function**

Under ON status, set heating mode with remote controller and adjust the temperature to 61°F. Press "+, -, +, -, +,-" button successively within 5s and the complete unit will enter into compulsory defrosting status. Meanwhile, the defrosting code H1 will be displayed. (Note: If complete unit has malfunction or stops operation due to protection, compulsory defrosting function can be started up after malfunction or protection is resumed.

### **(2) Exit compulsory defrosting mode**

After compulsory defrosting is started up, the complete unit will exit defrosting operation according to the actual defrosting result, and the complete unit will resume normal heating operation.

## **Outdoor Unit**

### **1. Input Parameter Compensation and Calibration**

#### **(1) Check the input parameter compensation function**

As the instruction feature of split unit, concerning the comfortable, in heating mode, the indoor ambient temperature of compressor stopping time is higher than preset temperature.

#### **(2) Check effective judgment controls of parameters**

Effective judgment function of the outdoor exhaust temperature thermo-bulb

When conditions a and b are satisfied, the outdoor exhaust temperature thermo-bulb is judged not to be connected into place, the

mainboard of outer units will display failure of the outdoor exhaust temperature thermo-bulb (not connected into place), stop the unit for repairing, and resume it by remote controls of ON/OFF.

## 2. Basic Functions

### (1) Cooling Mode

#### 1. Conditions and processes of cooling operation:

- (1) If the compressor is stop, and  $[T_{\text{preset}} - (T_{\text{indoor ambient}} - \Delta T_{\text{cooling indoor ambient temperature compensation}})] \leq 1^{\circ}\text{F}$ , start up the unit for cooling, and start to cooling operation;
- (2) During operations of cooling, if  $0^{\circ}\text{F} \leq [T_{\text{preset}} - (T_{\text{indoor ambient}} - \Delta T_{\text{cooling indoor ambient temperature compensation}})] < 3.6^{\circ}\text{F}$ , the cooling operation will be still running;
- (3) During operations of cooling, if  $0^{\circ}\text{F} \leq [T_{\text{preset}} - (T_{\text{indoor ambient}} - \Delta T_{\text{cooling indoor ambient temperature compensation}})]$ , the cooling operation will stop after reaching to the temperature point.

#### 2. Temperature setting range

- (1) If  $T_{\text{outdoor ambient}} \geq [T_{\text{low-temperature cooling}}]$ , the temperature can be set at: 61~86°F (Cooling at room temperature);
- (2) If  $T_{\text{outdoor ambient}} < [T_{\text{low-temperature cooling}}]$ , the temperature can be set at: 77~86°F (Cooling at low temperature), that is, the minimum setting temperature for outdoor unit judgment is 77°F.

### (2) Dry Mode

1. Conditions and processes of dry operations: Same as the cooling mode;
2. The temperature setting range is: 61~86°F;

### (3) Fan Mode

1. The compressor, outdoor fan and four-way valve are switched off;
2. The temperature setting range is: 61~86°F.

### (4) Heating Mode

1. Conditions and processes of heating operations: ( $T_{\text{indoor ambient}}$  is the actual detection temperature of indoor environment thermo-bulb,  $\Delta T_{\text{heating indoor ambient temperature compensation}}$  is the indoor ambient temperature compensation during heating operations)

- (1) If the compressor is stop, and  $[(T_{\text{indoor ambient}} - \Delta T_{\text{heating indoor ambient temperature compensation}}) - T_{\text{preset}}] \leq 1^{\circ}\text{F}$ , start the machine to enter into heating operations for heating;
- (2) During operations of heating, if  $0^{\circ}\text{F} \leq [(T_{\text{indoor ambient}} - \Delta T_{\text{heating indoor ambient temperature compensation}}) - T_{\text{preset}}] < 3.6^{\circ}\text{F}$ , the heating operation will be still running;
- (3) During operations of heating, if  $3.6^{\circ}\text{F} \leq [(T_{\text{indoor ambient}} - \Delta T_{\text{heating indoor ambient temperature compensation}}) - T_{\text{preset}}]$ , the heating operation will stop after reaching the temperature point.
2. The temperature setting range in this mode is: 61~86°F.

### (5) Defrosting Control

1. After the time for defrosting is judged to be satisfied, if the temperature for defrosting is satisfied after detections for continuous 3minutes, the defrosting operation will start.
2. Start to defrost: Compressor stops and starts up 55S later;
3. Defrosting finish: Compressor stops and starts up 55S later;
4. Conditions of finishing defrosting

The defrosting operation can exit when any of the conditions below is satisfied:

- (1)  $T_{\text{outdoor pipe}} \geq 53.6^{\circ}\text{F}$ ;
- (2)  $T_{\text{outdoor ambient}} < 23^{\circ}\text{F}$ , and the  $T_{\text{outdoor pipe}} \geq 42.8^{\circ}\text{F}$  last more than 80S;
- (3) The continuous running time of defrosting reaches to 8min.

### (6) Compressor Control

1. The frequency of compressor will be controlled with the relationship of ambient temperature and preset temperature and changing speed of ambient temperature;
2. Start the compressor after starting cooling, heating, dry operations, and the outdoor fan start for 5s;
3. When the unit is off, in safety stops and switching to fan mode, the compressor will stop immediately;
4. In all modes: once the compressor starts up, it will not be allowed to stop until having run for the  $[T_{\text{min. Compressor running time}}]$  (Note: including cases of shutdown when the temperature point is reached; except the cases requiring stopping the compressor such as fault protection, remote shutdown, mode switching etc.);
5. In all modes: once the compressor stops, it will be allowed be restart after 3-minute delay (Note: The indoor units have a function of power memory, the machine can be restarted after remote shutdown and powering up again without delay).

### (7) Outdoor Fan Control

1. When the unit is off by remote control, in safety stops and stop after reaching to the temperature point.
2. In fan mode: The outdoor fan stops;
3. Start to defrost: Outdoor fan will stop after compressor stops for 50S;
4. Defrosting finish: Outdoor fan will start up when the compressor is stopping.

#### (8) 4-way valve control

1. The 4-way valve control under the modes of Cooling, dehumidification and fan: closing;
2. When the unit is on in heating mode, the 4-way valve is energized;
3. When the unit is on in heating mode and heating mode shift to other modes, the 4-way valve will be de-energized after compressor stops for 2min;
4. After protection stops, the 4-way valve will be de-energized after 4min;
5. Start to defrost: The power of 4-way valve will be de-energized after the compressor stops;
6. Defrosting finish: The 4-way valve will be energized after the compressor stops.

#### (9) Current protection

1. If  $12A \leq I_{\text{alternating-current}}$  running frequency of compressor will be decreased or stop to increase will be occurred;
2. If  $17A \leq I_{\text{alternating-current}}$  the unit will stop; and compressor has stopped for 3min, the unit will resume running;
3. If the unit stops as compressor discharge temperature for 6 times, it can not resume running automatically and display malfunction, it can resume by pressing ON/OFF. During operation, if the time exceeds compressor running time, the time of compressor discharge temperature stop will zero clearing.

#### (10) Drop off voltage

During compressor operation, the system will stop and malfunction of drop off voltage if voltage downward fluctuates rapidly, and it will re-start up automatically 3min later.

#### (11) Communication malfunction

If the unit does not receive correct signal from indoor unit for 3min continuously, the unit will stop as communication malfunction protection; if communication malfunction resume and compressor has stopped for 3min, the unit will resume running.

#### (12) IPM module protection

When the compressor starts, if there is overcurrent or control voltage low for IPM module as some abnormal results, IPM will detect module protection signal as the unit is on. Once the module protective signal is detected, stop the unit with module protection immediately. If the module protection is resumed and compressor has stopped for 3min, the unit will be allowed to operate. If the module protection continuously occurs for three times, it should not be resumed automatically, and you should press the ON/OFF button to resume. If the running time of compressor exceeds the [ $t_{\text{Protection times clearing of module}}$ ], the module protection is cleared to recount.

#### (13) Compressor overload protection

1. If the switch of compressor overload de-energized is detected for 3S continuously, the system will stop as protection;
2. If the overload protection is resumed and compressor has stopped for 3min, the unit will be allowed to operate.
3. If the unit stops as compressor overload protection occurred for 3 times continuously, it can not resume running automatically and display malfunction, it can resume by pressing ON/OFF; and the times of compressor overload protection will be cleared after the compressor has run for 30min.

# Part II : Installation and Maintenance

## 7. Notes for Installation and Maintenance

### Safety Precautions: Important!

Please read the safety precautions carefully before installation and maintenance.

The following contents are very important for installation and maintenance.

Please follow the instructions below.

- The installation or maintenance must accord with the instructions.
- Comply with all national electrical codes and local electrical codes.
- Pay attention to the warnings and cautions in this manual.
- All installation and maintenance shall be performed by distributor or qualified person.
- All electric work must be performed by a licensed technician according to local regulations and the instructions given in this manual.
- Be caution during installation and maintenance. Prohibit incorrect operation to prevent electric shock, casualty and other accidents.



## Warnings

### Electrical Safety Precautions:

1. Cut off the power supply of air conditioner before checking and maintenance.
2. The air condition must apply specialized circuit and prohibit share the same circuit with other appliances.
3. The air conditioner should be installed in suitable location and ensure the power plug is touchable.
4. Make sure each wiring terminal is connected firmly during installation and maintenance.
5. Have the unit adequately grounded. The grounding wire can't be used for other purposes.
6. Must apply protective accessories such as protective boards, cable-cross loop and wire clip.
7. The live wire, neutral wire and grounding wire of power supply must be corresponding to the live wire, neutral wire and grounding wire of the air conditioner.
8. The power cord and power connection wires can't be pressed by hard objects.
9. If power cord or connection wire is broken, it must be replaced by a qualified person.

10. If the power cord or connection wire is not long enough, please get the specialized power cord or connection wire from the manufacture or distributor. Prohibit prolong the wire by yourself.

11. For the air conditioner without plug, an air switch must be installed in the circuit. The air switch should be all-pole parting and the contact parting distance should be more than 1/8inch.

12. Make sure all wires and pipes are connected properly and the valves are opened before energizing.

13. Check if there is electric leakage on the unit body. If yes, please eliminate the electric leakage.

14. Replace the fuse with a new one of the same specification if it is burnt down; don't replace it with a cooper wire or conducting wire.

15. If the unit is to be installed in a humid place, the circuit breaker must be installed.

### Installation Safety Precautions:

1. Select the installation location according to the requirement of this manual.(See the requirements in installation part)
2. Handle unit transportation with care; the unit should not be carried by only one person if it is more than 44.09lb.
3. When installing the indoor unit and outdoor unit, a sufficient fixing bolt must be installed; make sure the installation support is firm.
4. Ware safety belt if the height of working is above 78 5/7inch.
5. Use equipped components or appointed components during installation.
6. Make sure no foreign objects are left in the unit after finishing installation.

### Refrigerant Safety Precautions:

1. Avoid contact between refrigerant and fire as it generates poisonous gas; Prohibit prolong the connection pipe by welding.
2. Apply specified refrigerant only. Never have it mixed with any other refrigerant. Never have air remain in the refrigerant line as it may lead to rupture or other hazards.
3. Make sure no refrigerant gas is leaking out when installation is completed.
4. If there is refrigerant leakage, please take sufficient measure to minimize the density of refrigerant.
5. Never touch the refrigerant piping or compressor without wearing glove to avoid scald or frostbite.

Improper installation may lead to fire hazard, explosion, electric shock or injury.



## 8. Installation

### 8.1 Installation Dimension Diagram

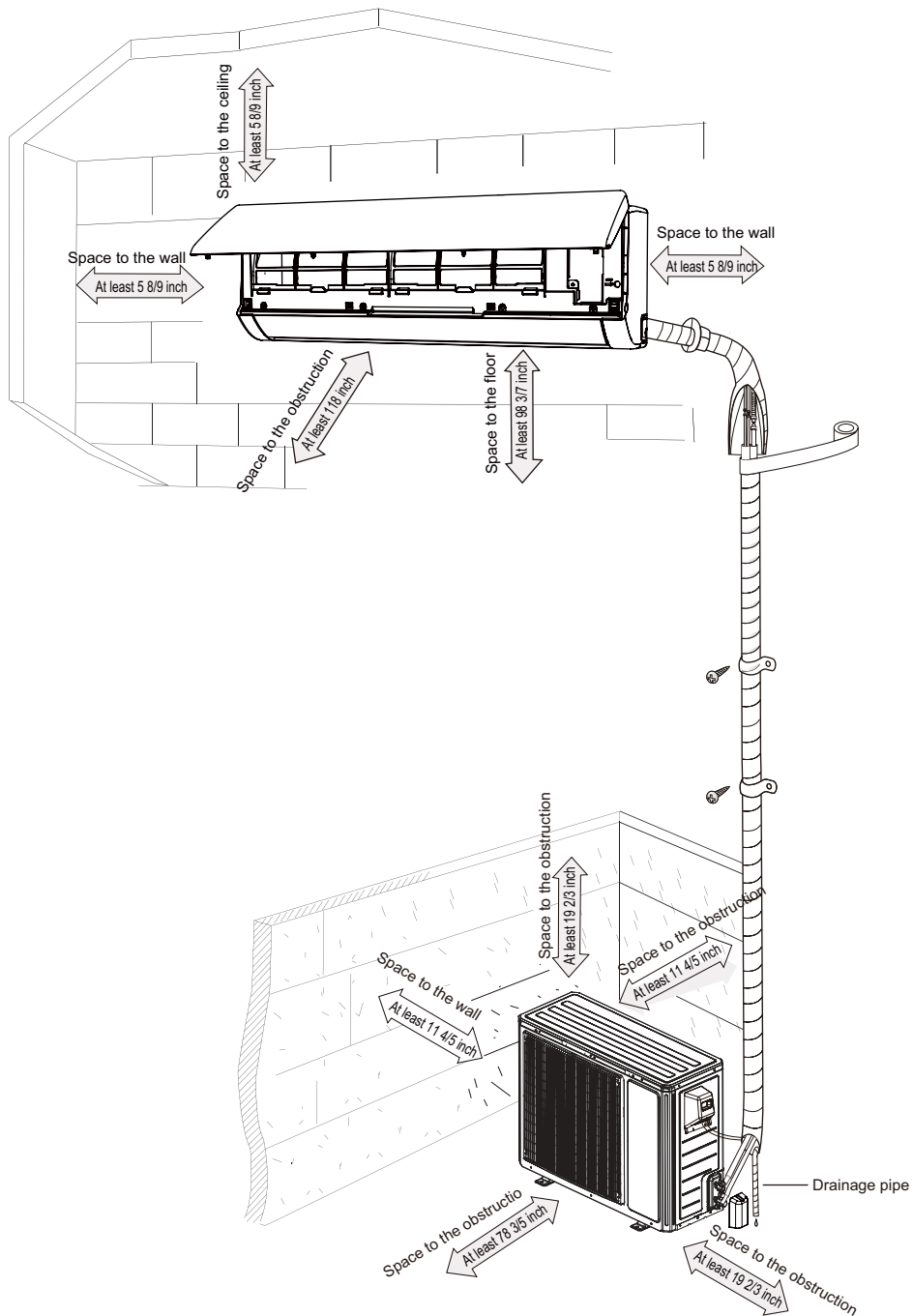



## 8.2 Installation Parts-checking

No.	Name	No.	Name
1	Indoor unit	8	Sealing gum
2	Outdoor unit	9	Wrapping tape
3	Connection pipe	10	Support of outdoor unit
4	Drainage pipe	11	Fixing screw
5	Wall-mounting frame	12	Drainage plug(cooling and heating unit)
6	Connecting cable(power cord)	13	Owner's manual, remote controller
7	Wall pipe		

### ⚠ Note:

1. Please contact the local agent for installation.
2. Don't use unqualified power cord.

## 8.3 Selection of Installation Location

### 1. Basic Requirement:

Installing the unit in the following places may cause malfunction. If it is unavoidable, please consult the local dealer:

- (1) The place with strong heat sources, vapors, flammable or explosive gas, or volatile objects spread in the air.
- (2) The place with high-frequency devices (such as welding machine, medical equipment).
- (3) The place near coast area.
- (4) The place with oil or fumes in the air.
- (5) The place with sulfureted gas.
- (6) Other places with special circumstances.

### 2. Indoor Unit:

- (1) There should be no obstruction near air inlet and air outlet.
- (2) Select a location where the condensation water can be dispersed easily and won't affect other people.
- (3) Select a location which is convenient to connect the outdoor unit and near the power socket.
- (4) Select a location which is out of reach for children.
- (5) The location should be able to withstand the weight of indoor unit and won't increase noise and vibration.
- (6) The appliance must be installed 98 3/7inch above floor.
- (7) Don't install the indoor unit right above the electric appliance.
- (8) The appliance shall not be installed in the laundry.

### 3. Outdoor Unit:

- (1) Select a location where the noise and outflow air emitted by the outdoor unit will not affect neighborhood.
- (2) The location should be well ventilated and dry, in which the outdoor unit won't be exposed directly to sunlight or strong wind.
- (3) The location should be able to withstand the weight of outdoor unit.
- (4) Make sure that the installation follows the requirement of installation dimension diagram.
- (5) Select a location which is out of reach for children and far away from animals or plants. If it is unavoidable, please add fence for safety purpose.

## 8.4 Electric Connection Requirement

### 1. Safety Precaution

- (1) Must follow the electric safety regulations when installing the unit.
- (2) According to the local safety regulations, use qualified power supply circuit and air switch.
- (3) Make sure the power supply matches with the requirement of air conditioner. Unstable power supply or incorrect wiring may result in electric shock, fire hazard or malfunction. Please install proper power supply cables before using the air conditioner.

Air-conditioner	Air switch capacity
MWM18Y3J/MRM18Y3J	25A
MWM24Y3J/MRM24Y3J	

- (4) Properly connect the live wire, neutral wire and grounding wire of power socket.
- (5) Be sure to cut off the power supply before proceeding any work related to electricity and safety.
- (6) Do not put through the power before finishing installation.
- (7) For appliances with type Y attachment, the instructions shall contain the substance of the following. If the supply cord is damaged, it must be replaced by the manufacturer, its service agent or similarly qualified persons in order to avoid a hazard.
- (8) The temperature of refrigerant circuit will be high, please keep the interconnection cable away from the copper tube.

### 2. Grounding Requirement:

- (1) The air conditioner is first class electric appliance. It must be properly grounded with specialized grounding device by a professional. Please make sure it is always grounded effectively, otherwise it may cause electric shock.
- (2) The yellow-green wire in air conditioner is grounding wire, which can't be used for other purposes.
- (3) The grounding resistance should comply with national electric safety regulations.
- (4) The appliance must be positioned so that the plug is accessible.
- (5) An all-pole disconnection switch having a contact separation of at least 1/8inch in all poles should be connected in fixed wiring.
- (6) Including an air switch with suitable capacity, please note the following table. Air switch should be included magnet buckle and heating buckle function, it can protect the circuit-short and overload. (Caution: please do not use the fuse only for protect the circuit)

## 8.5 Installation of Indoor Unit

### 1. Choosing Installation location

Recommend the installation location to the client and then confirm it with the client.

### 2. Install Wall-mounting Frame

- (1) Hang the wall-mounting frame on the wall; adjust it in horizontal position with the level meter and then point out the screw fixing holes on the wall.
- (2) Drill the screw fixing holes on the wall with impact drill (the specification of drill head should be the same as the plastic expansion particle) and then fill the plastic expansion particles

in the holes.

(3) Fix the wall-mounting frame on the wall with tapping screws (ST4.2X25TA) and then check if the frame is firmly installed by pulling the frame. If the plastic expansion particle is loose, please drill another fixing hole nearby.

### 3. Install Wall-mounting Frame

(1) Choose the position of piping hole according to the direction of outlet pipe. The position of piping hole should be a little lower than the wall-mounted frame.(As show in Fig.1)

MWM18Y3J

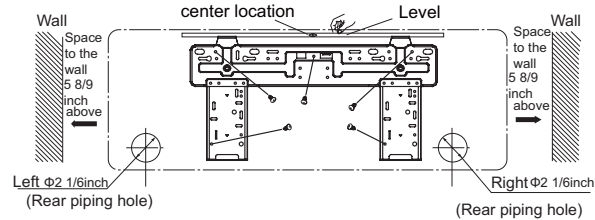

MWM24Y3J

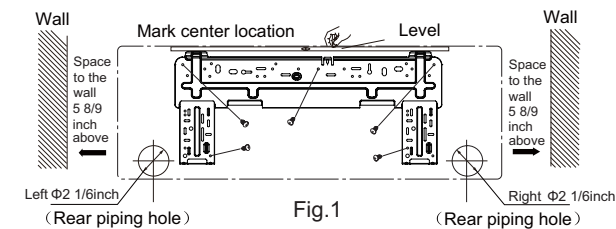

(2) Open a piping hole with the diameter of 2 1/6 inch on the selected outlet pipe position. In order to drain smoothly, slant the piping hole on the wall slightly downward to the outdoor side with the gradient of 5-10°. (As show in Fig.2)

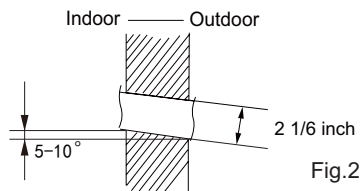

**Note:**

- (1) Pay attention to dust prevention and take relevant safety measures when opening the hole.
- (2) The plastic expansion particles are not provided and should be bought locally.

### 4. Outlet Pipe

(1) The pipe can be led out in the direction of right, rear right, left or rear left.(As show in Fig.3)  
 (2) When selecting leading out the pipe from left or right, please cut off the corresponding hole on the bottom case.(As show in Fig.4)

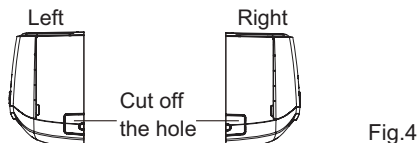
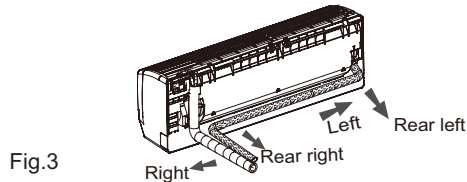

### 5. Connect the Pipe of Indoor Unit

- (1) Aim the pipe joint at the corresponding bellmouth.(As show in Fig.5)
- (2) Pretightening the union nut with hand.
- (3) Adjust the torque force by referring to the following sheet. Place the open-end wrench on the pipe joint and place the torque wrench on the union nut. Tighten the union nut with torque wrench.(As show in Fig.6)
- (4) Wrap the indoor pipe and joint of connection pipe with insulating pipe, and then wrap it with tape.(As show in Fig.7)

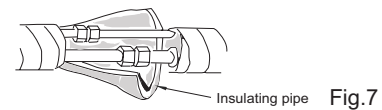
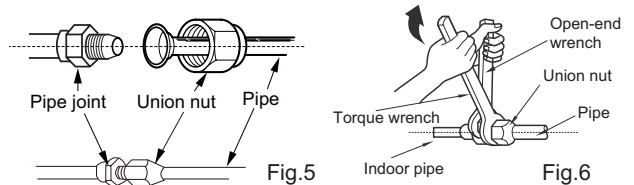

Refer to the following table for wrench moment of force :

Hex nut diameter(inch)	Tightening torque(ft-lbf)
Φ1/4	11~14.7
Φ3/8	22.8~29.5
Φ1/2	33.2~40.6
Φ5/8	44.3~47.9
Φ3/4	51.6~55.3

### 6. Install Drain Hose

- (1) Connect the drain hose to the outlet pipe of indoor unit.(As show in Fig.8)
- (2) Bind the joint with tape.(As show in Fig.9)

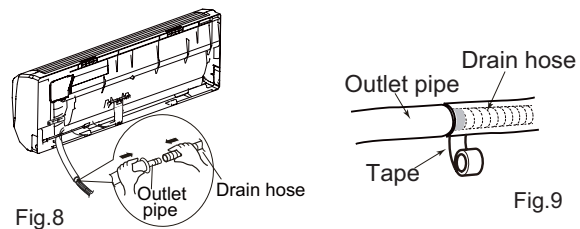

**Note:**

- (1) Add insulating pipe in the indoor drain hose in order to prevent condensation.
- (2) The plastic expansion particles are not provided. (As show in Fig.10)

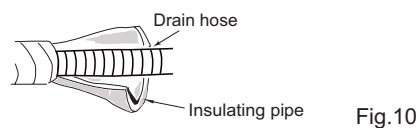

### 7. Connect Wire of Indoor Unit

(1) Open the panel, remove the screw on the wiring cover and then take down the cover.(As show in Fig.11)

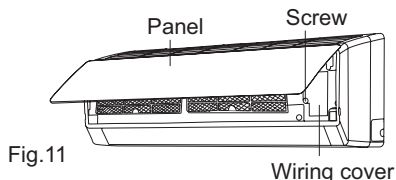

(2) Fix the wire crossing board on connection wire sleeve at the bottom case; let the connection wire sleeve go through the wire crossing hole at the back of indoor unit, and then pull it out from the front.(As show in Fig.12)

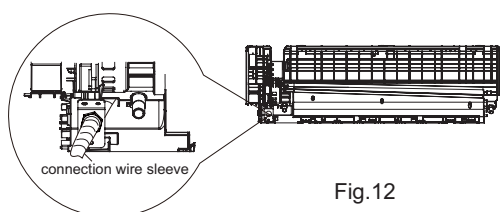

(3) Remove the wire clip; connect the power connection wire to the wiring terminal; tighten the screw and then fix the power connection wire with wire clip.(As show in Fig.13)

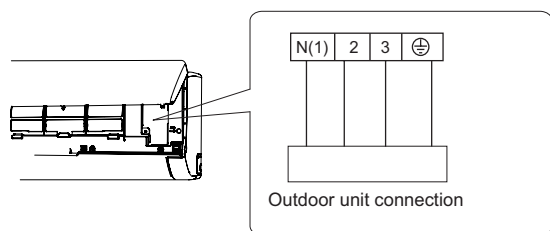

Fig.13

(4) Put wiring cover back and then tighten the screw.  
(5) Close the panel.

**⚠ Note:**

- (1) All wires of indoor unit and outdoor unit should be connected by a professional.
- (2) If the length of power connection wire is insufficient, please contact the supplier for a new one. Avoid extending the wire by yourself.
- (3) For the air conditioner with plug, the plug should be reachable after finishing installation.
- (4) For the air conditioner without plug, an air switch must be installed in the line. The air switch should be all-pole parting and the contact parting distance should be more than 1/8 inch.

### 8. Bind up Pipe

- (1) Bind up the connection pipe, power cord and drain hose with the band.(As show in Fig.14)
- (2) Reserve a certain length of drain hose and power cord for installation when binding them. When binding to a certain degree, separate the indoor power and then separate the drain hose.(As show in Fig.15)
- (3) Bind them evenly.
- (4) The liquid pipe and gas pipe should be bound separately at the end.

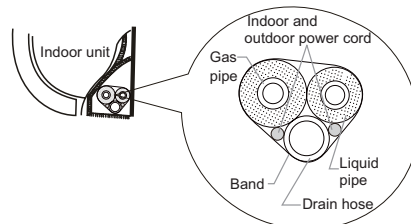

Fig.14

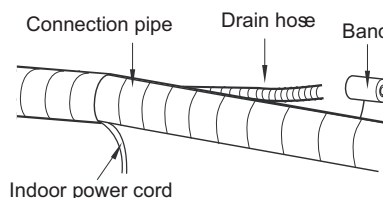

Fig.15

**⚠ Note:**

- (1) The power cord and control wire can't be crossed or winding.
- (2) The drain hose should be bound at the bottom.

### 9. Hang the Indoor Unit

- (1) Put the bound pipes in the wall pipe and then make them pass through the wall hole.
- (2) Hang the indoor unit on the wall-mounting frame.
- (3) Stuff the gap between pipes and wall hole with sealing gum.
- (4) Fix the wall pipe.(As show in Fig.16)
- (5) Check if the indoor unit is installed firmly and closed to the wall.(As show in Fig.17)

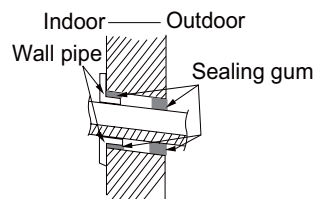
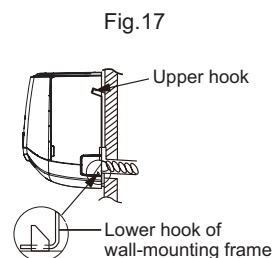

Fig.16



**⚠ Note:**

Do not bend the drain hose too excessively in order to prevent blocking.



**Note:**

- (1) The through-wall height of drain hose shouldn't be higher than the outlet pipe hole of indoor unit.(As show in Fig.25)
- (2) Slant the drain hose slightly downwards. The drain hose can't be curved, raised and fluctuant, etc.(As show in Fig.26)
- (3) The water outlet can't be placed in water in order to drain smoothly.(As show in Fig.27)

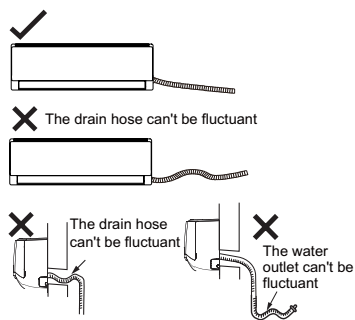

Fig.26

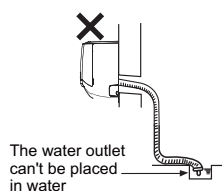

Fig.27

## 8.7 Vacuum Pumping and Leak Detection

### 1. Use Vacuum Pump

- (1) Remove the valve caps on the liquid valve and gas valve and the nut of refrigerant charging vent.
- (2) Connect the charging hose of piezometer to the refrigerant charging vent of gas valve and then connect the other charging hose to the vacuum pump.
- (3) Open the piezometer completely and operate for 10-15min to check if the pressure of piezometer remains in -0.1MPa.
- (4) Close the vacuum pump and maintain this status for 1-2min to check if the pressure of piezometer remains in -0.1MPa. If the pressure decreases, there may be leakage.
- (5) Remove the piezometer, open the valve core of liquid valve and gas valve completely with inner hexagon spanner.
- (6) Tighten the screw caps of valves and refrigerant charging vent.(As show in Fig.28)

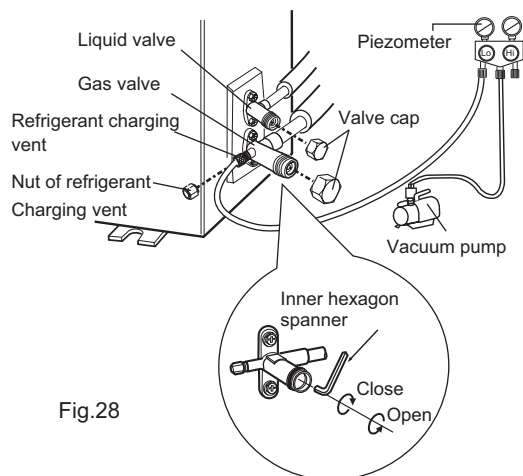

Fig.28

### 2. Leakage Detection

- (1) With leakage detector:  
Check if there is leakage with leakage detector.
- (2) With soap water:  
If leakage detector is not available, please use soap water for leakage detection. Apply soap water at the suspected position and keep the soap water for more than 3min. If there are air bubbles coming out of this position, there's a leakage.

## 8.8 Check after Installation and Test Operation

### 1. Check after Installation

Check according to the following requirement after finishing installation.

NO.	Items to be checked	Possible malfunction
1	Has the unit been installed firmly?	The unit may drop, shake or emit noise.
2	Have you done the refrigerant leakage test?	It may cause insufficient cooling (heating) capacity.
3	Is heat insulation of pipeline sufficient?	It may cause condensation and water dripping.
4	Is water drained well?	It may cause condensation and water dripping.
5	Is the voltage of power supply according to the voltage marked on the nameplate?	It may cause malfunction or damage the parts.
6	Is electric wiring and pipeline installed correctly?	It may cause malfunction or damage the parts.
7	Is the unit grounded securely?	It may cause electric leakage.
8	Does the power cord follow the specification?	It may cause malfunction or damage the parts.
9	Is there any obstruction in air inlet and air outlet?	It may cause insufficient cooling (heating).
10	The dust and sundries caused during installation are removed?	It may cause malfunction or damaging the parts.
11	The gas valve and liquid valve of connection pipe are open completely?	It may cause insufficient cooling (heating) capacity.

### 2. Test Operation

- (1) Preparation of test operation
  - The client approves the air conditioner installation.
  - Specify the important notes for air conditioner to the client.
- (2) Method of test operation
  - Put through the power, press ON/OFF button on the remote controller to start operation.
  - Press MODE button to select AUTO, COOL, DRY, FAN and HEAT to check whether the operation is normal or not.
  - If the ambient temperature is lower than 60.8°F, the air conditioner can't start cooling.

# 9. Maintenance

## 9.1 Error Code List

No.	Malfunction Name	Display Method of Indoor Unit			Display Method of Outdoor Unit (Indicator has 3 kinds of display status and they will be displayed circularly every 5s.)				A/C status	Possible Reasons	
		Dual-8 Code Display	Indicator Display (during blinking, ON 0.5s and OFF 0.5s)			<input type="checkbox"/> OFF <input checked="" type="checkbox"/> Illuminated <input checked="" type="checkbox"/> Blink					
			Operation Indicator	Cool Indicator	Heating Indicator	D5 (D40)	D6 (D41)	D16 (D42)			D30 (D43)
1	High pressure protection of system	E1	OFF 3s and blink once			<input type="checkbox"/>	<input checked="" type="checkbox"/>	<input checked="" type="checkbox"/>	<input checked="" type="checkbox"/>	During cooling and drying operation, except indoor fan operates, all loads stop operation. During heating operation, the complete unit stops.	Possible reasons: 1. Refrigerant was superabundant; 2. Poor heat exchange (including filth blockage of heat exchanger and bad radiating environment ); Ambient temperature is too high.
2	Antifreezing protection	E2	OFF 3S and blink twice			<input checked="" type="checkbox"/>	<input type="checkbox"/>	<input checked="" type="checkbox"/>	<input type="checkbox"/>	During cooling and drying operation, compressor and outdoor fan stop while indoor fan operates.	1. Poor air-return in indoor unit; 2. Fan speed is abnormal; 3. Evaporator is dirty.
3	High discharge temperature protection of compressor	E4	OFF 3S and blink 4 times			<input checked="" type="checkbox"/>	<input type="checkbox"/>	<input checked="" type="checkbox"/>	<input checked="" type="checkbox"/>	During cooling and drying operation, compressor and outdoor fan stop while indoor fan operates. During heating operation, all loads stop.	Please refer to the malfunction analysis (discharge protection, overload).
4	Overcurrent protection	E5	OFF 3S and blink 5 times			<input type="checkbox"/>	<input checked="" type="checkbox"/>	<input checked="" type="checkbox"/>	<input type="checkbox"/>	During cooling and drying operation, compressor and outdoor fan stop while indoor fan operates. During heating operation, all loads stop.	1. Supply voltage is unstable; 2. Supply voltage is too low and load is too high; 3. Evaporator is dirty.
5	Communication Malfunction	E6	OFF 3S and blink 6 times			<input type="checkbox"/>	<input type="checkbox"/>	<input type="checkbox"/>	<input checked="" type="checkbox"/>	During cooling operation, compressor stops while indoor fan motor operates. During heating operation, the complete unit stops.	Refer to the corresponding malfunction analysis.
6	High temperature resistant protection	E8	OFF 3S and blink 8 times			<input checked="" type="checkbox"/>	<input type="checkbox"/>	<input checked="" type="checkbox"/>	<input checked="" type="checkbox"/>	During cooling operation: compressor will stop while indoor fan will operate. During heating operation, the complete unit stops.	Refer to the malfunction analysis (overload, high temperature resistant).
7	Circuit PG motor (indoor fan) has circuit malfunction by zero cross detection	U8	OFF 3S and blink for 17 times							Operation of remote controller or control panel is available, but the unit wont act.	Control board is damaged.
8	PG motor (indoor fan motor) does not operate	H6	OFF 3S and blink 11 times							The complete unit will stop operation.	Poor connection for PGF in circuit diagram; Malfunction of indoor units control panel AP1; Malfunction of indoor units motor M1.
9	Malfunction protection of jumper cap	C5	OFF 3S and blink 15 times							The complete unit will stop operation.	Poor connection for the jumper cap on indoor units control panel AP1; please reinsert or replace the jumper cap;
10	Indoor ambient temperature sensor is open/short circuited	F1		OFF 3S and blink once						During cooling and drying operation, indoor unit operates while other loads will stop; during heating operation, the complete unit will stop operation.	1.Room temperature sensor hasn't been connected well with indoor units control panel AP1 (refer to the wiring diagram for indoor unit); 2.Room temperature sensor is damaged (please refer to the resistance table of temperature sensor)

No.	Malfunction Name	Display Method of Indoor Unit				Display Method of Outdoor Unit (Indicator has 3 kinds of display status and they will be displayed circularly every 5s.)				A/C status	Possible Reasons
		Dual-8 Code Display	Indicator Display (during blinking, ON 0.5s and OFF 0.5s)			<input type="checkbox"/> OFF <input checked="" type="checkbox"/> Illuminated <input checked="" type="checkbox"/> Blink					
			Operation Indicator	Cool Indicator	Heating Indicator	D5 (D40)	D6 (D41)	D16 (D42)	D30 (D43)		
11	Indoor evaporator temperature sensor is open/short circuited	F2		OFF 3S and blink twice						During cooling and drying operation, indoor unit will operate while other loads will stop; During heating operation, the complete unit will stop operation.	1.Room temperature sensor hasnt been connected well with indoor units control panel AP1 (refer to the wiring diagram for indoor unit); 2.Room temperature sensor is damaged (please refer to the resistance table of temperature sensor)
12	Outdoor ambient temperature sensor is open/short circuited	F3		OFF 3S and blink 3 times	<input type="checkbox"/>	<input type="checkbox"/>	<input checked="" type="checkbox"/>	<input checked="" type="checkbox"/>		During cooling and drying operating, compressor stops while indoor fan operates; During heating operation, the complete unit will stop operation	Outdoor temperature sensor hasnt been connected well or is damaged. Please check it by referring to the resistance table for temperature sensor)
13	Outdoor condenser temperature sensor is open/short circuited	F4		OFF 3S and blink 4 times	<input type="checkbox"/>	<input type="checkbox"/>	<input checked="" type="checkbox"/>	<input type="checkbox"/>		During cooling and drying operation, compressor stops while indoor fan will operate; During heating operation, the complete unit will stop operation.	Outdoor temperature sensor hasnt been connected well or is damaged. Please check it by referring to the resistance table for temperature sensor)
14	Outdoor discharge temperature sensor is open/short circuited	F5		OFF 3S and blink 5 times	<input type="checkbox"/>	<input type="checkbox"/>	<input checked="" type="checkbox"/>	<input checked="" type="checkbox"/>		During cooling and drying operation, compressor will sop after operating for about 3 mins, while indoor fan will operate; During heating operation, the complete unit will stop after operating for about 3 mins.	1.Outdoor temperature sensor hasnt been connected well or is damaged. Please check it by referring to the resistance table for temperature sensor) 2.The head of temperature sensor hasnt been inserted into the copper tube
15	Limit/decrease frequency due to overload	F6		OFF 3S and blink for 6 times	<input checked="" type="checkbox"/>	<input type="checkbox"/>	<input checked="" type="checkbox"/>	<input checked="" type="checkbox"/>		All loads operate normally, while operation frequency for compressor is decreased	Refer to the malfunction analysis (overload, high temperature resistant)
16	Decrease frequency due to overcurrent	F8		OFF 3S and blink 8 times	<input checked="" type="checkbox"/>	<input checked="" type="checkbox"/>	<input type="checkbox"/>	<input checked="" type="checkbox"/>		All loads operate normally, while operation frequency for compressor is decreased	The input supply voltage is too low; System pressure is too high and overload
17	Decrease frequency due to high air discharge	F9		OFF 3S and blink 9 times	<input checked="" type="checkbox"/>	<input checked="" type="checkbox"/>	<input type="checkbox"/>	<input type="checkbox"/>		All loads operate normally, while operation frequency for compressor is decreased	Overload or temperature is too high; Refrigerant is insufficient; Malfunction of electric expansion valve (EKV)
18	Voltage for DC bus-bar is too high	PH		OFF 3S and blink 11 times	<input type="checkbox"/>	<input checked="" type="checkbox"/>	<input type="checkbox"/>	<input checked="" type="checkbox"/>		During cooling and drying operation, compressor will stop while indoor fan will operate; During heating operation, the complete unit will stop operation.	1. Measure the voltage of position L and N on wiring board (XT), if the voltage is higher than 265VAC, turn on the unit after the supply voltage is increased to the normal range. 2.If the AC input is normal, measure the voltage of electrolytic capacitor C on control panel (AP1), if its normal, theres malfunction for the circuit, please replace the control panel (AP1)
19	Malfunction of complete units current detection	U5		OFF 3S and blink 13 times	<input type="checkbox"/>	<input checked="" type="checkbox"/>	<input checked="" type="checkbox"/>	<input checked="" type="checkbox"/>		During cooling and drying operation, the compressor will stop while indoor fan will operate; During heating operating, the complete unit will stop operation.	Theres circuit malfunction on outdoor units control panel AP1, please replace the outdoor units control panel AP1.
20	Overcurrent protection of phase current for compressor	P5		OFF 3S and blink 15 times	<input type="checkbox"/>	<input checked="" type="checkbox"/>	<input type="checkbox"/>	<input type="checkbox"/>		During cooling and drying operation, compressor will stop while indoor fan will operate; During heating operation, the complete unit will stop operation.	Refer to the malfunction analysis (IPM protection, loss of synchronism protection and overcurrent protection of phase current for compressor.



No.	Malfunction Name	Display Method of Indoor Unit				Display Method of Outdoor Unit (Indicator has 3 kinds of display status and they will be displayed circularly every 5s.)				A/C status	Possible Reasons
		Dual-8 Code Display	Indicator Display (during blinking, ON 0.5s and OFF 0.5s)			<input type="checkbox"/> OFF <input checked="" type="checkbox"/> Illuminated <input checked="" type="checkbox"/> Blink					
			Operation Indicator	Cool Indicator	Heating Indicator	D5 (D40)	D6 (D41)	D16 (D42)	D30 (D43)		
31	EEPROM malfunction	EE			OFF 3S and blink 15 times	<input type="checkbox"/>	<input type="checkbox"/>	<input type="checkbox"/>	<input checked="" type="checkbox"/>	During cooling and drying operation, compressor will stop while indoor fan will operate; During heating operation, the complete unit will stop	Replace outdoor control panel AP1
32	Charging malfunction of capacitor	PU			OFF 3S and blink 17 times	<input type="checkbox"/>	<input checked="" type="checkbox"/>	<input type="checkbox"/>	<input checked="" type="checkbox"/>	During cooling and drying operation, compressor will stop while indoor fan will operate; During heating operation, the complete unit will stop	Refer to the part three—charging malfunction analysis of capacitor
33	Malfunction of module temperature sensor circuit	P7			OFF 3S and blink 18 times	<input type="checkbox"/>	<input type="checkbox"/>	<input checked="" type="checkbox"/>	<input checked="" type="checkbox"/>	During cooling and drying operation, compressor will stop while indoor fan will operate; During heating operation, the complete unit will stop	Replace outdoor control panel AP1
34	Module high temperature protection	P8			OFF 3S and blink 19 times	<input checked="" type="checkbox"/>	<input type="checkbox"/>	<input checked="" type="checkbox"/>	<input checked="" type="checkbox"/>	During cooling operation, compressor will stop while indoor fan will operate; During heating operation, the complete unit will stop	After the complete unit is de-energized for 20mins, check whether the thermal grease on IPM Module of outdoor control panel AP1 is sufficient and whether the radiator is inserted tightly. If its no use, please replace control panel AP1.
35	Malfunction of voltage dropping for DC bus-bar	U3			OFF 3S and blink 20 times	<input type="checkbox"/>	<input checked="" type="checkbox"/>	<input checked="" type="checkbox"/>	<input checked="" type="checkbox"/>	During cooling and drying operation, compressor will stop while indoor fan will operate; During heating operation, the complete unit will stop	Supply voltage is unstable
36	Voltage of DC bus-bar is too low	PL			OFF 3S and blink 21 times	<input type="checkbox"/>	<input checked="" type="checkbox"/>	<input checked="" type="checkbox"/>	<input type="checkbox"/>	During cooling and drying operation, compressor will stop while indoor fan will operate; During heating operation, the complete unit will stop	1. Measure the voltage of position L and N on wiring board (XT), if the voltage is higher than 150VAC, turn on the unit after the supply voltage is increased to the normal range. 2.If the AC input is normal, measure the voltage of electrolytic capacitor C on control panel (AP1), if its normal, theres malfunction for the circuit, please replace the control panel (AP1)
37	Limit/decrease frequency due to high temperature of module	EU				<input checked="" type="checkbox"/>	<input checked="" type="checkbox"/>	<input checked="" type="checkbox"/>	<input checked="" type="checkbox"/>	All loads operate normally, while operation frequency for compressor is decreased	Discharging after the complete unit is de-energized for 20mins, check whether the thermal grease on IPM Module of outdoor control panel AP1 is sufficient and whether the radiator is inserted tightly. If its no use, please replace control panel AP1.
38	The four-way valve is abnormal	U7				<input checked="" type="checkbox"/>	<input type="checkbox"/>	<input checked="" type="checkbox"/>	<input type="checkbox"/>	If this malfunction occurs during heating operation, the complete unit will stop operation.	1.Supply voltage is lower than AC175V; 2.Wiring terminal 4V is loosened or broken; 3.4V is damaged, please replace 4V.
39	Zero-crossing malfunction of outdoor unit	U9				<input checked="" type="checkbox"/>	<input checked="" type="checkbox"/>	<input checked="" type="checkbox"/>	<input type="checkbox"/>	During cooling operation, compressor will stop while indoor fan will operate; during heating,the complete unit will stop operation.	Replace outdoor control panel AP1
40	Limit/decrease frequency due to antifreezing	FH				<input checked="" type="checkbox"/>	<input checked="" type="checkbox"/>	<input checked="" type="checkbox"/>	<input type="checkbox"/>	All loads operate normally, while operation frequency for compressor is decreased	Poor air-return in indoor unit or fan speed is too low

## 9.2 How to Check Simply the Main Part

Indoor unit:

(1)Temperature sensor malfunction

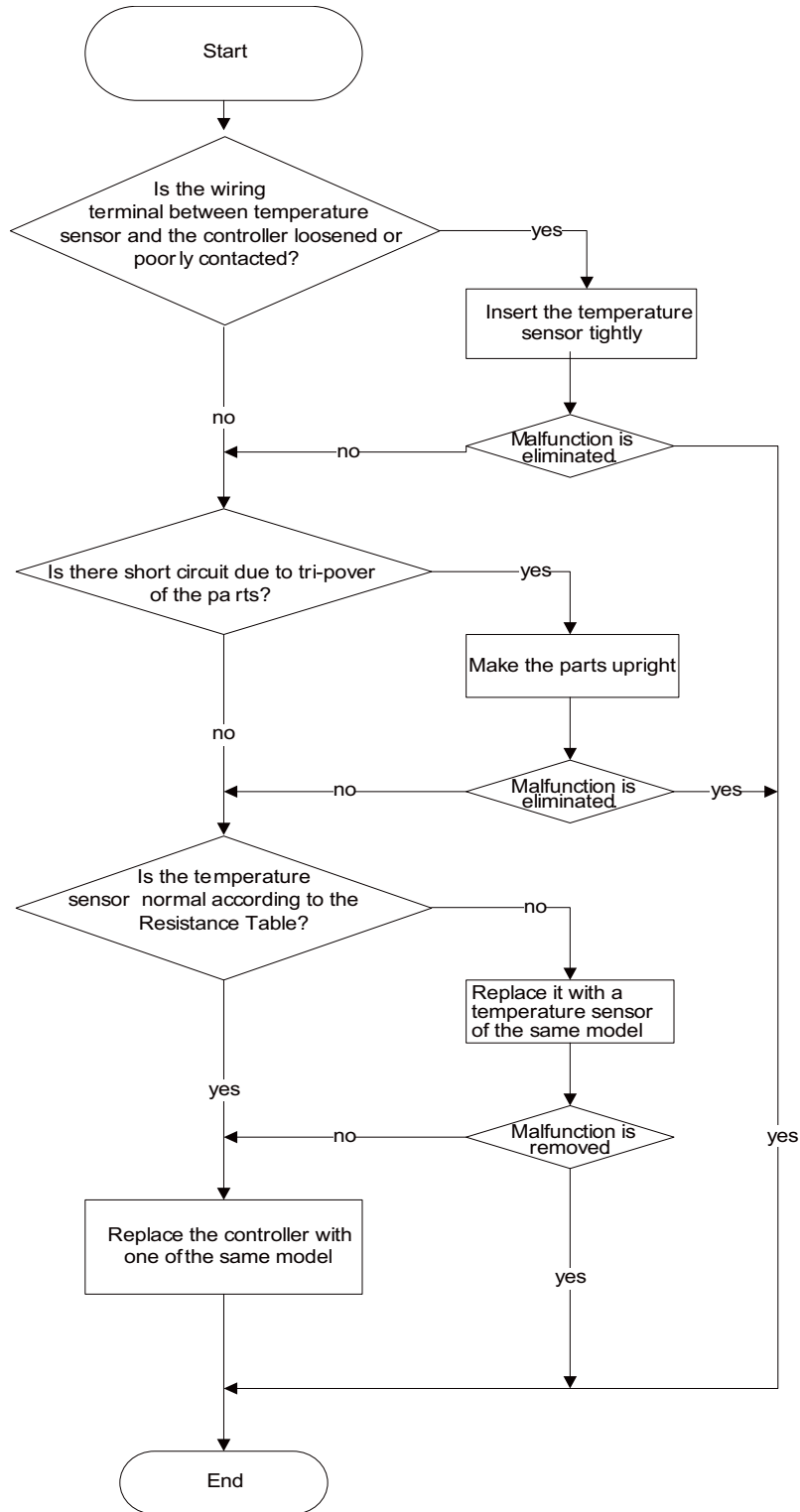

(2)Malfunction of Blocked Protection of IDU Fan Motor H6

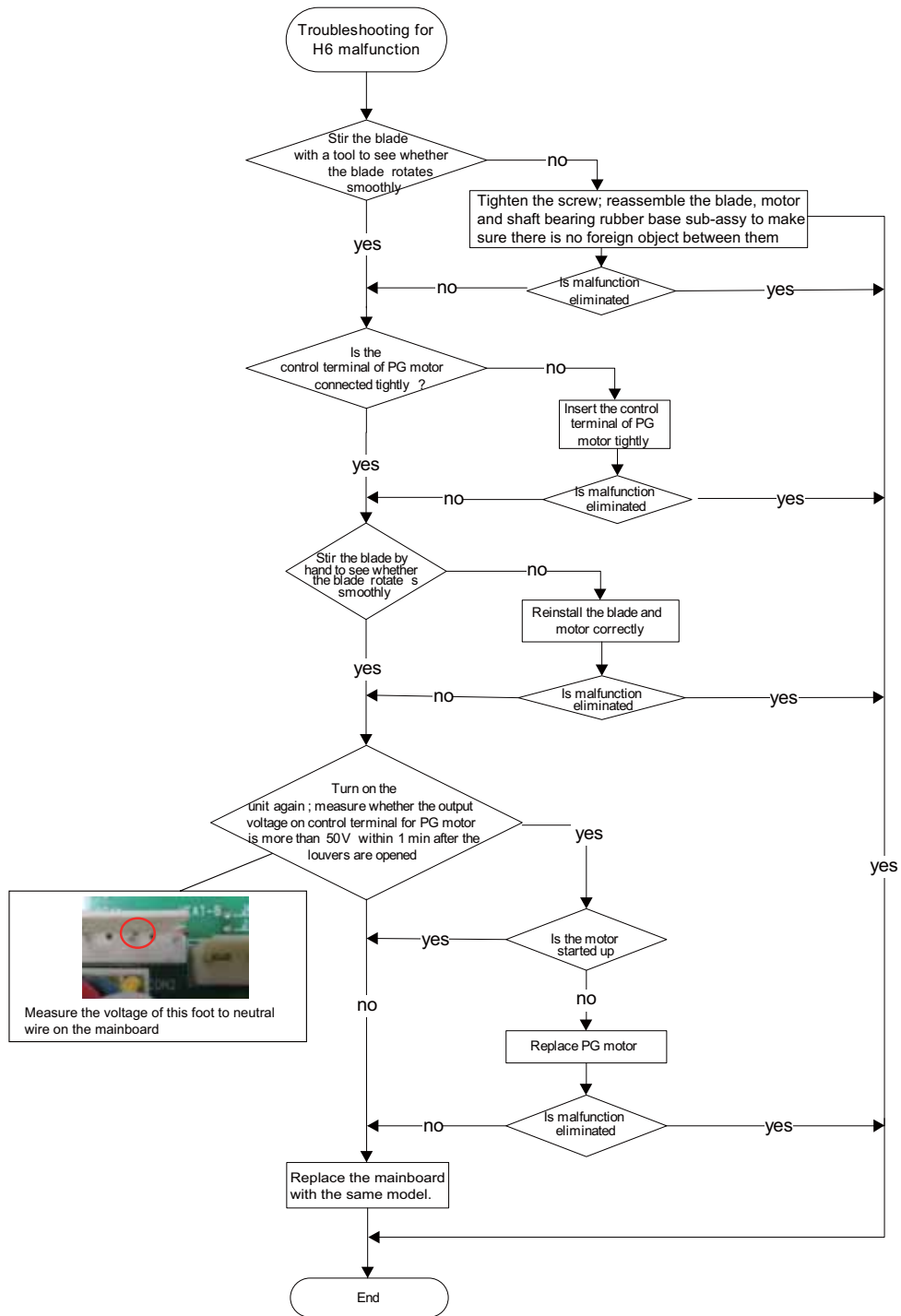



(4)Overcurrent protection (E5)

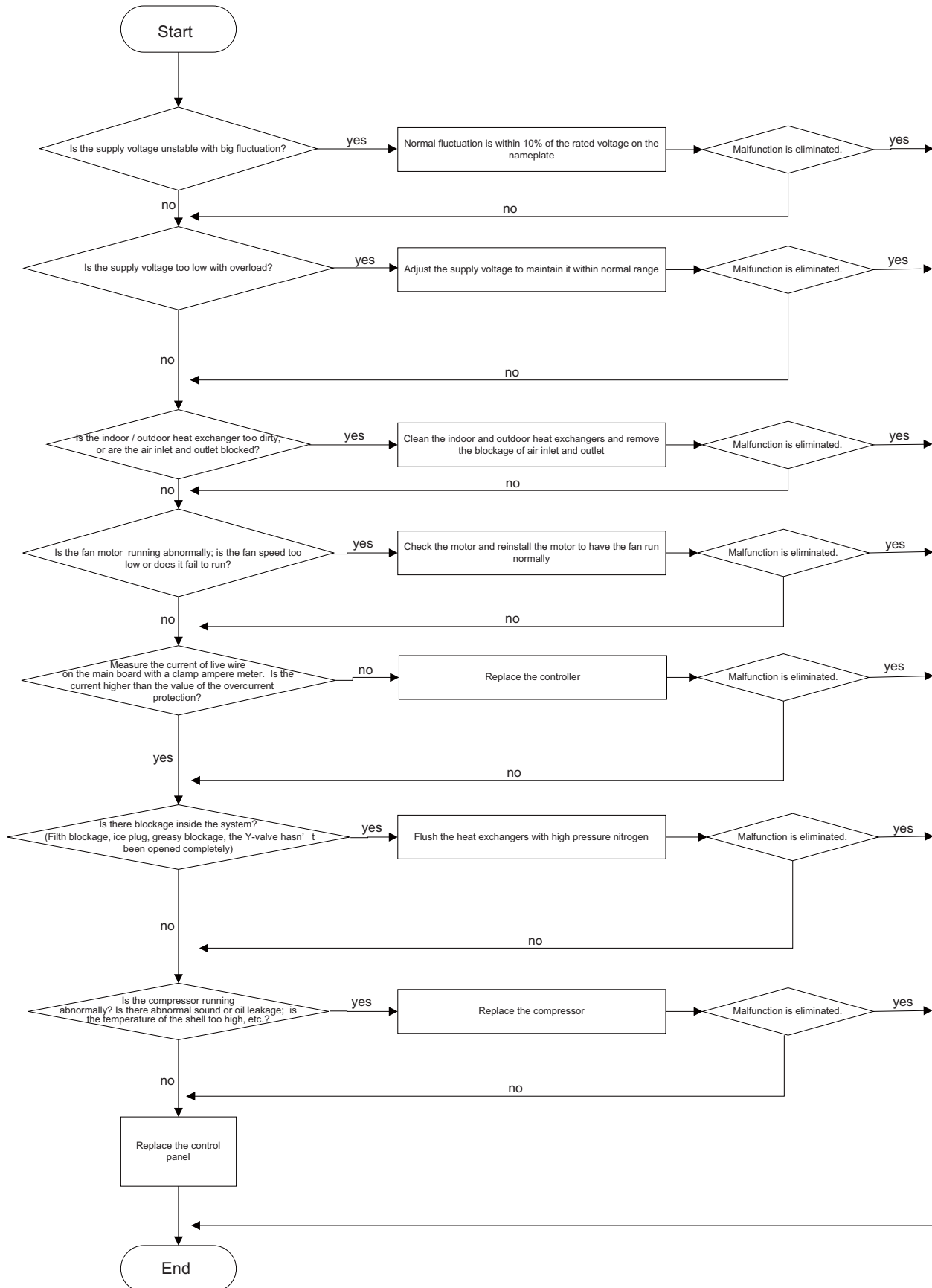

Outdoor unit:

(1)Key detection point

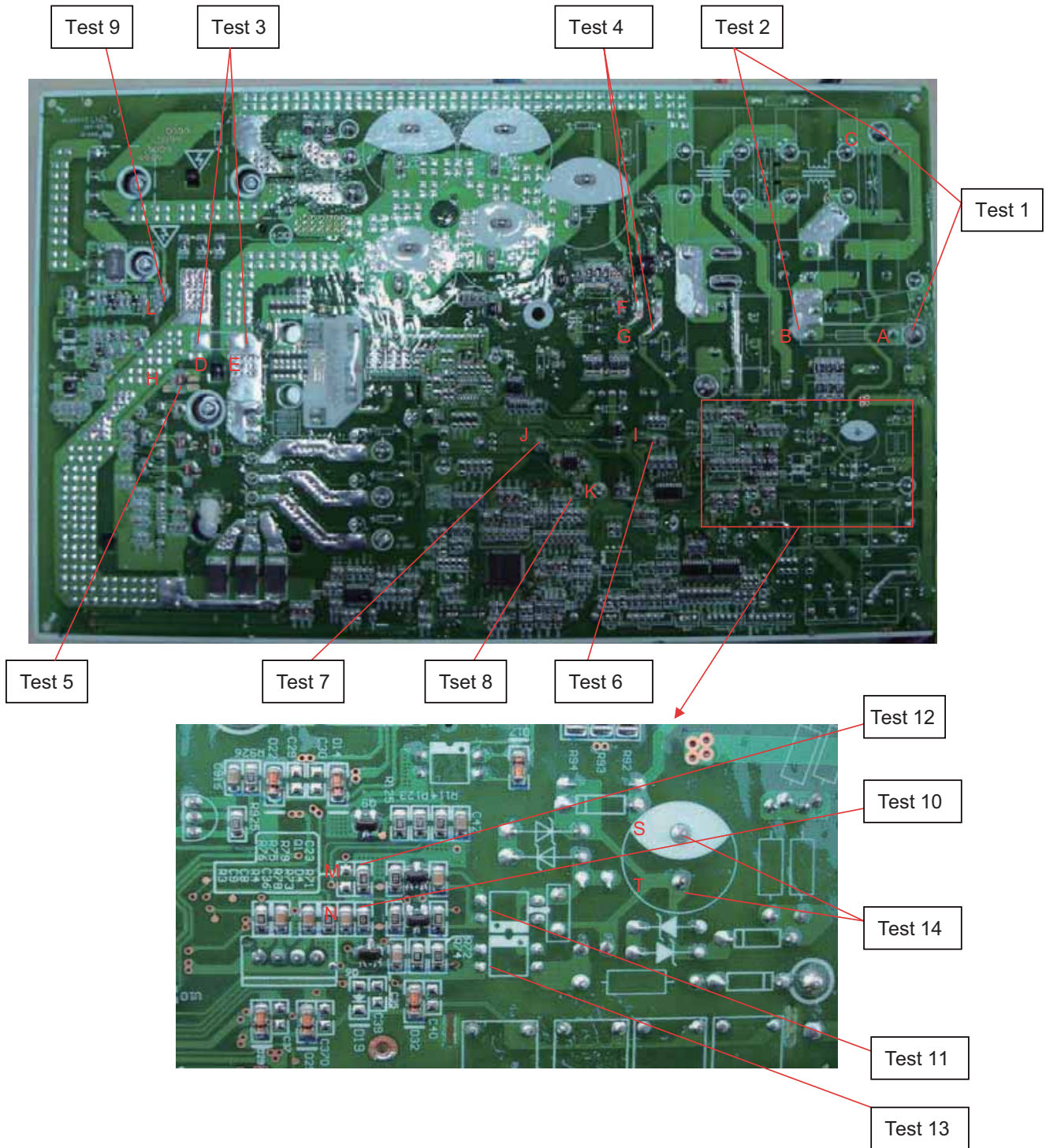

Test No.	Test point	Corresponding component	Test value under normal condition
test 1	Between A and C	Neutral and live wires	160V~265V
test 2	Between B and C	Neutral and live wires	160V~265V
test 3	Between D and E	DC busbar electrolytic capacitor	DC 180V~380V
test 4	Between F and G	Electrolytic capacitor of power	DC 180V~380V
test 5	Both ends of diode	D10(IPM module and 15V power supply)	DC 14.5V~15.6V
test 6	Both ends of sheet capacitor C911	C911(+12V power supply)	DC 12V~13V
test 7	Both ends of sheet capacitor C914	C914(+5V power supply)	DC 5V
test 8	Both ends of sheet capacitor C83	C83(+3.3V power supply)	DC 3.3V
test 9	Both ends of sheet capacitor C912	C912+(17V power supply)	DC 15V~18V
test 10	Between point N and GND	Terminal N of R78 to earth(Outdoor unit signal receiver port)	Fluctuate between 0~3.3V
test 11	U12	U12 leading feet(between 1 and 2)	Fluctuate between 0~3.3V
test 12	Between point M and GND	Terminal M of R75 to earth(Outdoor unit signal sending port)	Fluctuate between 0~3.3V
test 13	U15	U15 leading feet(between 3 and 4)	Fluctuate between 0~3.3V
test 14	Between S and T	Communication circle power supply	DC 56V

●Discharging method

(1) remove the inverter cover(Outdoor Unit)

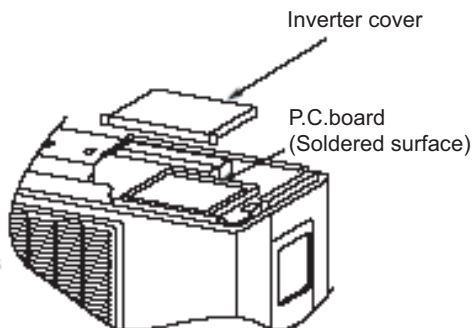

(2)As shown below,connect the discharge resistance(approx.100Ω20W)or plug of the sold ering iron to voltage between + - terminals of the electrolytic capacitor (test3 “D ” and “E” point) on PC Board for 30s, and then peformedischarging.

NOTE:

A large-capacity electrolytic capacitor is used in the outdoor unit controller(inverter).Therefore,if the power supply is turned off,charge(charging voltage DC280V to 380V)remains and disc harging takes a lot of time.. After turning off the power source,if touching the charging section before discharging, an electrical shock may be caused. Discharge the electrol ytic capacitor completely by using soldering iron,etc.

**(2)Capacity charging malfunction (outdoor unit malfunction) (AP1 below is control board of outdoor unit)**

**Main detection point:**

- Detect if the voltage of L and N terminal of wiring board is between 210VAC-240VAC by alternating voltage meter;
- Is reactor (L) well connected? Is connection wire loosened or pull-out? Is reactor (L) damaged?

**Malfunction diagnosis process:**

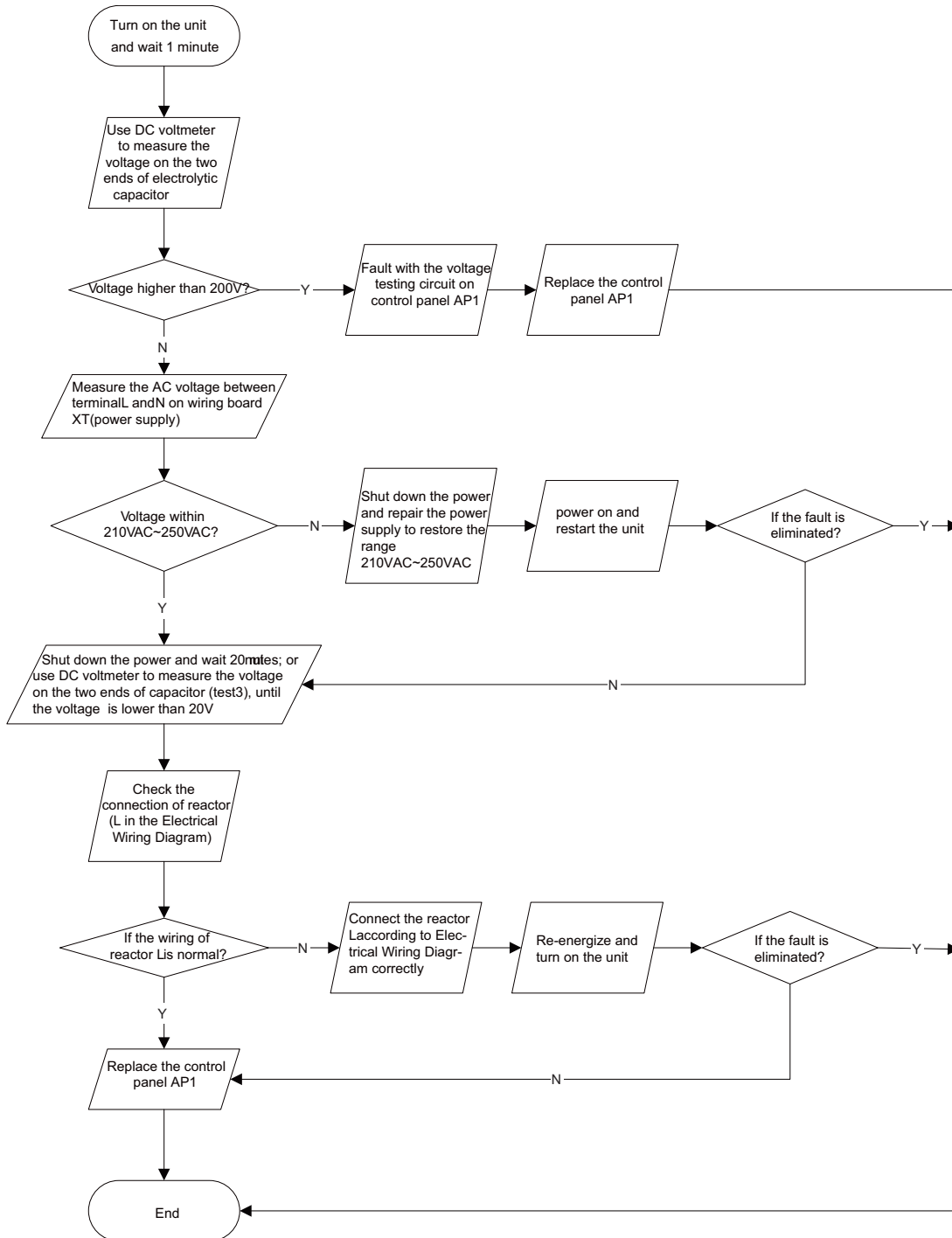

**(3)IPM protection, desynchronizing malfunction, phase current of compressor is overcurrent (AP1 below is control board of outdoor unit)**

**Main detection point:**

- If control board AP1 and compressor COMP is well connected? If they are loosened? If the connection sequence is correct?
- Is voltage input in the normal range (Test the voltage between L, N of wiring board XT by DC voltage meter)?
- If coil resistance of compressor is normal? Is compressor coil insulating to copper pipe well?
- If the work load of unit is heavy? If radiating of unit is well?
- If the refrigerant charging is appropriate?

**Malfunction diagnosis process:**

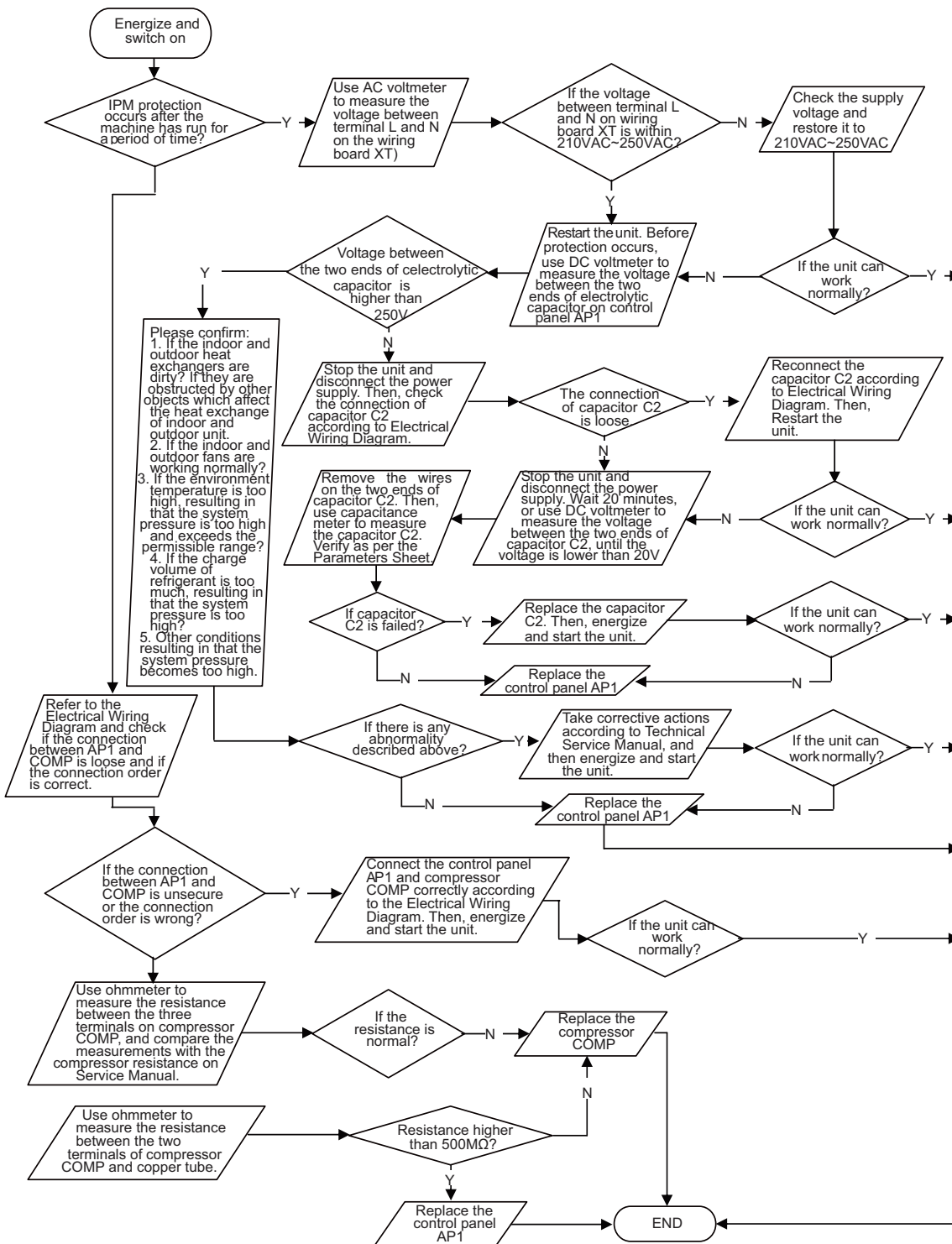



**(5)Diagnosis for failure start up malfunction (AP1 below is control board of outdoor unit)**

**Main detection point:**

- If the compressor wiring is correct?
- If the stop time of compressor is enough?
- If the compressor is damaged?
- If the refrigerant charging is too much?

**Malfunction diagnosis process:**

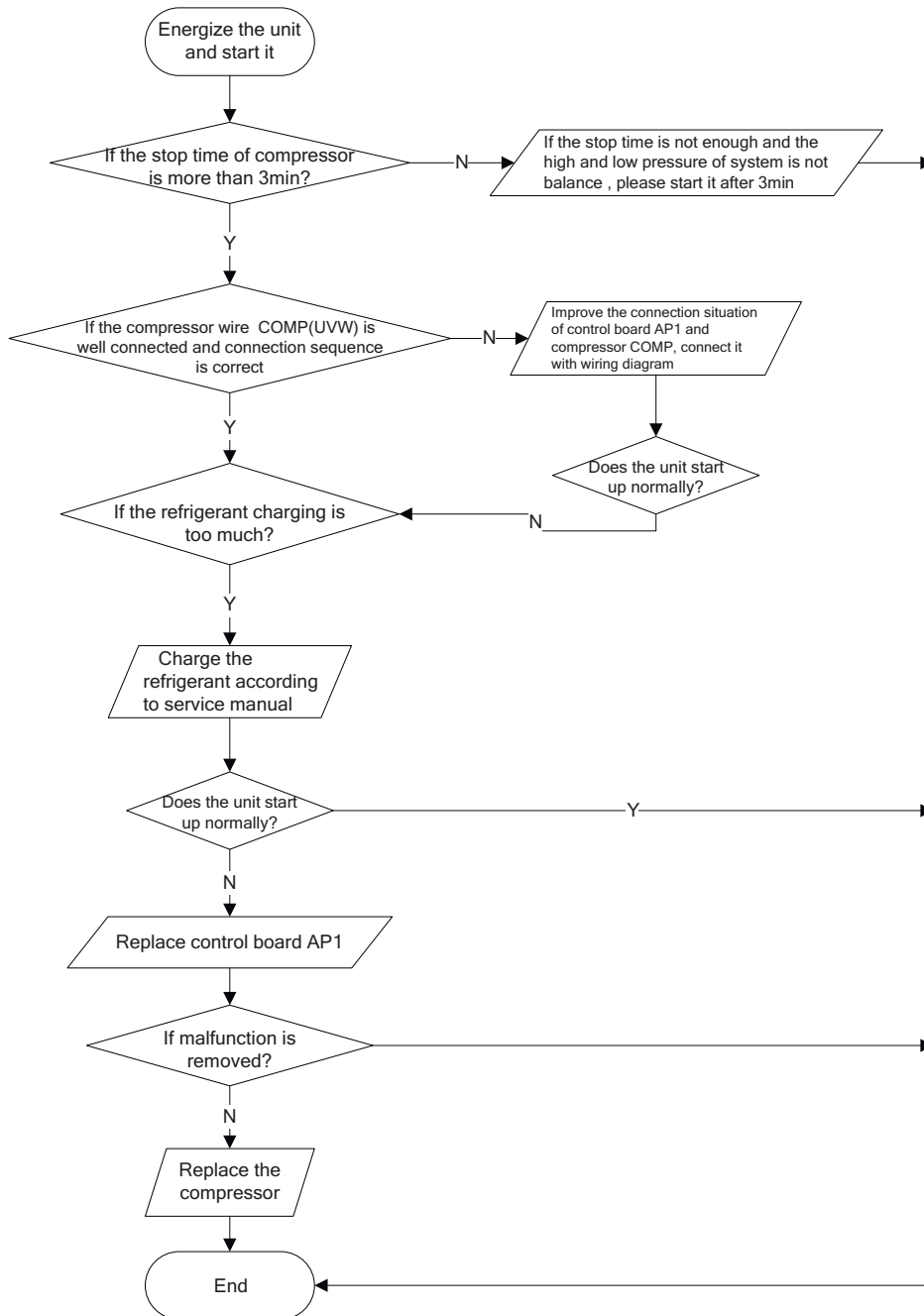



**(7)Diagnosis for overload and discharge malfunction (AP1 below is control board of outdoor unit)**

**Main detection point:**

- If the electron expansion valve is connected well? Is the expansion valve damaged?
- If the refrigerant is leakage?
- If the overload protector is damaged?

**Malfunction diagnosis process:**

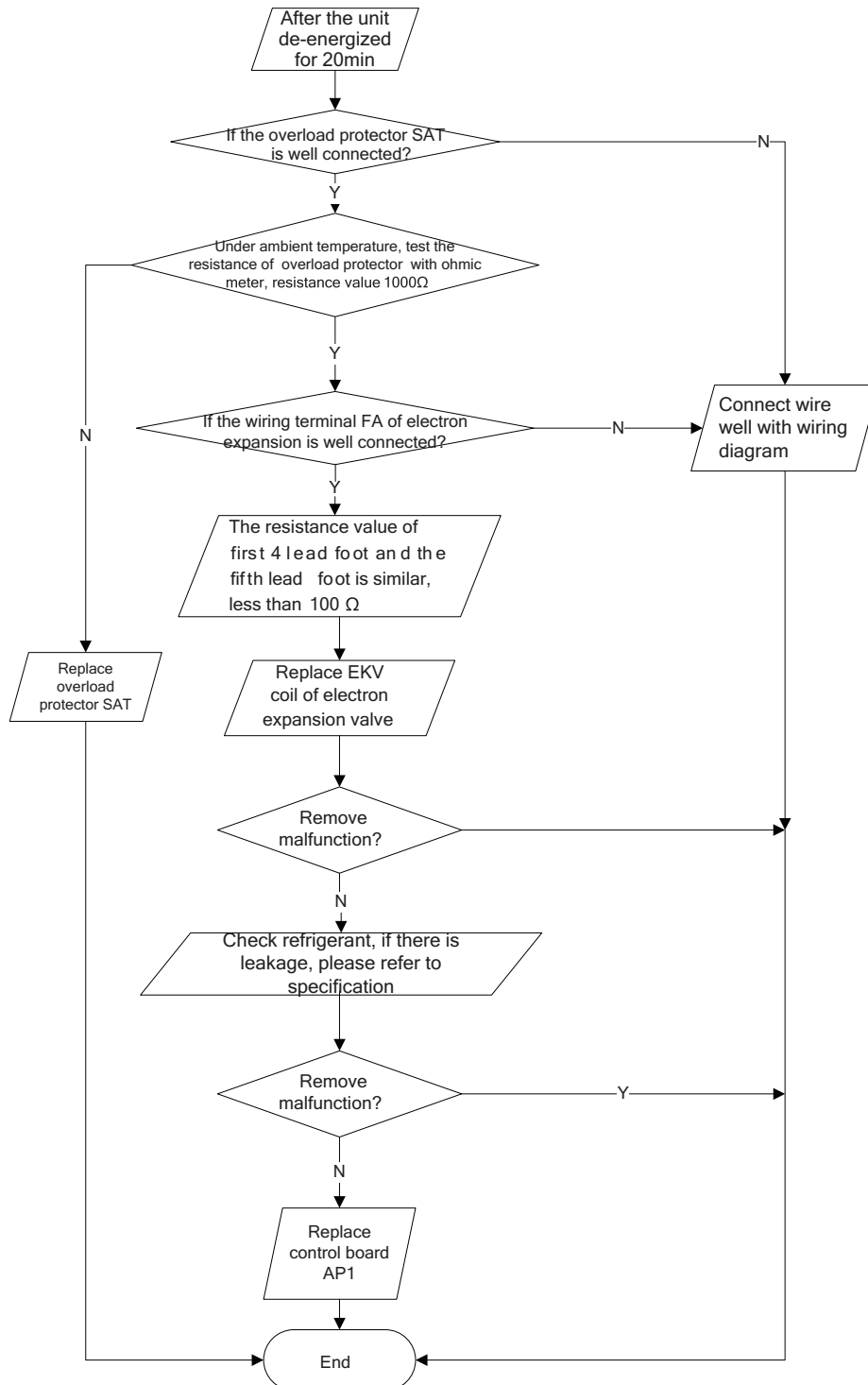



**(9)Communication malfunction (AP1 below is control board of outdoor unit)**

**Main detection point:**

- Check if the connection wire and the built-in wiring of indoor and outdoor unit is connected well and no damaged;
- If the communication circuit of indoor mainboard is damaged? If the communication circuit of outdoor mainboard (AP1) is damaged?

**Malfunction diagnosis process:**

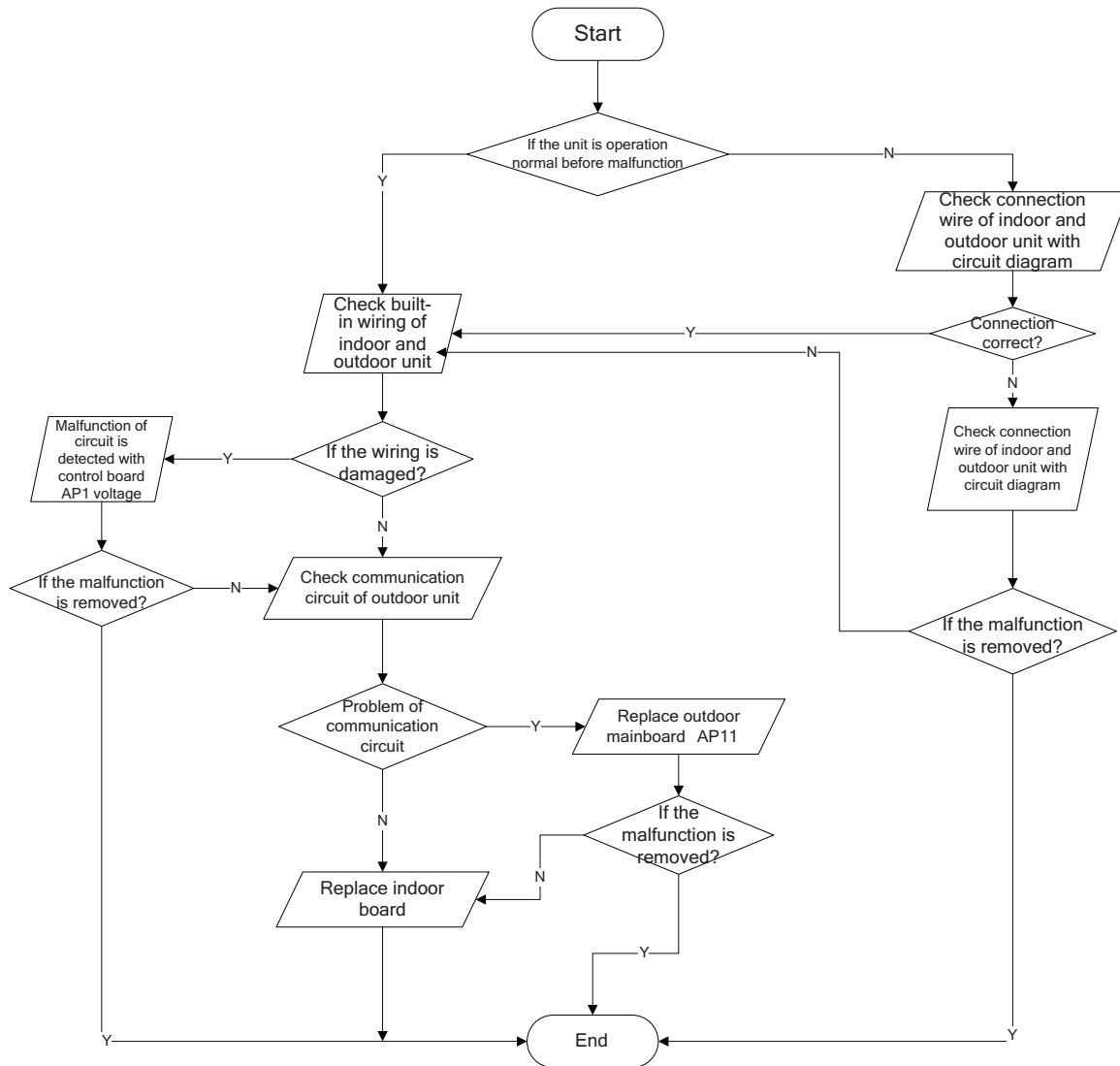



## 9.3 Troubleshooting for Normal Malfunction

### 1. Air Conditioner Can't be Started Up

Possible Causes	Discriminating Method (Air conditioner Status)	Troubleshooting
No power supply, or poor connection for power plug	After energization, operation indicator isn't bright and the buzzer can't give out sound	Confirm whether it's due to power failure. If yes, wait for power recovery. If not, check power supply circuit and make sure the power plug is connected well.
Wrong wire connection between indoor unit and outdoor unit, or poor connection for wiring terminals	Under normal power supply circumstances, operation indicator isn't bright after energization	Check the circuit according to circuit diagram and connect wires correctly. Make sure all wiring terminals are connected firmly
Electric leakage for air conditioner	After energization, room circuit breaker trips off at once	Make sure the air conditioner is grounded reliably Make sure wires of air conditioner is connected correctly Check the wiring inside air conditioner. Check whether the insulation layer of power cord is damaged; if yes, place the power cord.
Model selection for air switch is improper	After energization, air switch trips off	Select proper air switch
Malfunction of remote controller	After energization, operation indicator is bright, while no display on remote controller or buttons have no action.	Replace batteries for remote controller Repair or replace remote controller

### 2. Poor Cooling (Heating) for Air Conditioner

Possible Causes	Discriminating Method (Air conditioner Status)	Troubleshooting
Set temperature is improper	Observe the set temperature on remote controller	Adjust the set temperature
Rotation speed of the IDU fan motor is set too low	Small wind blow	Set the fan speed at high or medium
Filter of indoor unit is blocked	Check the filter to see it's blocked	Clean the filter
Installation position for indoor unit and outdoor unit is improper	Check whether the installation position is proper according to installation requirement for air conditioner	Adjust the installation position, and install the rainproof and sunproof for outdoor unit
Refrigerant is leaking	Discharged air temperature during cooling is higher than normal discharged wind temperature; Discharged air temperature during heating is lower than normal discharged wind temperature; Unit's pressure is much lower than regulated range	Find out the leakage causes and deal with it. Add refrigerant.
Malfunction of 4-way valve	Blow cold wind during heating	Replace the 4-way valve
Malfunction of capillary	Discharged air temperature during cooling is higher than normal discharged wind temperature; Discharged air temperature during heating is lower than normal discharged wind temperature; Unit's pressure is much lower than regulated range. If refrigerant isn't leaking, part of capillary is blocked	Replace the capillary
Flow volume of valve is insufficient	The pressure of valves is much lower than that stated in the specification	Open the valve completely
Malfunction of horizontal louver	Horizontal louver can't swing	Refer to point 3 of maintenance method for details
Malfunction of the IDU fan motor	The IDU fan motor can't operate	Refer to troubleshooting for H6 for maintenance method in details
Malfunction of the ODU fan motor	The ODU fan motor can't operate	Refer to point 4 of maintenance method for details
Malfunction of compressor	Compressor can't operate	Refer to point 5 of maintenance method for details

### 3. Horizontal Louver Can't Swing

Possible Causes	Discriminating Method (Air conditioner Status)	Troubleshooting
Wrong wire connection, or poor connection	Check the wiring status according to circuit diagram	Connect wires according to wiring diagram to make sure all wiring terminals are connected firmly
Stepping motor is damaged	Stepping motor can't operate	Repair or replace stepping motor
Main board is damaged	Others are all normal, while horizontal louver can't operate	Replace the main board with the same model

**4. ODU Fan Motor Can't Operate**

Possible causes	Discriminating method (air conditioner status)	Troubleshooting
Wrong wire connection, or poor connection	Check the wiring status according to circuit diagram	Connect wires according to wiring diagram to make sure all wiring terminals are connected firmly
Capacity of the ODU fan motor is damaged	Measure the capacity of fan capacitor with an universal meter and find that the capacity is out of the deviation range indicated on the nameplate of fan capacitor.	Replace the capacity of fan
Power voltage is a little low or high	Use universal meter to measure the power supply voltage. The voltage is a little high or low	Suggest to equip with voltage regulator
Motor of outdoor unit is damaged	When unit is on, cooling/heating performance is bad and ODU compressor generates a lot of noise and heat.	Change compressor oil and refrigerant. If no better, replace the compressor with a new one

**5. Compressor Can't Operate**

Possible causes	Discriminating method (air conditioner status)	Troubleshooting
Wrong wire connection, or poor connection	Check the wiring status according to circuit diagram	Connect wires according to wiring diagram to make sure all wiring terminals are connected firmly
Capacity of compressor is damaged	Measure the capacity of fan capacitor with an universal meter and find that the capacity is out of the deviation range indicated on the nameplate of fan capacitor.	Replace the compressor capacitor
Power voltage is a little low or high	Use universal meter to measure the power supply voltage. The voltage is a little high or low	Suggest to equip with voltage regulator
Coil of compressor is burnt out	Use universal meter to measure the resistance between compressor terminals and it's 0	Repair or replace compressor
Cylinder of compressor is blocked	Compressor can't operate	Repair or replace compressor

**6. Air Conditioner is Leaking**

Possible causes	Discriminating method (air conditioner status)	Troubleshooting
Drain pipe is blocked	Water leaking from indoor unit	Eliminate the foreign objects inside the drain pipe
Drain pipe is broken	Water leaking from drain pipe	Replace drain pipe
Wrapping is not tight	Water leaking from the pipe connection place of indoor unit	Wrap it again and bundle it tightly

**7. Abnormal Sound and Vibration**

Possible causes	Discriminating method (air conditioner status)	Troubleshooting
When turn on or turn off the unit, the panel and other parts will expand and there's abnormal sound	There's the sound of "PAPA"	Normal phenomenon. Abnormal sound will disappear after a few minutes.
When turn on or turn off the unit, there's abnormal sound due to flow of refrigerant inside air conditioner	Water-running sound can be heard	Normal phenomenon. Abnormal sound will disappear after a few minutes.
Foreign objects inside the indoor unit or there're parts touching together inside the indoor unit	There's abnormal sound fro indoor unit	Remove foreign objects. Adjust all parts' position of indoor unit, tighten screws and stick damping plaster between connected parts
Foreign objects inside the outdoor unit or there're parts touching together inside the outdoor unit	There's abnormal sound fro outdoor unit	Remove foreign objects. Adjust all parts' position of outdoor unit, tighten screws and stick damping plaster between connected parts
Short circuit inside the magnetic coil	During heating, the way valve has abnormal electromagnetic sound	Replace magnetic coil
Abnormal shake of compressor	Outdoor unit gives out abnormal sound	Adjust the support foot mat of compressor, tighten the bolts
Abnormal sound inside the compressor	Abnormal sound inside the compressor	If add too much refrigerant during maintenance, please reduce refrigerant properly. Replace compressor for other circumstances.

# 10. Exploded View and Parts List

## 10.1 Indoor Unit

MWM18Y3J MWM24Y3J

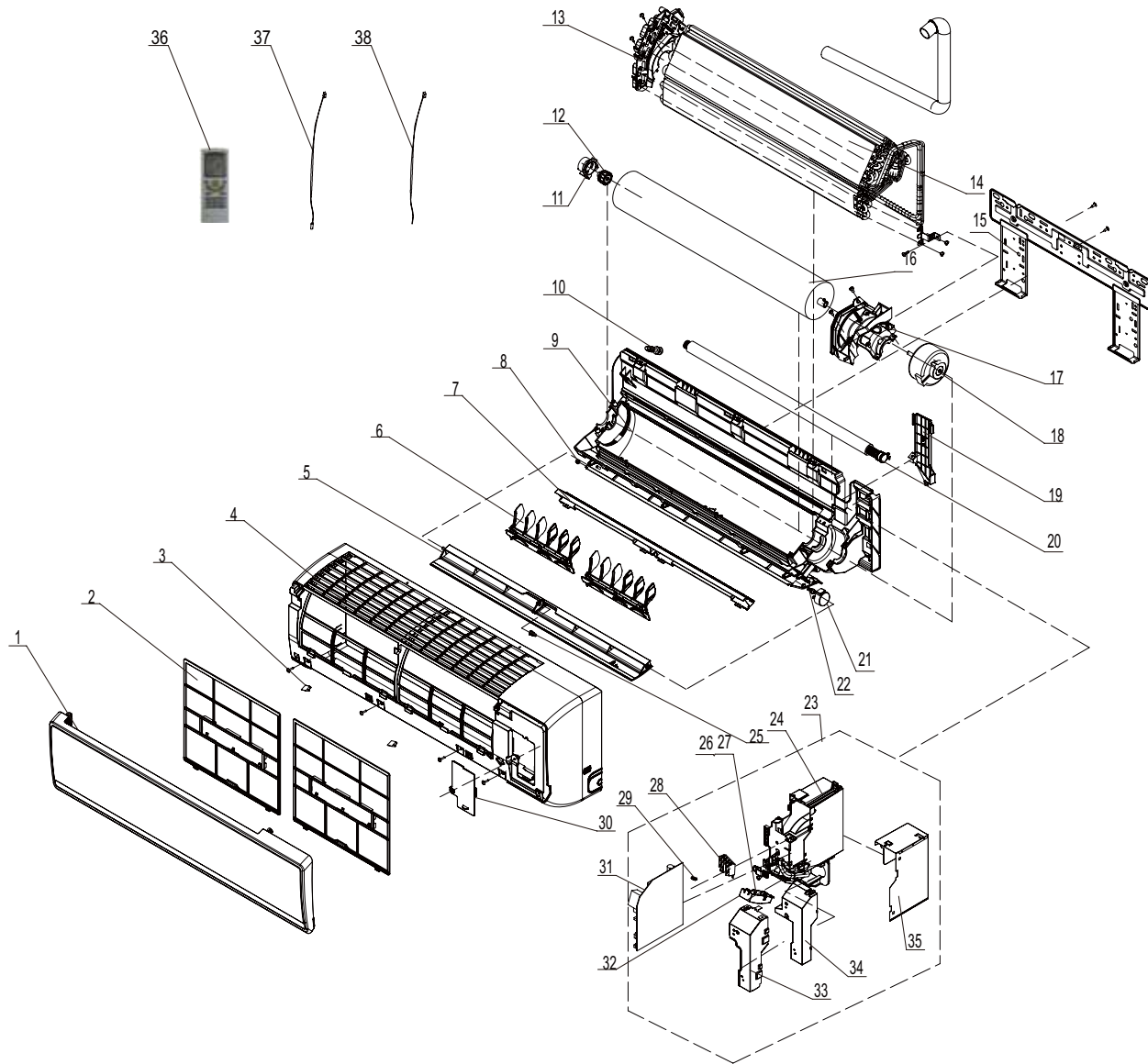



No.	Description	Part Code	Qty
		MWM24Y3J	
		Product Code	
		CB146N32101_L13396	
1	Front Panel Assy	27230002465	1
2	Filter Sub-Assy	11122091	2
3	Screw Cover	24252016	3
4	Front Case Assy	2001251401	1
5	Guide Louver	10512138	1
6	Air Louver	10512139	3
7	Helicoid Tongue	26112229	1
8	Left Axile Bush	10512037	1
9	Rear Case Assy	2220215701	1
10	Rubber Plug (Water Tray)	76712012	1
11	O-Gasket Sub-Assy of Bearing	7651205102	1
12	O-Gasket of Cross Fan Bearing	76512203	1
13	Evaporator Support	24212103	1
14	Evaporator Assy	01002269	1
15	Wall Mounting Frame	01252032	1
16	Cross Flow Fan	10352030	1
17	Motor Press Plate	26112316	1
18	Fan Motor	1501209801	1
19	Pipe Clamp	2611218801	1
20	Drainage Hose	0523001405	1
21	Step Motor	1521300101	1
22	Crank	10582070	1
23	Electric Box Assy	10000200152	1
24	Electric Box	2011210302	1
25	Axile Bush	10542036	2
26	Indicator Light Cover	22242084	1
27	Indicator Shield Cover	22242083	1
28	Terminal Board	42011233	1
29	Jumper	4202300121	1
30	Electric Box Cover2	2011208112	1
31	Main Board	30138517	1
32	Display Board	30568112	1
33	Shield Cover of Electric Box Cover	01592088	1
34	Electric Box Cover	2012212302	1
35	Shield cover of Electric Box	01592087	1
36	Remote Controller	30510511_L13396	1
37	Temperature Sensor	390000453	1
38	Temperature Sensor	390000591	1

Above data is subject to change without notice.



No.	Description	Part Code	Qty
		MRM18Y3J	
		Product Code CB146W17401_L13396	
1	Fan Motor	1501506302	1
2	Clapboard Assy	01232902	1
3	Terminal Board	42010255	1
4	Electric Box	20113015	1
5	Radiator	49010252	1
6	Main Board	301485391	1
7	Electric Box Assy	02613326	1
8	Handle	26233053	1
9	Left Side Plate	01305093P	1
10	Motor Support Sub-Assy	01705020	1
11	Supporting Board(Condenser)	01795010	1
12	Coping	01255005P	1
13	Reactor	43130021	1
14	Clapboard Sub-Assy	01232902	1
15	Condenser Assy	01163465	1
16	Rear Grill	01473043	1
17	Wiring clamp	26115004	1
18	Temperature Sensor	3900030901	1
19	Handle assy	02113109	1
20	Cut off Valve	07133472	1
21	Valve cover	22245002	1
22	Cut off Valve Assy 1/2	07133060	1
23	Valve Support Assy	01715010P	1
24	Right Side Plate	0130509403P	1
25	Capillary Sub-assy	03063947	1
26	4-Way Valve Assy	03123884	1
27	Magnet Coil	4300040045	1
28	Compressor and fittings	00205262	1
29	Chassis Sub-assy	02803122P	1
30	Axial Flow Fan	10335008	1
31	Insulated board (cover of electric box)	20113003	1
32	Cabinet	01433047P	1
33	Front Grill	01473049	1
34	Electrical Heater (Chassis)	7651000411	1

Above data is subject to change without notice.



No	Description	Part Code	Qty
		MRM24Y3J	
		Product Code CB146W0141_L13396	
1	Fan Motor	1501506302	1
2	Electric box (fireproofing)	01413148	1
3	Terminal Board	42010255	1
4	Capacitor CBB61	33010010	1
5	Electric Box	20113015	1
6	Radiator	49010252	1
7	Main Board	301483642	1
8	Electric Box Cover Sub-Assy	02603217	1
9	Electric Box Assy	02613272	1
10	left handle	2623540103	1
11	Left Side Plate	01305093P	1
12	Motor Support Sub-Assy	01705020	1
13	Supporting board(condenser)	01795010	1
14	Top Cover	01255005P	1
15	Reactor	43130021	1
16	Clapboard Sub-Assy	01232902	1
17	Condenser Assy	0111338603	1
18	Front Grill	01473049	1
19	Wiring clamp	26115004	1
20	Temperature Sensor	3900030901	1
21	Capacitor CBB65	33000065	1
22	Capacitor Clamp sub-assy	01413098	1
23	Electric expand valve fitting	4300876704	1
24	Handle Assy	02113109	1
25	Cut-off valve Sub-Assy	07133058	1
26	Valve cover	22245002	1
27	Cut-off valve Sub-Assy	07133060	1
28	Valve support assy	01715010P	1
29	Right Side Plate	0130509403P	1
30	Electronic Expansion Valve	07135228	1
31	4-way Valve Assy	03123245	1
32	Magnet Coil	4300040045	1
33	Compressor and fittings	00103501	1
34	Chassis Sub-assy	0280305701P	1
35	Drainage Connector	06123401	1
36	Drainage Plug	06813401	3
37	Axial Flow Fan	10335008	1
38	Insulated board (cover of electric box)	20113003	1
39	Cabinet	01433047P	1
40	Rear Grill	01473043	1
41	Electrical Heater (Chassis)	/	/

Above data is subject to change without notice.

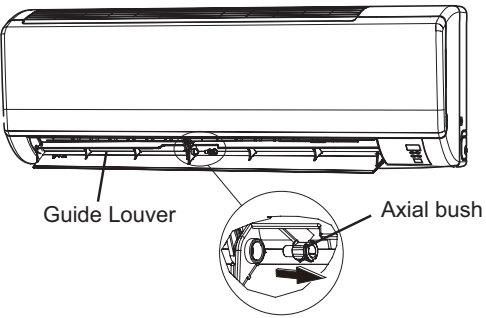
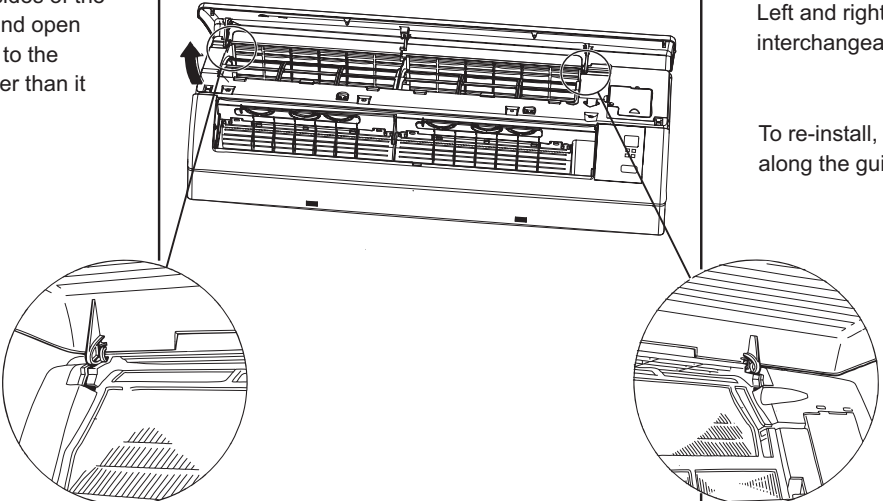
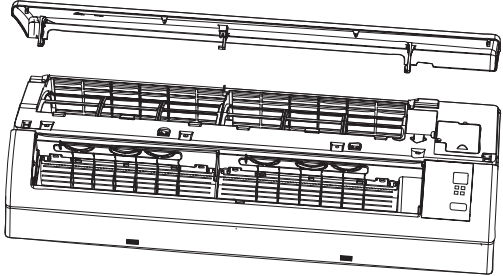

Steps	Procedure	Points
3. Opening and shutting front panel		
a	<p>Draw out the axial bush. Bend the horizontal louver slightly and then remove it.</p>  <p>Guide Louver      Axial bush</p>	<p>Support the front panel by one hand, while remove the rotation axis at the upper center by the other hand.</p>
b	<p>Hook a finger onto the projection part provided on the both sides of the units panel and open up the panel to the position higher than it will stop.</p> 	<p>Left and right filters are interchangeable.</p> <p>To re-install, insert air filter along the guide.</p>
c	<p>Remove the front panel from the unit.</p> 	

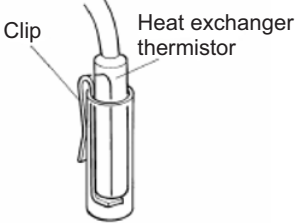

Steps	Procedure	Points
6. Remove electrical box		
a	Disconnect the Cable clamp	<p>Pay attention to the direction of the retainer of the thermistor so that the retainer will not touch the harness (same as the existing models.)</p>
b	<p>Remove Temperature Sensor; Disconnect the connection wires. Twist off the earthing screw fixing the evaporator; Pull out the all the wiring terminals</p>	<p>Take care not to lose the clip of thermistor</p> 
c	Remove a screw on the electrical box.	

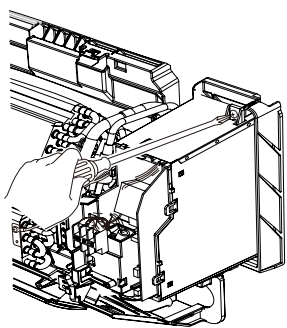
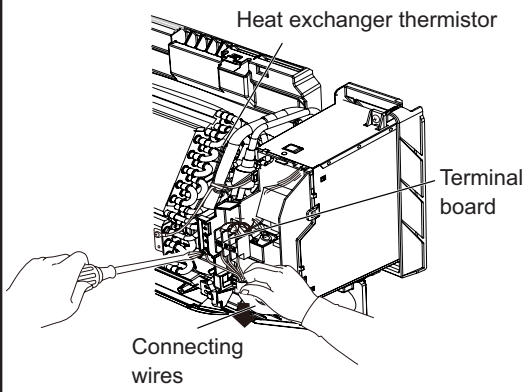
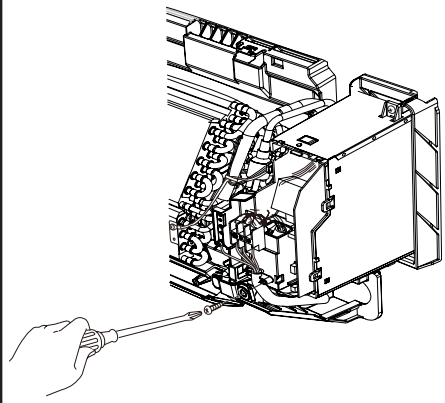





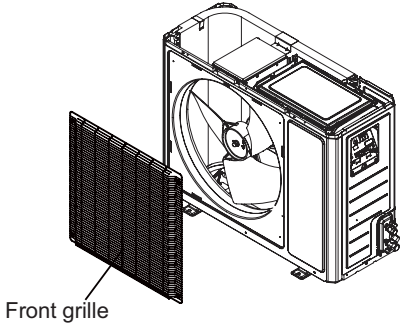
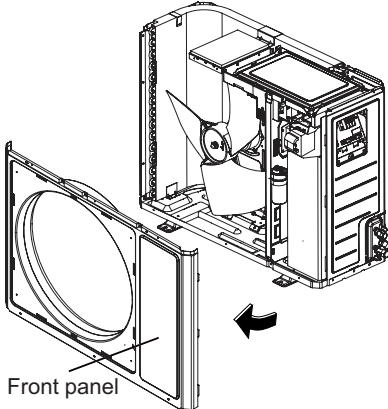
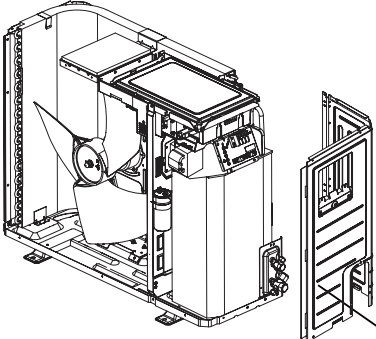
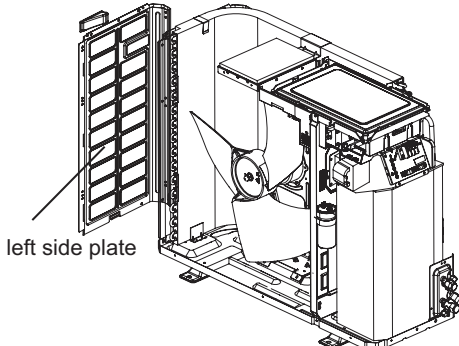

Steps	Procedure	Points
2.Remove front grille and front panel	<p data-bbox="175 317 521 432">a Remove the screws connecting the front grille and the front panel. Remove the front grille.</p>  <p data-bbox="560 562 667 590">Front grille</p> <p data-bbox="175 722 496 911">b Twist off the screws fixing the panel, pull it upward, loosen the clasp on the right side, rotate it to the left and then remove the front panel.</p>  <p data-bbox="602 974 716 1001">Front panel</p>	<p data-bbox="1122 814 1458 905">Lift the front panel and remove it while pushing the right side panel inwards.</p>
3.Remove left side plate and right side plate	<p data-bbox="175 1157 505 1356">a Remove the screws connecting the right side plate with the chassis, the valve support and the electric box, and then remove the right side plate assy.</p>  <p data-bbox="894 1415 1057 1442">Right Side Plate</p> <p data-bbox="175 1472 488 1608">b Remove the screws connecting the left side plate and the chassis, and then remove the left side plate assy.</p>  <p data-bbox="545 1717 675 1745">left side plate</p>	

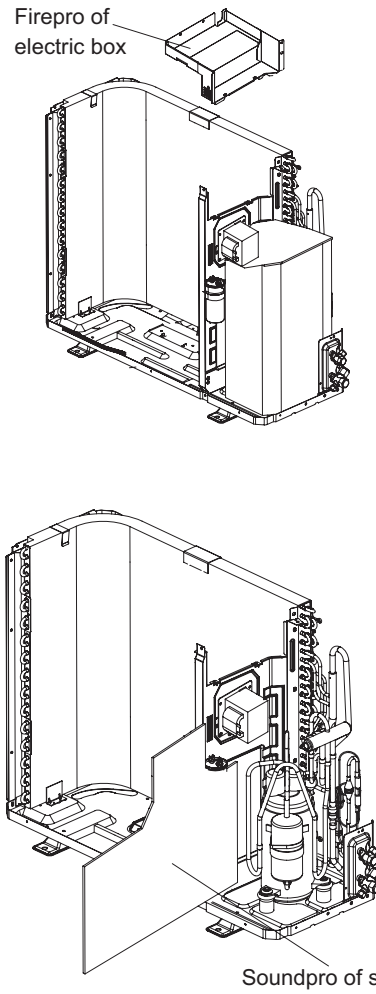
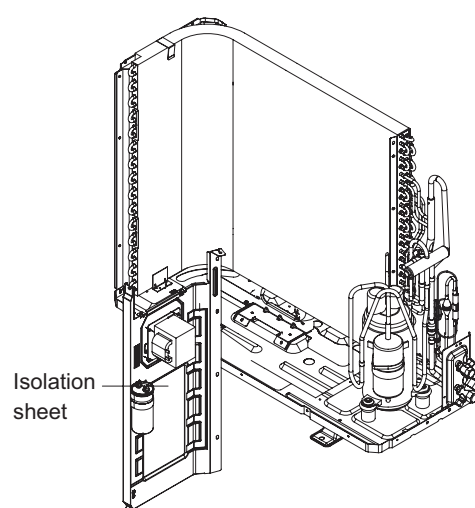

Steps	Procedure	Points
<p>6. Remove fireproof electric box and soundproof sponge</p> <p>Twist off the screws on fireproof electric box and then remove the fireproof electric box.</p>	 <p>Fireproof of electric box</p> <p>Soundproof of sponge</p>	<p>Since the piping ports on the sound blanket are torn easily, remove the blanket carefully.</p>
<p>7. Remove isolation sheet</p> <p>Remove screws fixing isolation sheet and then remove the isolation sheet.</p>	 <p>Isolation sheet</p>	





# Appendix:

## Appendix 1: Reference Sheet of Celsius and Fahrenheit

Conversion formula for Fahrenheit degree and Celsius degree:  $T_f = T_c \times 1.8 + 32$

### Set temperature

Fahrenheit display temperature (°F)	Fahrenheit (°F)	Celsius (°C)	Fahrenheit display temperature (°F)	Fahrenheit (°F)	Celsius (°C)	Fahrenheit display temperature (°F)	Fahrenheit (°F)	Celsius (°C)
61	60.8	16	69/70	69.8	21	78/79	78.8	26
62/63	62.6	17	71/72	71.6	22	80/81	80.6	27
64/65	64.4	18	73/74	73.4	23	82/83	82.4	28
66/67	66.2	19	75/76	75.2	24	84/85	84.2	29
68	68	20	77	77	25	86	86	30

### Ambient temperature

Fahrenheit display temperature (°F)	Fahrenheit (°F)	Celsius (°C)	Fahrenheit display temperature (°F)	Fahrenheit (°F)	Celsius (°C)	Fahrenheit display temperature (°F)	Fahrenheit (°F)	Celsius (°C)
32/33	32	0	55/56	55.4	13	79/80	78.8	26
34/35	33.8	1	57/58	57.2	14	81	80.6	27
36	35.6	2	59/60	59	15	82/83	82.4	28
37/38	37.4	3	61/62	60.8	16	84/85	84.2	29
39/40	39.2	4	63	62.6	17	86/87	86	30
41/42	41	5	64/65	64.4	18	88/89	87.8	31
43/44	42.8	6	66/67	66.2	19	90	89.6	32
45	44.6	7	68/69	68	20	91/92	91.4	33
46/47	46.4	8	70/71	69.8	21	93/94	93.2	34
48/49	48.2	9	72	71.6	22	95/96	95	35
50/51	50	10	73/74	73.4	23	97/98	96.8	36
52/53	51.8	11	75/76	75.2	24	99	98.6	37
54	53.6	12	77/78	77	25			

## Appendix 2: Configuration of Connection Pipe

- Standard length of connection pipe
  - 16.40ft, 24.61ft, 26.25ft.
- Min. length of connection pipe is 9.84ft.
- Max. length of connection pipe and max. high difference.
- The additional refrigerant oil and refrigerant charging required after prolonging connection pipe
  - After the length of connection pipe is prolonged for 32.81ft at the basis of standard length, you should add 5ml of refrigerant oil for each additional 16.40ft of connection pipe.
  - The calculation method of additional refrigerant charging amount (on the basis of liquid pipe):

Cooling capacity	Max length of connection pipe	Max height difference
5000 Btu/h(1465 W)	49.21ft	16.40ft
7000 Btu/h(2051 W)	49.21ft	16.40ft
9000 Btu/h(2637 W)	49.21ft	32.81ft
12000 Btu/h(3516 W)	65.62ft	32.81ft
18000 Btu/h(5274 W)	80.02ft	32.81ft
24000 Btu/h(7032 W)	80.02ft	32.81ft
28000 Btu/h(8204 W)	98.43ft	32.81ft
36000 Btu/h(10548 W)	98.43ft	65.62ft
42000 Btu/h(12306 W)	98.43ft	65.62ft
48000 Btu/h(14064 W)	98.43ft	65.62ft

- When the length of connection pipe is above 16.40ft, add refrigerant according to the prolonged length of liquid pipe. The additional refrigerant charging amount per meter is different according to the diameter of liquid pipe. See the following sheet.
- Additional refrigerant charging amount = prolonged length of liquid pipe X additional refrigerant charging amount per meter

Additional refrigerant charging amount for R22, R407C, R410A and R134a			
Diameter of connection pipe		Outdoor unit throttle	
Liquid pipe(inch)	Gas pipe(inch)	Cooling only(oz/ft.)	Cooling and heating(oz/ft.)
Φ1/4	Φ3/8or Φ1/2	0.2	0.2
Φ1/4 or Φ3/8	Φ5/8 or Φ3/4	0.2	0.2
Φ1/2	Φ3/4 or Φ7/8	0.3	1.3
Φ5/8	Φ1 or Φ1 1/4	0.7	1.3
Φ3/4	/	2.7	2.7
Φ7/8	/	3.8	3.8

## Appendix 3: Pipe Expanding Method

**Note:**

Improper pipe expanding is the main cause of refrigerant leakage. Please expand the pipe according to the following steps:

A: Cut the pip

- Confirm the pipe length according to the distance of indoor unit and outdoor unit.
- Cut the required pipe with pipe cutter.

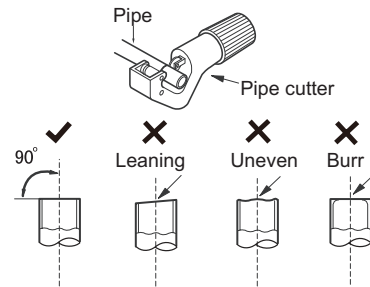

B: Remove the burrs

- Remove the burrs with shaper and prevent the burrs from getting into the pipe.

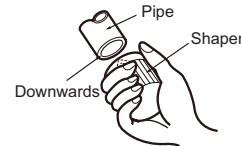

C: Put on suitable insulating pipe

D: Put on the union nut

- Remove the union nut on the indoor connection pipe and outdoor valve; install the union nut on the pipe.

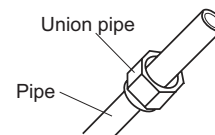

E: Expand the port

- Expand the port with expander.

**Note:**

- "A" is different according to the diameter, please refer to the sheet below:

Outer diameter(inch)	A(inch)	
	Max	Min
Φ1/4	2/39	1/36
Φ3/8	1/16	1/51
Φ1/2	1/14	1/51
Φ5/8	5/53	2/23

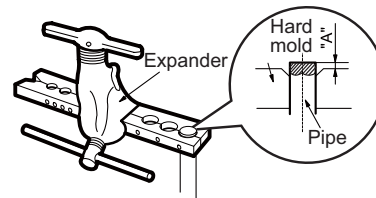

F: Inspection

- Check the quality of expanding port. If there is any blemish, expand the port again according to the steps above.

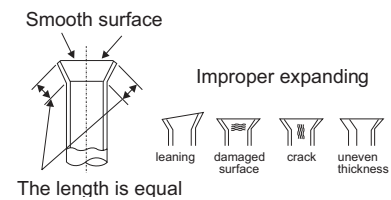

## Appendix 4: List of Resistance for Temperature Sensor

Resistance Table of Ambient Temperature Sensor for Indoor and Outdoor (15K)

Temp.(°F)	Resistance(kΩ)	Temp.(°F)	Resistance(kΩ)	Temp.(°F)	Resistance(kΩ)	Temp.(°F)	Resistance(kΩ)
-2.2	138.1	68	18.75	138.2	3.848	208.4	1.071
-0.4	128.6	69.8	17.93	140	3.711	210.2	1.039
1.4	121.6	71.6	17.14	141.8	3.579	212	1.009
3.2	115	73.4	16.39	143.6	3.454	213.8	0.98
5	108.7	75.2	15.68	145.4	3.333	215.6	0.952
6.8	102.9	77	15	147.2	3.217	217.4	0.925
8.6	97.4	78.8	14.36	149	3.105	219.2	0.898
10.4	92.22	80.6	13.74	150.8	2.998	221	0.873
12.2	87.35	82.4	13.16	152.6	2.896	222.8	0.848
14	82.75	84.2	12.6	154.4	2.797	224.6	0.825
15.8	78.43	86	12.07	156.2	2.702	226.4	0.802
17.6	74.35	87.8	11.57	158	2.611	228.2	0.779
19.4	70.5	89.6	11.09	159.8	2.523	230	0.758
21.2	66.88	91.4	10.63	161.6	2.439	231.8	0.737
23	63.46	93.2	10.2	163.4	2.358	233.6	0.717
24.8	60.23	95	9.779	165.2	2.28	235.4	0.697
26.6	57.18	96.8	9.382	167	2.206	237.2	0.678
28.4	54.31	98.6	9.003	168.8	2.133	239	0.66
30.2	51.59	100.4	8.642	170.6	2.064	240.8	0.642
32	49.02	102.2	8.297	172.4	1.997	242.6	0.625
33.8	46.6	104	7.967	174.2	1.933	244.4	0.608
35.6	44.31	105.8	7.653	176	1.871	246.2	0.592
37.4	42.14	107.6	7.352	177.8	1.811	248	0.577
39.2	40.09	109.4	7.065	179.6	1.754	249.8	0.561
41	38.15	111.2	6.791	181.4	1.699	251.6	0.547
42.8	36.32	113	6.529	183.2	1.645	253.4	0.532
44.6	34.58	114.8	6.278	185	1.594	255.2	0.519
46.4	32.94	116.6	6.038	186.8	1.544	257	0.505
48.2	31.38	118.4	5.809	188.6	1.497	258.8	0.492
50	29.9	120.2	5.589	190.4	1.451	260.6	0.48
51.8	28.51	122	5.379	192.2	1.408	262.4	0.467
53.6	27.18	123.8	5.197	194	1.363	264.2	0.456
55.4	25.92	125.6	4.986	195.8	1.322	266	0.444
57.2	24.73	127.4	4.802	197.6	1.282	267.8	0.433
59	23.6	129.2	4.625	199.4	1.244	269.6	0.422
60.8	22.53	131	4.456	201.2	1.207	271.4	0.412
62.6	21.51	132.8	4.294	203	1.171	273.2	0.401
64.4	20.54	134.6	4.139	204.8	1.136	275	0.391
66.2	19.63	136.4	3.99	206.6	1.103	276.8	0.382

Resistance Table of Tube Temperature Sensors for Indoor and Outdoor (20K)

Temp.(°F)	Resistance(kΩ)	Temp.(°F)	Resistance(kΩ)	Temp.(°F)	Resistance(kΩ)	Temp.(°F)	Resistance(kΩ)
-2.2	181.4	68	25.01	138.2	5.13	208.4	1.427
-0.4	171.4	69.8	23.9	140	4.948	210.2	1.386
1.4	162.1	71.6	22.85	141.8	4.773	212	1.346
3.2	153.3	73.4	21.85	143.6	4.605	213.8	1.307
5	145	75.2	20.9	145.4	4.443	215.6	1.269
6.8	137.2	77	20	147.2	4.289	217.4	1.233
8.6	129.9	78.8	19.14	149	4.14	219.2	1.198
10.4	123	80.6	18.13	150.8	3.998	221	1.164
12.2	116.5	82.4	17.55	152.6	3.861	222.8	1.131
14	110.3	84.2	16.8	154.4	3.729	224.6	1.099
15.8	104.6	86	16.1	156.2	3.603	226.4	1.069
17.6	99.13	87.8	15.43	158	3.481	228.2	1.039
19.4	94	89.6	14.79	159.8	3.364	230	1.01
21.2	89.17	91.4	14.18	161.6	3.252	231.8	0.983
23	84.61	93.2	13.59	163.4	3.144	233.6	0.956
24.8	80.31	95	13.04	165.2	3.04	235.4	0.93
26.6	76.24	96.8	12.51	167	2.94	237.2	0.904
28.4	72.41	98.6	12	168.8	2.844	239	0.88
30.2	68.79	100.4	11.52	170.6	2.752	240.8	0.856
32	65.37	102.2	11.06	172.4	2.663	242.6	0.833
33.8	62.13	104	10.62	174.2	2.577	244.4	0.811
35.6	59.08	105.8	10.2	176	2.495	246.2	0.777
37.4	56.19	107.6	9.803	177.8	2.415	248	0.769
39.2	53.46	109.4	9.42	179.6	2.339	249.8	0.746
41	50.87	111.2	9.054	181.4	2.265	251.6	0.729
42.8	48.42	113	8.705	183.2	2.194	253.4	0.71
44.6	46.11	114.8	8.37	185	2.125	255.2	0.692
46.4	43.92	116.6	8.051	186.8	2.059	257	0.674
48.2	41.84	118.4	7.745	188.6	1.996	258.8	0.658
50	39.87	120.2	7.453	190.4	1.934	260.6	0.64
51.8	38.01	122	7.173	192.2	1.875	262.4	0.623
53.6	36.24	123.8	6.905	194	1.818	264.2	0.607
55.4	34.57	125.6	6.648	195.8	1.736	266	0.592
57.2	32.98	127.4	6.403	197.6	1.71	267.8	0.577
59	31.47	129.2	6.167	199.4	1.658	269.6	0.563
60.8	30.04	131	5.942	201.2	1.609	271.4	0.549
62.6	28.68	132.8	5.726	203	1.561	273.2	0.535
64.4	27.39	134.6	5.519	204.8	1.515	275	0.521
66.2	26.17	136.4	5.32	206.6	1.47	276.8	0.509





F R I E D R I C H

JF00302173