

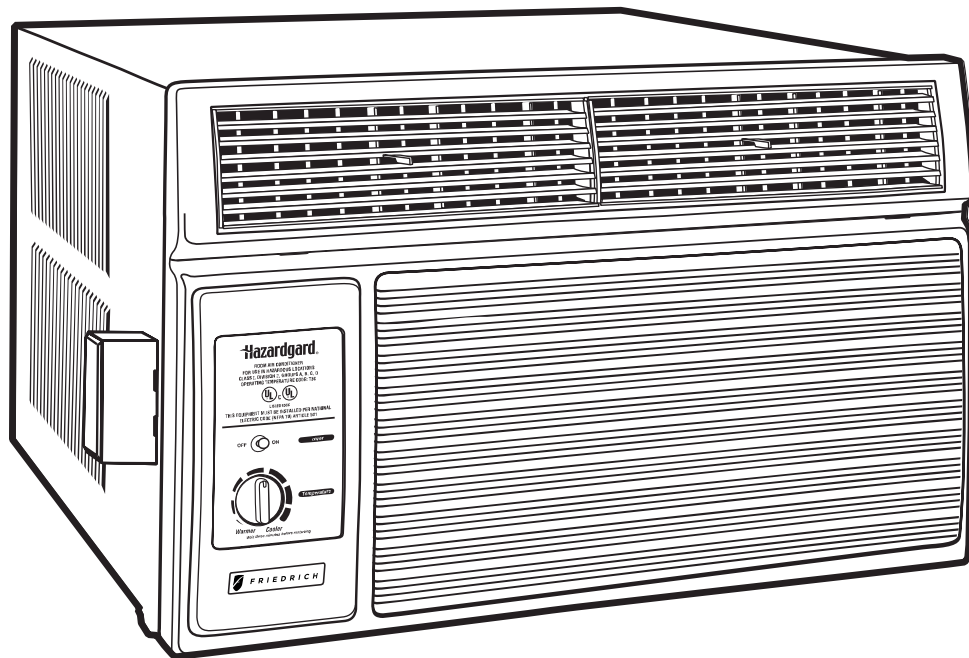

F R I E D R I C H

2011

Hazardous Duty Room Air Conditioner



Hazardgard® R-410A Models

Cool Only
SH15M30*
SH20M30*

Table Of Contents

Important Safety Information	2-4
Introduction	4
Unit Identification	5
Hazardgard Application	6
Performance Specifications and Installation Data	7
Electrical Data	8
Hazardgard Special Features	9
Component Definitions	10
Component Testing	11-12
R-410A Sealed System Repair Considerations	13
Sealed Refrigeration System Repairs	14-17
Refrigerant Charging	14-17
Compressor Checks	18-19
Compressor Replacement	19-20
Routine Maintenance	21-22
Performance Test Data Sheet	23
Troubleshooting	24-26
Wiring Diagram and Schematic	27
Warranty	28
Technical Assistance	29

IMPORTANT SAFETY INFORMATION

The information contained in this manual is intended for use by a qualified service technician who is familiar with the safety procedures required for installation and repair, and who is equipped with the proper tools and test instruments required to service this product.

Installation or repairs made by unqualified persons can result in subjecting the unqualified person making such repairs as well as the persons being served by the equipment to hazards resulting in injury or electrical shock which can be serious or even fatal.

Safety warnings have been placed throughout this manual to alert you to potential hazards that may be encountered. If you install or perform service on equipment, it is your responsibility to read and obey these warnings to guard against any bodily injury or property damage which may result to you or others.

Your safety and the safety of others are very important.

We have provided many important safety messages in this manual and on your appliance. Always read and obey all safety messages.



This is a safety Alert symbol.

This symbol alerts you to potential hazards that can kill or hurt you and others.

All safety messages will follow the safety alert symbol with the word "WARNING" or "CAUTION". These words mean:



You can be killed or seriously injured if you do not follow instructions.



You can receive minor or moderate injury if you do not follow instructions.

All safety messages will tell you what the potential hazard is, tell you how to reduce the chance of injury, and tell you what will happen if the instructions are not followed.



A message to alert you of potential property damage will have the word "NOTICE". Potential property damage can occur if instructions are not followed.

PERSONAL INJURY OR DEATH HAZARDS

ELECTRICAL HAZARDS:

- Unplug and/or disconnect all electrical power to the unit before performing inspections, maintenance, or service.
- Make sure to follow proper lockout/tag out procedures.
- Always work in the company of a qualified assistant if possible.
- Capacitors, even when disconnected from the electrical power source, retain an electrical charge potential capable of causing electric shock or electrocution.
- Handle, discharge, and test capacitors according to safe, established, standards, and approved procedures.
- Extreme care, proper judgment, and safety procedures must be exercised if it becomes necessary to test or troubleshoot equipment with the power on to the unit.

- Do not spray or pour water on the return air grille, discharge air grille, evaporator coil, control panel, and sleeve on the room side of the air conditioning unit while cleaning.
- Electrical component malfunction caused by water could result in electric shock or other electrically unsafe conditions when the power is restored and the unit is turned on, even after the exterior is dry.
- Never operate the A/C unit with wet hands.
- Use air conditioner on a single dedicated circuit within the specified amperage rating.
- Use on a properly grounded circuit only.
- Do not use extension cords with the unit.
- Follow all safety precautions and use proper and adequate protective safety aids such as: gloves, goggles, clothing, adequately insulated tools, and testing equipment etc.
- Failure to follow proper safety procedures and/or these warnings can result in serious injury or death.

REFRIGERATION SYSTEM HAZARDS:

- Use approved standard refrigerant recovering procedures and equipment to relieve pressure before opening system for repair.
- Do not allow liquid refrigerant to contact skin. Direct contact with liquid refrigerant can result in minor to moderate injury.
- Be extremely careful when using an oxy-acetylene torch. Direct contact with the torch's flame or hot surfaces can cause serious burns.
- Make sure to protect personal and surrounding property with fire proof materials.
- Have a fire extinguisher at hand while using a torch.
- Provide adequate ventilation to vent off toxic fumes, and work with a qualified assistant whenever possible.
- Always use a pressure regulator when using dry nitrogen to test the sealed refrigeration system for leaks, flushing etc.
- Make sure to follow all safety precautions and to use proper protective safety aids such as: gloves, safety glasses, clothing etc.
- Failure to follow proper safety procedures and/or these warnings can result in serious injury or death.

MECHANICAL HAZARDS:

- Extreme care, proper judgment and all safety procedures must be followed when testing, troubleshooting, handling, or working around unit with moving and/or rotating parts.
- Be careful when, handling and working around exposed edges and corners of sleeve, chassis, and other unit components especially the sharp fins of the indoor and outdoor coils.
- Use proper and adequate protective aids such as: gloves, clothing, safety glasses etc.
- Failure to follow proper safety procedures and/or these warnings can result in serious injury or death.

PROPERTY DAMAGE HAZARDS

FIRE DAMAGE HAZARDS:

- Read the Installation/Operation Manual for this air conditioning unit prior to operating.
- Use air conditioner on a single dedicated circuit within the specified amperage rating.
- Connect to a properly grounded circuit only.
- Do not use extension cords with the unit.
- Failure to follow these instructions can result in fire and minor to serious property damage.

WATER DAMAGE HAZARDS:

- Improper installation maintenance, or servicing of the air conditioner unit, or not following the above Safety Warnings can result in water damage to personal items or property.
- Insure that the unit has a sufficient pitch to the outside to allow water to drain from the unit.
- Do not drill holes in the bottom of the drain pan or the underside of the unit.
- Failure to follow these instructions can result in result in damage to the unit and/or minor to serious property damage.

INTRODUCTION

This service manual is designed to be used in conjunction with the operation and installation manual provided with each unit.

This service manual was written to assist the professional HVAC service technician to quickly and accurately diagnose and repair any malfunctions of this product.

This manual, therefore, will deal with all subjects in a general nature. (i.e. All text will pertain to all models).

IMPORTANT: It will be necessary for you to accurately identify the unit you are servicing, so you can be certain of a proper diagnosis and repair. (See Unit Identification.)

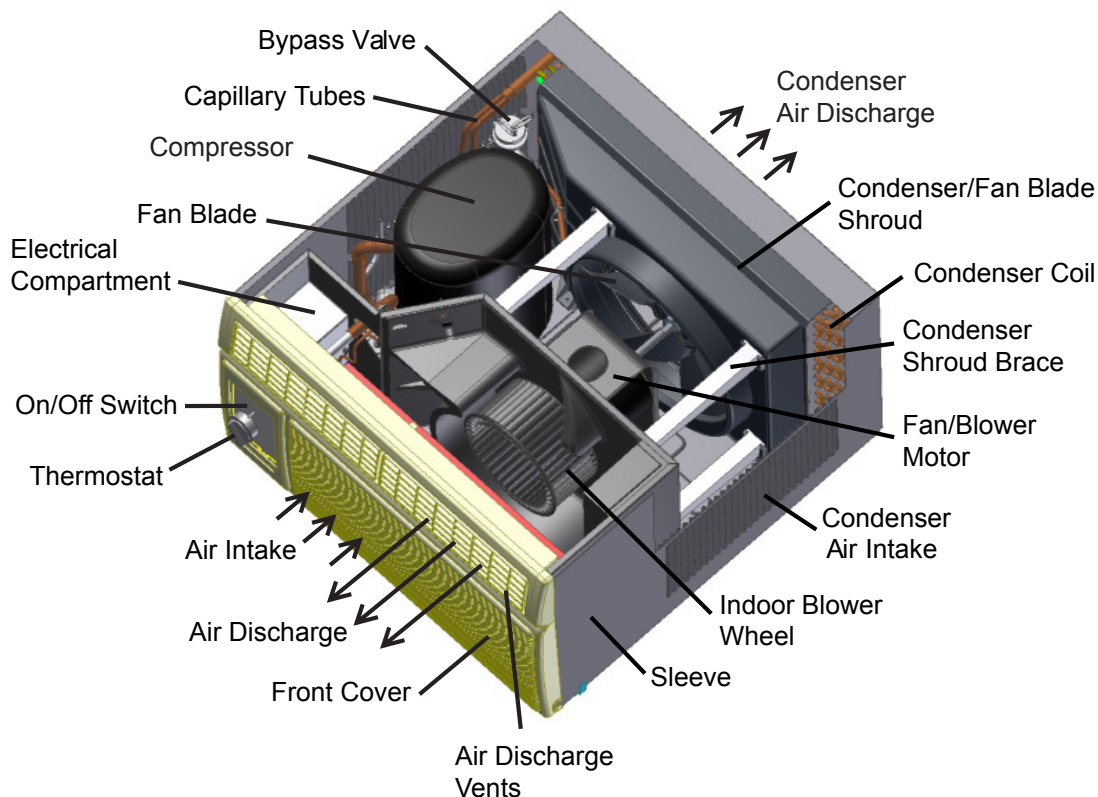

UNIT IDENTIFICATION

Model Number Code

S H 15 M 3 0 A - A

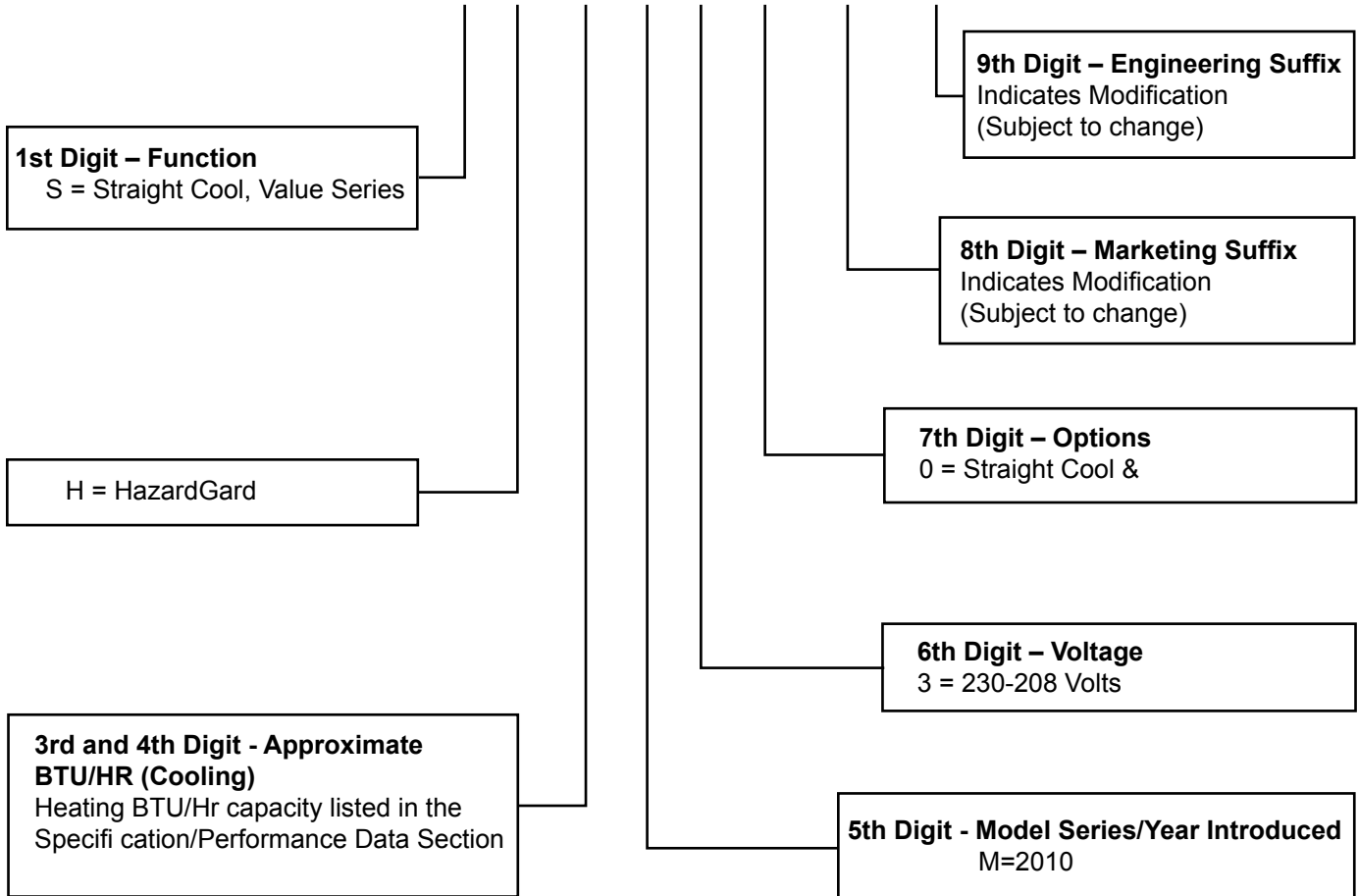

RAC Serial Number Identification Guide

Serial Number Decade Manufactured L=0 C=3 F=6 J=9 A=1 D=4 G=7 B=2 E=5 H=8	A	A	A	R	0001 Production Run Number
Year Manufactured A=1 D=4 G=7 K=0 B=2 E=5 H=8 C=3 F=6 J=9					Product Line R = RAC
Month Manufactured A=Jan D=Apr G=Jul K=Oct B=Feb E=May H=Aug L=Nov C=Mar F=Jun J=Sept M=Dec					

HAZARDGARD APPLICATION

UL Listed for use in Class I, Division 2, Groups A, B, C and D hazardous locations.

Hazardgard is specifically designed to cool living quarters, storage areas and other enclosures situated in hazardous locations, where specific volatile flammable liquids or gases are handled or used within enclosed containers or systems.

For more than 30 years, the Friedrich Hazardgard has endured some of the toughest and most unforgiving operating conditions imaginable. Time-tested in the field where it counts, Hazardgard is trusted by professionals who have to get the job done. Robust engineering with design details like 33% thicker fins extend the life of the coil. Diamonblue Technology, our anti-corrosive treatment, provides added endurance and protection in coastal or corrosive environments.



Ideal applications

Offshore oil rigs, on-shore oil company offices and refineries

Petrochemical sites and propane fill-up stations

Paint and varnish storage or processing plants

Grain alcohol processors or storage sites

Plant areas using strong solvents or chemicals

Munitions plants or armories

PVC or plastics plants and processing points

Recycling plants

Furniture refinishing/stripping workshops

Fertilizer plants

Office complexes where methane is a by-product

Hazardous materials storage



SPECIFICATIONS AND PERFORMANCE DATA

Cooling Performance Data *

	EVAPORATOR AIR TEMP. DEG. F		CONDENSER TEMPERATURE DEG. F	Discharge Temp	Suction Temp	Super Heat	Sub-Cooling	OPERATING PRESSURES		ELECTRICAL RATINGS			R-410A REF. Charge in OZ.	Voltage	BREAKER FUSE 60 Hertz Amps
	Discharge Air	Temp. Drop F.						Suction	Discharge	Amps Cool	Amps Heat	Locked Rotor Amps			
SH15M30*	54	26	127	186	67	18	35	137	480	6.9	-	43	50	208 / 230	15
SH15M30*	54	26	185	124	68	15	38	137	485	9.1	-	43	42.7	208 / 230	15

* Due to continuing research in new energy-saving technology, performance data and 8th and 9th character are subject to change without notice.

Specifications

Model	Cooling Capacity (BTU/Hr.- AHAM)	Electrical Characteristics (60 Hertz)			Energy Efficiency Ratio AHAM EER	Moisture Removal (Pints/ Hr.)	Air Direction Controls	Room Side Air Circulation CFM
		Volts Rated	Amps AHAM	Watts				
SH15M30*	14500/14000	230/208	6.9/7.4	1495/1443	9.7/9.7	6.0	8-way	375
SH20M30*	19500/19000	230/208	9.1/10.0	2074/2021	9.4/9.4	4.0	8-way	375

Installation Information

Model	Dimensions (Inches)						Window Width (Inches)		Thru-The-Wall Finished Hole (Inches)			Circuit Rating Breaker or T - D Fuse Volts - Amps	Weight (Lbs.)	
	Height	Width	Depth Overall A	Depth J Box to Louvers B	Minimum Extension Into Room	Minimum Extension Outside	Min.	Max.	Height	Width	Max. Depth C		Net	Shipping
SH15M30*	15 15/16	25 15/16	27 3/8	6	3 1/16	16 15/16	27 7/8	42	16 3/16	26 3/16	6	250V - 15A	156	168
SH20M30*	17 15/16	25 15/16	27 3/8	6	3 1/16	16 15/16	27 7/8	42	18 3/16	26 3/16	6	250V - 15A	160	174

Due to continuing engineering research and technology, specifications are subject to change without notice. Manufactured under U.S. Design Patent DES 368, 306 decorative front; Utility Patent 5, 622, 058. MAXIMUM outdoor ambient operating temperature is 130°F. MAXIMUM TEMPERATURE RATING FOR CLASS I, DIVISION 2, GROUPS A,B,C,D.

OPERATING TEMPERATURE CODE T3B



STANDARD ON ALL MODELS.
This advanced corrosion protection treatment protects the outdoor coil against deterioration and extends the life of the unit especially in harsh coastal environments.

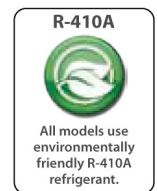
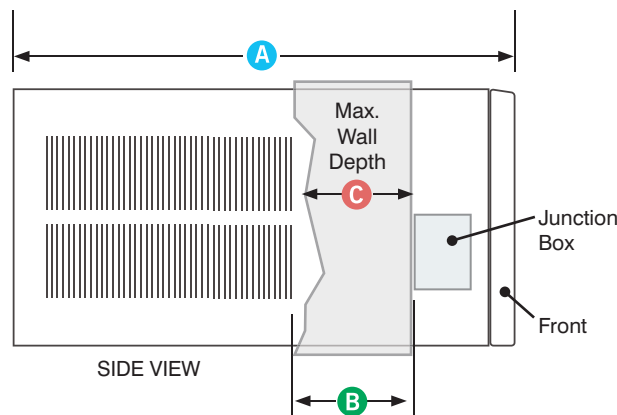

ELECTRICAL DATA

⚠ WARNING	
	ELECTRIC SHOCK HAZARD Turn off electric power before service or installation.
	All electrical connections and wiring MUST be installed by a qualified electrician and conform to the National Electrical Code and all local codes which have jurisdiction.
	Failure to do so can result in personal injury or death.

NOTICE
FIRE HAZARD Not following the above WARNING could result in fire or electrically unsafe conditions which could cause moderate or serious property damage. Read, understand and follow the above warning.

ELECTRICAL REQUIREMENTS

ALL FIELD WIRING MUST MEET THE REQUIREMENTS OF THE NATIONAL ELECTRICAL CODE (ANSI/NFPA 70) ARTICLE 501.

THE FIELD-PROVIDED CIRCUIT PROTECTION DEVICE (HACR CIRCUIT BREAKER OR TIME DELAY FUSE) MUST NOT EXCEED THE AMPACITY INDICATED ON THE PRODUCT NAMEPLATE.

IMPORTANT: Before you begin the actual installation of your air conditioner, check local electrical codes and the information below.

Your air conditioner must be connected to a power supply with the same A.C. voltage and frequency (hertz) as marked on the data plate located on the chassis. Only alternating current (A.C.), no direct current (D.C.), can be used.

An overloaded circuit will invariably cause malfunction or failure of the air conditioner therefore, it is extremely important that the electrical power is adequate. Consult your power company if in doubt.

Model Number	Connection Type	Circuit Rating Time Delay Fuse
SH15	Junction Box	250V-15 Amp
SH20	Junction Box	250V-15 Amp

HAZARDGARD SPECIAL FEATURES

- Permanent Split-Capacitor, totally enclosed fan motor to assure efficient operation even under adverse electrical conditions. Motor has a special stainless steel shaft to resist corrosion and a hermetically sealed overload for arc-free operation.
- High capacity compressor with internal hermetically sealed overload.
- Solid-state relay contains transient voltage suppressor to protect controls against transient voltage spikes. Provides solid state switches for arc-free operation.
- Hot gas bypass low ambient control to permit operation without freezing at outdoor ambient temperatures as low as 45°F (7°C).
- Environmentally sealed on-off switch and gold plated contacts in thermostat for corrosion resistance.
- Electrodeposited epoxy primer and alkyd enamel, both oven-baked for an attractive, long-lasting finish.
- Copper tubing/aluminum fin coils.
- Galvanized steel cabinet and base pan, all bonderized.
- Slide-out chassis for easy installation in window or through-the-wall.
- Extra insulation inside, including completely insulated plenum chamber for quieter, more efficient cooling.
- Entire unit test run in environmental chamber before crating.
- Eight-way air flow control for uniform air circulation.
- Condensate drain with exclusive mosquito trap.
- 15 amp circuit with time-delay fuse required. Accommodates direct wiring.
- Long lasting 3/8" (10mm) thick air filter, germicidally treated, easily removed for cleaning.

Friedrich Air Conditioning quality has been proven by more than 25 years of successful experience from the Gulf of Mexico to the searing sands of the Arabian desert.

Control Panel

Function Control (Power)

This switch is a double pole, single throw toggle switch.

ON - Turns everything on.

(Fan motor runs continuously)

OFF - Turns everything off.

Temperature Control

The knob at the bottom is the thermostat which is a cross ambient type used to maintain the desired comfort level. The thermostat reacts only to a change in temperature at the bulb location - turn the knob clockwise to set cooler, counterclockwise for warmer.

Exclusive

Friedrich leads with the first UL Listed Room Air Conditioners designed to cool living quarters and other enclosures situated in hazardous locations where specific volatile flammable liquids or gases are handled or used with enclosed containers or systems. **Friedrich Hazardgard room air conditioners are designed to meet the National Electrical Code, Article 500 requirements for Class I, Division 2, Groups A, B, C, D Hazardous locations, and are the only air conditioners UL Listed for this application. THIS UNIT IS LISTED BY UNDERWRITERS LABORATORIES FOR USE IN CLASS I, DIVISION 2, GROUPS A, B, C, D HAZARDOUS LOCATIONS. Operating Temperature Code: T3B.**

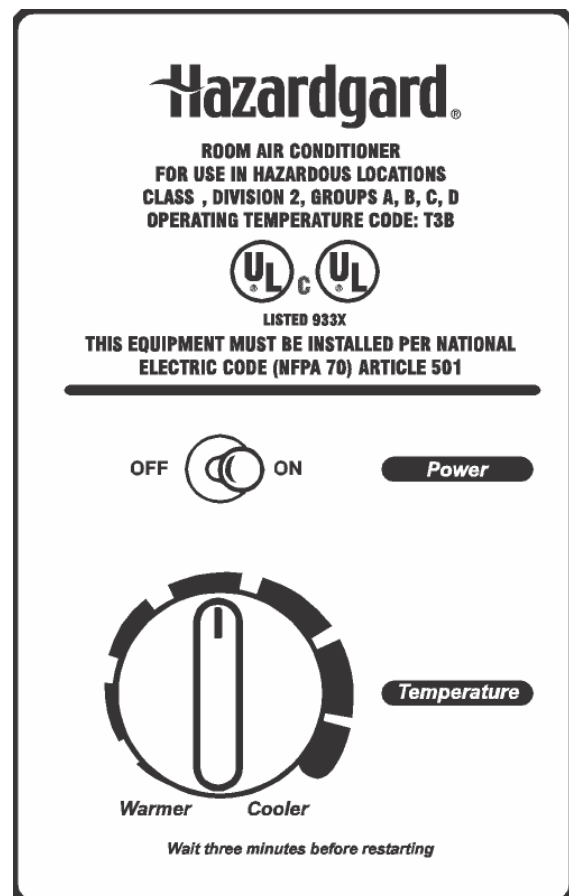

COMPONENT DEFINITIONS

A. Mechanical components

Plenum assembly

Diffuser with directional louvers used to direct the conditioned airflow.

Blower wheel

Attaches to the indoor side of the fan motor shaft and is used for distributing unconditioned, room side air through the heat exchanger and delivering conditioned air into the room.

Slinger fan blade

Attaches to the outdoor side of the fan motor shaft and is used to move outside air through the condenser coil, while slinging condensate water out of the base pan and onto the condenser coil, thus lowering the temperature and pressures within the coil.

B. Electrical components

Thermostat Control

Used to maintain the specified room side comfort level.

System Switch

Used to regulate the operation of the fan motor and the compressor or to turn the unit off. For troubleshooting, refer to the wiring diagrams and schematics in the back of this service manual.

Solid State Relay

Used to energize the compressor and fan motor. Each unit has 2, 50 amp, 208/230 volt relays.

Capacitor

Reduces line current and steadies the voltage supply, while greatly improving the torque characteristics of the fan motor and compressor motor.

Fan Motor

Dual shafted fan motor operates the indoor blower wheel and the condenser fan blade simultaneously. (When unit is turned on, the fan motor runs continuously).

C. Hermetic components

Compressor

Motorized device used to compress refrigerant through the sealed system.

Low ambient bypass (hot gas bypass) valve

Used for low ambient cooling operation, the valve is connected between the discharge line at the compressor and the suction process tube. It responds to suction pressure, which when reduced in the system, causes the valve to open and bypass hot gas from the high pressure side to the low pressure side of the system. The valve is preset to open when the suction pressure reaches 88 psig.

Capillary tube

A cylindrical metering device used to evenly distribute the flow of refrigerant to the heat exchanger (evaporator coils).

COMPONENT TESTING

FAN MOTOR

A 230 volt single phase permanent split capacitor motor is used to drive the evaporator blower and condenser fan. A running capacitor is wired across the start and run terminals of the motor.

The motor is totally enclosed and is protected with a line voltage overload located internally of the motor. The motor shaft is stainless steel to resist corrosion. When the unit is turned on, the motor runs continuously.

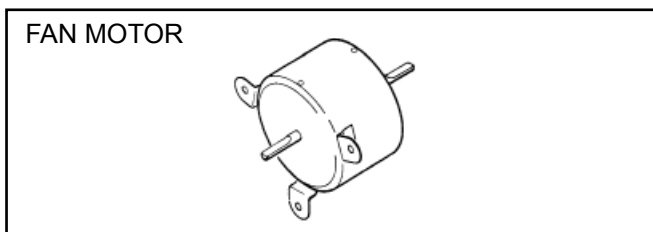

⚠ WARNING	
	ELECTRIC SHOCK HAZARD Disconnect power to the unit before servicing. Failure to follow this warning could result in serious injury or death.

FAN MOTOR – TEST

1. Determine that the capacitor is good.
2. Perform continuity test on windings to determine if open, shorted or okay.

SOLID STATE RELAY

Two 50 amp rated 208/230 volt solid state relays are used to energize the compressor and fan motor. Terminals 3 and 4 are the 208/230 volt line side. Terminals 1 and 2 are load side contacts.

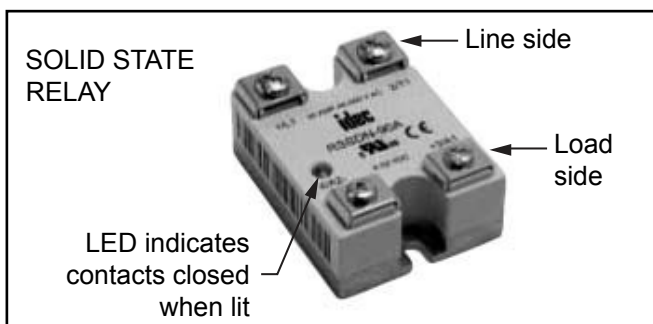

SYSTEM CONTROL SWITCH

This switch is double pole, single throw. Check for continuity between terminals 2 and 3, and 5 and 6.

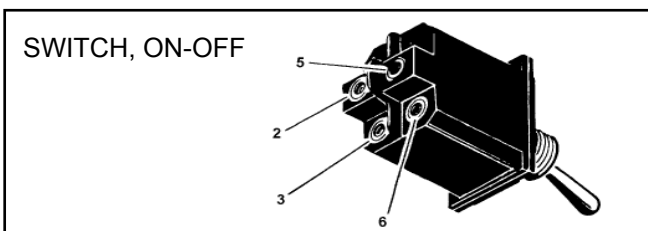

CAPACITORS

⚠ WARNING	
	ELECTRIC SHOCK HAZARD Turn off electric power before servicing. Discharge capacitor with a 20,000 Ohm 2 Watt resistor before handling. Failure to do so may result in personal injury, or death.

Many motor capacitors are internally fused. Shorting the terminals will blow the fuse, ruining the capacitor. A 20,000 ohm 2 watt resistor can be used to discharge capacitors safely. Remove wires from capacitor and place resistor across terminals. When checking a dual capacitor with a capacitor analyzer or ohmmeter, both sides must be tested.

Capacitor Check with Capacitor Analyzer

The capacitor analyzer will show whether the capacitor is “open” or “shorted.” It will tell whether the capacitor is within its micro farads rating and it will show whether the capacitor is operating at the proper power-factor percentage. The instrument will automatically discharge the capacitor when the test switch is released.

Capacitor Connections

The starting winding of a motor can be damaged by a shorted and grounded running capacitor. This damage usually can be avoided by proper connection of the running capacitor terminals.

From the supply line on a typical 230 volt circuit, a 115 volt potential exists from the “R” terminal to ground through a possible short in the capacitor. However, from the “S” or start terminal, a much higher potential, possibly as high as 400 volts, exists because of the counter EMF generated in the start winding. Therefore, the possibility of capacitor failure is much greater when the identified terminal is connected to the “S” or start terminal. The identified terminal should always be connected to the supply line, or “R” terminal, never to the “S” terminal.

When connected properly, a shorted or grounded running capacitor will result in a direct short to ground from the “R” terminal and will blow the line fuse. The motor protector will protect the main winding from excessive temperature.

THERMOSTAT

A cross ambient thermostat is used to maintain the desired comfort level. The thermostat reacts only to a change in temperature at the bulb location. Important to the successful operation of the unit is the position of the sensing bulb in relation to the evaporator.

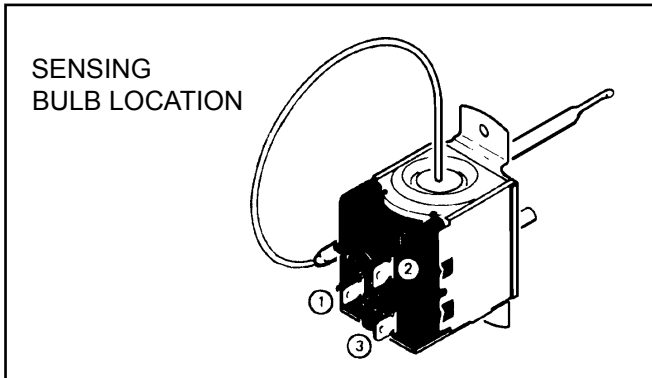

RANGE: Thermostat
(Part No. 618-225-02)
60° F (± 2°) to 90° F (± 4°)

⚠ WARNING



ELECTRIC SHOCK HAZARD

Disconnect power to the unit before servicing. Failure to follow this warning could result in serious injury or death.

TESTING THE THERMOSTAT

Remove the wires from the thermostat. Turn the thermostat to its coldest position. Check to see if there is continuity between the two terminals. Turn the thermostat to its warmest position. Check continuity to see if the thermostat contacts open.

Note: The temperature must be within the range listed to check the thermostat. Refer to the troubleshooting section in this manual for additional information on thermostat testing.

LOW AMBIENT BYPASS VALVE

⚠ WARNING

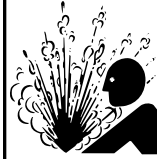

HIGH PRESSURE HAZARD

Sealed Refrigeration System contains refrigerant and oil under high pressure.

Proper safety procedures must be followed, and proper protective clothing must be worn when working with refrigerants.

Failure to follow these procedures could result in serious injury or death.

The Hazardgard unit is designed to operate at low outside ambient temperatures. This is accomplished by the use of a bypass valve installed in the refrigeration circuit. The valve is connected between the discharge line at the compressor and the suction process tube. The valve responds to suction pressure which, when reduced in the system, causes the valve to open and bypass hot gas from the high pressure side to the low pressure side of the system. The hot gas entering the compressor mixes with the cool gas returned through the suction line, thus increasing the suction pressure. The valve is preset to open when the suction pressure reaches 88 psig. This pressure setting cannot be altered. The system can be operated at outdoor temperatures as low as 45°F before the evaporator coil will begin to accumulate frost.

To determine if the valve operates, block the return air to the evaporator coil. Turn on the unit and touch the tube at the bypass valve outlet which connects to the suction process tube. When the low side pressure reaches approximately 88 psig, the valve will begin to open and the tube will get hot. This method will determine if the valve is responding to the suction pressure change.

LOW AMBIENT BYPASS VALVE

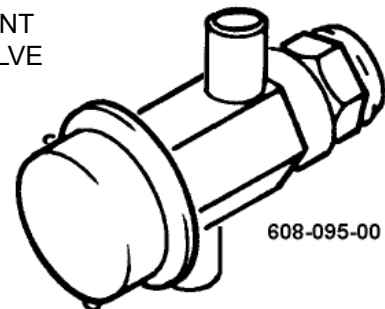

608-095-00

R-410A SEALED SYSTEM REPAIR CONSIDERATIONS

⚠ WARNING	
	<p>Refrigeration system under high pressure</p> <p>Do not puncture, heat, expose to flame or incinerate.</p> <p>Only certified refrigeration technicians should service this equipment.</p> <p>R410A systems operate at higher pressures than R22 equipment. Appropriate safe service and handling practices must be used.</p> <p>Only use gauge sets designed for use with R410A. Do not use standard R22 gauge sets.</p>

The following is a list of important considerations when working with R-410A equipment

- R-410A pressure is approximately 60% higher than R-22 pressure.
- R-410A cylinders must not be allowed to exceed 125 F, they may leak or rupture.
- R-410A must never be pressurized with a mixture of air, it may become flammable.
- Servicing equipment and components must be specifically designed for use with R-410A and dedicated to prevent contamination.
- Manifold sets must be equipped with gauges capable of reading 750 psig (high side) and 200 psig (low side), with a 500-psig low-side retard.
- Gauge hoses must have a minimum 750-psig service pressure rating
- Recovery cylinders must have a minimum service pressure rating of 400 psig, (DOT 4BA400 and DOT BW400 approved cylinders).
- POE (Polyol-Ester) lubricants must be used with R-410A equipment.
- To prevent moisture absorption and lubricant contamination, do not leave the refrigeration system open to the atmosphere longer than 1 hour.
- Weigh-in the refrigerant charge into the high side of the system.
- Introduce liquid refrigerant charge into the high side of the system.
- For low side pressure charging of R-410A, use a charging adaptor.
- Use Friedrich approved R-410A filter dryers only.

R-410A SEALED REFRIGERATION SYSTEM REPAIRS

IMPORTANT

SEALED SYSTEM REPAIRS TO COOL-ONLY MODELS REQUIRE THE INSTALLATION OF A LIQUID LINE DRIER.

EQUIPMENT REQUIRED:

1. Voltmeter
2. Ammeter
3. Ohmmeter
4. E.P.A. Approved Refrigerant Recovery System
5. Vacuum Pump (capable of 200 microns or less vacuum.)
6. Acetylene Welder
7. Electronic Halogen Leak Detector capable of detecting HFC (Hydrofluorocarbon) refrigerants.
8. Accurate refrigerant charge measuring device such as:
 - a. Balance Scales - 1/2 oz. accuracy
 - b. Charging Board - 1/2 oz. accuracy
9. High Pressure Gauge - (0 to 750 lbs.)
10. Low Pressure Gauge - (-30 to 200 lbs.)
11. Vacuum Gauge - (0 - 1000 microns)
12. Facilities for flowing nitrogen through refrigeration tubing during all brazing processes.

EQUIPMENT MUST BE CAPABLE OF:

1. Recovering refrigerant to EPA required levels.
2. Evacuation from both the high side and low side of the system simultaneously.
3. Introducing refrigerant charge into high side of the system.
4. Accurately weighing the refrigerant charge introduced into the system.

WARNING



RISK OF ELECTRIC SHOCK

Unplug and/or disconnect all electrical power to the unit before performing inspections, maintenances or service.

Failure to do so could result in electric shock, serious injury or death.

WARNING



HIGH PRESSURE HAZARD

Sealed Refrigeration System contains refrigerant and oil under high pressure.

Proper safety procedures must be followed, and proper protective clothing must be worn when working with refrigerants.

Failure to follow these procedures could result in serious injury or death.

Proper refrigerant charge is essential to proper unit operation. Operating a unit with an improper refrigerant charge will result in reduced performance (capacity) and/or efficiency. Accordingly, the use of proper charging methods during servicing will insure that the unit is functioning as designed and that its compressor will not be damaged.

Too much refrigerant (overcharge) in the system is just as bad (if not worse) than not enough refrigerant (undercharge). They both can be the source of certain compressor failures if they remain uncorrected for any period of time. Quite often, other problems (such as low air flow across evaporator, etc.) are misdiagnosed as refrigerant charge problems. The refrigerant circuit diagnosis chart will assist you in properly diagnosing these systems.

An overcharged unit will at times return liquid refrigerant (slugging) back to the suction side of the compressor eventually causing a mechanical failure within the compressor. This mechanical failure can manifest itself as valve failure, bearing failure, and/or other mechanical failure. The specific type of failure will be influenced by the amount of liquid being returned, and the length of time the slugging continues.

Not enough refrigerant (undercharge) on the other hand, will cause the temperature of the suction gas to increase to the point where it does not provide sufficient cooling for the compressor motor. When this occurs, the motor winding temperature will increase causing the motor to overheat and possibly cycle open the compressor overload protector. Continued overheating of the motor windings and/or cycling of the overload will eventually lead to compressor motor or overload failure.

Refrigerant Charging

NOTE: Because the Hazardgard refrigeration system is sealed, service process tubes will have to be installed. First install a line tap and remove refrigerant from the system. Make necessary sealed system repairs and vacuum system. Crimp process tube line and solder end shut. Do not leave a service valve in the sealed system.

Method Of Charging / Repairs

The acceptable method for charging the Hazardgard system is the Weighed in Charge Method. The weighed in charge method is applicable to all units. It is the preferred method to use, as it is the most accurate.

The weighed in method should always be used whenever a charge is removed from a unit such as for a leak repair, compressor replacement, or when there is no refrigerant charge left in the unit. To charge by this method, requires the following steps:

1. Install a piercing valve to remove refrigerant from the sealed system. (Piercing valve must be removed from the system before recharging.)
2. Recover Refrigerant in accordance with EPA regulations.

⚠ WARNING	
	BURN HAZARD Proper safety procedures must be followed, and proper protective clothing must be worn when working with a torch. Failure to follow these procedures could result in moderate or serious injury.

3. Install a process tube to sealed system.

⚠ CAUTION	
	FREEZE HAZARD Proper safety procedures must be followed, and proper protective clothing must be worn when working with liquid refrigerant. Failure to follow these procedures could result in minor to moderate injury.

4. Make necessary repairs to system.
5. Evacuate system to 200 microns or less.
6. Weigh in refrigerant with the proper quantity of R-410A refrigerant.
7. Start unit, and verify performance.

⚠ WARNING	
	BURN HAZARD Proper safety procedures must be followed, and proper protective clothing must be worn when working with a torch. Failure to follow these procedures could result in moderate or serious injury.

8. Crimp the process tube and solder the end shut.

⚠ WARNING



ELECTRIC SHOCK HAZARD

Turn off electric power before service or installation.

Extreme care must be used, if it becomes necessary to work on equipment with power applied.

Failure to do so could result in serious injury or death.

⚠ WARNING



HIGH PRESSURE HAZARD

Sealed Refrigeration System contains refrigerant and oil under high pressure.

Proper safety procedures must be followed, and proper protective clothing must be worn when working with refrigerants.

Failure to follow these procedures could result in serious injury or death.

Undercharged Refrigerant Systems

An undercharged system will result in poor performance (low pressures, etc.) in both the heating and cooling cycle.

Whenever you service a unit with an undercharge of refrigerant, always suspect a leak. The leak must be repaired before charging the unit.

To check for an undercharged system, turn the unit on, allow the compressor to run long enough to establish working pressures in the system (15 to 20 minutes).

During the cooling cycle you can listen carefully at the exit of the metering device into the evaporator; an intermittent hissing and gurgling sound indicates a low refrigerant charge. Intermittent frosting and thawing of the evaporator is another indication of a low charge, however, frosting and thawing can also be caused by insufficient air over the evaporator.

Checks for an undercharged system can be made at the compressor. If the compressor seems quieter than normal, it is an indication of a low refrigerant charge.

A check of the amperage drawn by the compressor motor should show a lower reading. (Check the Unit Specification.) After the unit has run 10 to 15 minutes, check the gauge pressures. Gauges connected to system with an undercharge will have low head pressures and substantially low suction pressures.

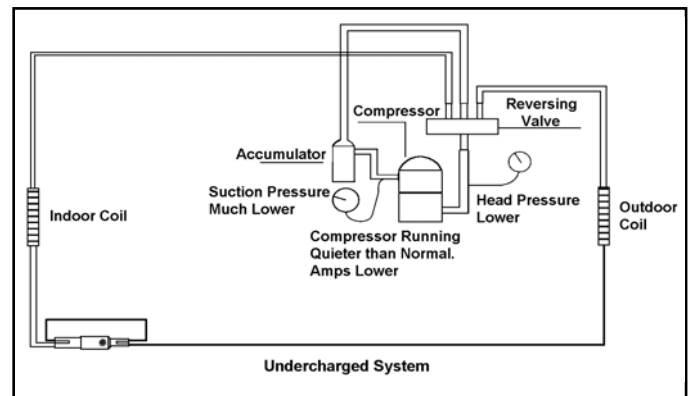

Overcharged Refrigerant Systems

Compressor amps will be near normal or higher. Noncondensables can also cause these symptoms. To confirm, remove some of the charge, if conditions improve, system may be overcharged. If conditions don't improve, Noncondensables are indicated.

Whenever an overcharged system is indicated, always make sure that the problem is not caused by air flow problems. Improper air flow over the evaporator coil may indicate some of the same symptoms as an over charged system.

An overcharge can cause the compressor to fail, since it would be "slugged" with liquid refrigerant.

The charge for any system is critical. When the compressor is noisy, suspect an overcharge, when you are sure that the air quantity over the evaporator coil is correct. Icing

of the evaporator will not be encountered because the refrigerant will boil later if at all. Gauges connected to system will usually have higher head pressure (depending upon amount of over charge). Suction pressure should be slightly higher.

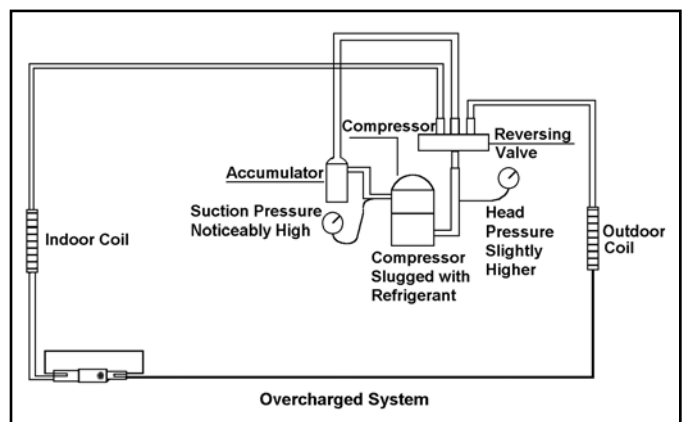

Restricted Refrigerant System

Troubleshooting a restricted refrigerant system can be difficult. The following procedures are the more common problems and solutions to these problems. There are two types of refrigerant restrictions: Partial restrictions and complete restrictions.

A partial restriction allows some of the refrigerant to circulate through the system.

With a complete restriction there is no circulation of refrigerant in the system.

Restricted refrigerant systems display the same symptoms as a "low-charge condition."

When the unit is shut off, the gauges may equalize very slowly.

Gauges connected to a completely restricted system will run in a deep vacuum. When the unit is shut off, the gauges will not equalize at all.

A quick check for either condition begins at the evaporator. With a partial restriction, there may be gurgling sounds

at the metering device entrance to the evaporator. The evaporator in a partial restriction could be partially frosted or have an ice ball close to the entrance of the metering device. Frost may continue on the suction line back to the compressor.

Often a partial restriction of any type can be found by feel, as there is a temperature difference from one side of the restriction to the other.

With a complete restriction, there will be no sound at the metering device entrance. An amperage check of the compressor with a partial restriction may show normal current when compared to the unit specification. With a complete restriction the current drawn may be considerably less than normal, as the compressor is running in a deep vacuum (no load.) Much of the area of the condenser will be relatively cool since most or all of the liquid refrigerant will be stored there.

The following conditions are based primarily on a system in the cooling mode.

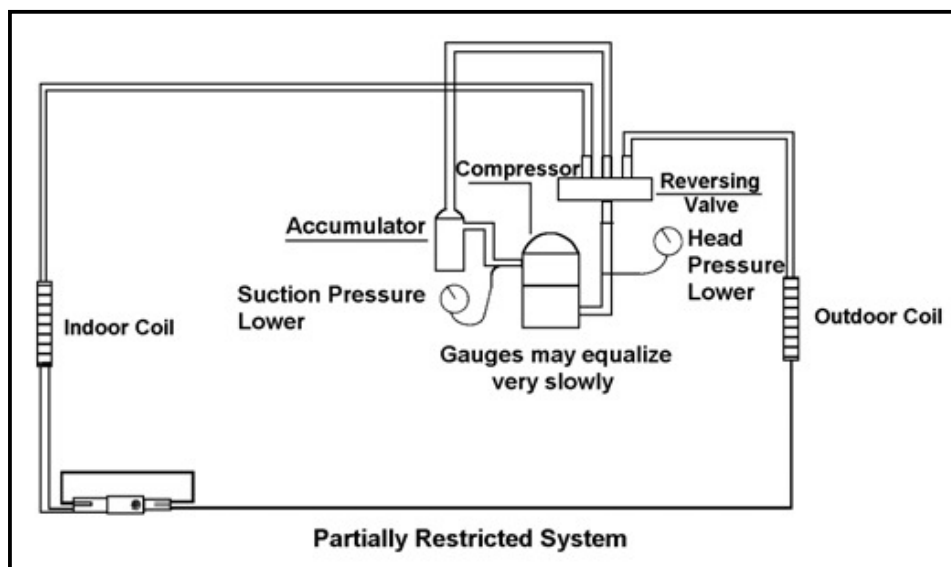
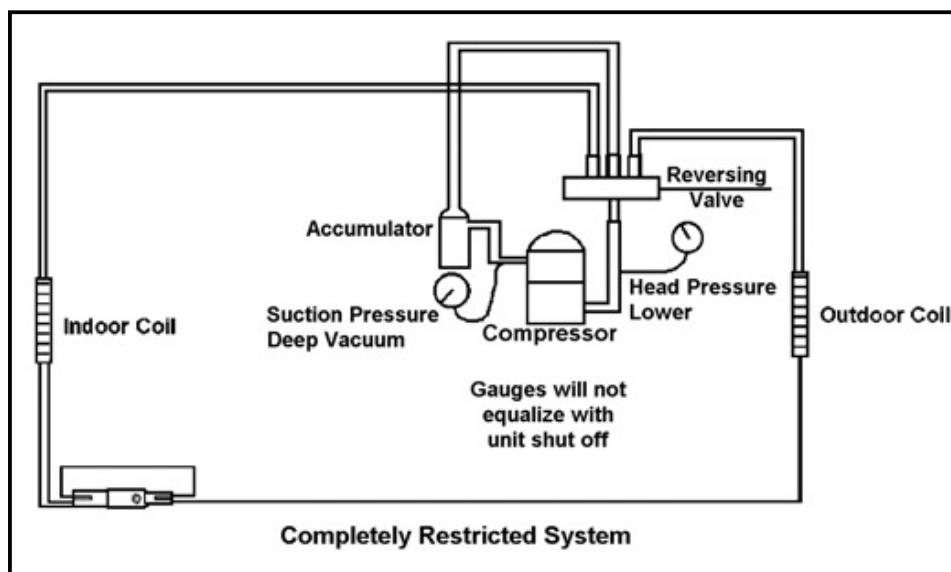

COMPRESSOR CHECKS

⚠ WARNING	
	<p>ELECTRIC SHOCK HAZARD Turn off electric power before service or installation. Extreme care must be used, if it becomes necessary to work on equipment with power applied.</p> <p>Failure to do so could result in serious injury or death.</p>

Locked Rotor Voltage (L.R.V.) Test

Locked rotor voltage (L.R.V.) is the actual voltage available at the compressor under a stalled condition.

Single Phase Connections

Disconnect power from unit. Using a voltmeter, attach one lead of the meter to the run "R" terminal on the compressor and the other lead to the common "C" terminal of the compressor. Restore power to unit.

Determine L.R.V.

Start the compressor with the volt meter attached; then stop the unit. Attempt to restart the compressor within a couple of seconds and immediately read the voltage on the meter. The compressor under these conditions will not start and will usually kick out on overload within a few seconds since the pressures in the system will not have had time to equalize. Voltage should be at or above minimum voltage of 197 VAC, as specified on the rating plate. If less than minimum, check for cause of inadequate power supply; i.e., incorrect wire size, loose electrical connections, etc.

Amperage (L.R.A.) Test

The running amperage of the compressor is the most important of these readings. A running amperage higher than that indicated in the performance data indicates that a problem exists mechanically or electrically.

Single Phase Running and L.R.A. Test

NOTE: Consult the specification and performance section for running amperage. The L.R.A. can also be found on the rating plate.

⚠ WARNING	
	<p>ELECTRIC SHOCK HAZARD Turn off electric power before service or installation. Extreme care must be used, if it becomes necessary to work on equipment with power applied.</p> <p>Failure to do so could result in serious injury or death.</p>

Select the proper amperage scale and clamp the meter probe around the wire to the "C" terminal of the compressor.

Turn on the unit and read the running amperage on the meter. If the compressor does not start, the reading will indicate the locked rotor amperage (L.R.A.).

⚠ WARNING	
	<p>ELECTRIC SHOCK HAZARD Disconnect power to the unit before servicing. Failure to follow this warning could result in serious injury or death.</p>

INTERNAL OVERLOAD

The compressors are equipped with an internal overload. The overload is embedded in the motor windings to sense the winding temperature and/or current draw. The overload is connected in series with the common motor terminal

Should the internal temperature and/or current draw become excessive, the contacts in the overload will open, turning off the compressor. The overload will automatically reset, but may require several hours before the heat is dissipated.

CHECKING THE INTERNAL OVERLOAD

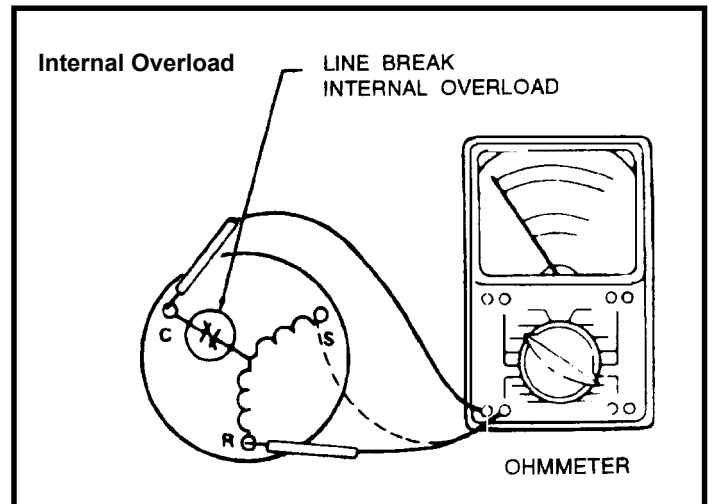

1. With no power to unit, remove the leads from the compressor terminals.
2. Using an ohmmeter, test continuity between terminals C-S and C-R. If no continuity, the compressor overload is open and the compressor must be replaced.

Single Phase Resistance Test

Remove the leads from the compressor terminals and set the ohmmeter on the lowest scale (R x 1).

Touch the leads of the ohmmeter from terminals common to start ("C" to "S"). Next, touch the leads of the ohmmeter from terminals common to run ("C" to "R").

Add values "C" to "S" and "C" to "R" together and check resistance from start to run terminals ("S" to "R"). Resistance "S" to "R" should equal the total of "C" to "S" and "C" to "R."

In a single phase PSC compressor motor, the highest value will be from the start to the run connections ("S" to "R"). The next highest resistance is from the start to the common connections ("S" to "C"). The lowest resistance is from the run to common. ("C" to "R") Before replacing a compressor, check to be sure it is defective.

Check the complete electrical system to the compressor and compressor internal electrical system, check to be certain that compressor is not out on internal overload.

Complete evaluation of the system must be made when ever you suspect the compressor is defective. If the compressor has been operating for sometime, a careful examination must be made to determine why the compressor failed.

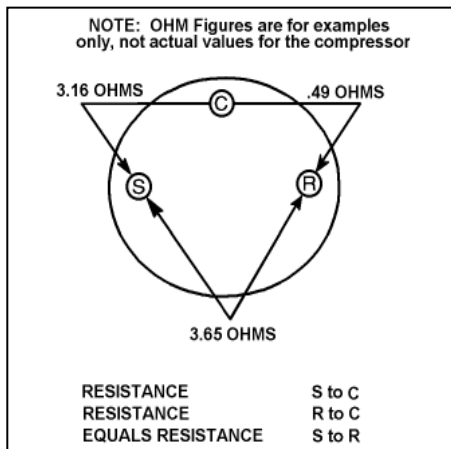

Many compressor failures are caused by the following conditions:

1. Improper air flow over the evaporator.
2. Overcharged refrigerant system causing liquid to be returned to the compressor.
3. Restricted refrigerant system.
4. Lack of lubrication.
5. Liquid refrigerant returning to compressor causing oil to be washed out of bearings.
6. Noncondensables such as air and moisture in the system. Moisture is extremely destructive to a refrigerant system.

COMPRESSOR REPLACEMENT

Recommended procedure for compressor replacement

⚠ WARNING	
	RISK OF ELECTRIC SHOCK Unplug and/or disconnect all electrical power to the unit before performing inspections, maintenances or service.
	Failure to do so could result in electric shock, serious injury or death.

1. Be certain to perform all necessary electrical and refrigeration tests to be sure the compressor is actually defective before replacing.

⚠ WARNING	
	HIGH PRESSURE HAZARD Sealed Refrigeration System contains refrigerant and oil under high pressure.
	Proper safety procedures must be followed, and proper protective clothing must be worn when working with refrigerants.
	Failure to follow these procedures could result in serious injury or death.

2. Recover all refrigerant from the system though the process tubes. **PROPER HANDLING OF RECOVERED REFRIGERANT ACCORDING TO EPA REGULATIONS IS REQUIRED.** Do not use gauge manifold for this purpose if there has been a burnout. You will contaminate your manifold and hoses. Use a Schrader valve adapter and copper tubing for burnout failures.

⚠ WARNING	
	HIGH TEMPERATURES Extreme care, proper judgment and all safety procedures must be followed when testing, troubleshooting, handling or working around unit while in operation with high temperature components. Wear protective safety aids such as: gloves, clothing etc.
	Failure to do so could result in serious burn injury.

NOTICE	
FIRE HAZARD	
The use of a torch requires extreme care and proper judgment. Follow all safety recommended precautions and protect surrounding areas with fire proof materials. Have a fire extinguisher readily available. Failure to follow this notice could result in moderate to serious property damage.	

3. After all refrigerant has been recovered, disconnect suction and discharge lines from the compressor and remove compressor. Be certain to have both suction and discharge process tubes open to atmosphere.
4. Carefully pour a small amount of oil from the suction stub of the defective compressor into a clean container.
5. Using an acid test kit (one shot or conventional kit), test the oil for acid content according to the instructions with the kit.
6. If any evidence of a burnout is found, no matter how slight, the system will need to be cleaned up following proper procedures.
7. Install the replacement compressor.

⚠ WARNING	
	<p>EXPLOSION HAZARD</p> <p>The use of nitrogen requires a pressure regulator. Follow all safety procedures and wear protective safety clothing etc.</p> <p>Failure to follow proper safety procedures result in serious injury or death.</p>

8. Pressurize with a combination of R-410A and nitrogen and leak test all connections with an electronic or Halide leak detector. Recover refrigerant and repair any leaks found.

Repeat Step 8 to insure no more leaks are present.

9. Evacuate the system with a good vacuum pump capable of a final vacuum of 200 microns or less. The system should be evacuated through both liquid line and suction line gauge ports. While the unit is being evacuated, seal all openings on the defective compressor. Compressor manufacturers will void warranties on units received not properly sealed. Do not distort the manufacturers tube connections.

⚠ CAUTION	
	<p>FREEZE HAZARD</p> <p>Proper safety procedures must be followed, and proper protective clothing must be worn when working with liquid refrigerant.</p> <p>Failure to follow these procedures could result in minor to moderate injury.</p>

10. Recharge the system with the correct amount of refrigerant. The proper refrigerant charge will be found on the unit rating plate. The use of an accurate measuring device, such as a charging cylinder, electronic scales or similar device is necessary.

SPECIAL PROCEDURE IN THE CASE OF MOTOR COMPRESSOR BURNOUT

⚠ WARNING	
	<p>ELECTRIC SHOCK HAZARD</p> <p>Turn off electric power before service or installation.</p> <p>Failure to do so may result in personal injury, or death.</p>

⚠ WARNING	
	<p>HIGH PRESSURE HAZARD</p> <p>Sealed Refrigeration System contains refrigerant and oil under high pressure.</p> <p>Proper safety procedures must be followed, and proper protective clothing must be worn when working with refrigerants.</p> <p>Failure to follow these procedures could result in serious injury or death.</p>

⚠ WARNING	
	<p>EXPLOSION HAZARD</p> <p>The use of nitrogen requires a pressure regulator. Follow all safety procedures and wear protective safety clothing etc.</p> <p>Failure to follow proper safety procedures result in serious injury or death.</p>

1. Recover all refrigerant and oil from the system.
2. Remove compressor, capillary tube and filter drier from the system.
3. Flush evaporator condenser and all connecting tubing with dry nitrogen or equivalent. Use approved flushing agent to remove all contamination from system. Inspect suction and discharge line for carbon deposits. Remove and clean if necessary. Ensure all acid is neutralized.
4. Reassemble the system, including new drier strainer and capillary tube.
5. Proceed with step 8-10 on previous section.

ROUTINE MAINTENANCE

⚠ WARNING



ELECTRIC SHOCK HAZARD

Turn off electric power before inspections, maintenances, or service.

Extreme care must be used, if it becomes necessary to work on equipment with power applied.

Failure to do so could result in serious injury or death.

⚠ WARNING



EXCESSIVE WEIGHT HAZARD

Use two people to lift or carry the unit, and wear proper protective clothing.

Failure to do so may result in personal injury.

⚠ WARNING



CUT/SEVER HAZARD

Be careful with the sharp edges and corners. Wear protective clothing and gloves, etc.

Failure to do so could result in serious injury.

NOTICE

Units are to be inspected and serviced by qualified service personnel only. Use proper protection on surrounding property. Failure to follow this notice could result in moderate or serious property damage.

NOTICE

Do not use a caustic coil cleaning agent on coils or base pan. Use a biodegradable cleaning agent and degreaser, to prevent damage to the coil and/or base pan.

AIR FILTER

Clean the unit air intake filter at least every 300 to 350 hours of operation. Clean the filters with a mild detergent in warm water and allow to dry thoroughly before reinstalling.

COILS AND BASE PAN

The indoor coil (evaporator coil), the outdoor coil (condenser coil) and base pan should be inspected periodically (yearly or bi-yearly) and cleaned of all debris (lint, dirt, leaves, paper, etc.). Clean the coils and base pan with a soft brush and compressed air or vacuum. If using a pressure washer, be careful not to bend the aluminium fin pack. Use a sweeping up and down motion in the direction of the vertical aluminum fin pack when pressure cleaning coils. Cover all electrical components to protect them from water or spray. Allow the unit to dry thoroughly before reinstalling it in the sleeve.

BLOWER WHEEL / HOUSING / CONDENSER FAN / SHROUD

Inspect the indoor blower housing, evaporator blade, condenser fan blade and condenser shroud periodically (yearly or bi-yearly) and clean of all debris (lint, dirt, mold, fungus, etc.). Clean the blower housing area and blower wheel with an antibacterial / antifungal cleaner. Use a biodegradable cleaning agent and degreaser on condenser fan and condenser shroud. Use warm or cold water when rinsing these items. Allow all items to dry thoroughly before reinstalling them.

ELECTRONIC / ELECTRICAL / MECHANICAL

Periodically (at least yearly or bi-yearly): inspect all control components: electronic, electrical and mechanical, as well as the power supply. Use proper testing instruments (voltmeter, ohmmeter, ammeter, wattmeter, etc.) to perform electrical tests. Use an air conditioning or refrigeration thermometer to check room, outdoor and coil operating temperatures. Use an electronic tester to measure wet bulb temperatures indoors and outdoors.

For performance tests use form on page 23.

ROUTINE MAINTENANCE (Continued)

NOTICE

Do not drill holes in the bottom of the drain pan or the underside of the unit. Not following this notice could result in damage to the unit or condensate water leaking inappropriately which could cause water damage to surrounding property.

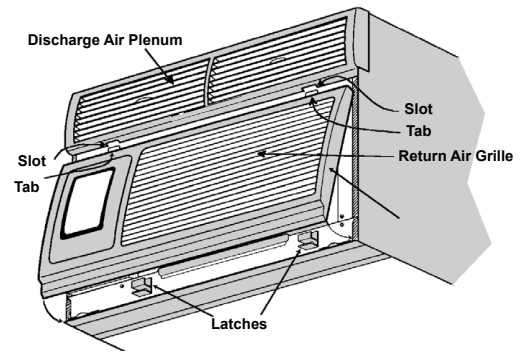

SLEEVE / DRAIN

Inspect the sleeve and drain system periodically (at least yearly or bi-yearly) and clean of all obstructions and debris. Clean both areas with an antibacterial and antifungal cleaner. Rinse both items thoroughly with water and ensure that the drain outlets are operating correctly. Check the sealant around the sleeve and reseal areas as needed.

FRONT COVER

Clean the front cover when needed. Use a mild detergent. Wash and rinse with warm water. Allow it to dry thoroughly before reinstalling it in the chassis.

CLEARANCES

Inspect the surrounding area (inside and outside) to ensure that the unit's clearances have not been compromised or altered.

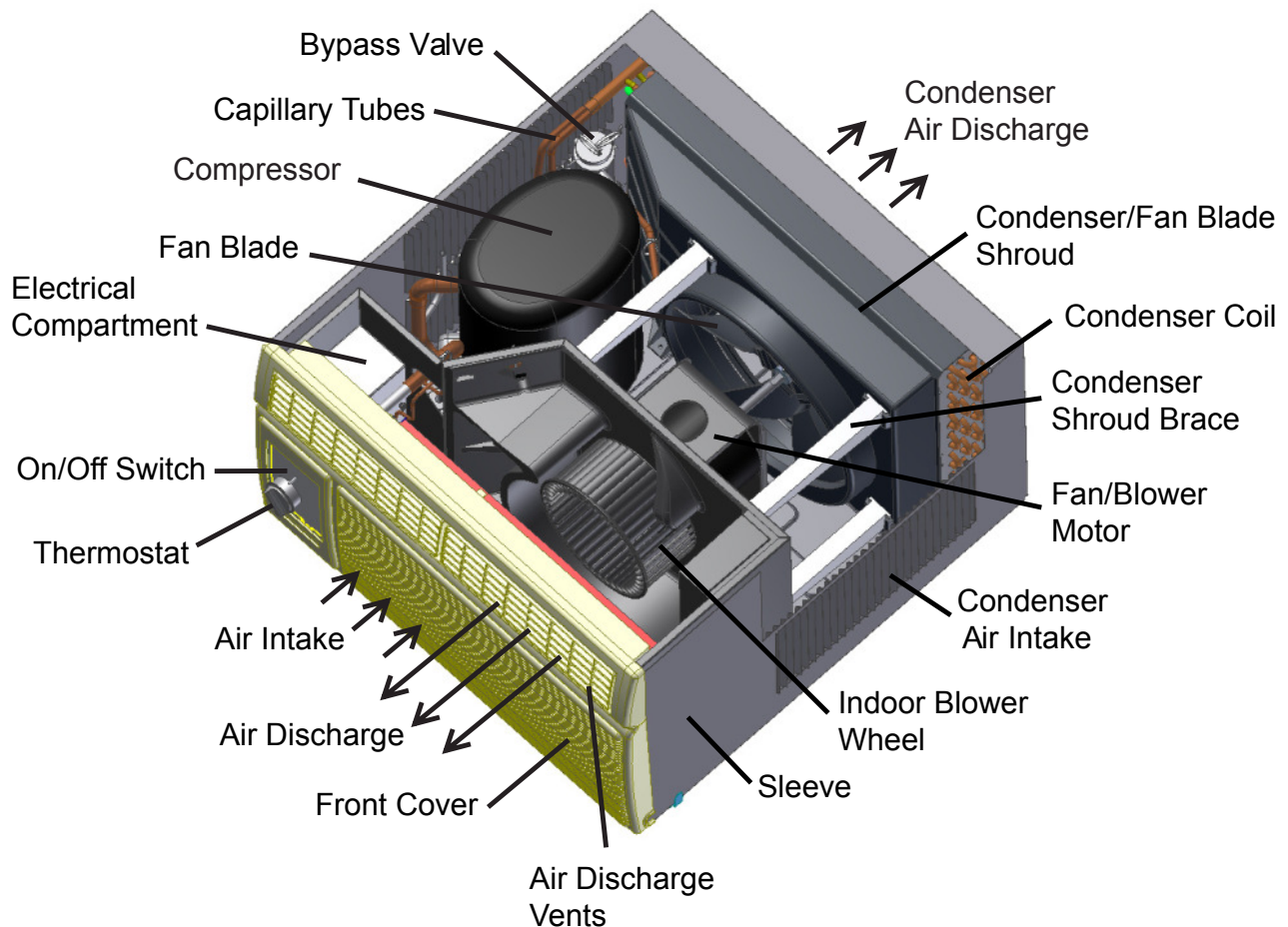

ROOM AIR CONDITIONER UNIT PERFORMANCE TEST DATA SHEET

DATE: _____ MODEL: _____ SERIAL: _____

	YES	NO
IS THERE A FRIEDRICH SLEEVE INSTALLED?	_____	_____
IS THERE A CHASSIS SEAL GASKET INSTALLED?	_____	_____
IS MAINTENANCE BEING PERFORMED?	_____	_____

If NO is checked use back of sheet for explanation

ELECTRICAL:

LINE VOLTAGE (STATIC) ----- VOLTS
 START UP VOLTAGE ----- VOLTS
 AMPERAGE DRAW ----- AMPS (COOL)
 AMPERAGE DRAW ----- AMPS (HEAT)

COMPRESSOR

LOCKED ROTOR AMPS ----- AMPS
 RUNNING AMPERAGE DRAW ----- AMPS

INDOOR TEMPERATURES:

INDOOR AMBIENT TEMPERATURE ----- F
 RELATIVE HUMIDITY (RH) INDOOR ----- %

	COOL	HEAT
DISCHARGE AIR TEMPERATURE (INDOOR)	----- F	----- F
RETURN AIR TEMPERATURE (INDOOR)	----- F	----- F
DIFFERENTIAL	----- F	----- F

OUTDOOR TEMPERATURE:

OUTDOOR AMBIENT TEMPERATURE ----- F
 RELATIVE HUMIDITY (RH) ----- %

CONDENSER:

DISCHARGE AIR TEMPERATURE (OUTDOOR) ----- F ----- F
 INTAKE AIR TEMPERATURE (OUTDOOR) ----- F ----- F
 DIFFERENTIAL ----- F ----- F

APPLICATION USE ----- ROOM (RESIDENTIAL OR COMMERCIAL)

COOLING OR HEATING AREA W ----- X L ----- X H ----- = SQ/FT -----

Sizing your air conditioner correctly is vital.

Sizing Guide

The following guide is based on normal room insulation average number of sun-exposed windows and two-person occupancy.

FT ²	Btu/h
100-150	5,000
150-250	6,000
250-300	7,000
300-350	8,000
350-400	9,000
400-450	10,000
450-550	12,000
550-700	14,000
700-1,000	18,000
1,000-1,200	21,000
1,200-1,400	23,000
1,400-1,600	25,000
1,600-1,900	28,000
1,900-2,700	36,000

This is a general guide.
 Please consult manual J or M for exact load calculations.

1. If heavily shaded, reduce capacity 10%.
2. If very sunny, add 10%.
3. Add 500 BTU/H per person over 2 people.
4. Add 4,000 BTU/H if area is a kitchen.

Due to variations in room design, climate zone and occupancy, larger areas may require the use of multiple units to provide the optimal cooling solution.

TROUBLESHOOTING

Problem	Possible Cause	Possible Solution
Unit does not run	Power disconnected.	Check power source.
	Branch circuit fuse blown or circuit breaker tripped.	Replace fuse, reset breaker. If repeats, check fuse or breaker size. Check for shorts in unit wiring and components.
	Loose or disconnected wiring at switch.	Check wiring & connections. Connect per wiring diagram.
	Inoperative switch (On-Off).	Test for continuity, 3 and 2, 5 and 6. If bad, replace.

Problem	Possible Cause	Possible Solution
Evaporator coil freezes up	Dirty filter.	Clean as recommended in Owner's Manual.
	Restricted airflow.	Check for dirty or obstructed coil clean as required.
	Inoperative thermostat.	Test for shorted thermostat or stuck contacts.
	Short of refrigerant.	De-ice coil and check for leak.
	Partially restricted capillary.	De-ice coil. Check temperature differential across coil. Touch-test coil return bends for same temperature. Test for low running current.
	Inoperative fan motor.	Test fan motor & replace if inoperative.

Problem	Possible Cause	Possible Solution
Compressor runs continually. Does not cycle off.	Excessive heat load.	Test cooling performance of unit. Unit undersized.
	Restriction in line.	Check for partially iced coil. Check temperature split across coil.
	Refrigerant leak.	Check for presence of oil on silver soldered connections. Check for partially iced coil. Check split across coil. Check for low running amperage.
	Thermostat contacts stuck.	Check operation of thermostat. Replace if contacts remain closed.
	Incorrect thermostat setting.	Set to correct setting.

Problem	Possible Cause	Possible Solution
Thermostat does not turn on compressor	Loss of charge in thermostat bulb.	Replace thermostat.
	Thermostat contacts open.	Test for continuity at terminals 1 and 2. Replace if defective.
	Incorrect wiring or loose wires.	Connect per wiring diagram. Tighten loose wires.
	System switch open.	Test for continuity at switch terminals 2 and 3.

Problem	Possible Cause	Possible Solution
Thermostat does not turn off compressor	Thermostat set at coldest point	Adjust.
	Thermostat contacts stuck.	Disconnect power to the unit. Remove cover of thermostat and check if contact is stuck, if so replace thermostat.
	Switch (On-Off) shorted.	Test switch for open contacts at terminals 2 and 3 with switch in "Off" position.

TROUBLESHOOTING

Problem	Possible Cause	Possible Solution
Compressor attempts to start, or runs for short periods only. Cycles on overload.	Compressor attempts to start before system pressures are equalized.	Allow a minimum of 3 minutes to allow pressures to equalize before attempting to start.
	Low or fluctuating voltage.	Check voltage with unit operating. Check for other appliances on the circuit. Unit should be on separate circuit for proper voltage, and be fused separately
	Incorrect wiring	Connect per appropriate wiring diagram
	Shorted or incorrect capacitor	Replace capacitor
	Restricted or low air flow through condenser coil	Check motor fan blade.
	Compressor running abnormally hot	Check for refrigerant restriction, blocked airflow, loose wires at compressor terminals and fan motor capacitor voltage.
	Overload opens too soon.	Change compressor if all other corrections above are normal.

Problem	Possible Cause	Possible Solution
Compressor does not start - fan motor runs.	Thermostat contacts not closing.	Check continuity of thermostat at coldest setting. If compressor runs, replace thermostat.
	Low voltage supply.	Check for nameplate voltage. Provide proper voltage.
	Switch (On-Off) inoperative.	Test for continuity.
	Defective capacitor.	Test with analyzer, replace if needed.
	Compressor internal overload open.	Check voltage at compressor terminals. If voltage is satisfactory, replace compressor.
	Solid state relay open.	Replace relay.
	Open or shorted compressor windings.	Check windings for continuity and resistance. If open, replace compressor.

Problem	Possible Cause	Possible Solution
Does not cool, or cools only slightly.	Thermostat open or inoperative.	Set to coldest position. Test thermostat and replace if necessary.
	Dirty air filter.	Clean as recommended in Owner's Manual.
	Dirty or plugged condenser or evaporator coil.	Clean coils.
	Poor air circulation in area being cooled.	Adjust air louvers. Check application. Check for dirty filter or evap coil. Check fan motor. Correct as needed.
	Low capacity - undercharge.	Check for leak and make necessary repairs.
	Compressor not pumping properly.	Replace compressor.

NOTE: If Inside Coil Freezes Up

Your Friedrich Hazardgard is designed not to freeze with outdoor temperatures as low as 45°F (7°C). If the indoor coil should ice over while cooling, set the thermostat to the warmest position until the ice on the coil is gone. Setting the thermostat to a slightly warmer position will probably keep ice from forming on the coil. A dirty filter will contribute to icing.

TROUBLESHOOTING

Problem	Possible Cause	Possible Solution
Fan motor does not run.	Defective switch (On-Off)	Check continuity across terminals 2 and 3.
	Fan capacitor open.	Test with capacitor analyzer. Replace if bad.
	Inoperative fan motor.	Check power and if okay, perform continuity test. Replace if bad.
	Incorrect wiring of fan circuit.	Connect per wiring diagram.
	Solid state relay open.	Replace relay.
	Seized motor bearings.	Replace motor.
	Bound fan blade or blower wheel.	Adjust for proper clearance.

Problem	Possible Cause	Possible Solution
Switch (On-Off) does not cut fan motor off.	Defective (On-Off) switch or defective relay.	Replace switch or relay.

Problem	Possible Cause	Possible Solution
Noisy and/or vibration.	Poor installation.	Refer to installation instructions for proper installation.
	Fan blade striking chassis or blower wheel housing.	Adjust fan blade or blower wheel clearance.
	Compressor vibrating.	Check for deteriorated compressor grommets. Replace as needed.
	Loose cabinet parts, improperly mounted components, tubing rubbing.	Adjust and tighten as required.

Problem	Possible Cause	Possible Solution
Water leaks into room.	Evaporator drain pan overflowing.	Clean obstructed drain trough.
	Condensation forming on bottom of base pan.	Evaporator drain pan broken or cracked. Replace chassis seal gasket missing or defective.
	Water dripping from discharge air grilles.	Dirty evaporator coil, or extremely high humidity conditions. Clean coil or check application.

Problem	Possible Cause	Possible Solution
Excessive water leaks outside.	Extremely high humid conditions.	Install 01900-235 drain kit.
	Water in center section of base pan (compressor area).	Drain trough. Check level. Ensure 1/4" tilt toward rear.
	Dirty condenser coil.	Clean with steam or detergent.
	Fan blade and slinger ring improperly positioned.	Adjust fan blade to 1/2" clearance from condenser coil.

ELECTROMECHANICAL CONTROL COOL ONLY MODELS: SH15M30 * SH20M30 *

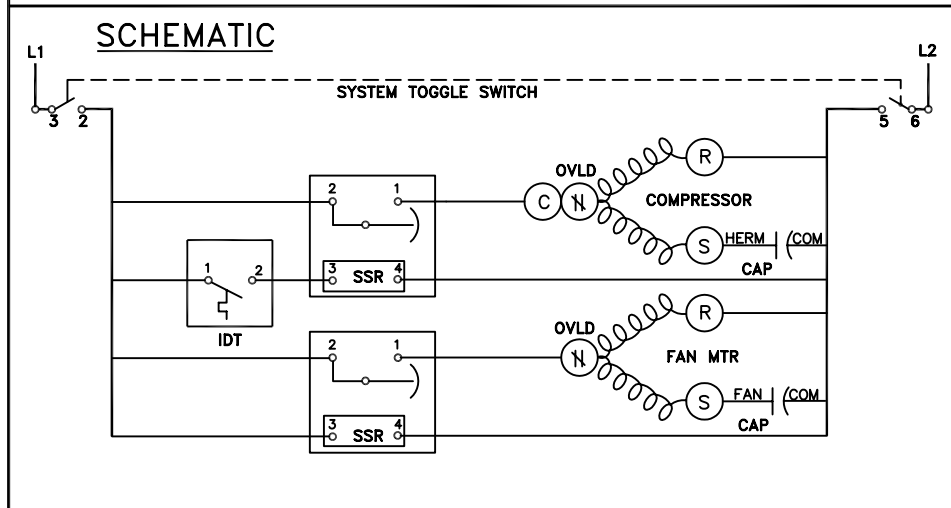
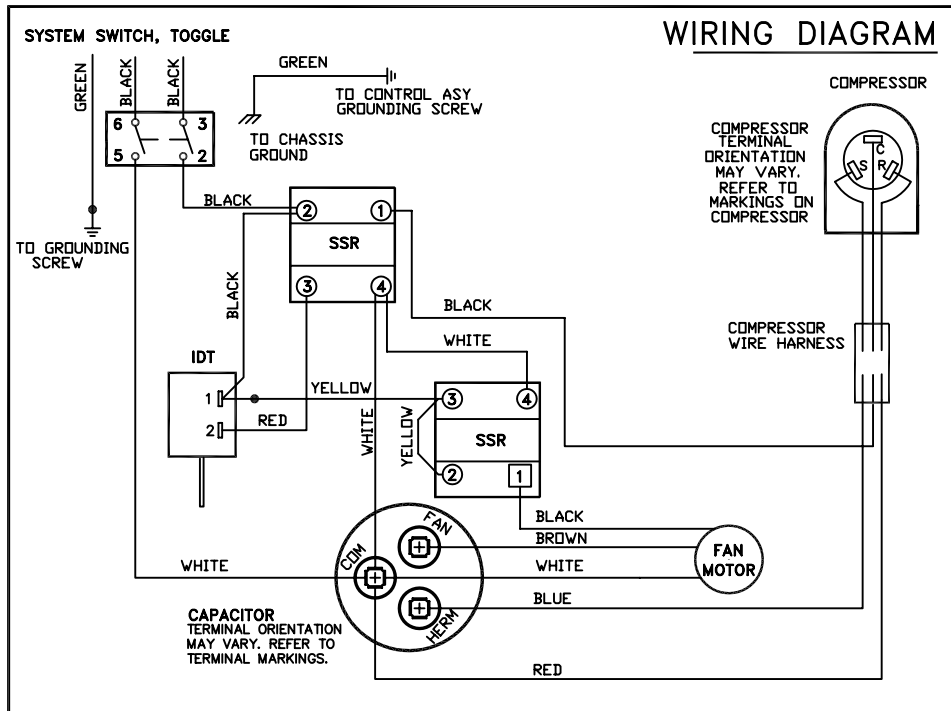

LEGEND

SSR	- SOLID STATE RELAY		- GROUND LEAD
CAP	- CAPACITOR		- COMBINATION TERMINAL
COMPR	- COMPRESSOR		
MTR	- FAN MOTOR		
OVLD	- OVERLOAD PROTECTOR		
IDT	- INDOOR THERMOSTAT		

PART NO.	REV.
921-002-00	00

*Last character may vary.



Friedrich Air Conditioning Company
10001 Reunion Place, Suite 500
San Antonio, TX 78216
1-800-541-6645
www.friedrich.com

HAZARDGARD® ROOM AIR CONDITIONERS LIMITED WARRANTY

LIMITED ONE YEAR PARTS WARRANTY

1. Limited warranty – One year. Friedrich warrants that it will provide a replacement for any part of this Hazardgard Room Air Conditioner found defective in material or workmanship for a period of one (1) year from the date of original purchase.

2. Limited warranty – One year. The Friedrich warranty also covers the cost of labor for repairing any compressor, condenser, evaporator or inter-connecting tubing found defective within the warranty period, providing the unit is returned to an authorized Friedrich Repair Station located within the Continental United States.

The Friedrich warranty does not cover:

(1) Any charges for removal, transportation or reinstallation of the unit; (2) the cost of labor to replace parts other than those described above; and (3) does not apply to any HazardGard Room Air Conditioner that has been subject to (a) accident, misuse, flood, fire, or neglect; (b) repairs or alterations outside of the Friedrich Authorized Dealer or Service Center so as to affect adversely its performance and reliability; or (c) any repairs or servicing as a result of using parts not sold or approved by Friedrich.

LIMITATIONS: This warranty is a LIMITED warranty. Anything in the warranty notwithstanding, IMPLIED WARRANTIES FOR PARTICULAR PURPOSE AND MERCHANTABILITY SHALL BE LIMITED TO THE DURATION OF THE EXPRESS WARRANTY. MANUFACTURER EXPRESSLY DISCLAIMS AND EXCLUDES ANY LIABILITY FOR CONSEQUENTIAL OR INCIDENTAL DAMAGES FOR BREACH OF ANY EXPRESSED OR IMPLIED WARRANTY.

Performance of Friedrich's Warranty obligation is limited to one of the following methods:

1. Repair of the unit
2. A refund to the customer for the prorated value of the unit based upon the remaining warranty period of the unit.
3. Providing a replacement unit of equal value

The method of fulfillment of the warranty obligation is at the sole discretion of Friedrich Air Conditioning.

WARNING: - EXPLOSION HAZARD -

USE FRIEDRICH PARTS ONLY
SUBSTITUTION OF COMPONENTS MAY IMPAIR SUITABILITY FOR CLASS 1, DIVISION 2

TECHNICAL SUPPORT CONTACT INFORMATION



F R I E D R I C H

FRIEDRICH AIR CONDITIONING CO.

10001 Reunion Place, Ste. 500, San Antonio, TX 78216

(210) 546-0500 877-599-5665 x 261 FAX (210) 546-0731

Email: tac@friedrich.com

www.friedrich.com

Printed in the U.S.A.



F R I E D R I C H

FRIEDRICH AIR CONDITIONING CO.

10001 Reunion Place, Ste. 500, San Antonio, TX 78216

P 210-546-0500 | **F** 210-546-0731

www.friedrich.com

Printed in the U.S.A.

HG-ServMan (1-11)