

Age Range: 1-1/2 to 6 Years
 Weight Limit: 50 Lbs.
 Surfaces: Hard
 Speed: 2.5 MPH
 Colors: Black Body
 Blue Seat & Trim
 Intro: 1992
 Suggested Retail: \$149.99 - 169.99
 Warranty: 90 Days Vehicle
 6 Months Battery

76112-9993 / 84510 Super Flash®

6 Volt

Service Bulletin 138

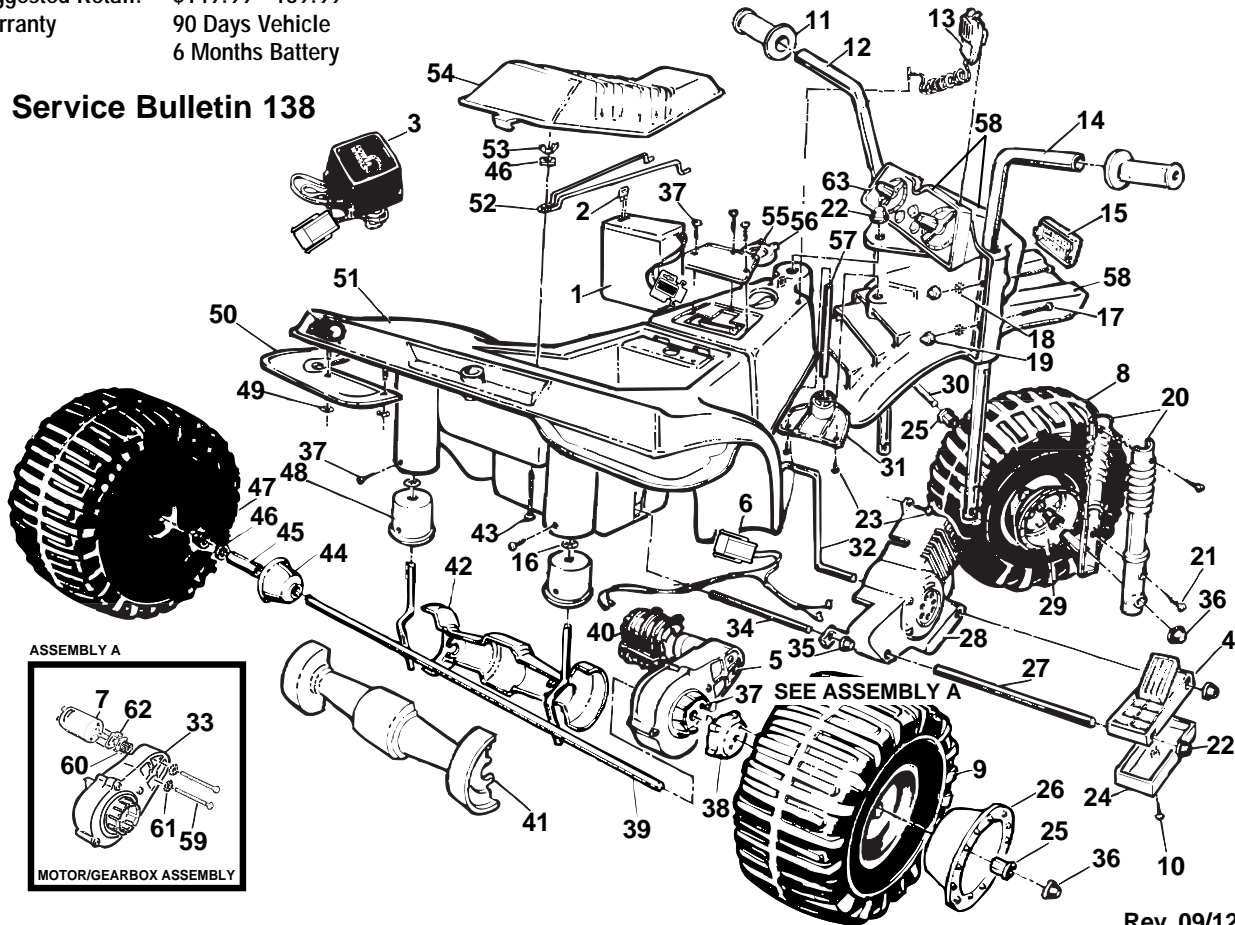

Rev. 09/12/03

Item No.	Description	Part No.	Qty.	Item No.	Description	Part No.	Qty.	Item No.	Description	Part No.	Qty.
1	**Battery 6-Volt (Type H)	00801-1234	1	26	Rear Hubcap	74590-2579	2	49	Retainer w/o Body N/A	78480-2249	8
2	25 amp Fuse Kit	0801-0151	1	27	Support Rod (Rear Foot Rest) (N/A)	80023-0091	1	50	Mud Flap Set N/A	74590-2219	1
3	**6-Volt Charger	00801-0975	1	28	Right False Motor	N/A	1	51	Body (N/A)	80005-0095	1
4	Footboard Assy.	76108-9159	1	29	Front Hubcap	73233-2579	2	52	Battery Retainer N/A	76112-4419	1
5	3A Motor/Gearbx Assy N/A	74510-9519	1	30	Front Axle (N/A)	80025-0006	1	53	Wing Nut	0801-0317	1
6	**Wiring Harness N/A	76112-9799	1	31	Flex Plate (N/A)	80001-0478	1	54	Seat (N/A)	80067-0063	1
7	Motor 6-Volt N/A	74510-0640	1	32	False Motor Support (N/A)	80021-0074	1	55	Switch Plate (N/A)	80001-0472	1
8	Front Wheel N/A	76266-2459	1	33	3A Gearbox N/A	74510-9519	1	56	Gas Cap (N/A)	80001-0471	1
9	Rear Wheel N/A	76188-2459	2	34	Support Rod (Rear Motor) (N/A)	80021-0036	1	57	Pivot Pin N/A	76108-4429	1
10	8 x 2" Screw N/A	0801-0268	1	35	Retainer .250 N/A	0801-0322	2	58	Fender/Instr. Case Assy (N/A)	80001-0220	1
11	Handgrip N/A	80028-0030	2	36	.437 Cap Nut	0801-0226	4	59	Motor Bolts	0801-0269	2
12	Left Handlebar (N/A)	80029-0087	1	37	#10 x 1/2" Screw	0801-0255	6	60	Motor Drive Gear (N/A)	80026-0105	1
13	Microphone/Cord Assy.	73233-9479	1	38	Driver	73233-2239	1	61	Star Washers	0801-0330	2
14	Right Handlebar (N/A)	80029-0088	1	39	Rear Axle Assembly (Include. #48) (N/A)	80046-0059	1	62	D Lock Washer	0801-0329	1
15	Headlight Lens	76112-2129	1	40	Motor Cover	74750-2579	1	63	Instrument Case Cover	(N/A)	1
16	Retainer 354 w/o Body N/A	0801-0252	2	41	Axle Cover (Outside) (N/A)	80046-0138	1	PARTS NOT SHOWN			
17	1-1/4" 10-32 Screw N/A	76125-4459	4	42	Axle Cover (Inside) N/A	80046-0133	1		Left False Motor	N/A	1
18	Star Washer N/A	76108-4419	4	43	Carriage Bolt N/A	0801-0305	1		Left Footrest	76108-2179	1
19	Acorn Nut N/A	0801-0218	4	44	Hubcap w/o Shoulder N/A	76108-2369	1		Decal Sheet (N/A)	80017-0232	1
20	Shock Set N/A	80001-0499	2	45	Spacer N/A	76112-2139	1		Literature Bag N/A	80044-0393	1
21	Plascrew 3/4"	0801-0223	4	46	Washer	0801-0196	2		Use & Care Manual N/A	76112-CCCC	1
22	.354 Cap Nut	0801-0604	6	47	Wheel Bushing	74550-2689	1				
23	Plascrew 1/2"	0801-0202	5	48	Axle Bushing (N/A)	80009-0085	2				
24	Bott Cover (Footboard) N/A	76108-2169	1								
25	Hex Bushing	73233-2559	4								

**See Service Bulletin 138 N/A = Not Available

Bold and Underlined parts are to be purchased and installed by Service Centers only. These items may not be sold directly to consumers by Service Centers or Fisher-Price.

