

This Owner's Manual is provided and hosted by [Appliance Factory Parts](#).



VIKING DRK36 Owner's Manual

[Shop genuine replacement parts for VIKING DRK36](#)



[Find Your VIKING Range Hoods Parts - Select From 411 Models](#)

----- Manual continues below -----

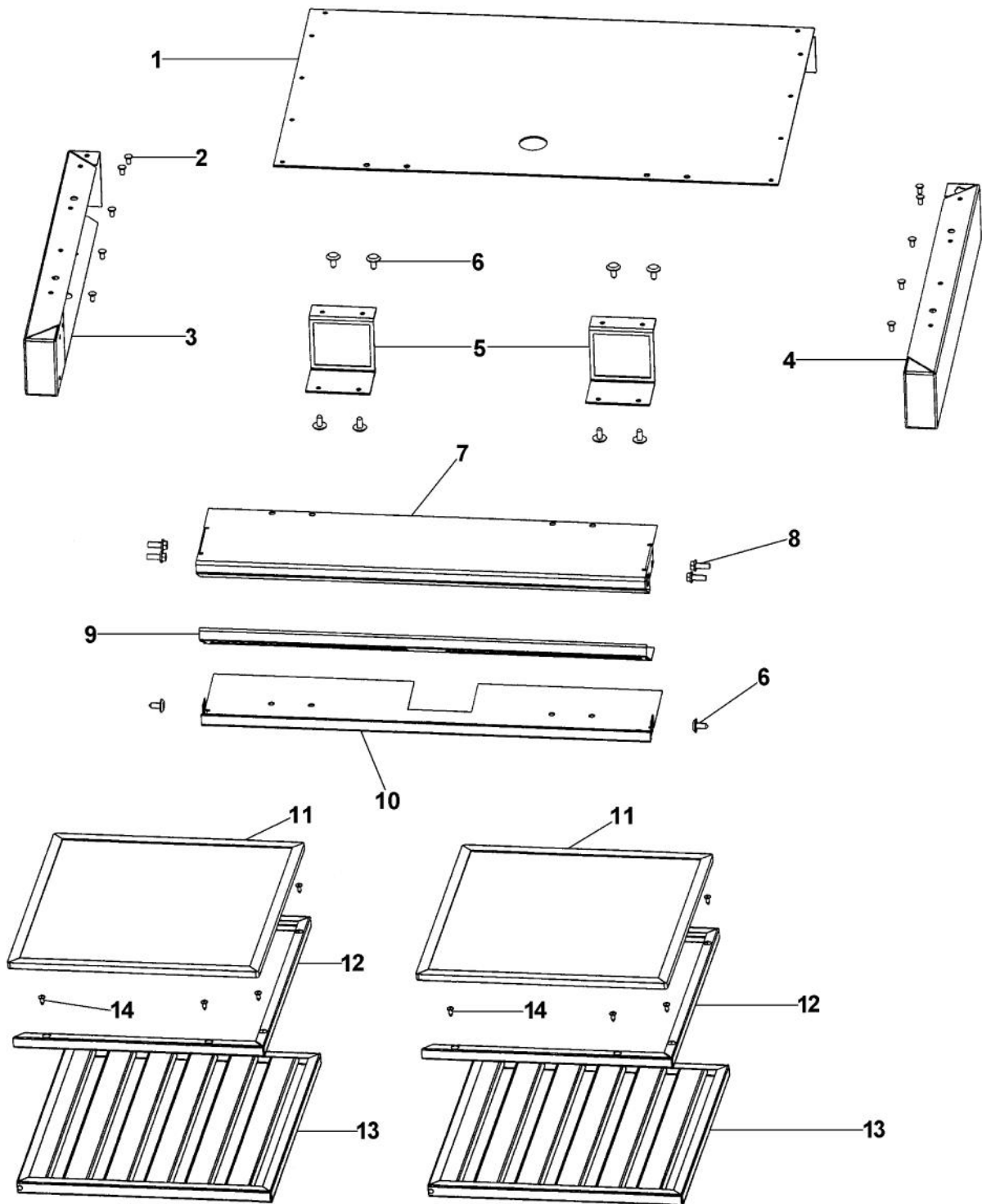

Ref #	Part Number	Qty.	Description
1	A20010238		TOP/REAR (DRK30/36)
2	PC040010		POP RIVET
3	B20010255		LH SIDE (DRK30/36)
4	B20010254		RH SIDE (DRK30/36)
5	A2008742		DRK MIDDLE SUPPORT BRACKET
6	PD020032		SRW-8(A)X3/8PH.WFR HD 7/16DIAXNICL
7	B20010237		TOP LOUVER (DRK30/36)
8	M0220417		SCREW-TC
9	B20010236		MIDDLE LOUVER (DRK30/36)
10	B20010235		BOTTOM LOUVER (DRK30/36)
11	CFD14		REPLACEMENT CHARCOAL FILTERS (DRK36)
12	B20010241		CHARCOAL FILTER CHANNEL (DRK36)
13	N/A		HEAT SHIELD - MUST ORDER ITEM NO. 11 (PART OF HOOD AND NOT DRK)
14	PD020010		10 X 3/8 GREEN GROUNDING SCREW



Ref #	Part Number	Qty.	Description
-------	-------------	------	-------------
