

This Owner's Manual is provided and hosted by [Appliance Factory Parts](http://www.appliancefactoryparts.com).



VIKING VGSO166 Owner's Manual

[Shop genuine replacement parts for VIKING VGSO166](#)



[Find Your VIKING Oven Parts - Select From 98 Models](#)

----- Manual continues below -----

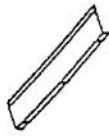

① BURNER DIVIDER

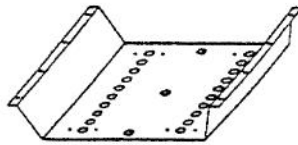

② AIR PLATE



③ OVEN BOTTOM PAN SUPT.



④ REAR BURNER SUPT. BRACKET



⑤ BAKE ORIFICE MTG. BRACKET



⑥ OVEN BURNER



⑦ IGNITOR



⑧ PAN NUT



⑨ OVEN BURNER HOLDER

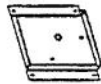

⑩ FAN BOX

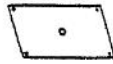

⑪ FAN BOX COVER



⑫ CONVECTION FAN MOTOR



⑬ HINGE ASSEMBLY



⑭ OVEN LIGHT ASSEMBLY

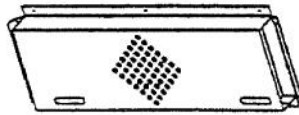

⑮ CONVECTION FAN COVER ASSEMBLY

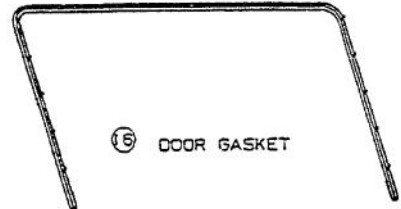

⑯ DOOR GASKET

Ref #	Part Number	Qty.	Description
1	A2002255		BURNER DIVIDER (VGSO166)
2	A2002656		BLANK AIR PLATE
3	A2000606		OVEN BTM PAN SUPT
4	A2001368		REAR BURNER SUPT BRKT LH
5	A2002257		BAKE ORIFICE MOUNTING BRKT LH
6	PB050014		OVEN BURNER LH-
7	PB040001		IGNITOR - (ALL RANGES)
8	PD030018		PALNUT - 3/4-16
9	A2001365		OVEN BURNER HOLDER LH (VGSC)
10	A2002595		CONVECTION FAN BOX (VDSC)
11	A1002596		CONVECTION FAN COVER (VDSC)
12	PE050057		CONVECTION FAN (VGSC306)
13	PC020003		HINGE ASSY (BLUE)
14	PE050009		OVEN LIGHT SOCKET - 36 BUILT-IN
15	E9107600		CONVECTION FAN COVER
16	PB070015		DOOR GASKET - VGSO165
NI	A2008467		INSULATION SHIELD

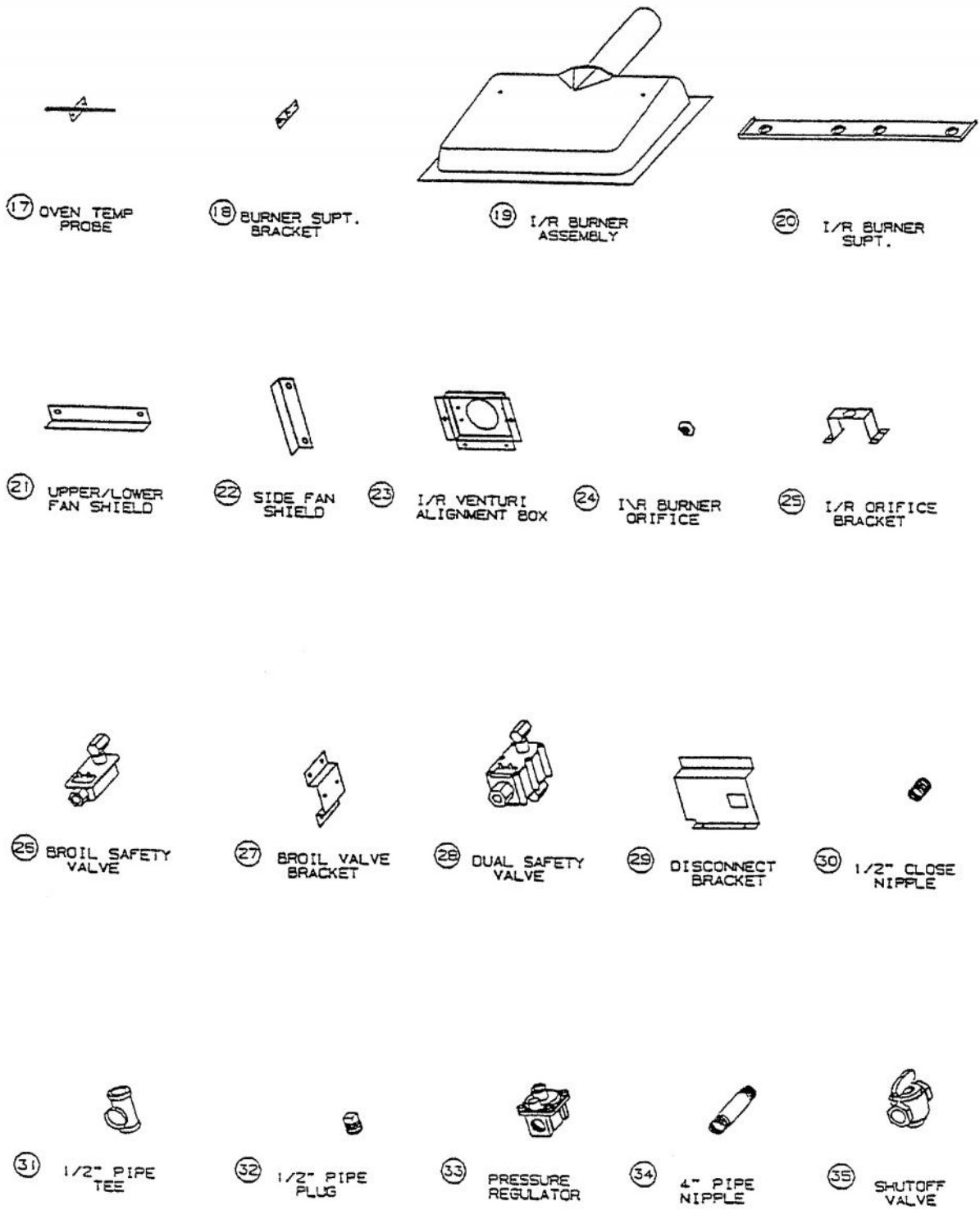

Ref #	Part Number	Qty.	Description
17	PB010116		OVEN TEMPERATURE PROBE
18	A2001450		IGNITER BURNER SUPT BRKT
19	G3002211		IR BURNER ASSY (VGSO166)
20	B2002261		I/R BURNER SUPPORT - REAR
20	B2001448		IR BROIL SUPT (FRONT)
21	A2001745		UPPER / LOWER FAN SHIELD
22	A2001746		SIDE FAN SHIELD
23	A2002216		IR VENTURI ALIGNMENT BOX (VGSO166)
24	PB040026		IR BURNER ORIFICE - NO.48 NAT.
25	A2002217		IR ORIFICE BRKT (VGSO166)
26	PB010083		SINGLE THERMAL VALVE LH (OVEN)
27	A2002239		BROIL VALVE BRKT (VGSO166)
28	PB010084		DUAL THERMAL BI-MTL GAS CTRL VALVE
29	A2002220		DISCONNECT BRKT (VGSO166)
30	PB040046		1/2 CLOSE NIPPLE (VGSO166)
31	PA050031		PIPE TEE - 1/2 FEMALE
32	PA050032		PIPE PLUG - 1/2
33	PA070001		PRESSURE REGULATOR (NAT.)
34	PA050033		PIPE NIPPLE - 1/2 X 3
35	PB030006		SHUT-OFF VALVE (VGSO166)

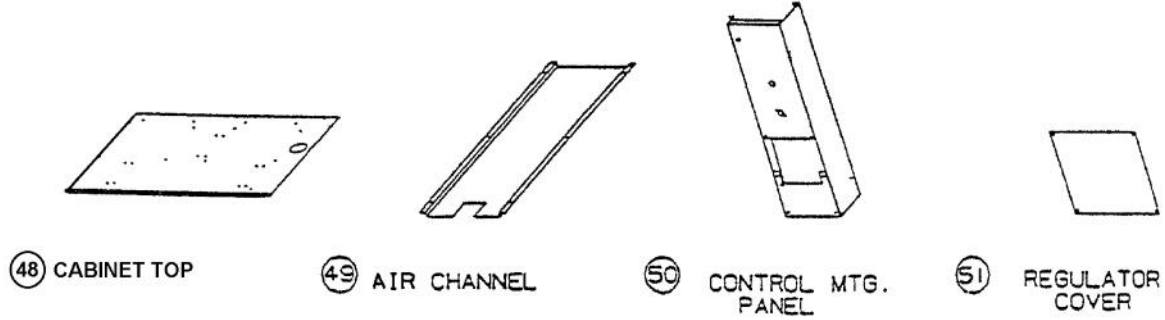
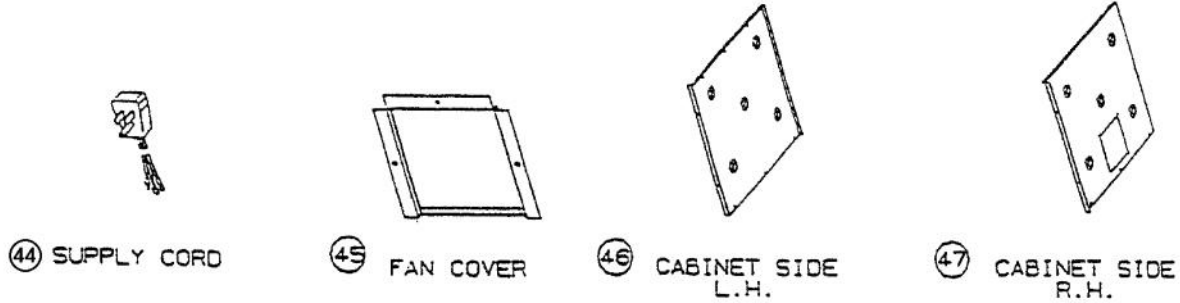
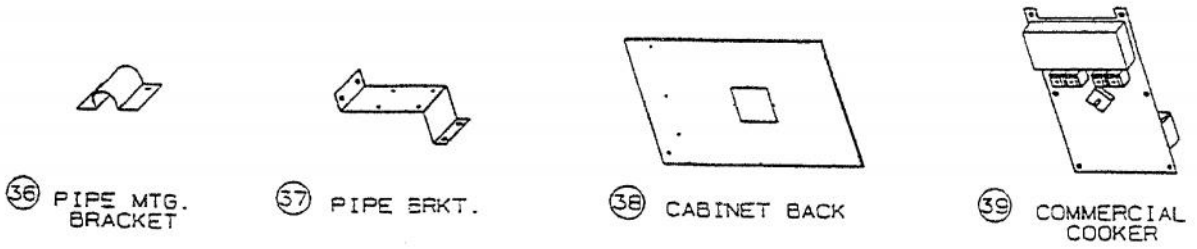

Ref #	Part Number	Qty.	Description
36	A2002265		MOUNTING BRKT PIPE (VGSO166)
37	A2002264		PIPE BRKT (VGSO166)
38	A2002221		CABINET BACK (VGSO166)
39	PE050061		WORLDTRONIC CLOCK/TIMER
NI	G5004598BK		VGSO166 BK CTRL PANEL ASSY
NI	G5004599WH		VGSO166 WH CTRL PANEL ASSY
40	PB040045		3/8 UNION TEE (VGSO166)
41	PB040044		90-DEG. MALE ELBOW
42	A2002224		TOP TRIM BRKT (VGSO166)
43	PD040005		SNAP BUSHING - 7/8
44	PE070128		SUPPLY CORD (VGRT/SC/SS/RC)
45	A2002263		FAN MOTOR COVER (VGSO166)
46	A2002222		CABINET SIDE LH (VGSO166)
47	A2002240		CABINET SIDE RH (VGSO166)
48	A2002223		CABINET TOP (VGSO166)
49	A2002258		AIR CHANNEL (VGSO166)
50	A2002236		CONTROL MOUNTING PANEL (VGSO166)
51	A1002252		REGULATOR COVER (VGSO166)

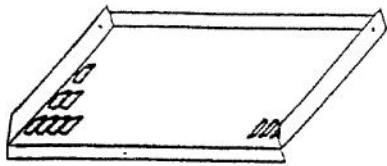

52 OVEN BOTTOM ASSEMBLY

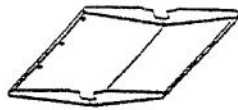

53 OVEN BOTTOM HEAT SHIELD

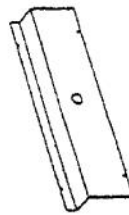

54 CONTROL COVER

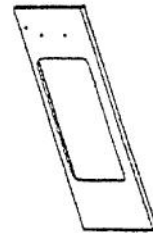

55 CONTROL PANEL TRIM - WELD

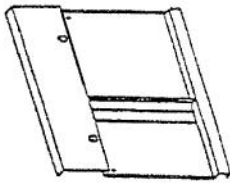

56 INSIDE OVEN LINER R.H.

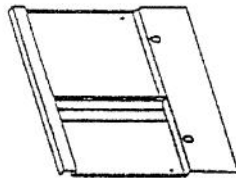

57 INSIDE OVEN LINER L.H.

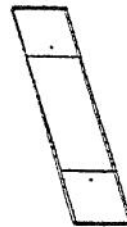

58 CONTROL PANEL GLASS CLIP

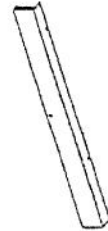

59 SIDE TRIM



60 SELECTOR SWITCH



61 LIGHT SWITCH



62 PC BOARD STANDOFF



63 TRIM CORNER BRACKET



64 BOTTOM TRIM BRACKET



65 BROILER PAN TRAY

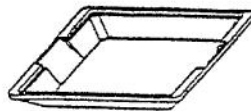

66 BROILER PAN

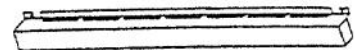

67 KICKPLATE

Ref #	Part Number	Qty.	Description
52	G9102273		SUB TO G3204251 - OVEN BTM PAN
53	A2002269		OVEN BTM HEAT SHIELD (VGSO166)
54	A2002262		CONTROL COVER (VGSO166)
55	G3002235		CTRL PAN TRIM (VGSO166)
55	G9002271AL		CTRL PAN TRIM ASSY XALX
55	G9002271BK		CTRL PAN TRIM ASSY XBKX
55	G9002271BU		CTRL PAN TRIM ASSY XBUX
55	G9002271FG		CTRL PAN TRIM ASSY XFGX
55	G9002271PL		CTRL PAN TRIM ASSY XPLX
55	G9002271VB		CTRL PAN TRIM ASSY XVBX
55	G9002271WH		CTRL PAN TRIM ASSY XWHX
56	G9102266		I/S OVEN LINER ASSY-RH (VGSO166)
57	G9102267		I/S OVEN LINER ASSY-LH (VGSO166)
58	A2002248		CTRL PAN GLASS CLIP (VGSO166)
59	B2002246		SIDE TRIM XSSX (VGSO166)
59	C9002246AL		SIDE TRIM XALX (VGSO166)
59	C9002246BK		SIDE TRIM XBKX (VGSO166)
59	C9002246BU		SIDE TRIM XBUX (VGSO166)
59	C9002246FG		SIDE TRIM XFGX (VGSO166)
59	C9002246PL		SIDE TRIM XPLX (VGSO166)
59	C9002246VB		SIDE TRIM XVBX (VGSO166)
59	C9002246WH		SIDE TRIM XWHX (VGSO166)
60	PJ030004		SELECTOR SWITCH (5-POSITION) VGSO
61	PE050019		OVEN LIGHT SWITCH (VGSO166) 90-DEG.
62	PD010021		P.C. BOARD STAND-OFF (VGSO166)
63	A2002247		TRIM CORNER BRKT (VGSO166)
64	A2002238		BTM TRIM BRKT (VGSO166)
65	PB080003		BROILER PAN TRAY (KRA2)
66	PB080002		BROILER PAN
67	B2002234		LOWER ACC PAN (VGSO166)
67	C9002234AL		LOWER ACC PAN XALX (VGSO166)
67	C9002234BK		LOWER ACC PAN XBKX (VGSO166)
67	C9002234BU		LOWER ACC PAN XBUX (VGSO166)
67	C9002234FG		LOWER ACC PAN XFGX (VGSO166)
67	C9002234PL		LOWER ACC PAN XPLX (VGSO166)
67	C9002234VB		LOWER ACC PAN XVBX (VGSO166)
67	C9002234WH		LOWER ACC PAN XWHX (VGSO166)
NI	PE040036		CONTROL PANEL - BK (BEFORE 9/9/99)
NI	PE040037		CTRL PAN-XWHX VGSO166
NI	PE040097		CTRL PANEL (VGSO166BK) NEW CLOCK
NI	PE040098		CTRL PANEL (VGSO166WH) NEW CLOCK
NI	PA010044		OVEN LIGHT SWITCH KNOB-BK (VGSO166)
NI	PA010046		OVEN LIGHT SWITCH KNOB-WH (VGSO166)
NI	PB010117		SELECTOR KNOB - XBKX (VGSO166)
NI	PB010118		SELECTOR KNOB - XWHX (VGSO166)
NI	PB010115		BIT GENERATOR KNOB - BK
NI	PB010120		BIT GENERATOR KNOB - WH
NI	PB010114		BIT GENERATOR SHAFT XBKX
NI	PB010113		SET BUTTON - BK
NI	PB010119		SET BUTTON XWHX
NI	PB010203	4	WORLD TRONIC CLOCK KNOB XBKX
NI	PB010195	4	WORLDTRONIC CLOCK KNOB XWHX



68 TOP / BOTTOM TRIM

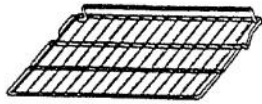

69 OVEN RACK



70 CONTROL PANEL
J-MOLD



71 DUAL THERMAL
CONV. LABEL



72 SIDE
TRIM



73 RACK
SUPT.

Ref #	Part Number	Qty.	Description
68	PE040027		TOP TRIM (VGSO166)
69	PB060038		RACK REPL PB060011
70	PE060010		J-MOLD - 1/2 RAD. VGSO CNTL.PANEL
70	PE060019		J-MOLD (CONTROL PNL TRIM) XBRX
71	PE010015		DUAL THERM. CONV. LABEL - VGSO165
71	PE010067		DUAL THERMAL CONV. PLATE XBRX
72	PE040028		SIDE TRIM (VGSO166)
73	PB060022		OVEN RACK SUPT (VGSO166)

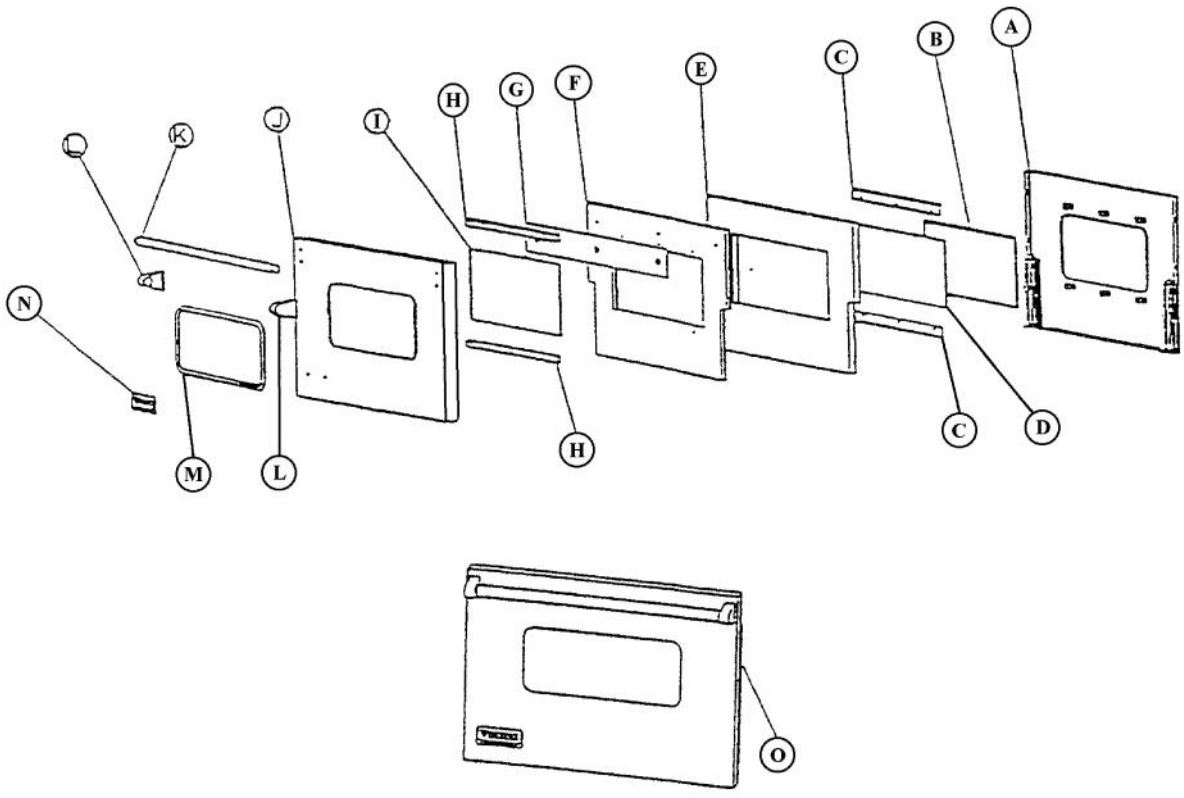

Ref #	Part Number	Qty.	Description
A	G9103414		INSIDE DOOR LINER (VGSO166)
B	PB070014		DOOR GLASS SEAL STRIP - WINDOW DRS.
C	A2001480		INNER DOOR GLASS RETAINER
D	PE060018		OVEN GLASS-TEMPERED,SCREENEDXBKX
E	PB070038		TRS-10 2 X 24 X 3` INSULATION
F	A2003407		DOOR INSUL. PANEL (VGSO166)
G	A1001381		DOOR HEAT BAFFLE (VGSC/VGSS)
H	A2001447		OUTER DOOR GLASS RETAINER
I	PE060018		OVEN GLASS-TEMPERED,SCREENEDXBKX
J	H3002229		O/S DOOR PANEL ASSY XSSX
	H9002270AL		O/S DOOR PANEL ASSY-XALX(VGSO166)
	H9002270BK		O/S DOOR PANEL ASSY-XBKX (VGSO166)
	H9002270BU		O/S DOOR PANEL ASSY-XBUX(VGSO166)
	H9002270FG		O/S DOOR PANEL ASSY-XFGX (VGSO166)
	H9002270PL		O/S DOOR PANEL ASSY-XPLX (VGSO166)
	H9002270VB		O/S DOOR PANEL ASSY-XVBX (VGSO166)
	H9002270WH		O/S DOOR PANEL ASSY-XWHX (VGSO166)
K	PE030031		DOOR HANDLE XSSX (VGSO166)
	PE030032		DOOR HANDLE XBRX (VGSO166) D
L	PE030001		BRACKET, DOOR, HANDLE
	PE030001PVD		END CAP DOOR HANDLE XBR
M	PE060007		J-MOLD (1 RADIUS)
	PE060020		J-MOLD (VGSO OVN DOOR) XBRX
N	PE010016		NAMEPLATE, LOGO, PRO
	PE010017		LOGO (VGSO,VEDO,VGDO,VUD) XWH/CHR
	PE010079		4.5 LOGO/VIKING PROF, BK/BR
	PE010080		4.5 LOGO/VIKING PROF XWH/BR
NI	G3202225AL		DOOR SUB-ASSY-XALX (VGSO166)
	G3202225ALBR		DOOR SUB-ASSY-XALXXBRX (VGSO166)
	G3202225BK		DOOR SUB-ASSY-XBKX (VGSO166)
	G3202225BKBR		DOOR SUB-ASSY-XBKXXBRX (VGSO166)
	G3202225BU		DOOR SUB-ASSY-XBUX (VGSO166)
	G3202225BUBR		DOOR SUB-ASSY-XBKXXBRX (VGSO166)
	G3202225FG		DOOR SUB-ASSY-XFGX(VGSO166)
	G3202225FGBR		DOOR SUB-ASSY-XFGXXBRX (VGSO166)
	G3202225PL		DOOR SUB-ASSY-XPLX (VGSO166)
	G3202225PLBR		DOOR SUB-ASSY-XPLXXBRX (VGSO166)
	G3202225SS		DOOR SUB-ASSY-XSSX (VGSO166)
	G3202225SSBR		DOOR SUB-ASSY-XSSXXBRX (VGSO166)
	G3202225VB		DOOR SUB-ASSY-XVBX.(VGSO166)
	G3202225VBBR		DOOR SUB-ASSY-XVBXXBRX (VGSO166)
	G3202225WH		DOOR SUB-ASSY-XWHX (VGSO166)
	G3202225WHBR		DOOR SUB-ASSY-XWHXXBRX (VGSO166)

VGSO166 – Gas tube identification

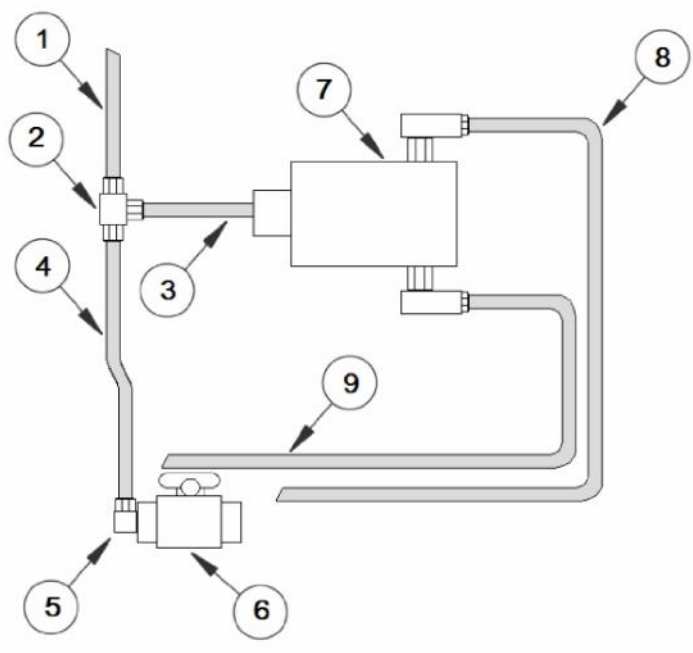

Ref #	Part Number	Qty.	Description
1	PB020057		TUBING-BROIL VALVE (VGSO166)
2	PB040045		3/8 UNION TEE (VGSO166)
3	PB020058		TUBING-BROIL VALVE (VGSO166)
4	PB020056		TUBING-SUPPLY (VGSO166)
5	PB040044		90-DEG. MALE ELBOW
6	PB030006		SHUT-OFF VALVE (VGSO166)
7	PB010084		DUAL THERMAL BI-MTL GAS CTRL VALVE
8	PB020054		TUBING-BAKE RH (VGSO166)
9	PB020055		TUBING-BAKE LH (VGSO166)