

This Owner's Manual is provided and hosted by [Appliance Factory Parts](#).

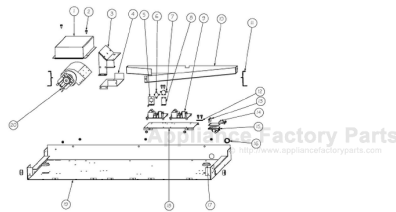

VIKING VGCC536-4G Owner's Manual

**Shop genuine replacement parts for VIKING
VGCC536-4G**



[Find Your VIKING Range Hoods Parts - Select From 411 Models](#)

----- Manual continues below -----

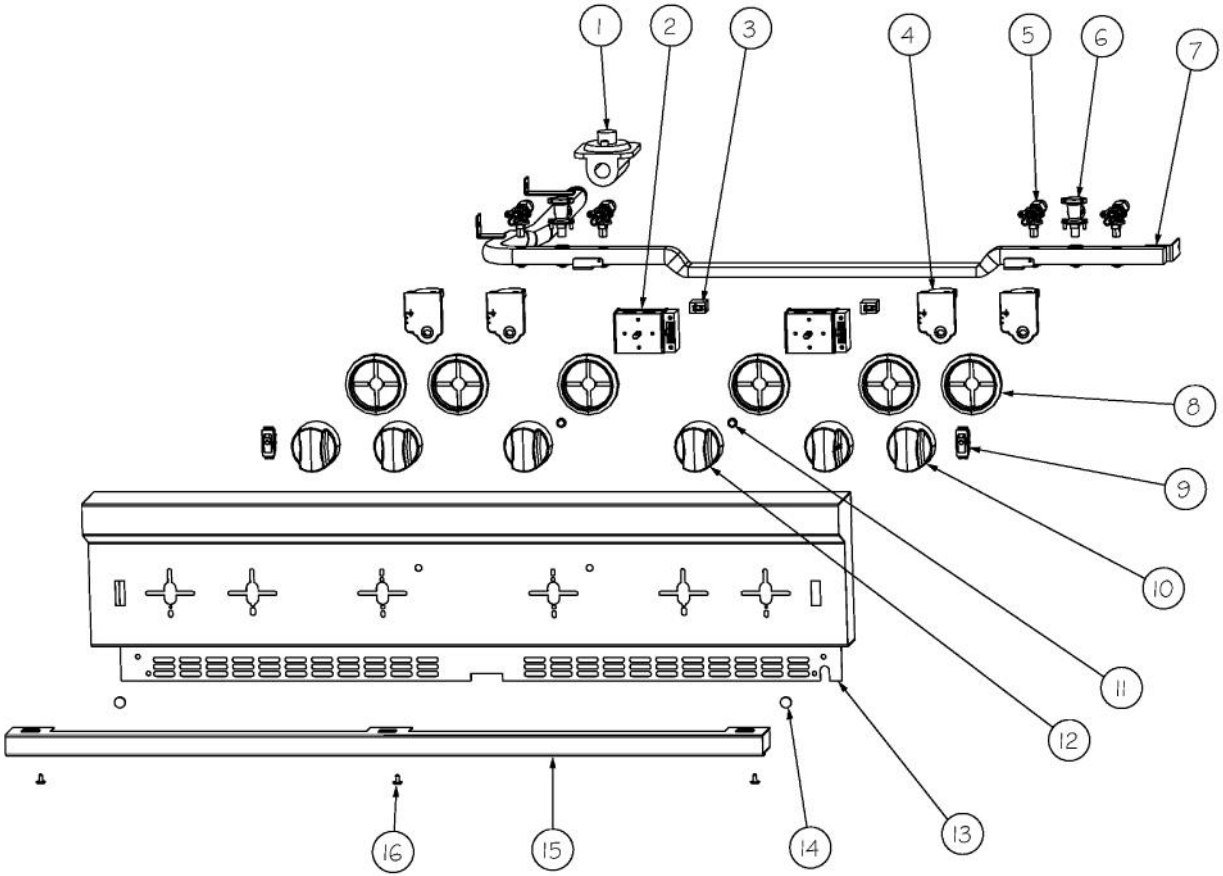

Ref #	Part Number	Qty.	Description
1	PA070001	1	PRESSURE REGULATOR (NAT.)
1	000714-000	1	LP REGULATOR
2	038413-000	2	TSTAT, SMPS, ELEC, 2-POS, .91 SHAFT, CB
3	PE050024	2	OVEN IND. LIGHT (LIGHT HOUSING)
4	PA020058	4	IRIS SINGLE SPARK MODULE
5	006015-000	4	VALVE, BRS, SEALED TOP - ISPHORDING
6	PB030007	2	SHUT OFF VALVE
7	012830-000	1	MANIFOLD, VG536-4G
8	PB010304	6	KNOB BEZEL
9	006355-000	2	SPLASHPROOF ROCKER SWITCH
10	005269-000	4	RANGE TOP BURNER KNOB-BRUSHED, SSS BEFORE 12/20/12
10	035881-000	4	KNOB, BNR, TOP PRO CR3 AFTER (12/20/12)
11	PE050023	2	OVEN IND. LIGHT (LENS & BEZEL)
12	006570-000	2	KNOB, GRDL/(LH OVEN), ASM, PVD, NO.3, SSS BEFORE 12/20/12
12	035883-000	2	KNOB, GRDL, PRO CR3 AFTER (12/20/12)
13	006617-000	1	CONTROL, PNL, VGCC536-4G, ASM
14	PD040004	2	GROMMET BUMPER
15	011637-000	1	TRIM, ASM
16	PD020032	3	SRW-8(A)X3/8PH.WFR HD 7/16DIAXNICL
NI	008416-000	1	KNOB, THERMOSTAT, NO.3 SSS, ASM, VGCC BEFORE 12/20/12
NI	035891-000	1	KNOB, OVN, TSTAT, PRO VGCC CR3 AFTER (12/20/12)

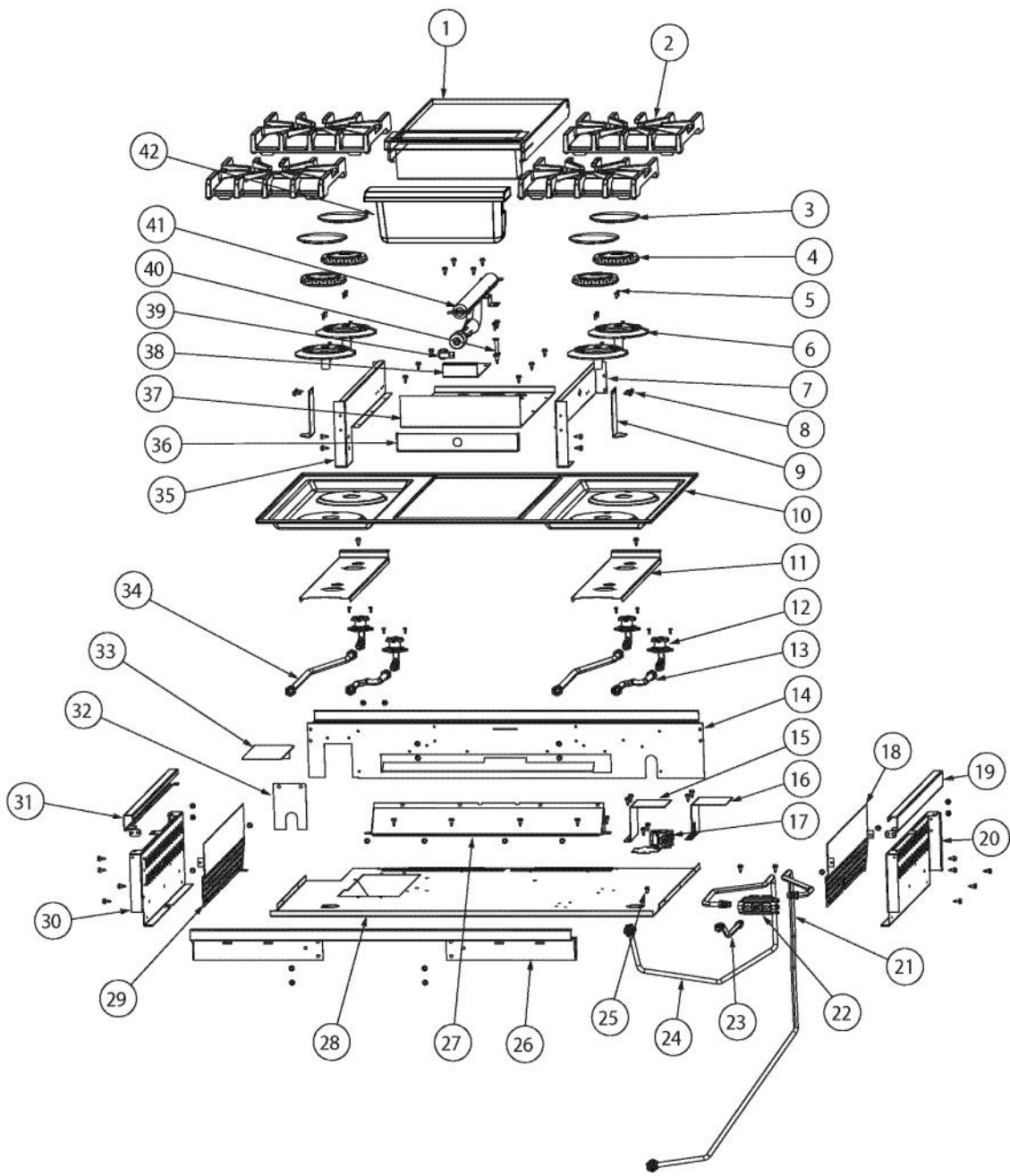

Ref #	Part Number	Qty.	Description
1	012291-000	1	GRIDDLE ASM, CUSTOM RANGES
2	007323-000	4	BURNER GRATE
3	PA080083	3	D BURNER CAP XMATTE BLACKX
4	006706-000	4	B6 REV SEALED BURNER
5	PD020076	8	6-32 X 3/8 PHILL PAN MS
6	003322-041	4	SEALED BURNER BASE, PAINTED FINISH
7	009097-000	1	RIGHT GRIDDLE SUPPORT, 36
8	003860-000	48	NO.10-18 X .500 FASTNR,SCR,HXWH,STL,ZPLT
9	010649-000	2	FOOT, GRIDDLE BOX , VG536-4G
10	E9108438BK	1	MAIN TOP (VGRT4G/Q) XBKX
11	002923-000	2	BURNER MODULE SUPPORT
12	001394-042	4	15000 BTU NAT JETHOLDER
13	001394-046	2	12.5 K BTU LP JETHOLDER
13	PB020192	2	10 FLEX TUBING W/CONNECTORS
14	008278-000	1	BURNER BOX BACK SUPPORT
15	009402-000	1	SOLENOID HEAT SHIELD COVER
16	011076-000	1	SHIELD, HEAT, VALVE W/TUBE
17	009111-000	1	VALVE, SOL, SINGLE
18	010901-000	1	SHIELD, HEAT, GRIDDLE
19	002920-000	1	SIDE TRIM, RH - STAINLESS
20	011077-000	1	SHIELD, HEAT, GRIDDLE, RH
21	009053-000	1	BAKE TUBING, 36
22	012654-000	1	TUBING, BAKE, 36 ASSY (LP)
22	009112-000	1	VALVE, SOL, DOUBLE
23	011035-000	1	OVEN TUBING ASM
24	009055-000	1	BROIL TUBING, 36
25	PD020010	1	10 X 3/8 GREEN GROUNDING SCREW
26	008279-000	1	BURNER BOX FRONT SUPPORT
27	008283-000	1	BACK VENT, 36
28	PB070058	1	COOKTOP GASKET-(VGSU101)
29	010902-000	1	SHIELD, HEAT, GRIDDLE
30	011078-000	1	PANEL, RNG, GRIDDLE, LF
31	003649-000	1	SIDE TRIM, LH - STAINLESS
32	006687-000	1	REGULATOR COVER PLATE
33	004016-000	1	PLATE,SVCE,RGLT
34	PB020193	2	16 FLEX TUBING W/CONNECTORS
35	009096-000	1	LEFT GRIDDLE SUPPORT, 36
36	006783-000	1	GRIDDLE BRKT, ORIFICE, CUSTOM RANGES
37	013953-000	1	GRIDDLE, BOX, BOTTOM, CUSTOM G RANGES
38	006785-000	1	GRIDDLE, BOX, VENTURI, COVER
39	PB040190	1	90 DEGREE ORIFICE FITTING NO.50 NAT
40	002513-000	1	90 DEGREE ORIFICE FITTING NO.57 LP
40	PA020028	1	SPARK IGNITER
41	013888-000	1	GRIDDLE, BURNER, ASM, NAT, W/IGNITOR BRACKET
41	013889-000	1	GRIDDLE, BURNER, ASM, LP, W/IGNITOR BRACKET
42	012165-700	1	TROUGH, GRS, ASM, COATED
NI	013408-000	1	GRIDDLE HEADER

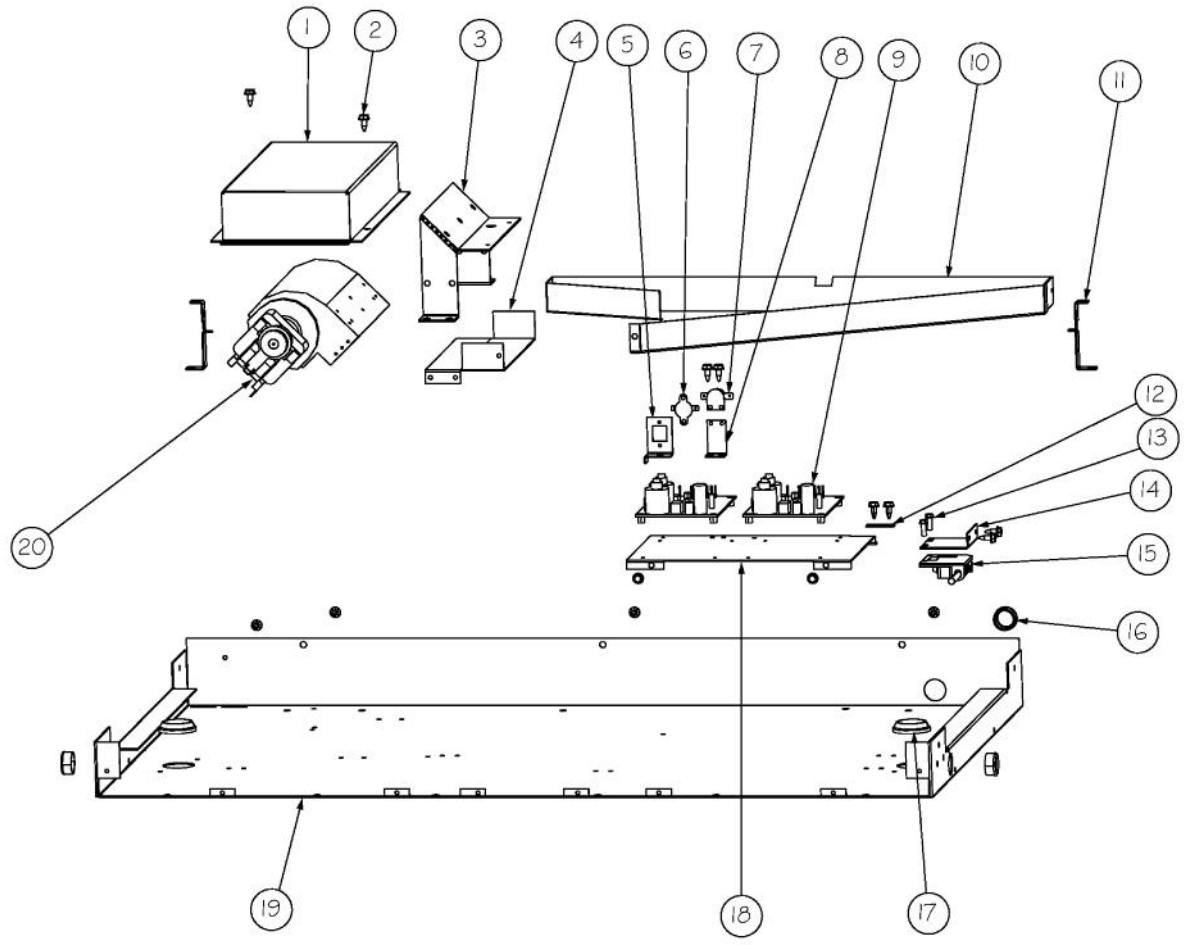

Ref #	Part Number	Qty.	Description
1	008747-000	1	FAN COVER
2	003860-000	12	NO.10-18 X .500 FASTNR,SCR,HXWH,STL,ZPLT
3	009307-000	1	36 MTG BRACKET
4	012569-000	1	BRACKET, LOWER FAN
5	012438-000	1	SWITCH, LIM, BRKT
6	PJ030022	1	HIGH LIMIT SWITCH
7	PJ030039	1	BI-METAL THERMOSTAT 275 DEGREES
8	A20014089	1	DISC BRACKET
9	PA020056		TYTRONICS DSI MODULE (BEFORE 12/01/10)
	023651-000	2	DSI120 LONG PURGE (ON OR AFTER 12/01/10)
10	012567-000	1	DUCT, FAN, 36
11	009288-000	1	36 FAN BRACKET
12	008012-000	1	BOARD CLIP
13	PD020060	2	10 X 1/2 (5/16)HEX WSHR HD.(T)A
14	A20012649	1	DOOR SWITCH BRACKET
15	PE050208	1	DOOR SWITCH
16	PD040005	3	SNAP BUSHING - 7/8
17	PB070079	2	SILICONE EXTRUSION (DGSU)
18	012571-000	1	PLATE, CONTROL MTG (BEFORE 12/20/10)
18	008011-000	1	36 ELECTRONIC PLATE (ON OR AFTER 12/20/10)
19	007842-000	1	TOP CAP, 36
20	PE050250	1	PREMIUM BLOWER WITH HES

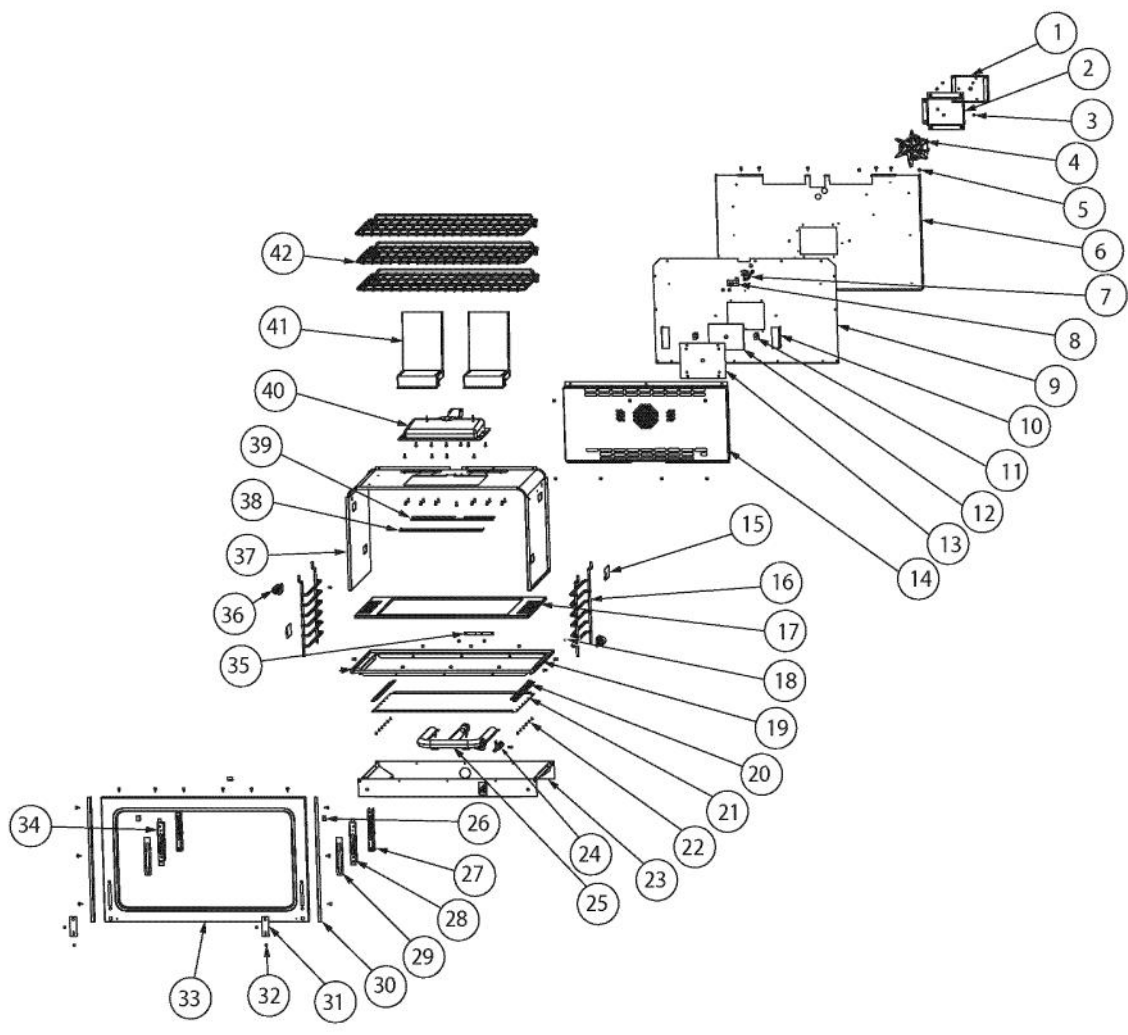

Ref #	Part Number	Qty.	Description
1	A2002595	1	CONVECTION FAN BOX (VDSC)
2	A2008467	1	INSULATION SHIELD
3	PD020060	52	10 X 1/2 (5/16)HEX WSHR HD.(T)A
4	PE050057	1	CONVECTION FAN (VGSC306) (BEFORE 8/31/11)
NI	023090-000	1	MOTOR, CONV ASM? (ON OR AFTER 8/31/13)
5	003860-000	19	NO.10-18 X .500 FASTNR,SCR,HXWH,STL,ZPLT
6	007841-000	1	BACK INSULATION PANEL, 36
7	PB040171	1	BROIL IGNITION ELECTRODE
8	007008-000	1	RTD PROBE
9	NON REPLACEABLE	N/A	OVEN CAVITY, 36 (G30014040)
10	E2004435	2	CONVECTION FAN BAFFLE (VGSC306)
11	A2001361	2	BACK SPACER (VGSC/VGSS)
12	PB070208	1	CONVECTION FAN INSULATION
13	A1002596	1	CONVECTION FAN COVER (VDSC)
14	021225-402	1	COVER, CNVN, ASM, BK PORC (UNITS WITH BLACK PORC.)
14	021225-403	1	COVER, CNVN, ASM, GY PORC (UNITS WITH GREY PORC.)
15	E91012614	2	LIGHT HOLE COVER
16	PB060030	2	RACK SUPT REPL PB060010
17	E2105524	1	OVEN BOTTOM
18	PD020067	2	NO.6 X 3/8 PAN PHIL. TEK SS
19	005264-000	1	BOTTOM LINER, 36
20	E2004433	2	OVEN BOTTOM BRACE (VGSC306)
21	A2005525	1	OVEN BOTTOM HEAT SHIELD
22	PD020084	12	6-32 X 1/4 PAN PHIL TYPE F XSSX
23	NON REPLACEABLE	N/A	OVEN CAVITY, 36 (G30014040)
24	PB040170	1	BAKE IGNITION ELECTRODE
25	008191-000	1	OVEN BURNER ASSY
25	009150-000	1	OVEN BURNER ASSY XLPX
26	006050-000	3	BRACKET, FR, FRONT
27	031679-000	2	RECEPTACLE, HINGE
28	E2109638	1	BRACKET, HINGE RECPT RH
29	007259-000	2	SHIM
30	005536-000	2	TRIM
31	007278-000	2	ARM HINGE CLIP
32	PD020232	2	NO.8 X 3/4 PH PAN HEAD TEK SCREW (BLACK OXIDE)
33	007844-000	1	FRONT FRAME, 36
34	NON REPLACEABLE	N/A	OVEN CAVITY, 36 (G30014040)
35	A2004428	1	REAR BOTTOM BRCKT (VGSC306) (BEFORE 8/31/11)
36	PE050238	2	120 VOLT SIDE HALOGEN LIGHT
37	NON REPLACEABLE	N/A	OVEN CAVITY, 36 (G30014040)
38	B2002261	1	FRONT I/R BROILER SUPPORT BRACKET
39	B2005589	1	REAR BROILER BRACKET
40	G3001876	1	IR BURNER ASSY (VGSC/RC) N/S
41	006192-000	2	VENT, ASM, OVEN ASSEMBLY
42	PB060045	3	OVEN RK VDSC36 REPL PB060020

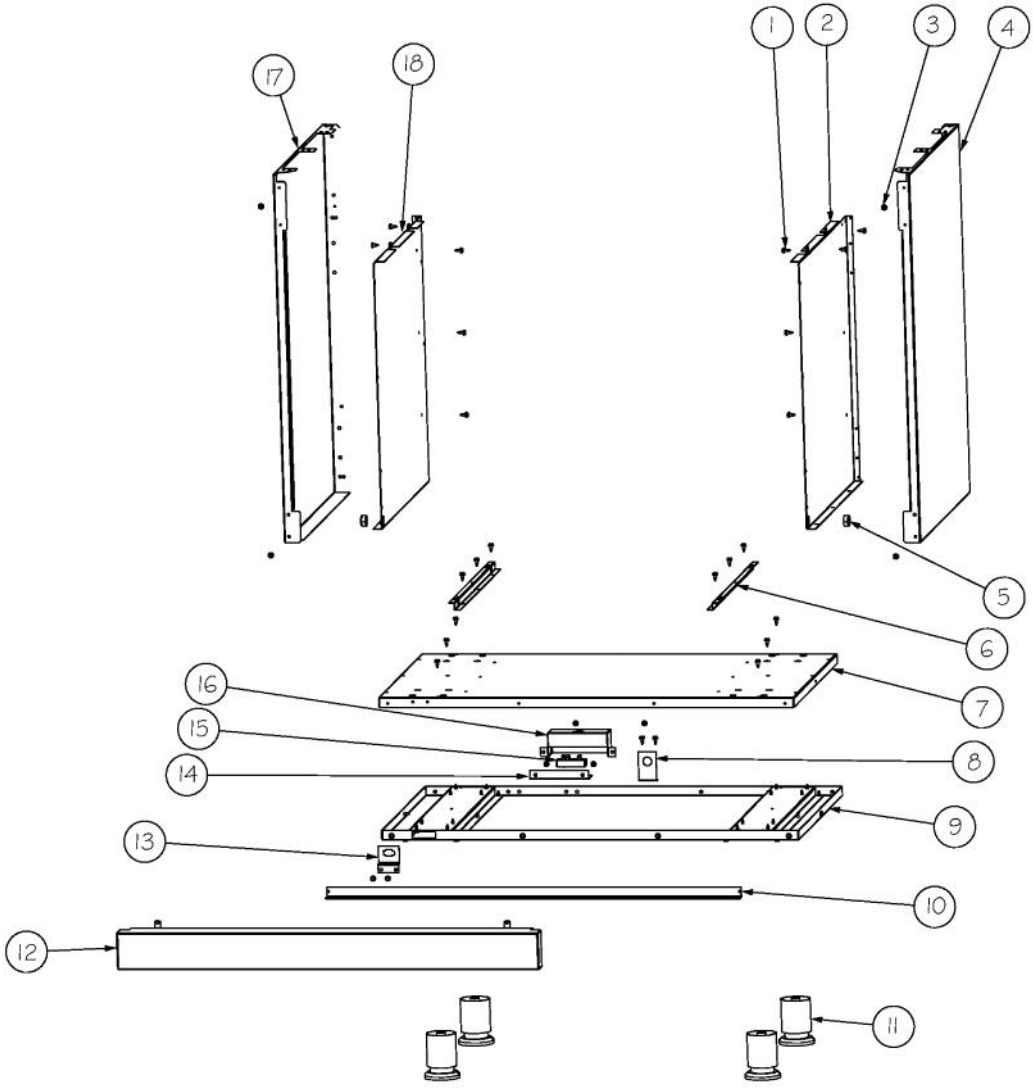

Ref #	Part Number	Qty.	Description
1	003860-000	29	NO.10-18 X .500 FASTNR,SCR,HXWH,STL,ZPLT
2	004479-000	1	INSULATION, PNL, SIDE, RH
3	003801-000	4	SHOULDER SCREW, NO.10
4	002905-000	1	SIDE PANEL, RH, SST
4	004645-002	1	SIDE PANEL, RH,-BK
4	004645-003	1	SIDE PANEL, RH,-BT
4	004645-004	1	SIDE PANEL, RH,-SG
4	004645-005	1	SIDE PANEL, RH,-GG
4	004645-006	1	SIDE PANEL, RH,-WH
4	004645-007	1	SIDE PANEL, RH,-AL
4	004645-008	1	SIDE PANEL, RH,-BU
4	004645-009	1	SIDE PANEL, RH,-LE
4	004645-010	1	SIDE PANEL, RH,-MJ
4	004645-011	1	SIDE PANEL, RH,-FG
4	004645-012	1	SIDE PANEL, RH,-VB
4	004645-013	1	SIDE PANEL, RH,-CB
4	004645-014	1	SIDE PANEL, RH,-EP
4	004645-015	1	SIDE PANEL, RH,-PL
4	004645-016	1	SIDE PANEL, RH,-CH
4	004645-017	1	SIDE PANEL, RH,-TP
4	004645-018	1	SIDE PANEL, RH,-CW
4	004645-019	1	SIDE PANEL, RH,-OG
4	004645-020	1	SIDE PANEL, RH,-GM
4	004645-021	1	SIDE PANEL, RH,-SA
4	004645-022	1	SIDE PANEL, RH,-SE
4	004645-023	1	SIDE PANEL, RH,-IB
4	004645-024	1	SIDE PANEL, RH,-AR
4	004645-025	1	SIDE PANEL RH - RR
4	004645-026	1	SIDE PANEL, RH,-PM
4	004645-027	1	SIDE PANEL, RH,-MS
5	PD040005	2	SNAP BUSHING - 7/8
6	A2004429	2	OVEN BOTTOM INSUL. BRACE (VGSC306)
7	020604-000	1	BASE, RANGE
8	005529-000	1	BAKE ORIFICE MTG BRKT (BEFORE 2/11/13)
8	040736-000		BRKT, ORF (ON OR AFTER 2/11/13)
9	007817-000	1	VGCC/SC BASE ASSEMBLY, 36
10	008345-000	1	BOTTOM SUPPORT, 36
11	PC030031	4	ADJUSTABLE LEG
12	007851-000	1	VGCC/SC 536 KICKPLATE SS
12	011522-002	1	VGCC/SC 536 KICKPLATE - BK
12	011522-003	1	VGCC/SC 536 KICKPLATE - BT
12	011522-004	1	VGCC/SC 536 KICKPLATE - SG
12	011522-005	1	VGCC/SC 536 KICKPLATE - GG
12	011522-006	1	VGCC/SC 536 KICKPLATE - WH
12	011522-007	1	VGCC/SC 536 KICKPLATE - AL
12	011522-008	1	VGCC/SC 536 KICKPLATE - BU
12	011522-009	1	VGCC/SC 536 KICKPLATE - LE
12	011522-010	1	VGCC/SC 536 KICKPLATE -MJ
12	011522-011	1	VGCC/SC 536 KICKPLATE - FG
12	011522-012	1	VGCC/SC 536 KICKPLATE - VB
12	011522-013	1	VGCC/SC 536 KICKPLATE - CB
12	011522-014	1	VGCC/SC 536 KICKPLATE - EP
12	011522-015	1	VGCC/SC 536 KICKPLATE - PL
12	011522-016	1	VGCC/SC 536 KICKPLATE - CH
12	011522-017	1	VGCC/SC 536 KICKPLATE - TP
12	011522-018	1	VGCC/SC 536 KICKPLATE - CW
12	011522-019	1	VGCC/SC 536 KICKPLATE - OG
12	011522-020	1	VGCC/SC 536 KICKPLATE - GM

Ref #	Part Number	Qty.	Description
12	011522-020	1	VGCC/SC 536 KICKPLATE - GM
12	011522-021	1	VGCC/SC 536 KICKPLATE - SA
12	011522-022	1	VGCC/SC 536 KICKPLATE - SE
12	011522-023	1	VGCC/SC 536 KICKPLATE - IB
12	011522-024	1	VGCC/SC 536 KICKPLATE - AR
12	011522-025	1	VGCC/SC 536 KICKPLATE - RR
12	011522-026	1	VGCC/SC 536 KICKPLATE - PM
12	011522-051	1	VGCC/SC 536 KICKPLATE-CN
12	011522-052	1	VGCC/SC 536 KICKPLATE-DJ
12	011522-053	1	VGCC/SC 536 KICKPLATE-KB
12	011522-054	1	VGCC/SC 536 KICKPLATE-WS
12	011522-027	1	VGCC/SC 536 KICKPLATE - MS
13	005280-000	1	DISCONNECT BRKT
14	007484-000	1	TERMINAL, BLOCK, BRACKET
15	007400-000	1	BLOCK, TERMINAL
16	031961-000	1	COVER, TERM. BLOCK
17	003588-000	1	SIDE PANEL, LH
17	005505-002	1	SIDE PANEL, LH BK
17	005505-003	1	INSULATION, PNL, SIDE, LH - BT
17	005505-004	1	INSULATION, PNL, SIDE, LH - SG
17	005505-005	1	INSULATION, PNL, SIDE, LH - GG
17	005505-006	1	INSULATION, PNL, SIDE, LH - WH
17	005505-007	1	INSULATION, PNL, SIDE, LH - AL
17	005505-008	1	INSULATION, PNL, SIDE, LH - BU
17	005505-009	1	INSULATION, PNL, SIDE, LH - LE
17	005505-010	1	INSULATION, PNL, SIDE, LH - MJ
17	005505-011	1	INSULATION, PNL, SIDE, LH - FG
17	005505-012	1	INSULATION, PNL, SIDE, LH - VB
17	005505-013	1	INSULATION, PNL, SIDE, LH - CB
17	005505-014	1	INSULATION, PNL, SIDE, LH - EP
17	005505-015	1	INSULATION, PNL, SIDE, LH - PL
17	005505-016	1	INSULATION, PNL, SIDE, LH - CH
17	005505-017	1	INSULATION, PNL, SIDE, LH - TP
17	005505-018	1	INSULATION, PNL, SIDE, LH - CW
17	005505-019	1	INSULATION, PNL, SIDE, LH - OG
17	005505-020	1	INSULATION, PNL, SIDE, LH - GM
17	005505-021	1	INSULATION, PNL, SIDE, LH - SA
17	005505-022	1	INSULATION, PNL, SIDE, LH - SE
17	005505-023	1	INSULATION, PNL, SIDE, LH - IB
17	005505-024	1	INSULATION, PNL, SIDE, LH - AR
17	005505-025	1	SIDE PANEL LH - RR
17	005505-026	1	INSULATION, PNL, SIDE, LH - PM
17	005505-027	1	INSULATION, PNL, SIDE, LH - MS
18	004482-000	1	INSULATION, PNL, SIDE, LH

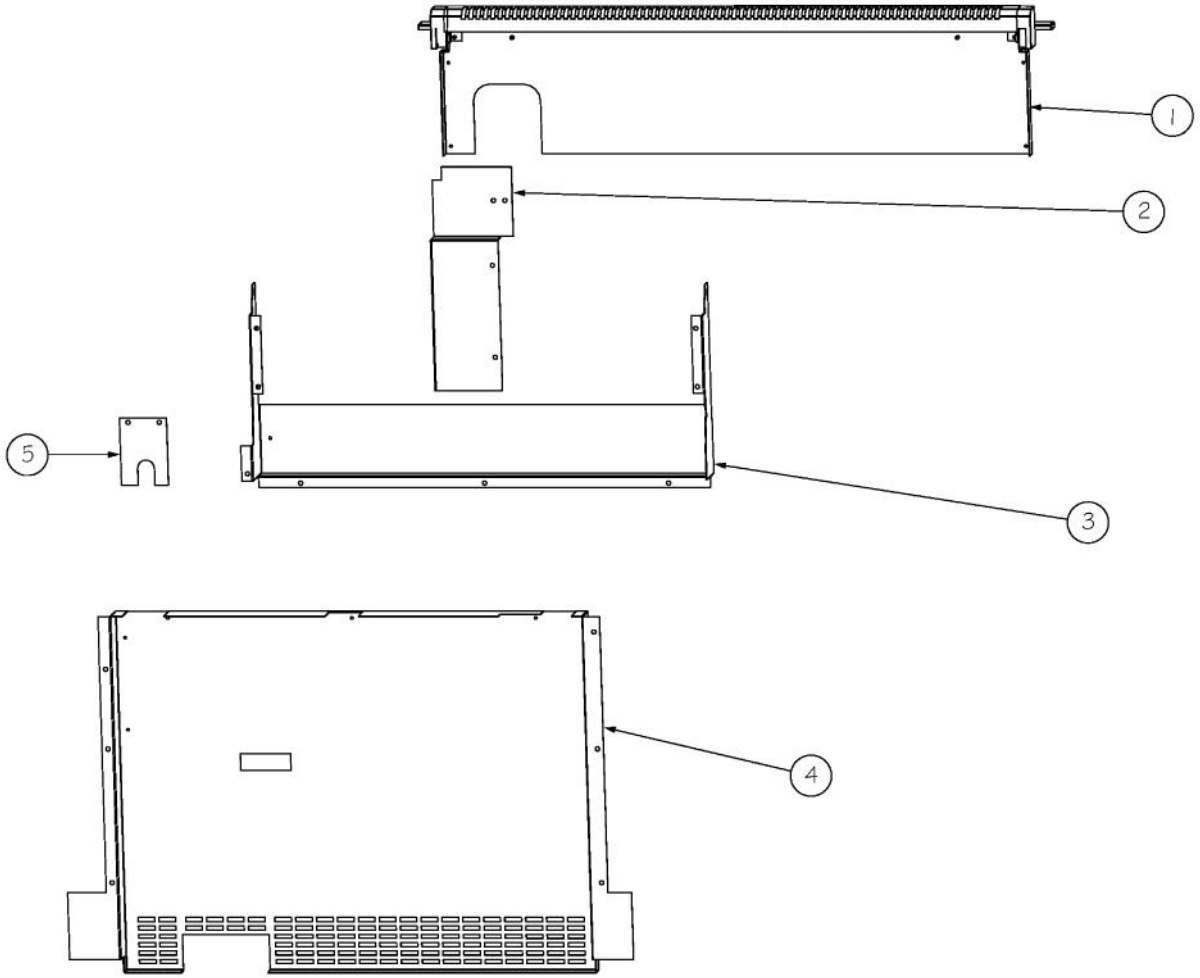

Ref #	Part Number	Qty.	Description
1	006900-000	1	ISLAND TRIM, ASM, 36 CUSTOM
2	006962-000	1	COVER, INL, BACK
3	024722-000	1	COVER, BACK, TOP,36
4	032138-000	1	COVER, REAR, 36 NON-SELF-CLEAN
5	006687-000	1	REGULATOR COVER PLATE

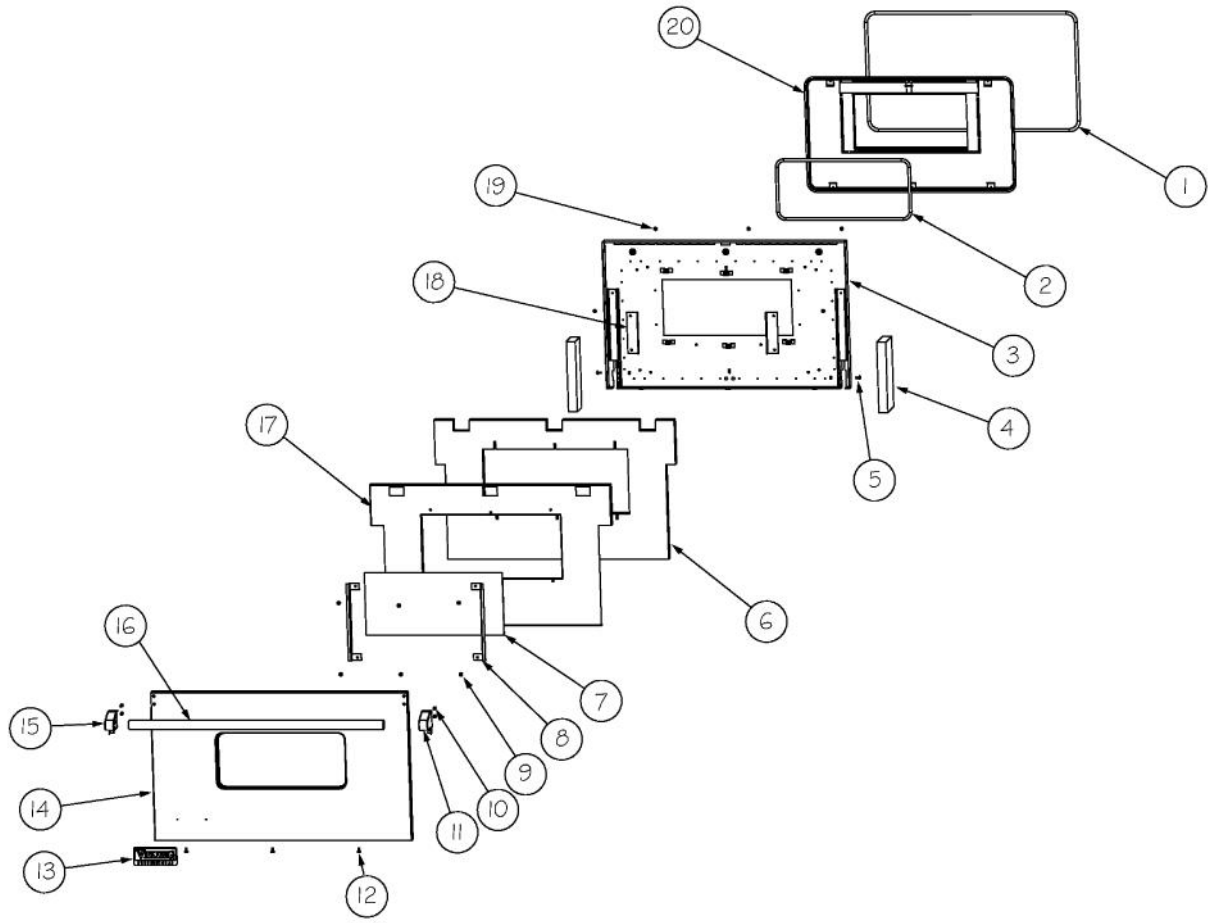

Ref #	Part Number	Qty.	Description
1	000090-000	1	36 DOOR GASKET
2	000594-000	1	BLACK FIBERGLASS ROPE 3/8
3	008154-000	1	36 DOOR LINER WELD ASM
4	006999-000	2	HINGE, DOOR, VDSC36 - ORANGE SPRING
5	PD010003	2	10-24 X 1/2 PH.TR.HD.SERD.M.S.
6	007854-000	1	DOOR LINER INSULATION
7	PE060030	1	GLASS-OUTER DOOR BK SCREENED,TEMP
8	007583-000	1	BRACKET, GLASS
9	PD020014	6	10X3/4 PH TR HD SMS
10	002736-000	4	NO.10-32 PAN HEAD PHILLIPS MACHINE SCREW
11	003012-000	1	DOOR HANDLE ENDCAP ASSY, RH (CHROME)
11	003012-100	1	DOOR HANDLE ENDCAP ASSY, RH (BRASS)
12	PD020033	3	SRW-NO.10-24X1/2T(23)PH.WFR HD (NKL)
13	PE010030	1	LOGO, 6, PRO, BK
13	PE010068	1	LOGO, 6, PRO, BK/BR
14	008166-000	1	PANEL, DOOR, ASM, OTR, GSC, SS
14	020693-002	1	SRV DOOR SKIN KIT, 36 BK, VGSC, VGCC
14	020693-003	1	SRV DOOR SKIN KIT, 36 BT, VGSC, VGCC
14	020693-004	1	SRV DOOR SKIN KIT, 36 SG, VGSC, VGCC
14	020693-005	1	SRV DOOR SKIN KIT, 36 GG, VGSC, VGCC
14	020693-006	1	SRV DOOR SKIN KIT, 36 WH, VGSC, VGCC
14	020693-008	1	SRV DOOR SKIN KIT, 36 BU, VGSC, VGCC
14	020693-009	1	SRV DOOR SKIN KIT, 36 LE, VGSC, VGCC
14	020693-010	1	SRV DOOR SKIN KIT, 36 MJ, VGSC, VGCC
14	020693-012	1	SRV DOOR SKIN KIT, 36 VB, VGSC, VGCC
14	020693-013	1	SRV DOOR SKIN KIT, 36 CB, VGSC, VGCC
14	020693-015	1	SRV DOOR SKIN KIT, 36 PL, VGSC, VGCC
14	020693-016	1	SRV DOOR SKIN KIT, 36 CH, VGSC, VGCC
14	020693-017	1	SRV DOOR SKIN KIT, 36 TP, VGSC, VGCC
14	020693-018	1	SRV DOOR SKIN KIT, 36 CW, VGSC, VGCC
14	020693-019	1	SRV DOOR SKIN KIT, 36 OG, VGSC, VGCC
14	020693-020	1	SRV DOOR SKIN KIT, 36 GM, VGSC, VGCC
14	020693-021	1	SRV DOOR SKIN KIT, 36 SA, VGSC, VGCC
14	020693-022	1	SRV DOOR SKIN KIT, 36 SE, VGSC, VGCC
14	020693-023	1	SRV DOOR SKIN KIT, 36 IB, VGSC, VGCC
14	020693-024	1	SRV DOOR SKIN KIT, 36 AR, VGSC, VGCC
14	020693-025	1	SRV DOOR SKIN KIT, 36 RR, VGSC, VGCC
14	020693-026	1	SRV DOOR SKIN KIT, 36 PM, VGSC, VGCC
14	020693-027	1	SRV DOOR SKIN KIT, 36 MS, VGSC, VGCC
14	020693-051	1	SRV DOOR SKIN KIT, 36 CN, VGSC, VGCC
14	020693-052	1	SRV DOOR SKIN KIT, 36 DJ, VGSC, VGCC
14	020693-053	1	SRV DOOR SKIN KIT, 36 KB, VGSC, VGCC
14	020693-054	1	SRV DOOR SKIN KIT, 36 WS, VGSC, VGCC
15	003011-000	1	DOOR HANDLE ENDCAP ASSY, LH (CHROME)
15	003011-100	1	DOOR HANDLE ENDCAP ASSY, LH (BRASS)
16	006080-000	1	36 DOOR HANDLE, SST
17	007883-000	1	RETAINER LINER, 36
18	A2002189	2	DOOR GLASS STANDOFF (VDSC)
19	PD020063	4	SCREW-NO.8(A) X 3/8PH WFR HD/BK OXID
20	008165-000	1	DOOR PLUG ASSY, 36
NI	011524-002	1	COMPLETE DOOR ASM - BK
NI	011524-003	1	COMPLETE DOOR ASM - BT
NI	011524-004	1	COMPLETE DOOR ASM - SG
NI	011524-005	1	COMPLETE DOOR ASM - GG
NI	011524-006	1	COMPLETE DOOR ASM - WH
NI	011524-007	1	COMPLETE DOOR ASM - AL
NI	011524-008	1	COMPLETE DOOR ASM - BU
NI	011524-009	1	COMPLETE DOOR ASM - LE
NI	011524-010	1	COMPLETE DOOR ASM - MJ
NI	011524-011	1	COMPLETE DOOR ASM - FG

Ref #	Part Number	Qty.	Description
NI	011524-011	1	COMPLETE DOOR ASM - FG
NI	011524-012	1	COMPLETE DOOR ASM - VB
NI	011524-013	1	COMPLETE DOOR ASM - CB
NI	011524-014	1	COMPLETE DOOR ASM - EP
NI	011524-015	1	COMPLETE DOOR ASM - PL
NI	011524-016	1	COMPLETE DOOR ASM - CH
NI	011524-017	1	COMPLETE DOOR ASM - TP
NI	011524-018	1	COMPLETE DOOR ASM - CW
NI	011524-019	1	COMPLETE DOOR ASM - OG
NI	011524-020	1	COMPLETE DOOR ASM - GM
NI	011524-021	1	COMPLETE DOOR ASM - SA
NI	011524-022	1	COMPLETE DOOR ASM - SE
NI	011524-023	1	COMPLETE DOOR ASM - IB
NI	011524-024	1	COMPLETE DOOR ASM - AR
NI	011524-025	1	COMPLETE DOOR ASM - RR
NI	011524-026	1	COMPLETE DOOR ASM - PM
NI	011524-027	1	COMPLETE DOOR ASM - MS

*No Image
Available*

Ref #	Part Number	Qty.	Description
NI	010918-000	1	WIRE HARNESS, VGCC536-4G
NI	011097-000	2	HARNESS,W,GRIDDLE THERMOSTAT,VGSC536-4G
NI	013408-000	1	GRIDDLE HEADER
NI	001134-000	2	IRIS HARNESS INSULATED CAP
NI	025991-000	1	HARNESS, WIRE, VGCC536-4G
NI	023340-000	1	IRIS HARNESS, 36
NI	024605-000	1	WIRE, BRL, ELECTRODE, ASM
NI	024606-000	1	WIRE, BAKE, ELECTRODE, ASM
NI	023750-000	1	CORD, SUPPLY
NI	035604-000	1	VGCC536 SERVICE DISCONNECT KIT
NI	043834-000	1	36 SPILL GUTTER KIT 2 (FOR UNITS MANUFACTURED BEFORE 1/9/13)
NI	000647-000	2	IRIS IGNITOR WIRE, FRONT BURNER
NI	006766-000	2	IRIS IGNITOR WIRE, BACK BURNER
NI	015357-000	2	IGNITOR, W/WIRE