

This Owner's Manual is provided and hosted by [Appliance Factory Parts](#).

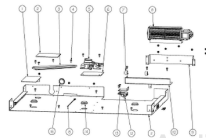

VIKING VDSC536T-4Q Owner's Manual

**Shop genuine replacement parts for VIKING
VDSC536T-4Q**



Appliance Factory Parts
© http://www.appliancefactoryparts.com

[Find Your VIKING Range Hoods Parts - Select From 411 Models](#)

----- Manual continues below -----

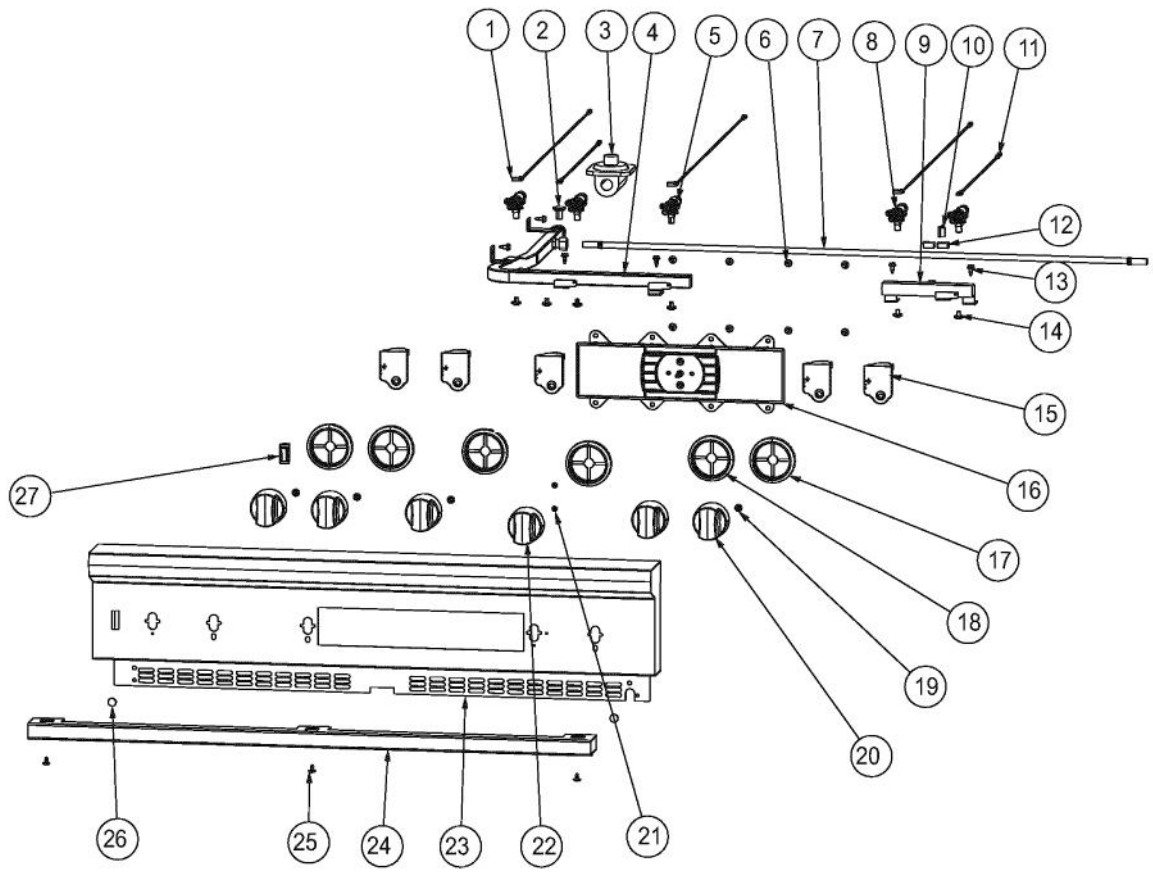

Ref #	Part Number	Qty.	Description
1	006766-000	1	IRIS IGNITOR WIRE, BACK BURNER
2	002884-000	1	MANIFOLD PLUG
3	PA070001	1	PRESSURE REGULATOR (NAT.)
3	00714-000	1	PRESSURE REGULATOR (LP)
4	019448-000	1	MANIFOLD, GAS, ASM, LH
4	020628-000	1	MANIFOLD ASM, VLV, LH, LP
5	013583-000	1	VALVE, GRL, ASM, BRS, ISPHORDING
6	PD010003	8	10-24 X 1/2 PH.TR.HD.SERD.M.S.
7	PB020112	1	3/8 SS FLEX TUBING - 36 T6-36
8	006015-000	4	VALVE, BRS, SEALED TOP - ISPHORDING
9	013997-000	1	GAS MANIFOLD RH, VDSC530T
10	PE070889	1	IRIS HARNESS - 30
11	000647-000	1	IRIS IGNITOR WIRE, FRONT BURNER
12	001134-000	2	IRIS HARNESS INSULATED CAP
13	003860-000	5	NO.10-18 X .500 FASTNR,SCR,HXWH,STL,ZPLT
14	PD010012	6	VALVE BOLT 1/4-20 UNC-2B 5/16 M.S.
15	PA020058	5	IRIS SINGLE SPARK MODULE
16	013995-000	1	VDSC ELECTRONIC CONTROLS MODULE
17	PB010304	4	KNOB BEZEL
17	PB010305PVD	5	KNOB BEZEL, BRASS
18	010348-000	2	KNOB BEZEL,VDSC, ELECTRONIC CONTROLS, SSS
18	010348-100	2	KNOB BEZEL,VDSC, ELEC CONTROLS (BR)
19	PD020046	4	NO.8 X 1/2 SCREWS
20	005269-000	5	RANGE TOP BURNER KNOB-BRUSHED, SSS
21	PD020062	2	NO.8-32 X 3/8 PHMS TYPE 1
22	013950-000	1	OVEN KNOB, VDSC ELECTRONIC CONTROLS
23	017336-000	1	CONTROL PANEL ASM, VDSC536T-4Q
24	011637-000	1	TRIM, ASM
25	PD020032	3	SRW-8(A)X3/8PH.WFR HD 7/16DIAXNICL
26	PD040004	2	GROMMET BUMPER
27	003719-000	1	OVEN LIGHT SWITCH, BLACK

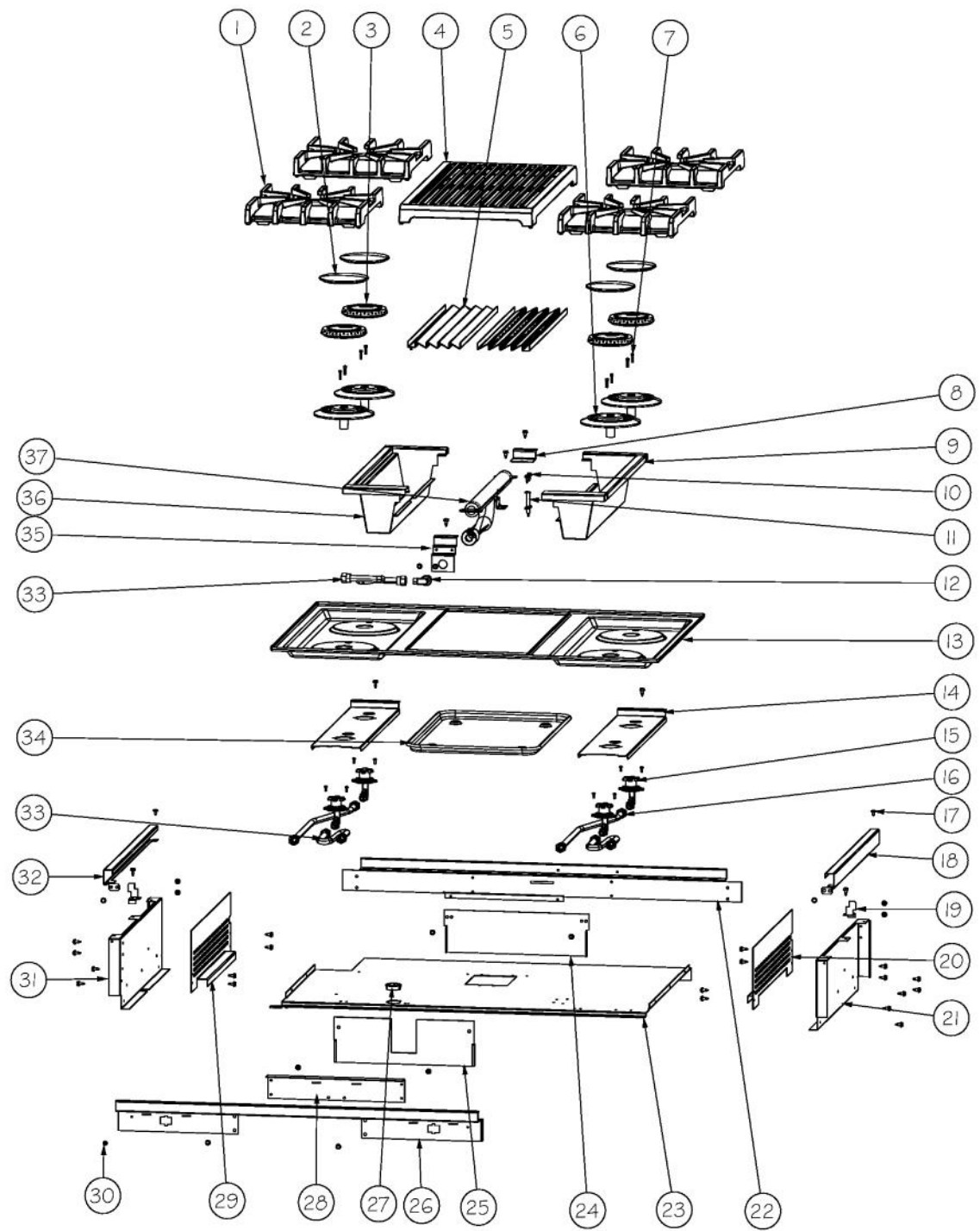

Ref #	Part Number	Qty.	Description
1	007323-000	3	BURNER GRATE
2	PA080083	4	D BURNER CAP XMATTE BLACKX
3	006706-000	4	B6 REV SEALED BURNER
4	010168-000	1	CUSTOM RANGE GRILL GRATE
5	E9101130	2	GRILL SMOKE GENERATOR
6	003322-040	4	SEALED BURNER BASE, TURNED FINISH
7	009197-000	8	NO.6-32 X 5/8 18-8 SS NC SOC CAP
8	008636-000	1	BRACKET, BURNER, GRILL, REAR
9	013593-000	1	PAN, DRIP, ASM, RIGHT
10	003860-000	40	NO.10-18 X .500 FASTNR,SCR,HXWH,STL,ZPLT
11	PA020028	1	SPARK IGNITER
12	PB040238	1	90 DEGREE ORIFICE FITTING, NAT NO.47
13	E9108438BK	1	MAIN TOP (VGRT4G/Q) XBKX
14	002923-000	1	BURNER MODULE SUPPORT
15	001394-000	3	15000 BTU NAT JETHOLDER
15	001394-046	3	12.5 K BTU LP JETHOLDER
16	PB020193	2	16 FLEX TUBING W/CONNECTORS
17	PD020032	4	SRW-8(A)X3/8PH.WFR HD 7/16DIAXNICL
18	002920-000	1	SIDE TRIM, RH - STAINLESS
19	004021-000	2	SUPPORT,TRIM,SIDE
20	016793-000	1	SHIELD, HEAT, RH, Q MODELS
21	002755-000	1	BURNER BOX SIDE, RH
22	004602-000	1	REAR SUPPORT, BURNER BOX 36
23	014116-000	1	BURNER BOX, BTM, VDSC536T (BEFORE 1/26/11)
23	024659-000	1	BURNER,BOX,BOT,VDSC536T (ON OR AFTER 1/26/11)
24	016794-000	1	SHIELD, HEAT, REAR, Q MODELS
25	016796-000	1	SHIELD, HEAT, FR, Q MODELS
26	004603-000	1	FRONT SUPPORT, BURNER BOX 36
27	PD040152	1	SNAP BUSHING
28	012771-000	1	RANGETOP, BRKT, FR, VDSC CUSTOM
29	016792-000	1	SHIELD, HEAT, LH, Q MODELS
30	PD020010	1	10 X 3/8 GREEN GROUNDING SCREW
31	003481-000	1	BURNER BOX SIDE, LH
32	003649-000	1	SIDE TRIM, LH - STAINLESS
33	PB020192	2	10 FLEX TUBING W/CONNECTORS
34	PB080061	1	GREASE PAN
35	007776-000	1	MOUNT, GRILL, BURNER, FRONT
36	013595-000	1	PAN, DRIP, ASM, LEFT
37	007878-000	1	BURNER, GRIL, ASM

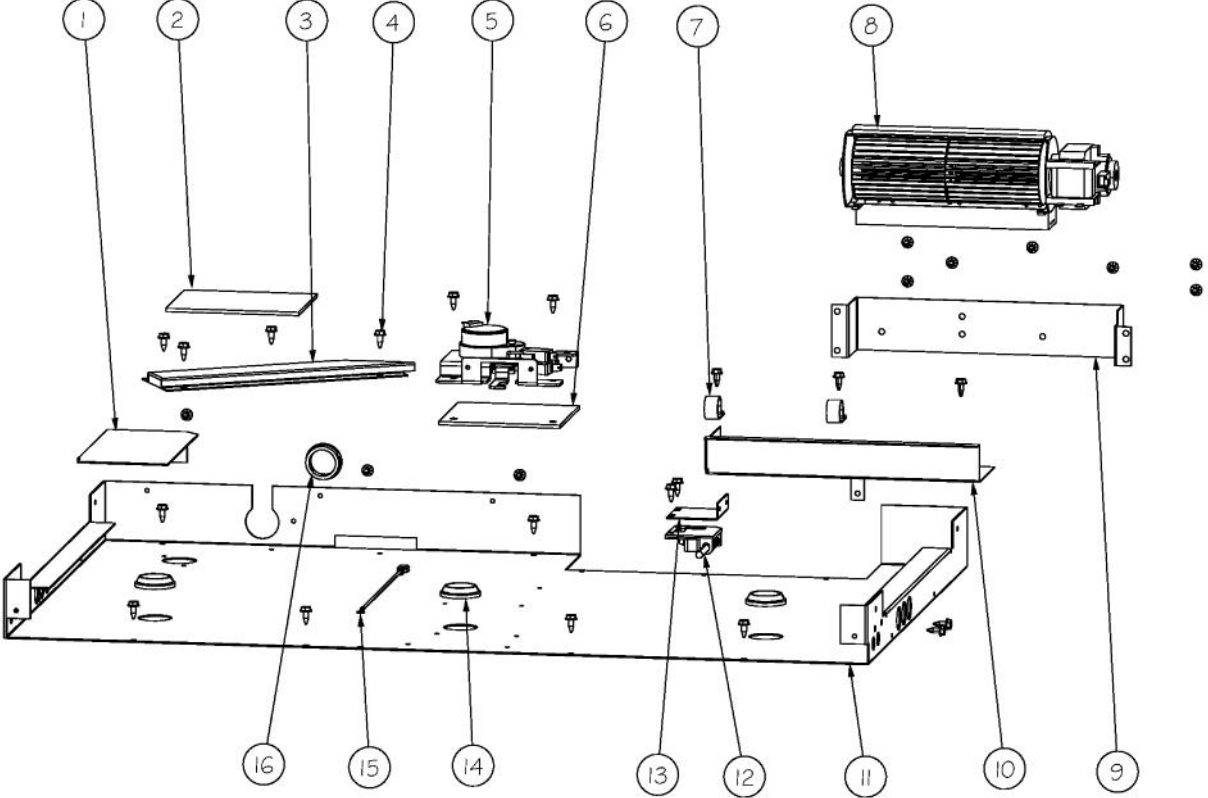

Ref #	Part Number	Qty.	Description
1	004016-000	1	PLATE,SVCE,RGLT
2	004285-000	1	INSULATION, FOIL-BACKED,4X5
3	004698-000	1	FLUE DUCT, VDSC36
4	003860-000	29	NO.10-18 X .500 FASTNR,SCR,HXWH,STL,ZPLT
5	013250-000	1	LATCH,DOOR,ASM,240V,GRIDDLE LOCKOUT
6	013564-000	1	LOWER LATCH INSULATION
7	PD030109	2	INSULATED CLAMP
8	PE050250	1	PREMIUM BLOWER WITH HES (BEFORE 8/10/2013)
8	018607-000	1	FAN,BLO, 220-240V 50/60HZ ASSY (ON OR AFTER 8/10/2013)
9	004110-000	1	MOUNT,BLOWER
10	A2009659	1	BRACKET, FILLER, BLOWER
11	004547-000	1	RANGE TOP BRACE, AIR CHANNEL, 36
12	PE050208	1	DOOR SWITCH
13	A20012649	1	DOOR SWITCH BRACKET
14	PB070079	3	SILICONE EXTRUSION (DGSU)
15	G4000936	1	GROUND WIRE
16	PD040152	1	SNAP BUSHING

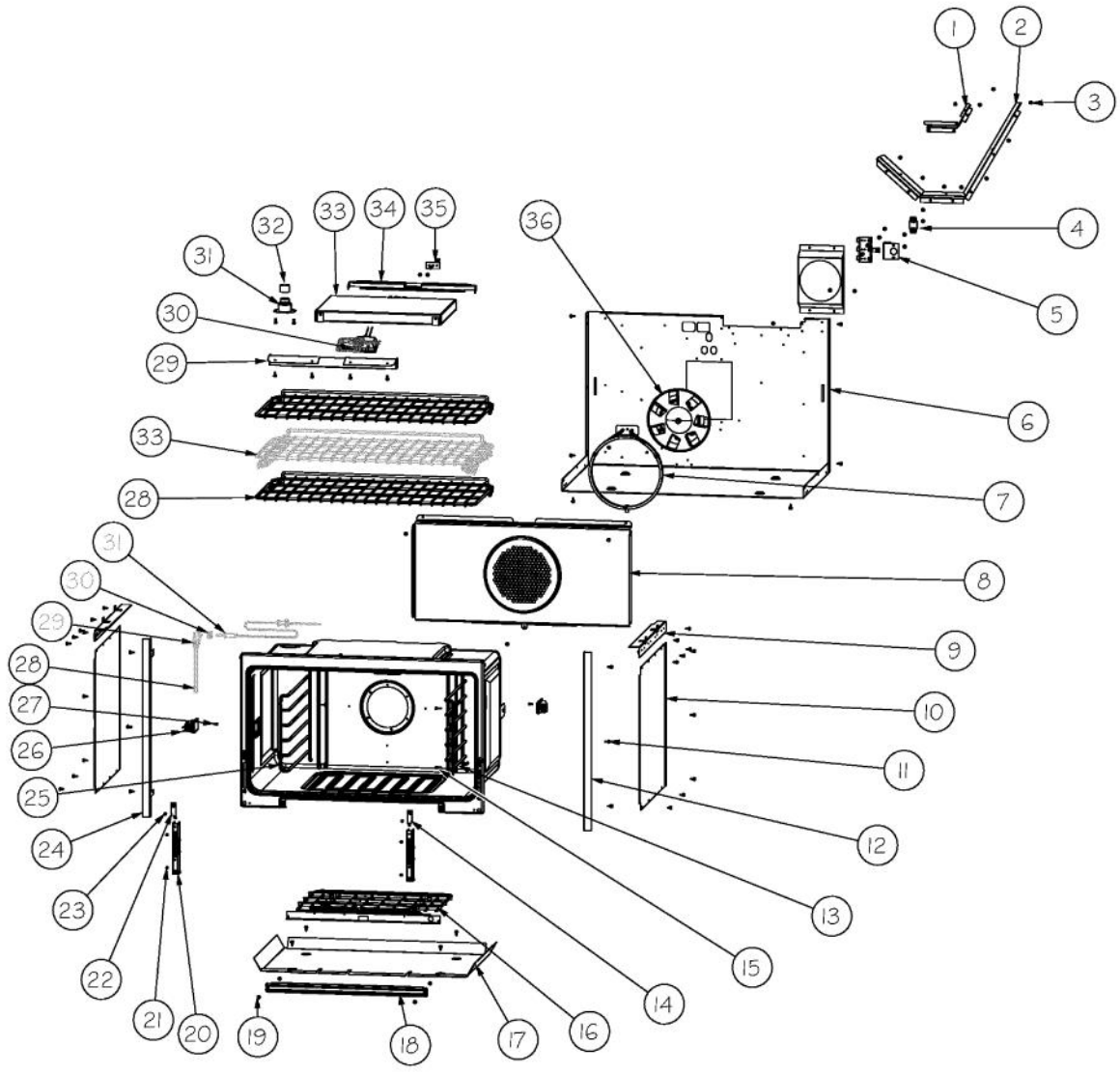

Ref #	Part Number	Qty.	Description
1	003356-000	1	DIVERTER, AIR
2	002941-000	1	BAFFLE, FAN, REAR
3	003860-000	51	NO.10-18 X .500 FASTNR,SCR,HXWH,STL,ZPLT
4	A1002457	1	POWER CORD MOUNTING STRAP (VDSC)
5	A2002195	1	POWER CORD MOUNTING BRKT (VDSC)
6	004542-000	1	OVEN BOTTOM BACK WRAP, 36
7	PJ010047	1	CONVECTION ELEMENT
8	006177-000	1	BAFFLE, CNVN, ASM, VDSC 36
9	A2009641	1	BRKT, TOP WRAPPER
10	014137-000	2	WRAPPER, OVEN SIDE
11	PD020048	13	NO.10 X 1/2 TEK 410 SS SCREW
12	004606-000	1	OVEN, TRIM, FR, SIDE, RH, 36
13	003039-000	1	RACK GUIDE ASSY, RH
14	B21010915	1	HINGE CLIP ? RH
15	PD020232	4	NO.8 X 3/4 PH PAN HEAD TEK SCREW (BLACK OXIDE)
16	PJ010048	1	BAKE ELEMENT
17	004541-000	1	ELEMENT, MTG TRAY 36
18	E9109655	1	BAKE TRAY COVER
19	PD020063	2	SCREW-NO.8(A) X 3/8PH WFR HD/BK OXID
20	031679-000	2	RECEPTACLE, HINGE
21	PD020062	4	NO.8-32 X 3/8 PHMS TYPE 1
22	B21010916	1	HINGE CLIP ? LH
23	PD020061	2	NO.8 X 3/4 FLAT HD TEK. SS.
24	004607-000	1	OVEN, TRIM, FR, SIDE, LH, 36
25	003040-000	1	RACK GUIDE ASSY, LH
26	005311-000	2	120V/25W HALOGEN LIGHT
27	PD020067	2	NO.6 X 3/8 PAN PHIL. TEK SS
28	005953-000	2	OVEN, RACK, ASM, STANDARD, VDSC36
29	B20014050	1	PREMIERE BROIL ELEMENT BRACKET FRONT
30	020403-000	1	BJB SLIMLINE 40W BULB
31	PM010014	1	SMOKE ELIMINATOR (VDSC)
32	PB020275	1	VENT TUBE
33	PJ010050	1	SEALED BROIL ELEMENT W/GLASS
34	B20014051	1	PREMIERE BROIL ELEMENT BRACKET REAR
35	PE050206	1	RTD THERMOSTAT PROBE
36	G32014020	1	CONVECTION FAN ASSY

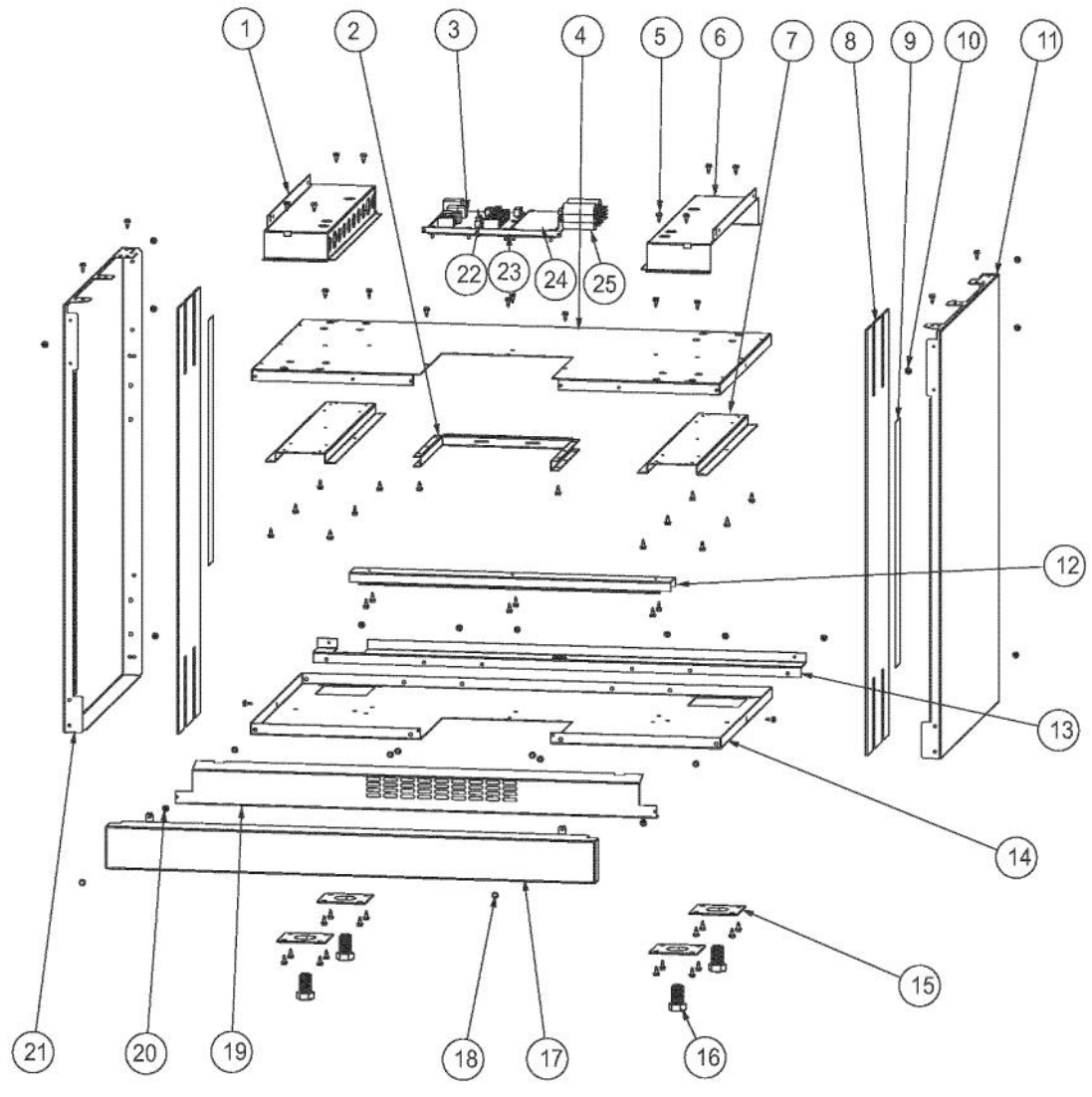

Ref #	Part Number	Qty.	Description
1	003763-000	1	OVEN MODULE SUPPORT CHANNEL, LH
2	003054-000	1	BASE CENTER CUTOOUT STIFFENER
3	014000-000	1	EOC4-CONTROL BOARD
3	038419-000	1	CONTROL,BD,EOC4, CB AFTER 2/4/13
NI	024909-000	1	SHIELD, WRG
4	003328-000	1	PLATE, BASE, UPR, 36
5	003860-000	76	NO.10-18 X .500 FASTNR,SCR,HXWH,STL,ZPLT
6	003761-000	1	OVEN MODULE SUPPORT CHANNEL, RH
7	003053-000	2	BASE LEG SUPPORT CHANNEL
8	007488-000	2	SINK, REAR, SIDE
9	M0275166	2	TAPE-ALUM SL
10	014143-000	2	SCR 10-12 A SHLD TRP 1/2 S ZN BLUE
11	002905-000	1	SIDE PANEL, RH, SST
12	003327-000	1	BRACE, BASE, 36
13	004503-000	1	BASE, LEDG, BACK, 36
14	003326-000	1	PLATE, BASE, LWR, 36
15	PC030007	4	LEG PLATE - 3/4 THREADED HOLE
16	PD010022	4	HEX HD. BOLT - 3/4-10 X 1-1/4
17	005382-000	1	KICKPLATE, SS, VDSC36
18	PD020032	1	SRW-8(A)X3/8PH.WFR HD 7/16DIAXNICL
19	005381-000	1	ACCESS GRILL PANEL, LOWER 36
20	003801-000	2	SHOULDER SCREW, NO.10
21	003588-000	1	SIDE PANEL, LH
22	PE070763	1	10 POSITION 30 L.O.
23	015096-000	1	PLATE, MTG, EOC4 CONTROL BOARD
24	013999-000	1	SWITCHING POWER SUPPLY BOARD / EOC4
25	PE050247		EBM FAN MOTOR CAPACITOR
	PD030172	2	M8 X 1.25MM NUT (USED TO INSTALL CAPACITOR)
NI	PD040164	2	5/16 INTERNAL TOOTH LOCK WASHER TYPE A (USED TO INSTALL CAPACITOR)
NI	PD020043	13	NO.6-32 X .750 PH. CTRSK T(F)-VGSO166 (USED TO INSTALL BOARDS)

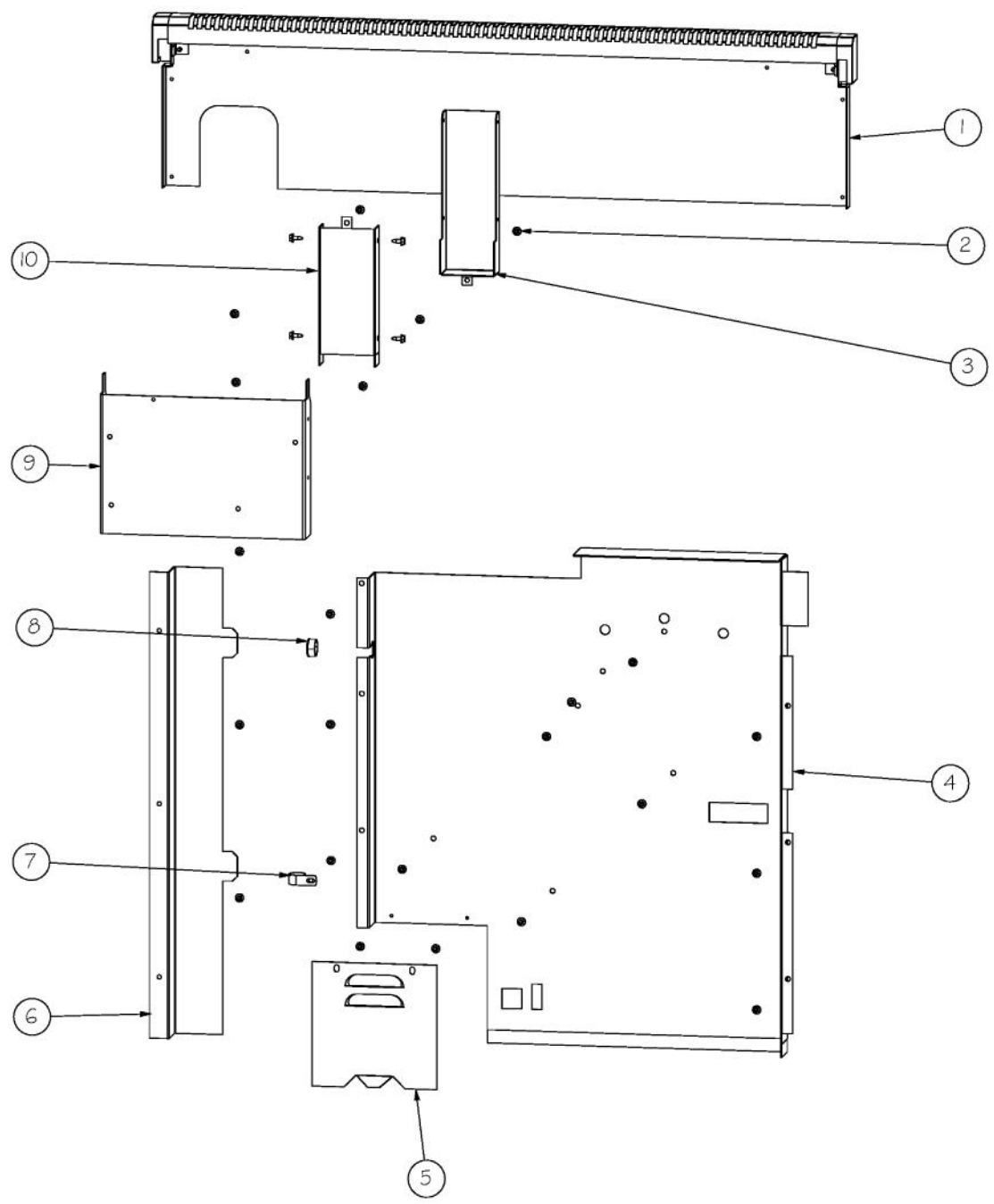

Ref #	Part Number	Qty.	Description
1	006900-000	1	ISLAND TRIM, ASM, 36 CUSTOM
2	003860-000	27	NO.10-18 X .500 FASTNR,SCR,HXWH,STL,ZPLT
3	A20010101	1	FLUE, OUTSIDE SHELL
4	003272-000	1	COVER, REAR
5	A2002454	1	BACK COVER ACCESS DOOR
6	003245-000	1	CHANNEL, WIRE, REAR
7	PD030109	1	INSULATED CLAMP
8	PD040005	1	SNAP BUSHING - 7/8
9	003681-000	1	DUCT, AIR
10	A20010102	1	FLUE, CENTER EXTENDED

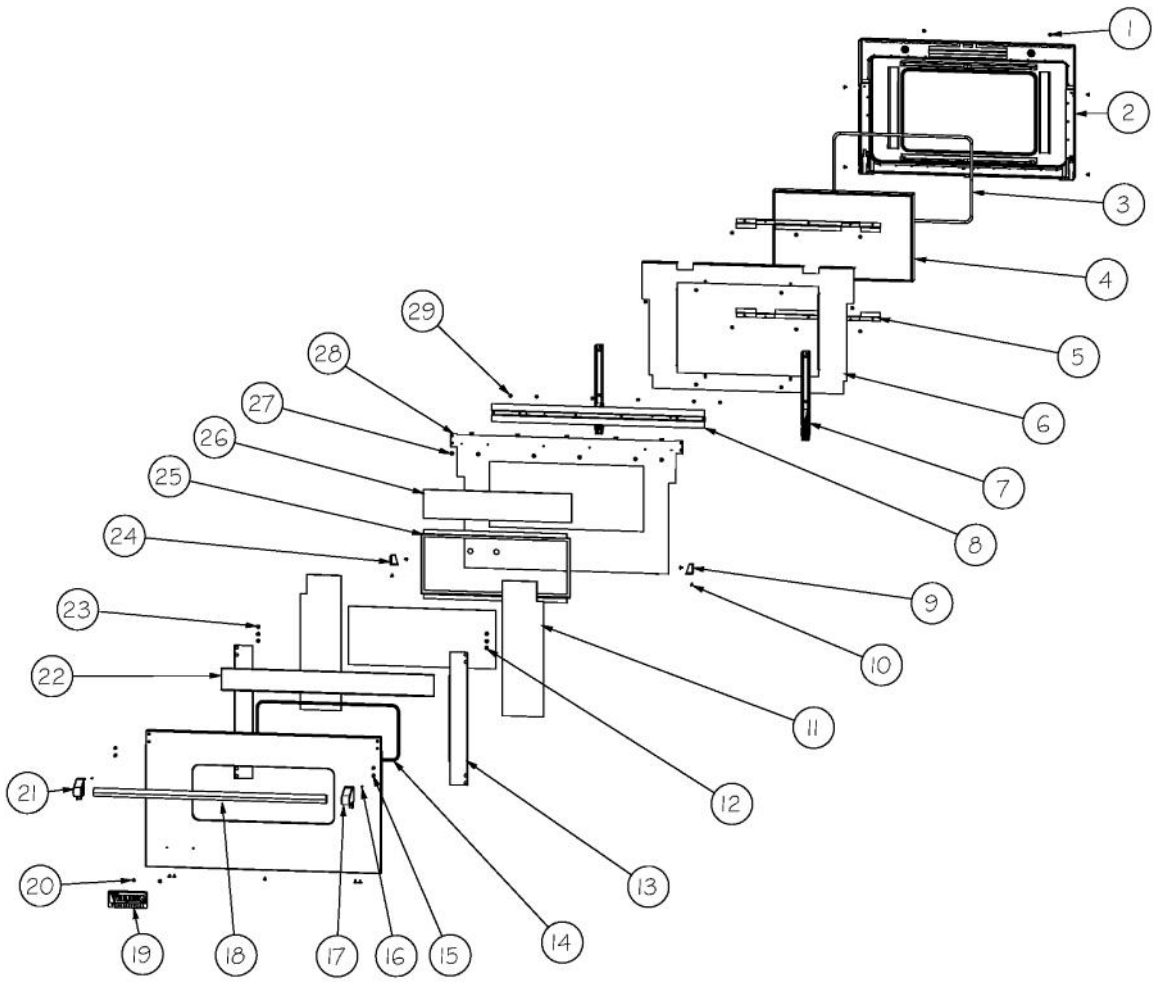

Ref #	Part Number	Qty.	Description
1	PD020063	20	SCREW-NO.8(A) X 3/8PH WFR HD/BK OXID
2	002713-402	1	LINER,DOOR ,WLD,ASSY 36 BK
3	000594-000	1	BLACK FIBERGLASS ROPE 3/8
4	PE060094	1	30 WINDOW PACK
5	004153-000	2	DOOR GLASS HOLDER BRACKET
6	006076-000	1	DOOR LINER INSULATION RETAINER, 36
7	013290-000	2	HINGE, DOOR, VGCC36 - PINK SPRING
8	006089-000	1	DOOR SKIN MTG BRACKET ASSY, 36
9	006807-000	1	HINGE, BRKT, RH
10	PD020032	7	SRW-8(A)X3/8PH.WFR HD 7/16DIAXNCL
11	006086-000	2	DOOR, SKIN, INSULATION, SIDE, 36
12	PD020073	2	SRW NO.10 X 24 X 3/8 WAFER HD TYPE23
13	002726-000	2	DOOR SKIN SIDE BRACKET
14	PE060105	1	30 J-MOLD (CHROME) NOT FIELD REPLACEABLE
15	002736-000	3	NO.10-32 PAN HEAD PHILLIPS MACHINE SCREW
16	003650-000	2	SET SCREW
17	003012-000	1	DOOR HANDLE ENDCAP ASSY, RH (CHROME)
17	003012-100	1	DOOR HANDLE ENDCAP ASSY, RH (BRASS)
18	006080-000	1	36 DOOR HANDLE, SST
19	PE010030	1	LOGO, 6, PRO, BK
19	PE010079	1	4.5 LOGO/VIKING PROF, BK/BR
20	PD030006	2	CAPPED WASHER PAL NUT
21	003011-000	1	DOOR HANDLE ENDCAP ASSY, LH (CHROME)
21	003011-100	1	DOOR HANDLE ENDCAP ASSY, LH (BRASS)
22	006082-000	1	DOOR SKIN HEAT SINK, 36
23	004907-000	4	STEEL FINISHING PLUG, NICKEL PLTD 25/64 HOLE
24	006808-000	1	HINGE, BRKT, LH
25	L20014077	1	30 WINDOW HOLDER NOT FIELD REPLACEABLE
26	006788-000	1	INSULATION,DOOR,TOP,SUPERWOOL,,25,VDSC530
27	PD020033	6	SRW-NO.10-24X1/2T(23)PH.WFR HD (NKL)
28	006084-000	1	DOOR SKIN INSULATION RETAINER, 36
29	PD030010	6	NO.10-24 KEPS NUT
NI	021311-000	1	DOOR SKIN SERVICE ASSEMBLY, SS
NI	021312-002	1	DOOR SKIN SERVICE ASSEMBLY, BK
NI	021312-003	1	DOOR SKIN SERVICE ASSEMBLY, BT
NI	021312-004	1	DOOR SKIN SERVICE ASSEMBLY, SG
NI	021312-005	1	DOOR SKIN SERVICE ASSEMBLY, GG
NI	021312-006	1	DOOR SKIN SERVICE ASSEMBLY, WH
NI	021312-008	1	DOOR SKIN SERVICE ASSEMBLY, BU
NI	021312-009	1	DOOR SKIN SERVICE ASSEMBLY, LE
NI	021312-010	1	DOOR SKIN SERVICE ASSEMBLY, MJ
NI	021312-012	1	DOOR SKIN SERVICE ASSEMBLY, VB
NI	021312-013	1	DOOR SKIN SERVICE ASSEMBLY, CB
NI	021312-015	1	DOOR SKIN SERVICE ASSEMBLY, PL
NI	021312-016	1	DOOR SKIN SERVICE ASSEMBLY, CH
NI	021312-017	1	DOOR SKIN SERVICE ASSEMBLY, TP
NI	021312-018	1	DOOR SKIN SERVICE ASSEMBLY, CW
NI	021312-019	1	DOOR SKIN SERVICE ASSEMBLY, OG
NI	021312-020	1	DOOR SKIN SERVICE ASSEMBLY, GM
NI	021312-021	1	DOOR SKIN SERVICE ASSEMBLY, SA
NI	021312-022	1	DOOR SKIN SERVICE ASSEMBLY, SE
NI	021312-023	1	DOOR SKIN SERVICE ASSEMBLY, IB
NI	021312-024	1	DOOR SKIN SERVICE ASSEMBLY, AR
NI	021312-025	1	DOOR SKIN SERVICE ASSEMBLY, RR
NI	021312-026	1	DOOR SKIN SERVICE ASSEMBLY, PM
NI	021312-027	1	DOOR SKIN SERVICE ASSEMBLY, MS
NI	006100-000	1	DOOR ASSEMBLY, 36 - SS
NI	009915-002	1	DOOR ASSEMBLY, 36 - BK
NI	009915-003	1	DOOR ASSEMBLY, 36 - BT
NI	009915-004	1	DOOR ASSEMBLY, 36 - SG

Ref #	Part Number	Qty.	Description
NI	009915-004	1	DOOR ASSEMBLY, 36 - SG
NI	009915-005	1	DOOR ASSEMBLY, 36 - GG
NI	009915-006	1	DOOR ASSEMBLY, 36 - WH
NI	009915-008	1	DOOR ASSEMBLY, 36 - BU
NI	009915-009	1	DOOR ASSEMBLY, 36 - LE
NI	009915-010	1	DOOR ASSEMBLY, 36 - MJ
NI	009915-012	1	DOOR ASSEMBLY, 36 - VB
NI	009915-013	1	DOOR ASSEMBLY, 36 - CB
NI	009915-015	1	DOOR ASSEMBLY, 36 - PL
NI	009915-016	1	DOOR ASSEMBLY, 36 - CH
NI	009915-017	1	DOOR ASSEMBLY, 36 - TP
NI	009915-018	1	DOOR ASSEMBLY, 36 - CW
NI	009915-019	1	DOOR ASSEMBLY, 36 - OG
NI	009915-020	1	DOOR ASSEMBLY, 36 - GM
NI	009915-021	1	DOOR ASSEMBLY, 36 - SA
NI	009915-022	1	DOOR ASSEMBLY, 36 - SE
NI	009915-023	1	DOOR ASSEMBLY, 36 - IB
NI	009915-024	1	DOOR ASSEMBLY, 36 - AR
NI	009915-025	1	DOOR ASSEMBLY, 36 - RR
NI	009915-026	1	DOOR ASSEMBLY, 36 - PM
NI	009915-027	1	DOOR ASSEMBLY, 36 - MS
NI	006100-100	1	DOOR ASSEMBLY - SS/BR, 36
NI	009915-102	1	DOOR ASSEMBLY, 36 - BK/BR
NI	009915-103	1	DOOR ASSEMBLY, 36 - BT/BR
NI	009915-104	1	DOOR ASSEMBLY, 36 - SG/BR
NI	009915-105	1	DOOR ASSEMBLY, 36 - GG/BR
NI	009915-106	1	DOOR ASSEMBLY, 36 - WH/BR
NI	009915-108	1	DOOR ASSEMBLY, 36 - BU/BR
NI	009915-109	1	DOOR ASSEMBLY, 36 - LE/BR
NI	009915-110	1	DOOR ASSEMBLY, 36 - MJ/BR
NI	009915-112	1	DOOR ASSEMBLY, 36 - VB/BR
NI	009915-113	1	DOOR ASSEMBLY, 36 - CB/BR
NI	009915-115	1	DOOR ASSEMBLY, 36 - PL/BR
NI	009915-116	1	DOOR ASSEMBLY, 36 - CH/BR
NI	009915-117	1	DOOR ASSEMBLY, 36 - TP/BR
NI	009915-118	1	DOOR ASSEMBLY, 36 - CW/BR
NI	009915-119	1	DOOR ASSEMBLY, 36 - OG/BR
NI	009915-120	1	DOOR ASSEMBLY, 36 - GM/BR
NI	009915-121	1	DOOR ASSEMBLY, 36 - SA/BR
NI	009915-122	1	DOOR ASSEMBLY, 36 - SE/BR
NI	009915-123	1	DOOR ASSEMBLY, 36 - IB/BR
NI	009915-124	1	DOOR ASSEMBLY, 36 - AR/BR
NI	009915-125	1	DOOR ASSEMBLY, 36 - RR/BR
NI	009915-126	1	DOOR ASSEMBLY, 36 - PM/BR
NI	009915-127	1	DOOR ASSEMBLY, 36 - MS/BR
NI	006996-000	1	DOOR GASKET, 36

*No Image
Available*

Ref #	Part Number	Qty.	Description
NI	024909-000	1	SHIELD, WRG
NI	015103-000	1	HARNESS,TEST,VDSC-T MODELS
NI	PE070735	1	MEAT PROBE HARNESS
NI	015100-000	1	HARNESS,WIRING,VDSC530-T
NI	015103-000	1	HARNESS,TEST,VDSC-T MODELS
NI	G4000936	1	GROUND WIRE
NI	PE070739	1	BAKE ELEMENT HARNESS
NI	000647-000	2	IRIS IGNITOR WIRE, FRONT BURNER
NI	001134-000	2	IRIS HARNESS INSULATED CAP
NI	006766-000	3	IRIS IGNITOR WIRE, BACK BURNER
NI	PE070643	2	SPARK IGNITOR WIRE - 30KVDC
NI	PE070890	1	IRIS HARNESS - 36
NI	007378-000	1	LIGHT SWITCH HARNESS
NI	003245-000	1	CHANNEL, WIRE, REAR