

This Owner's Manual is provided and hosted by [Appliance Factory Parts](#).



VIKING VDSC536T-6B Owner's Manual

[Shop genuine replacement parts for VIKING
VDSC536T-6B](#)



[Find Your VIKING Range Hoods Parts - Select From 411 Models](#)

----- Manual continues below -----

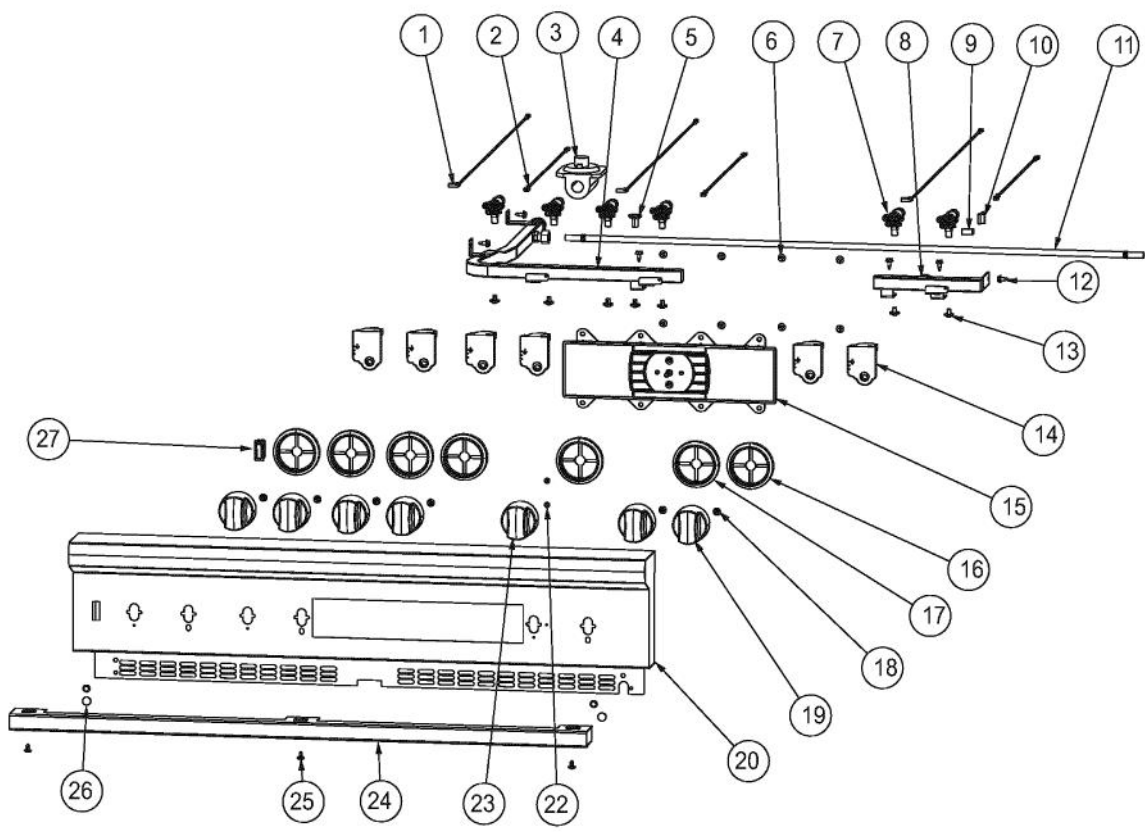

Ref #	Part Number	Qty.	Description
1	006766-000	3	IRIS IGNITOR WIRE, BACK BURNER
2	000647-000	3	IRIS IGNITOR WIRE, FRONT BURNER
3	PA070001	1	PRESSURE REGULATOR (NAT.)
3	00714-000	1	PRESSURE REGULATOR (LP)
4	019163-000	1	MANIFOLD ASM, LH
5	002884-000	1	MANIFOLD PLUG
6	PD010003	8	10-24 X 1/2 PH.TR.HD.SERD.M.S.
7	006015-000	5	VALVE, BRS, SEALED TOP - ISPHORDING
8	019190-000	1	MANIFOLD ASM
9	001134-000	1	IRIS HARNESS INSULATED CAP
10	PE070889	1	IRIS HARNESS - 30
11	PB020112	1	3/8 SS FLEX TUBING - 36 T6-36
12	003860-000	5	NO.10-18 X .500 FASTNR,SCR,HXWH,STL,ZPLT
13	PD010012	7	VALVE BOLT 1/4-20 UNC-2B 5/16 M.S.
14	PA020058	6	IRIS SINGLE SPARK MODULE
15	013995-000	1	VDSC ELECTRONIC CONTROLS MODULE
16	PB010304	5	KNOB BEZEL
16	PB010304PVD	5	RESTYLE KNOB BEZEL, BR
17	010348-000	2	KNOB BEZEL,VDSC, ELECTRONIC CONTROLS, SS
17	010348-100	2	KNOB BEZEL,VDSC, ELEC CONTROLS (BR)
18	PD020046	6	NO.8 X 1/2 SCREWS
19	005269-000	5	RANGE TOP BURNER KNOB-BRUSHED, SSS
20	019254-000	1	PANEL,CTRL,FNSH,W/GRAPH,VDSC536T-6B
21	PD020062	2	NO.8-32 X 3/8 PHMS TYPE 1
22	013950-000	1	OVEN KNOB, VDSC ELECTRONIC CONTROLS
23	011637-000	1	TRIM, ASM
24	PD020032	5	SRW-8(A)X3/8PH.WFR HD 7/16DIAXNICL
25	PD040004	2	GROMMET BUMPER
26	003719-000	1	OVEN LIGHT SWITCH, BLACK

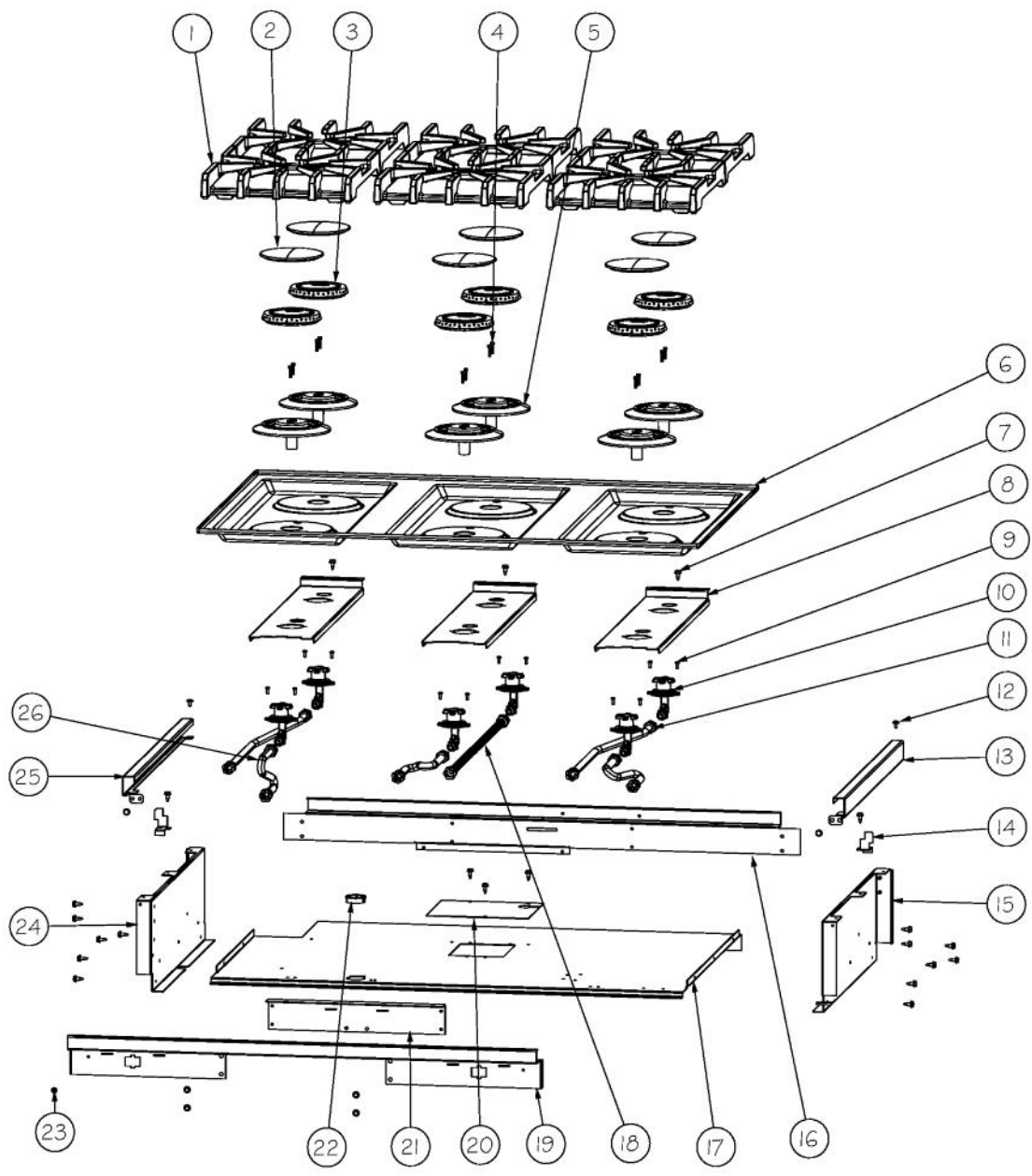

Ref #	Part Number	Qty.	Description
1	007323-000	6	BURNER GRATE
2	PA080083	5	D BURNER CAP XMATTE BLACKX
3	006706-000	6	B6 REV SEALED BURNER
4	009197-000	12	NO.6-32 X 5/8 18-8 SS NC SOC CAP
5	003322-041	6	SEALED BURNER BASE, PAINTED FINISH
6	E9108439BK	1	MAIN TOP (VGRT3626B) XBKX
7	003860-000	25	NO.10-18 X .500 FASTNR,SCR,HXWH,STL,ZPLT
8	002923-000	3	BURNER MODULE SUPPORT
9	PD020076	12	6-32 X 3/8 PHILL PAN MS
10	001394-042	6	15000 BTU NAT JETHOLDER
10	001394-046	6	12.5 K BTU LP JETHOLDER
11	PB020193	2	16 FLEX TUBING W/CONNECTORS
12	PD020032	4	SRW-8(A)X3/8PH.WFR HD 7/16DIAXNICL
13	002920-000	1	SIDE TRIM, RH - STAINLESS
14	004021-000	2	SUPPOT,TRIM,SIDE
15	002755-000	1	BURNER BOX SIDE, RH
16	004602-000	1	REAR SUPPORT, BURNER BOX 36
17	014116-000	1	BURNER BOX, BTM, VDSC536T (BEFORE 1/26/11)
17	024659-000	1	BURNER,BOX,BOT,VDSC536T (ON OR AFTER 1/26/11)
18	007726-000	1	21 FLEX TUBING W/CONNECTORS
19	004603-000	1	FRONT SUPPORT, BURNER BOX 36
20	008904-000	1	BURNER BOX, DSI COVER (BEFORE 1/26/11)
20	024398-000	1	COVER,ACS,DSI (ON OR AFTER 1/26/11)
21	012771-000	1	RANGETOP, BRKT, FR, VDSC CUSTOM
22	PD040152	1	SNAP BUSHING
23	PD020010	1	10 X 3/8 GREEN GROUNDING SCREW
24	003481-000	1	BURNER BOX SIDE, LH
25	003649-000	1	SIDE TRIM, LH - STAINLESS
26	PB020192	3	10 FLEX TUBING W/CONNECTORS

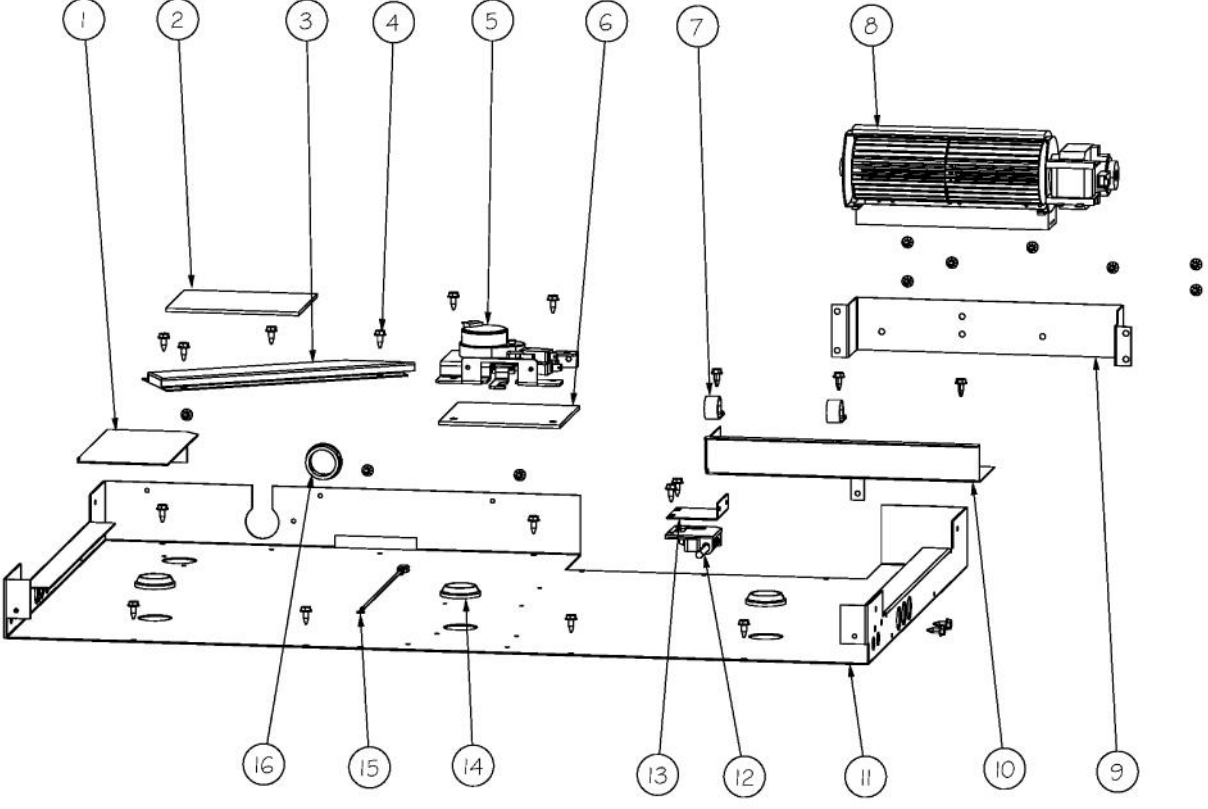

Ref #	Part Number	Qty.	Description
1	004016-000	1	PLATE,SVCE,RGLT
2	004285-000	1	INSULATION, FOIL-BACKED,4X5
3	004698-000	1	FLUE DUCT, VDSC36
4	003860-000	29	NO.10-18 X .500 FASTNR,SCR,HXWH,STL,ZPLT
5	013250-000	1	LATCH,DOOR,ASM,240V,GRIDDLE LOCKOUT
6	013564-000	1	LOWER LATCH INSULATION
7	PD030109	2	INSULATED CLAMP
8	PE050250	1	PREMIUM BLOWER WITH HES (BEFORE 8/10/2013)
8	018607-000	1	FAN,BLO, 220-240V 50/60HZ ASSY (ON OR AFTER 8/10/2013)
9	004110-000	1	MOUNT,BLOWER
10	A2009659	1	BRACKET, FILLER, BLOWER
11	004547-000	1	RANGE TOP BRACE, AIR CHANNEL, 36
12	PE050208	1	DOOR SWITCH
13	A20012649	1	DOOR SWITCH BRACKET
14	PB070079	3	SILICONE EXTRUSION (DGSU)
15	G4000936	1	GROUND WIRE
16	PD040152	1	SNAP BUSHING

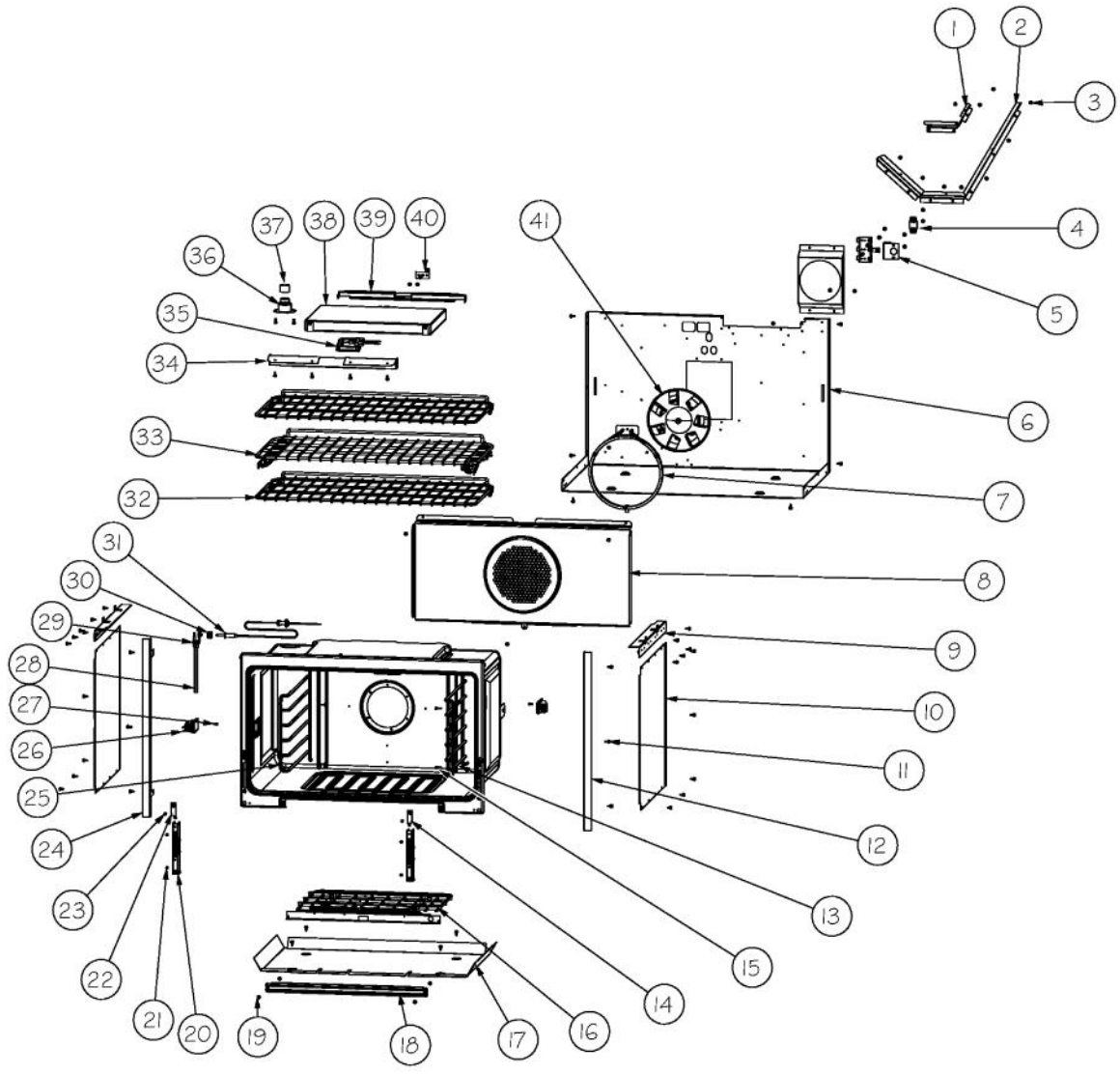

Ref #	Part Number	Qty.	Description
1	003356-000	1	DIVERTER, AIR
2	002941-000	1	BAFFLE, FAN, REAR
3	003860-000	51	NO.10-18 X .500 FASTNR,SCR,HXWH,STL,ZPLT
4	A1002457	1	POWER CORD MOUNTING STRAP (VDSC)
5	A2002195	1	POWER CORD MOUNTING BRKT (VDSC)
6	004542-000	1	OVEN BOTTOM BACK WRAP, 36
7	PJ010047	1	CONVECTION ELEMENT
8	006177-000	1	BAFFLE, CNVN, ASM, VDSC 36
9	A2009641	1	BRKT, TOP WRAPPER
10	014137-000	2	WRAPPER, OVEN SIDE
11	PD020048	13	NO.10 X 1/2 TEK 410 SS SCREW
12	004606-000	1	OVEN, TRIM, FR, SIDE, RH, 36
13	003039-000	1	RACK GUIDE ASSY, RH
14	B21010915	1	HINGE CLIP ? RH
15	PD020232	4	NO.8 X 3/4 PH PAN HEAD TEK SCREW (BLACK OXIDE)
16	PJ010048	1	BAKE ELEMENT
17	004541-000	1	ELEMENT, MTG TRAY 36
18	E9109655	1	BAKE TRAY COVER
19	PD020063	2	SCREW-NO.8(A) X 3/8PH WFR HD/BK OXID
20	031679-000	2	RECEPTACLE, HINGE
21	PD020062	4	NO.8-32 X 3/8 PHMS TYPE 1
22	B21010916	1	HINGE CLIP ? LH
23	PD020061	2	NO.8 X 3/4 FLAT HD TEK. SS.
24	004607-000	1	OVEN, TRIM, FR, SIDE, LH, 36
25	003040-000	1	RACK GUIDE ASSY, LH
26	005311-000	2	120V/25W HALOGEN LIGHT
27	PD020067	2	NO.6 X 3/8 PAN PHIL. TEK SS
28	PE070735	1	MEAT PROBE HARNESS
29	PE050115	1	MEAT PROBE JACK
30	PM010160	1	MEAT PROBE JACK COVER
31	PE050114	1	MEAT PROBE (DESO/DEDO) (SWITCHCRAFT'S PART NO. 4...
32	005953-000	2	OVEN, RACK, ASM, STANDARD, VDSC36
33	007000-000	1	36 TRU-GLIDE RACK
34	B20014050	1	PREMIERE BROIL ELEMENT BRACKET FRONT
35	005312-000	1	BJB SLIMLINE 40 W BULB
36	PM010014	1	SMOKE ELIMINATOR (VDSC)
37	PB020275	1	VENT TUBE
38	PJ010050	1	SEALED BROIL ELEMENT W/GLASS
39	B20014051	1	PREMIERE BROIL ELEMENT BRACKET REAR
40	PE050206	1	RTD THERMOSTAT PROBE
41	G32014020	1	CONVECTION FAN ASSY

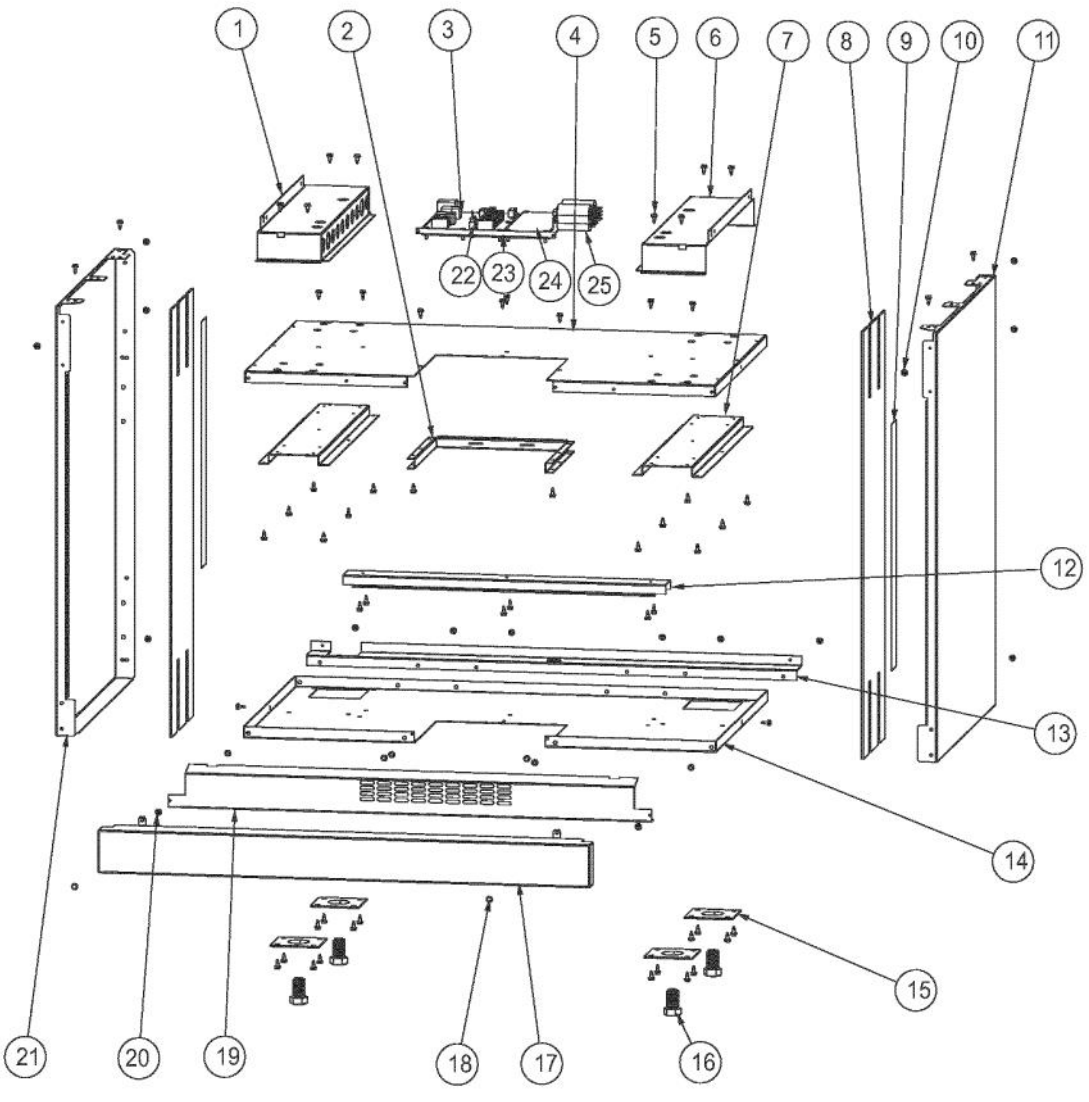

Ref #	Part Number	Qty.	Description
1	003763-000	1	OVEN MODULE SUPPORT CHANNEL, LH
2	003054-000	1	BASE CENTER CUTOOUT STIFFENER
3	014000-000	1	EOC4-CONTROL BOARD
3	038419-000	1	CONTROL,BD,EOC4, CB AFTER 2/4/13
NI	024909-000	1	SHIELD, WRG
4	003328-000	1	PLATE, BASE, UPR, 36
5	003860-000	76	NO.10-18 X .500 FASTNR,SCR,HXWH,STL,ZPLT
6	003761-000	1	OVEN MODULE SUPPORT CHANNEL, RH
7	003053-000	2	BASE LEG SUPPORT CHANNEL
8	007488-000	2	SINK, REAR, SIDE
9	M0275166	2	TAPE-ALUM SL
10	014143-000	2	SCR 10-12 A SHLD TRP 1/2 S ZN BLUE
11	002905-000	1	SIDE PANEL, RH, SST
11	019410-002	1	PANEL, ASM, SIDE, RH-BK
11	019410-003	1	PANEL, ASM, SIDE, RH-BT
11	019410-004	1	PANEL, ASM, SIDE, RH-SG
11	019410-005	1	PANEL, ASM, SIDE, RH-GG
11	019410-006	1	PANEL, ASM, SIDE, RH, WH
11	019410-008	1	PANEL, ASM, SIDE, RH-BU
11	019410-009	1	PANEL, ASM, SIDE, RH-LE
11	019410-010	1	PANEL, ASM, SIDE, RH-MJ
11	019410-012	1	PANEL, ASM, SIDE, RH-VB
11	019410-013	1	PANEL, ASM, SIDE, RH-CB
11	019410-015	1	PANEL, ASM, SIDE, RH-PL
11	019410-016	1	PANEL, ASM, SIDE, RH-CH
11	019410-017	1	PANEL, ASM, SIDE, RH-TP
11	019410-018	1	PANEL, ASM, SIDE, RH-CW
11	019410-019	1	PANEL, ASM, SIDE, RH-OG
11	019410-020	1	PANEL, ASM, SIDE, RH-GM
11	019410-021	1	PANEL, ASM, SIDE, RH-SA
11	019410-022	1	PANEL, ASM, SIDE, RH-SE
11	019410-023	1	PANEL, ASM, SIDE, RH-IB
11	019410-024	1	PANEL, ASM, SIDE, RH-AR
11	019410-025	1	PANEL, ASM, SIDE, RH-RR
11	019410-026	1	PANEL, ASM, SIDE, RH-PM
11	019410-027	1	PANEL, ASM, SIDE, RH-MS
12	003327-000	1	BRACE, BASE, 36
13	004503-000	1	BASE, LEDG, BACK, 36
14	003326-000	1	PLATE, BASE, LWR, 36
15	PC030007	4	LEG PLATE - 3/4 THREADED HOLE
16	PD010022	4	HEX HD. BOLT - 3/4-10 X 1-1/4
17	005382-000	1	KICKPLATE, SS, VDSC36
17	010989-002	1	KICKPLATE, BK
17	010989-003	1	KICKPLATE, BT 36
17	010989-004	1	KICKPLATE, SG 36
17	010989-005	1	KICKPLATE, 36 GG
17	010989-006	1	KICKPLATE, 36 WH
17	010989-008	1	KICKPLATE, BU 36
17	010989-009	1	KICKPLATE, LE 36
17	010989-010	1	KICKPLATE, MJ 36
17	010989-012	1	KICKPLATE, VB 36
17	010989-013	1	KICKPLATE - CB
17	010989-015	1	KICKPLATE, PL 36
17	010989-016	1	KICKPLATE, CH 36
17	010989-017	1	KICKPLATE, TP 36
17	010989-018	1	KICKPLATE, CW 36
17	010989-019	1	KICKPLATE, OG 36
17	010989-020	1	KICKPLATE, GM 36
17	010989-021	1	KICKPLATE, SA 36

Ref #	Part Number	Qty.	Description
17	010989-021	1	KICKPLATE, SA 36
17	010989-022	1	KICKPLATE, SE 36
17	010989-023	1	KICKPLATE, IB 36
17	010989-024	1	KICKPLATE, AR 36
17	010989-025	1	KICKPLATE, RR 36
17	010989-026	1	KICKPLATE, PM 36
17	010989-027	1	KICKPLATE, MS 36
18	PD020032	1	SRW-8(A)X3/8PH.WFR HD 7/16DIAXNCL
19	005381-000	1	ACCESS GRILL PANEL, LOWER 36
20	003801-000	2	SHOULDER SCREW, NO.10
21	003588-000	1	SIDE PANEL, LH
21	019411-002	1	PANEL, ASM, SIDE, LH-BK
21	019411-003	1	PANEL, ASM, SIDE, LH-BT
21	019411-004	1	PANEL, ASM, SIDE, LH-SG
21	019411-005	1	PANEL, ASM, SIDE, LH-GG
21	019411-006	1	PANEL, ASM, SIDE, LH, WH
21	019411-008	1	PANEL, ASM, SIDE, LH-BU
21	019411-009	1	PANEL, ASM, SIDE, LH-LE
21	019411-010	1	PANEL, ASM, SIDE, LH-MJ
21	019411-012	1	PANEL, ASM, SIDE, LH-VB
21	019411-013	1	PANEL, ASM, SIDE, LH-CB
21	019411-015	1	PANEL, ASM, SIDE, LH-PL
21	019411-016	1	PANEL, ASM, SIDE, LH-CH
21	019411-017	1	PANEL, ASM, SIDE, LH-TP
21	019411-018	1	PANEL, ASM, SIDE, LH-CW
21	019411-019	1	PANEL, ASM, SIDE, LH-OG
21	019411-020	1	PANEL, ASM, SIDE, LH-GM
21	019411-021	1	PANEL, ASM, SIDE, LH-SA
21	019411-022	1	PANEL, ASM, SIDE, LH-SE
21	019411-023	1	PANEL, ASM, SIDE, LH-IB
21	019411-024	1	PANEL, ASM, SIDE, LH-AR
21	019411-025	1	PANEL, ASM, SIDE, LH-RR
21	019411-026	1	PANEL, ASM, SIDE, LH-PM
21	019411-027	1	PANEL, ASM, SIDE, LH-MS
22	014000-000	1	EOC4-CONTROL BOARD
23	015096-000	1	PLATE, MTG, EOC4 CONTROL BOARD
24	013999-000	1	SWITCHING POWER SUPPLY BOARD / EOC4
25	PE050247	2	EBM FAN MOTOR CAPACITOR
NI	PD020043	13	NO.6-32 X .750 PH. CTRSK T(F)-VGSO166 (USED TO INSTALL BOARDS)
NI	PD030172	2	M8 X 1.25MM NUT (USED TO INSTALL CAPACITOR)
NI	PD040164	2	5/16 INTERNAL TOOTH LOCK WASHER TYPE A (USED TO INSTALL CAPACITOR)

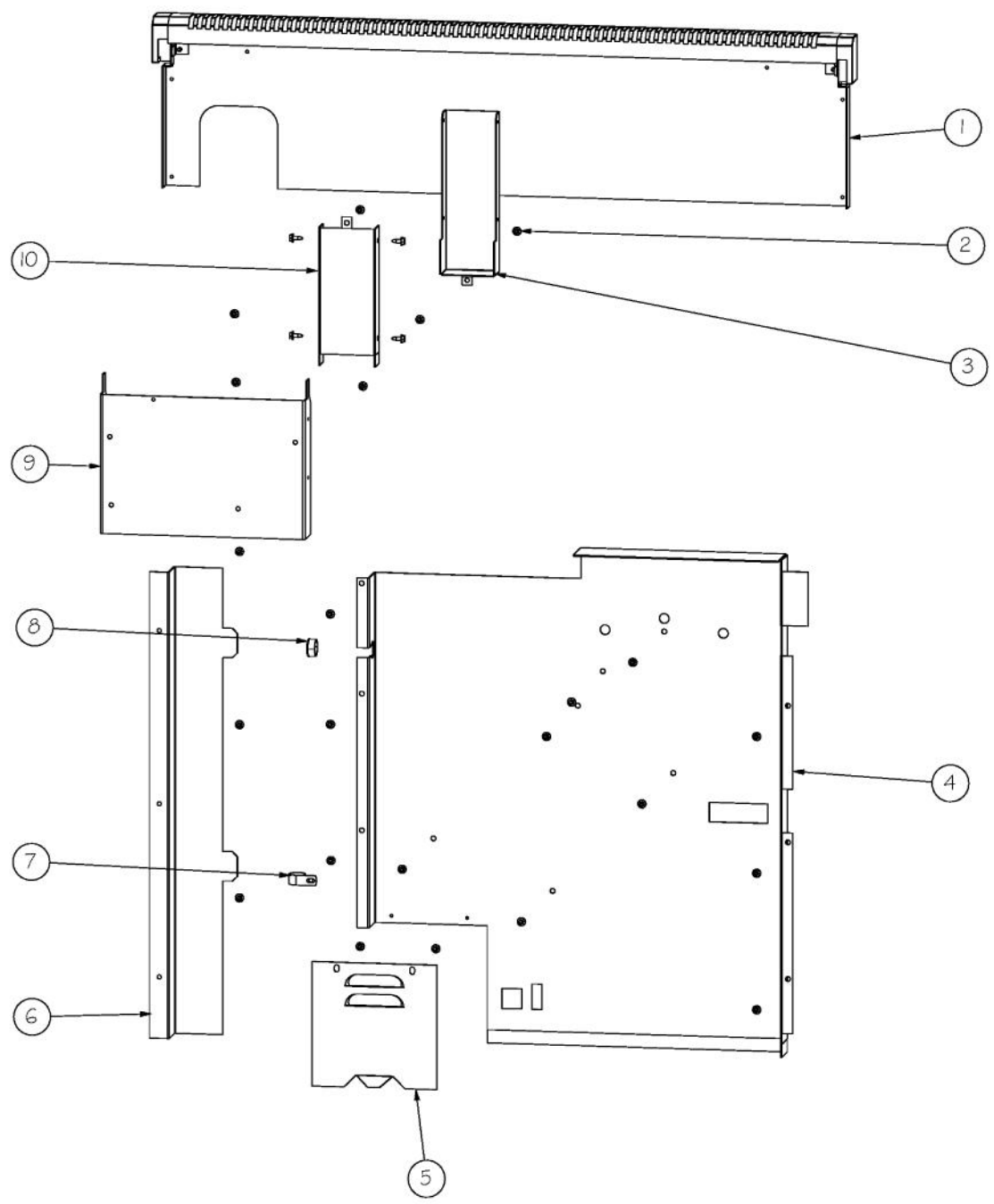

Ref #	Part Number	Qty.	Description
1	006900-000	1	ISLAND TRIM, ASM, 36 CUSTOM
2	003860-000	27	NO.10-18 X .500 FASTNR,SCR,HXWH,STL,ZPLT
3	A20010101	1	FLUE, OUTSIDE SHELL
4	003272-000	1	COVER, REAR
5	A2002454	1	BACK COVER ACCESS DOOR
6	003245-000	1	CHANNEL, WIRE, REAR
7	PD030109	1	INSULATED CLAMP
8	PD040005	1	SNAP BUSHING - 7/8
9	003681-000	1	DUCT, AIR
10	A20010102	1	FLUE, CENTER EXTENDED

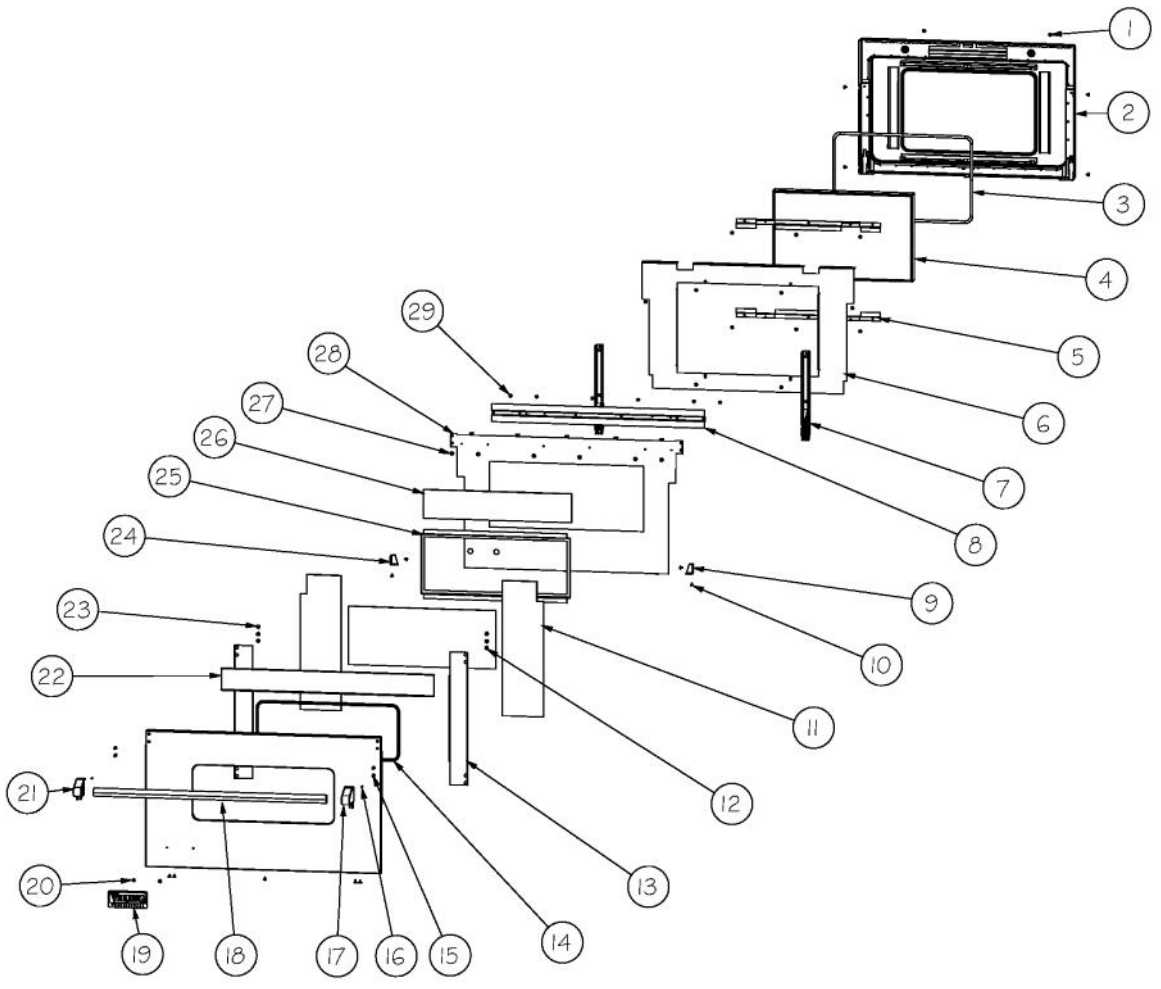

Ref #	Part Number	Qty.	Description
1	PD020063	20	SCREW-NO.8(A) X 3/8PH WFR HD/BK OXID
2	002713-402	1	LINER,DOOR ,WLD,ASSY 36 BK
3	000594-000	1	BLACK FIBERGLASS ROPE 3/8
4	PE060094	1	30 WINDOW PACK
5	004153-000	2	DOOR GLASS HOLDER BRACKET
6	006076-000	1	DOOR LINER INSULATION RETAINER, 36
7	013290-000	2	HINGE, DOOR, VGCC36 - PINK SPRING
8	006089-000	1	DOOR SKIN MTG BRACKET ASSY, 36
9	006807-000	1	HINGE, BRKT, RH
10	PD020032	7	SRW-8(A)X3/8PH.WFR HD 7/16DIAXNICL
11	006086-000	2	DOOR, SKIN, INSULATION, SIDE, 36
12	PD020073	2	SRW NO.10 X 24 X 3/8 WAFER HD TYPE23
13	002726-000	2	DOOR SKIN SIDE BRACKET
14	PE060105	1	30 J-MOLD (CHROME) NOT FIELD REPLACEABLE
15	002736-000	3	NO.10-32 PAN HEAD PHILLIPS MACHINE SCREW
16	003650-000	2	SET SCREW
17	003012-000	1	DOOR HANDLE ENDCAP ASSY, RH (CHROME)
17	003012-100	1	DOOR HANDLE ENDCAP ASSY, RH (BRASS)
18	006080-000	1	36 DOOR HANDLE, SST
19	PE010030	1	LOGO, 6, PRO, BK
19	PE010079	1	4.5 LOGO/VIKING PROF, BK/BR
20	PD030006	2	CAPPED WASHER PAL NUT
21	003011-000	1	DOOR HANDLE ENDCAP ASSY, LH (CHROME)
21	003011-100	1	DOOR HANDLE ENDCAP ASSY, LH (BRASS)
22	006082-000	1	DOOR SKIN HEAT SINK, 36
23	004907-000	4	STEEL FINISHING PLUG, NICKEL PLTD 25/64 HOLE
24	006808-000	1	HINGE, BRKT, LH
25	L20014077	1	30 WINDOW HOLDER NOT FIELD REPLACEABLE
26	006788-000	1	INSULATION,DOOR,TOP,SUPERWOOL,,25,VDSC530
27	PD020033	6	SRW-NO.10-24X1/2T(23)PH.WFR HD (NKL)
28	006084-000	1	DOOR SKIN INSULATION RETAINER, 36
29	PD030010	6	NO.10-24 KEPS NUT
NI	021311-000	1	DOOR SKIN SERVICE ASSEMBLY, SS
NI	021312-002	1	DOOR SKIN SERVICE ASSEMBLY, BK
NI	021312-003	1	DOOR SKIN SERVICE ASSEMBLY, BT
NI	021312-004	1	DOOR SKIN SERVICE ASSEMBLY, SG
NI	021312-005	1	DOOR SKIN SERVICE ASSEMBLY, GG
NI	021312-006	1	DOOR SKIN SERVICE ASSEMBLY, WH
NI	021312-008	1	DOOR SKIN SERVICE ASSEMBLY, BU
NI	021312-009	1	DOOR SKIN SERVICE ASSEMBLY, LE
NI	021312-010	1	DOOR SKIN SERVICE ASSEMBLY, MJ
NI	021312-012	1	DOOR SKIN SERVICE ASSEMBLY, VB
NI	021312-013	1	DOOR SKIN SERVICE ASSEMBLY, CB
NI	021312-015	1	DOOR SKIN SERVICE ASSEMBLY, PL
NI	021312-016	1	DOOR SKIN SERVICE ASSEMBLY, CH
NI	021312-017	1	DOOR SKIN SERVICE ASSEMBLY, TP
NI	021312-018	1	DOOR SKIN SERVICE ASSEMBLY, CW
NI	021312-019	1	DOOR SKIN SERVICE ASSEMBLY, OG
NI	021312-020	1	DOOR SKIN SERVICE ASSEMBLY, GM
NI	021312-021	1	DOOR SKIN SERVICE ASSEMBLY, SA
NI	021312-022	1	DOOR SKIN SERVICE ASSEMBLY, SE
NI	021312-023	1	DOOR SKIN SERVICE ASSEMBLY, IB
NI	021312-024	1	DOOR SKIN SERVICE ASSEMBLY, AR
NI	021312-025	1	DOOR SKIN SERVICE ASSEMBLY, RR
NI	021312-026	1	DOOR SKIN SERVICE ASSEMBLY, PM
NI	021312-027	1	DOOR SKIN SERVICE ASSEMBLY, MS
NI	006100-000	1	DOOR ASSEMBLY, 36 - SS
NI	009915-002	1	DOOR ASSEMBLY, 36 - BK
NI	009915-003	1	DOOR ASSEMBLY, 36 - BT
NI	009915-004	1	DOOR ASSEMBLY, 36 - SG

Ref #	Part Number	Qty.	Description
NI	009915-004	1	DOOR ASSEMBLY, 36 - SG
NI	009915-005	1	DOOR ASSEMBLY, 36 - GG
NI	009915-006	1	DOOR ASSEMBLY, 36 - WH
NI	009915-008	1	DOOR ASSEMBLY, 36 - BU
NI	009915-009	1	DOOR ASSEMBLY, 36 - LE
NI	009915-010	1	DOOR ASSEMBLY, 36 - MJ
NI	009915-012	1	DOOR ASSEMBLY, 36 - VB
NI	009915-013	1	DOOR ASSEMBLY, 36 - CB
NI	009915-015	1	DOOR ASSEMBLY, 36 - PL
NI	009915-016	1	DOOR ASSEMBLY, 36 - CH
NI	009915-017	1	DOOR ASSEMBLY, 36 - TP
NI	009915-018	1	DOOR ASSEMBLY, 36 - CW
NI	009915-019	1	DOOR ASSEMBLY, 36 - OG
NI	009915-020	1	DOOR ASSEMBLY, 36 - GM
NI	009915-021	1	DOOR ASSEMBLY, 36 - SA
NI	009915-022	1	DOOR ASSEMBLY, 36 - SE
NI	009915-023	1	DOOR ASSEMBLY, 36 - IB
NI	009915-024	1	DOOR ASSEMBLY, 36 - AR
NI	009915-025	1	DOOR ASSEMBLY, 36 - RR
NI	009915-026	1	DOOR ASSEMBLY, 36 - PM
NI	009915-027	1	DOOR ASSEMBLY, 36 - MS
NI	006100-100	1	DOOR ASSEMBLY - SS/BR, 36
NI	009915-102	1	DOOR ASSEMBLY, 36 - BK/BR
NI	009915-103	1	DOOR ASSEMBLY, 36 - BT/BR
NI	009915-104	1	DOOR ASSEMBLY, 36 - SG/BR
NI	009915-105	1	DOOR ASSEMBLY, 36 - GG/BR
NI	009915-106	1	DOOR ASSEMBLY, 36 - WH/BR
NI	009915-108	1	DOOR ASSEMBLY, 36 - BU/BR
NI	009915-109	1	DOOR ASSEMBLY, 36 - LE/BR
NI	009915-110	1	DOOR ASSEMBLY, 36 - MJ/BR
NI	009915-112	1	DOOR ASSEMBLY, 36 - VB/BR
NI	009915-113	1	DOOR ASSEMBLY, 36 - CB/BR
NI	009915-115	1	DOOR ASSEMBLY, 36 - PL/BR
NI	009915-116	1	DOOR ASSEMBLY, 36 - CH/BR
NI	009915-117	1	DOOR ASSEMBLY, 36 - TP/BR
NI	009915-118	1	DOOR ASSEMBLY, 36 - CW/BR
NI	009915-119	1	DOOR ASSEMBLY, 36 - OG/BR
NI	009915-120	1	DOOR ASSEMBLY, 36 - GM/BR
NI	009915-121	1	DOOR ASSEMBLY, 36 - SA/BR
NI	009915-122	1	DOOR ASSEMBLY, 36 - SE/BR
NI	009915-123	1	DOOR ASSEMBLY, 36 - IB/BR
NI	009915-124	1	DOOR ASSEMBLY, 36 - AR/BR
NI	009915-125	1	DOOR ASSEMBLY, 36 - RR/BR
NI	009915-126	1	DOOR ASSEMBLY, 36 - PM/BR
NI	009915-127	1	DOOR ASSEMBLY, 36 - MS/BR
NI	006996-000	1	DOOR GASKET, 36

*No Image
Available*

Ref #	Part Number	Qty.	Description
NI	024909-000	1	SHIELD, WRG
NI	015103-000	1	HARNESS,TEST,VDSC-T MODELS
NI	PE070735	1	MEAT PROBE HARNESS
NI	015100-000	1	HARNESS,WIRING,VDSC530-T
NI	015103-000	1	HARNESS,TEST,VDSC-T MODELS
NI	G4000936	1	GROUND WIRE
NI	PE070739	1	BAKE ELEMENT HARNESS
NI	006766-000	3	IRIS IGNITOR WIRE, BACK BURNER
NI	PE070643	2	SPARK IGNITOR WIRE - 30KVDC
NI	023340-000	1	IRIS HARNESS, 36
NI	007378-000	1	LIGHT SWITCH HARNESS
NI	000647-000	3	IRIS IGNITOR WIRE, FRONT BURNER
NI	006766-000	3	IRIS IGNITOR WIRE, BACK BURNER