

This Owner's Manual is provided and hosted by [Appliance Factory Parts](#).

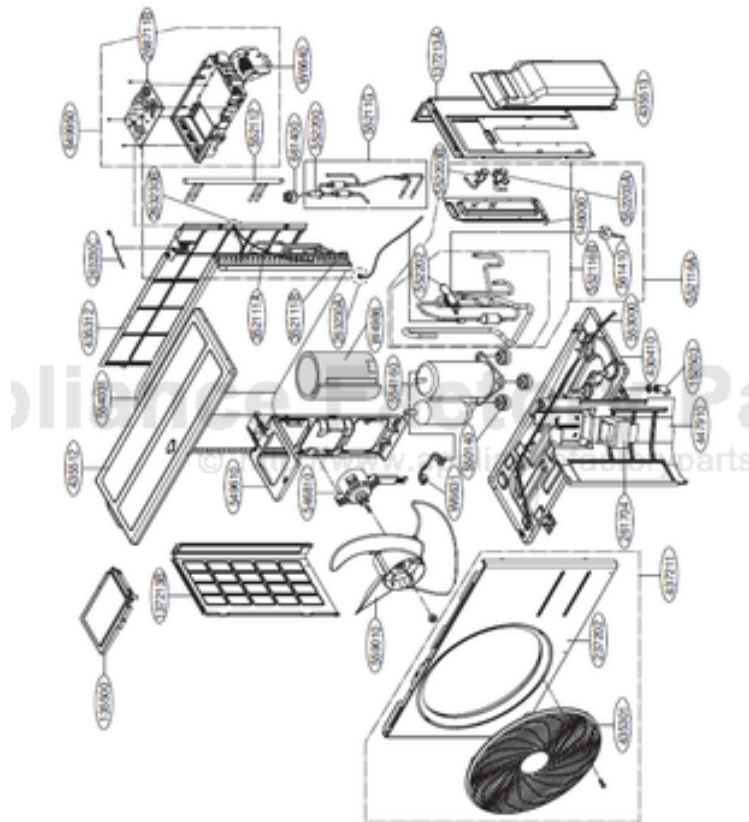

LG AS-W123B1Y9 Owner's Manual

[Shop genuine replacement parts for LG AS-W123B1Y9](#)



[Find Your LG Air Conditioner Parts - Select From 2330 Models](#)

----- Manual continues below -----



Internal Use Only

<http://biz.lgservice.com>

Room Air Conditioner

SVC MANUAL(Exploded View)

**MODEL : AS-W093BRM9(LAN090HSV2/LAU090HSV2)
AS-W123BRM9(LAN120HSV2/LAU120HSV2)
AS-W093B1Y9(LSN091HSV2/LSU091HSV2)
AS-W123B1Y9(LSN121HSV2/LSU121HSV2)**

CAUTION

Before Servicing the unit, read the safety precautions in General SVC manual.
Only for authorized service personnel.

1. Specification

Models		Unit	AS-W093BRM9	AS-W123BRM9	AS-W093B1Y9	AS-W123B1Y9	
Cooling Capacity		kW	0.89~2.64~3.70	0.89~3.3~4.30	0.89~2.64~3.70	0.89~3.3~4.30	
		Btu/h.	3,070~9,000~12,620	3,070~11,200~14,660	3,070~9,000~12,620	3,070~11,200~14,660	
Heating Capacity		kW	0.89~3.17~5.00	0.89~3.90~6.00	0.89~3.17~5.00	0.89~3.90~6.00	
		Btu/h.	3,070~10,800~17,060	3,070~13,300~20,470	3,070~10,800~17,060	3,070~13,300~20,470	
Power Input	Cooling/Heating	W	677 / 700	896 / 1,000	677 / 700	896 / 1,000	
Running Current	Cooling/Heating	A	3.0 / 3.7	4.2 / 4.9	3.0 / 3.7	4.2 / 4.9	
Starting Current	Cooling/Heating	A	3.0 / 3.7	4.2 / 4.9	3.0 / 3.7	4.2 / 4.9	
EER		W/W	3.91	3.67	3.91	3.67	
		Btu/h.W	13.3	12.5	13.3	12.5	
SEER			20	20	20	20	
HSPF			11	11	11	11	
Power Supply		Ø / V / Hz	1/208-230/60	1/208-230/60	1/208-230/60	1/208-230/60	
Power Factor		%	93/97.1/93/97.1	93/97.1/93/97.1	93/97.1/93/97.1	93/97.1/93/97.1	
Air Flow Rate	Indoor,Max	m3/min(CFM)	12.0 (423)	12.0(423)	12.0 (423)	12.0(423)	
	Outdoor,Max	m3/min(CFM)	33(1,165)	33(1,165)	33(1,165)	33(1,165)	
Moisture Removal		l/h.	1.1	1.3	1.1	1.3	
Sound Level	Indoor,H/M/L	dB(A)±3	39 / 33 / 24	39 / 33 / 24	39 / 33 / 24	39 / 33 / 24	
	Outdoor,Max	dB(A)±3	45	45	45	45	
Refrigerant & Charge (at 7.5 m)		g(oz)	R410A, 1,000(35.3)	R410A, 1,000(35.3)	R410A, 1,000(35.3)	R410A, 1,000(35.3)	
Additional Refrigerant charge		g/m(oz/ft)	20(0.22)	20(0.22)	20(0.22)	20(0.22)	
Compressor	Type		Rotary	Rotary	Rotary	Rotary	
	Model		5RS102XAA21	5RS102XAA21	5RS102XAA21	5RS102XAA21	
	Motor Type		Brushless DC Motor	Brushless DC Motor	Brushless DC Motor	Brushless DC Motor	
	Oil Type		PVE(FV50S)	PVE(FV50S)	PVE(FV50S)	PVE(FV50S)	
	Oil Charge	cc	320	320	320	320	
	O.L.P. name		-	-	-	-	
Fan(Indoor)	Type		Cross Flow Fan	Cross Flow Fan	Cross Flow Fan	Cross Flow Fan	
	Motor Output	W	20	20	20	20	
Fan(Outdoor)	Type		Propeller	Propeller	Propeller	Propeller	
	Motor Type		BLDC	BLDC	BLDC	BLDC	
	Motor Output	W	43	43	43	43	
Circuit Breaker*		A	15	15	15	15	
Power Supply Cable		No.*mm2	3*1.5	3*1.5	3*1.5	3*1.5	
Power and Transmission Cable No.*mm2		No.*mm2	4*1.0 (Including Earth)	4*1.0 (Including Earth)	4*1.0 (Including Earth)	4*1.0 (Including Earth)	
Piping Connections	Liquid Side	mm(in)	6.35(1/4)	6.35(1/4)	6.35(1/4)	6.35(1/4)	
	Gas Side	mm(in)	9.52(3/8)	9.52(3/8)	9.52(3/8)	9.52(3/8)	
Drain Hose(O.D./I.D.)		mm(in)	21.5 / 16.0(0.85 / 0.63)	21.5 / 16.0(0.85 / 0.63)	21.5 / 16.0(0.85 / 0.63)	21.5 / 16.0(0.85 / 0.63)	
Dimensions	Indoor (W*H*D)	mm	895*285*205	895*285*205	895*285*195	895*285*195	
	inch		35.2*11.2*8.1	35.2*11.2*8.1	35.2*11.2*7.7	35.2*11.2*7.7	
	Outdoor (W*H*D)	mm	770*545*288	770*545*288	770*545*288	770*545*288	
	inch		30.3*21.5*11.3	30.3*21.5*11.3	30.3*21.5*11.3	30.3*21.5*11.3	
Net Weight	Indoor	kg(lbs)	11(24.5)	11(24.5)	10(22.1)	10(22.1)	
	Outdoor	kg(lbs)	35(77.2)	35(77.2)	35(77.2)	35(77.2)	
Gross Weight	Indoor	kg(lbs)	13.5(29.7)	13.5(29.7)	12(26.5)	12(26.5)	
	Outdoor	kg(lbs)	37(81.6)	37(81.6)	37(81.6)	37(81.6)	
Operation Range	Cooling(Outdoor)	°C	-10~48(14~118.4)	-10~48(14~118.4)	-10(-18)*~48(14.0(0)*~118.4)	-10(-18)*~48(14.0(0)*~118.4)	
	Heating(Outdoor)	°C	-10~24(14.0~75.2)	-10~24(14.0~75.2)	-10~24(14.0~75.2)	-10~24(14.0~75.2)	
Piping Length (Min/Max)		m(ft)	2(6.6) / 20(65.6)	2(6.6) / 20(65.6)	2(6.6) / 20(65.6)	2(6.6) / 20(65.6)	
Chargeless		m(ft)	12.5(41.0)	12.5(41.0)	12.5(41.0)	12.5(41.0)	
Max. Elevation Difference		m(ft)	10(32.8)	10(32.8)	10(32.8)	10(32.8)	
Tool Code(Chassis)	Indoor + Outdoor		SB_A + UL2	SB_A + UL2	SB_R + UL2	SB_R + UL2	
Functions	Temperature Control		Thermistor	Thermistor	Thermistor	Thermistor	
	Allergy free filter		-	-	-	-	
	Plasma Filter		O	O	O	O	
	Prefilter(washable/anti-fungus)		O	O	O	O	
	Auto Clean		O	O	O	O	
	CHAOS Wind(Auto Wind)		O	O	O	O	
	Steps, Fan/Cool/Heat		5 / 6 / 5	5 / 6 / 5	5 / 6 / 5	5 / 6 / 5	
	Airflow Direction Control(up& Down)		Auto	Auto	Auto	Auto	
	Airflow Direction Control(left & right)		Auto	Auto	Auto	Auto	
	Remote Controller Type		Wireless LCD	Wireless LCD	Wireless LCD	Wireless LCD	
	Setting Temperature Range	Cooling		18°C ~ 30°C	18°C ~ 30°C	18°C ~ 30°C	18°C ~ 30°C
		Heating		16°C ~ 30°C	16°C ~ 30°C	16°C ~ 30°C	16°C ~ 30°C
	Auto Operation (Micom Control)		-	-	-	-	
	Auto Changeover (Micom Control)		O	O	O	O	
	Self Diagnosis		O	O	O	O	
	Timer		24h, On/Off	24h, On/Off	24h, On/Off	24h, On/Off	
	Sleep Operation		O	O	O	O	
	Soft Dry Operation		O	O	O	O	
	Restart Delay(minute)		3	3	3	3	
	Deice Control(Defrost)		O	O	O	O	
	Hot Start		O	O	O	O	
	Jet Cool		O	O	O	O	
	Low Ambient Operation		O	O	O	O	
	Special Function			WATER LEVEL SENSOR (OPTIONAL)	WATER LEVEL SENSOR (OPTIONAL)	WATER LEVEL SENSOR (OPTIONAL)	WATER LEVEL SENSOR (OPTIONAL)

Note:

O : Applied, - : No relation

* For circuit breaker rating, please conform to local standards wherever necessary.

* With wind baffle accessory installed. with out wind baffle installed, the minimum temperature will be 14°F D.B.

* Some of functions are slightly different depending upon models.

* The specification may be subject to change without notice for purpose of improvement.

2. Piping Diagrams

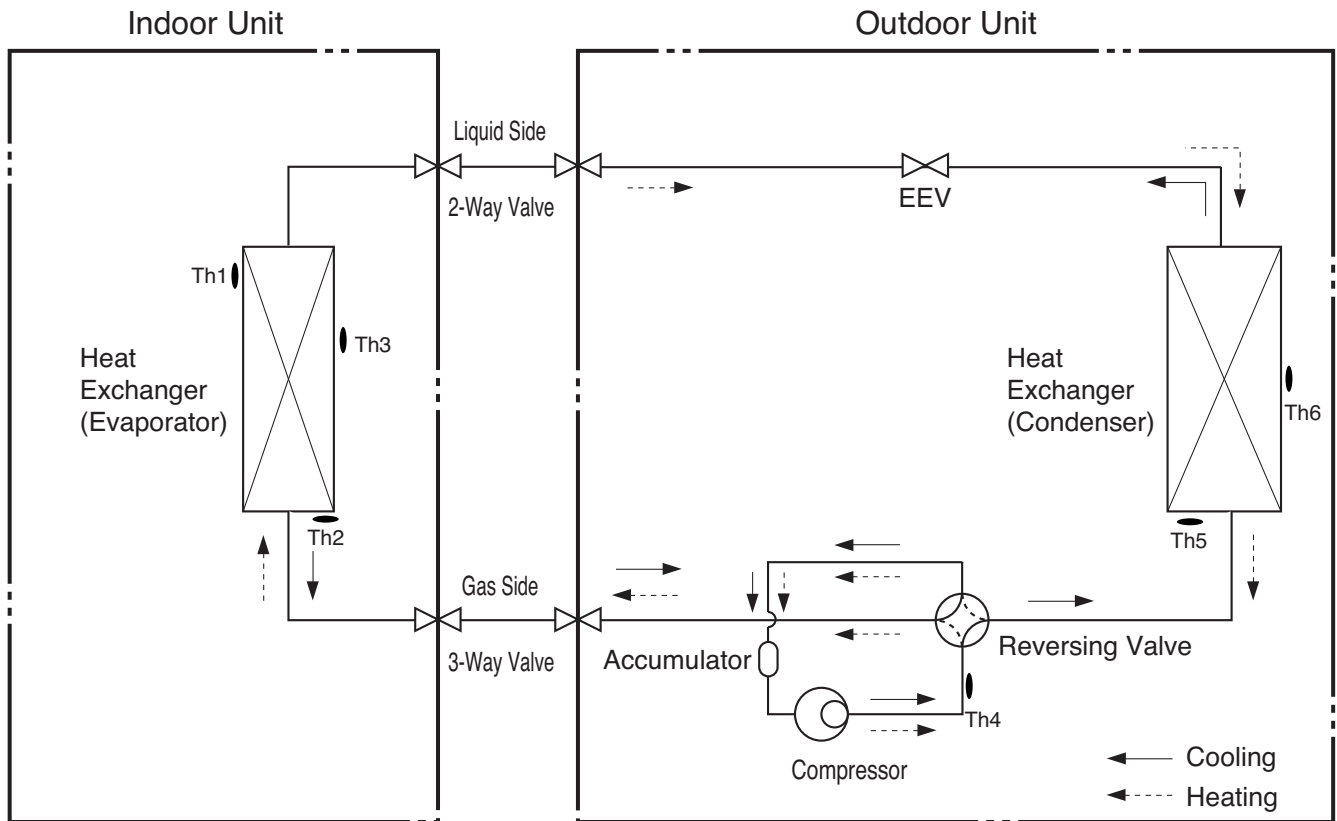

LOC.	Description	PCB Connector
Th1	Thermistor for suction air temperature	CN-TH1(Indoor)
Th2	Water Level Sensor (Option)	CN-TH2(Indoor)
Th3	Thermistor for evaporator middle temperature	CN-TH3(Indoor)
Th4	Thermistor for discharge pipe temperature	CN-TH2(Outdoor)
Th5	Thermistor for condensing temperature	CN-TH1(Outdoor)
Th6	Thermistor for outdoor air temperature	

3. Wiring Diagrams

Indoor Unit

MODEL : AS-W093BRM9, AS-W123BRM9

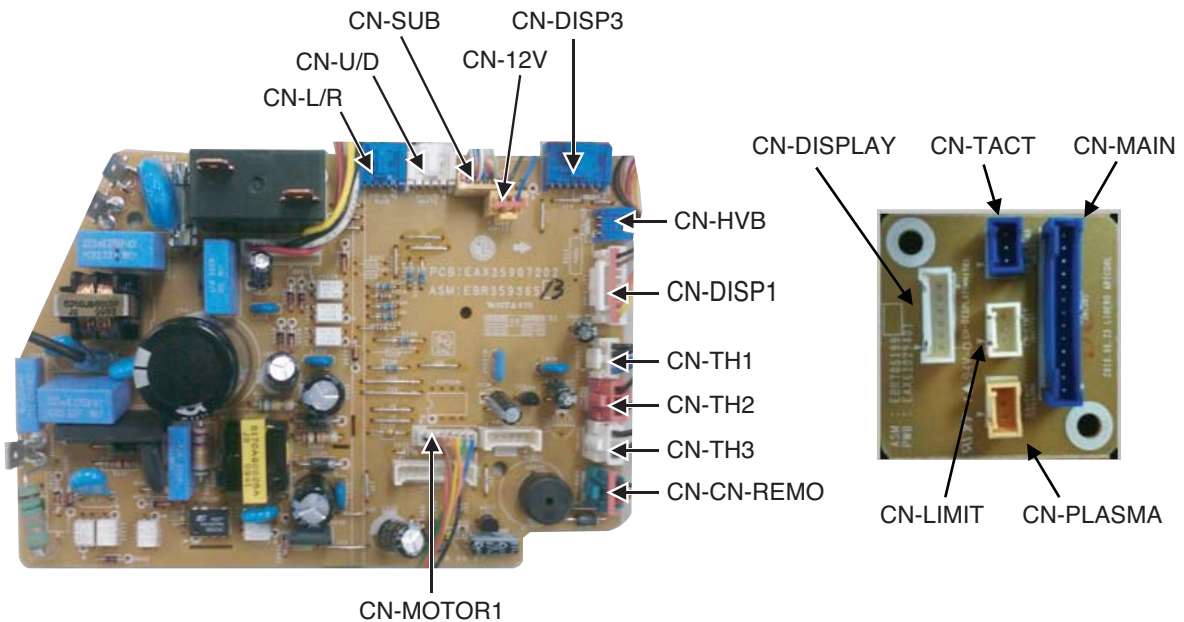
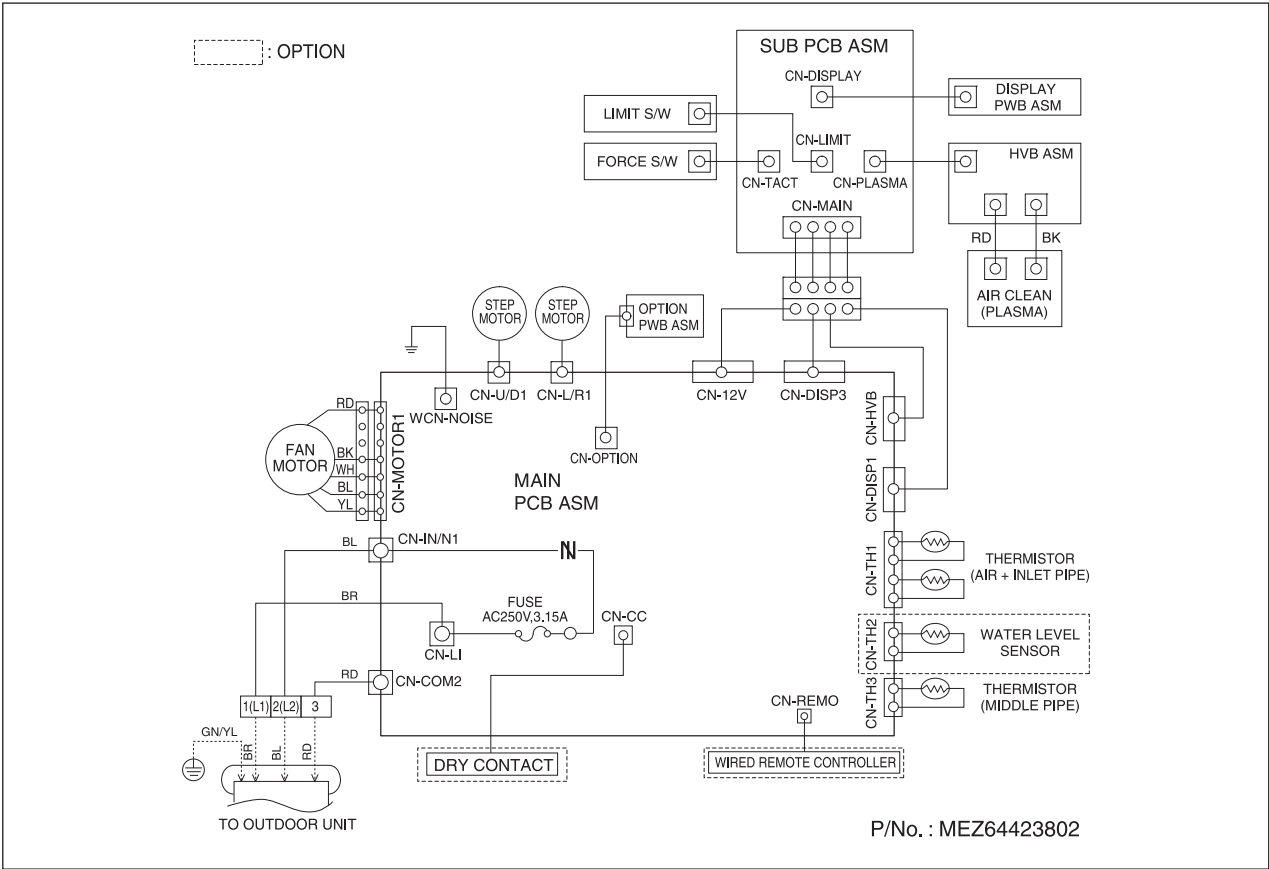

Indoor Unit

MODEL : ASNW093B1Y9, ASNW123B1Y9

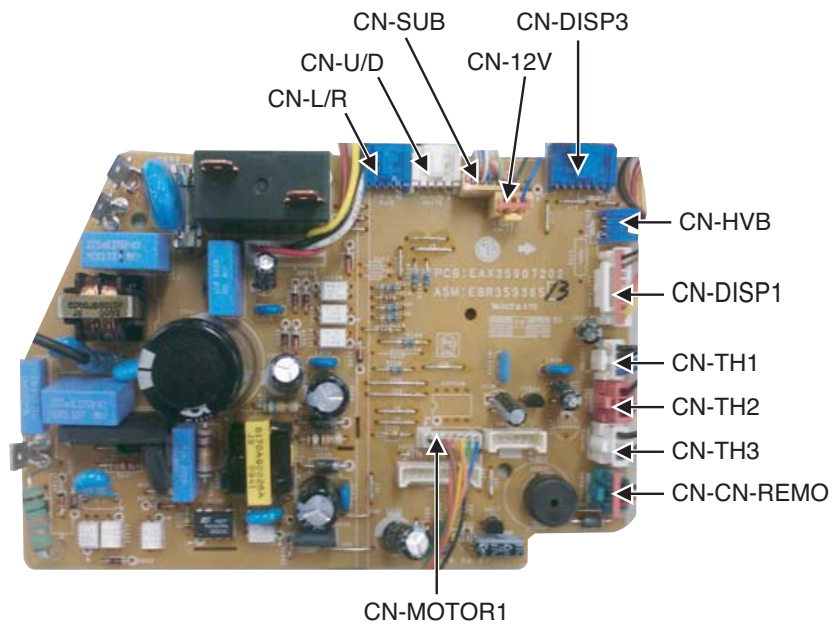
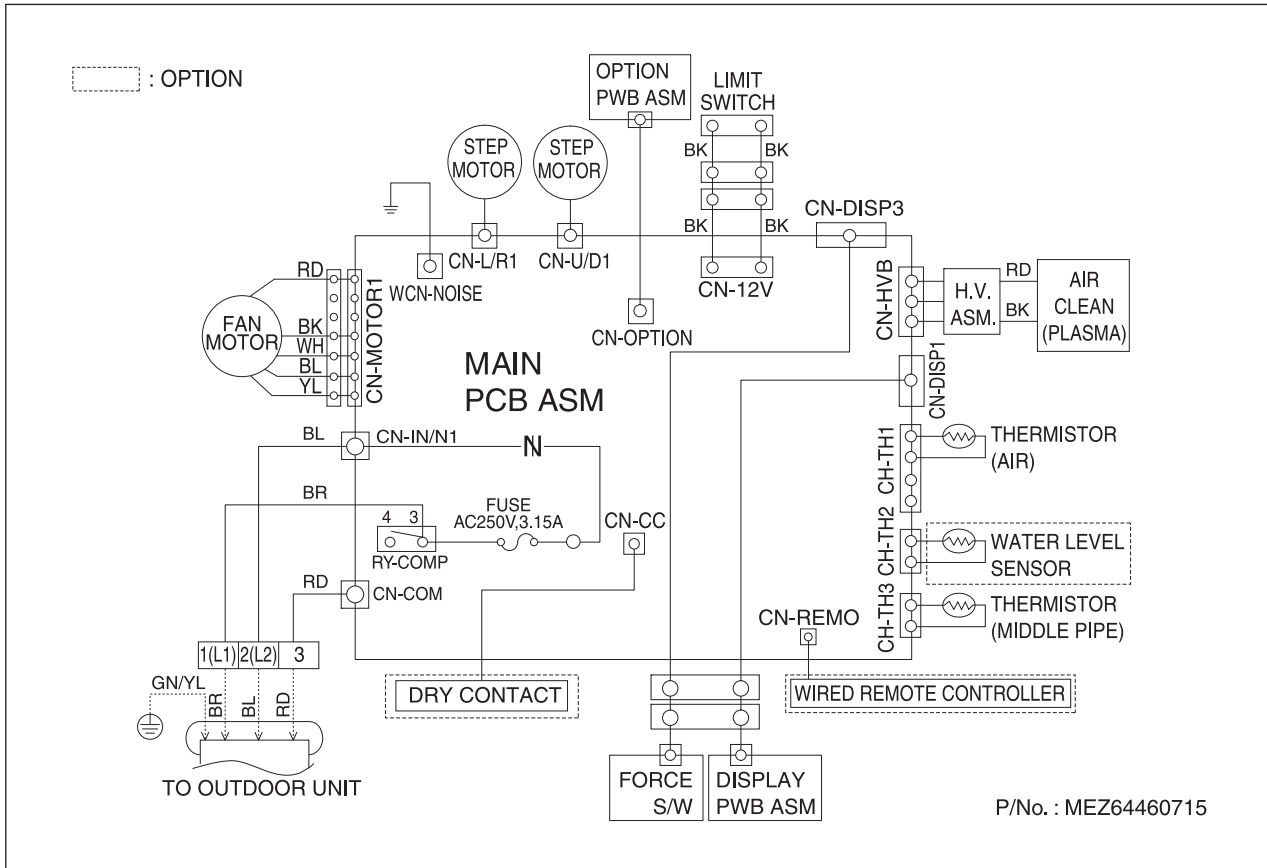

Outdoor Unit

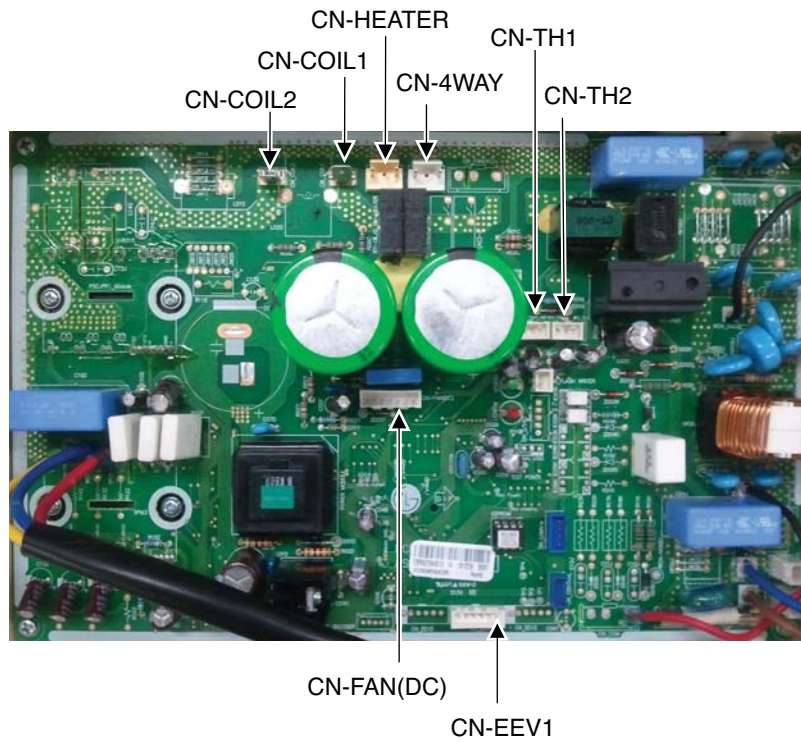
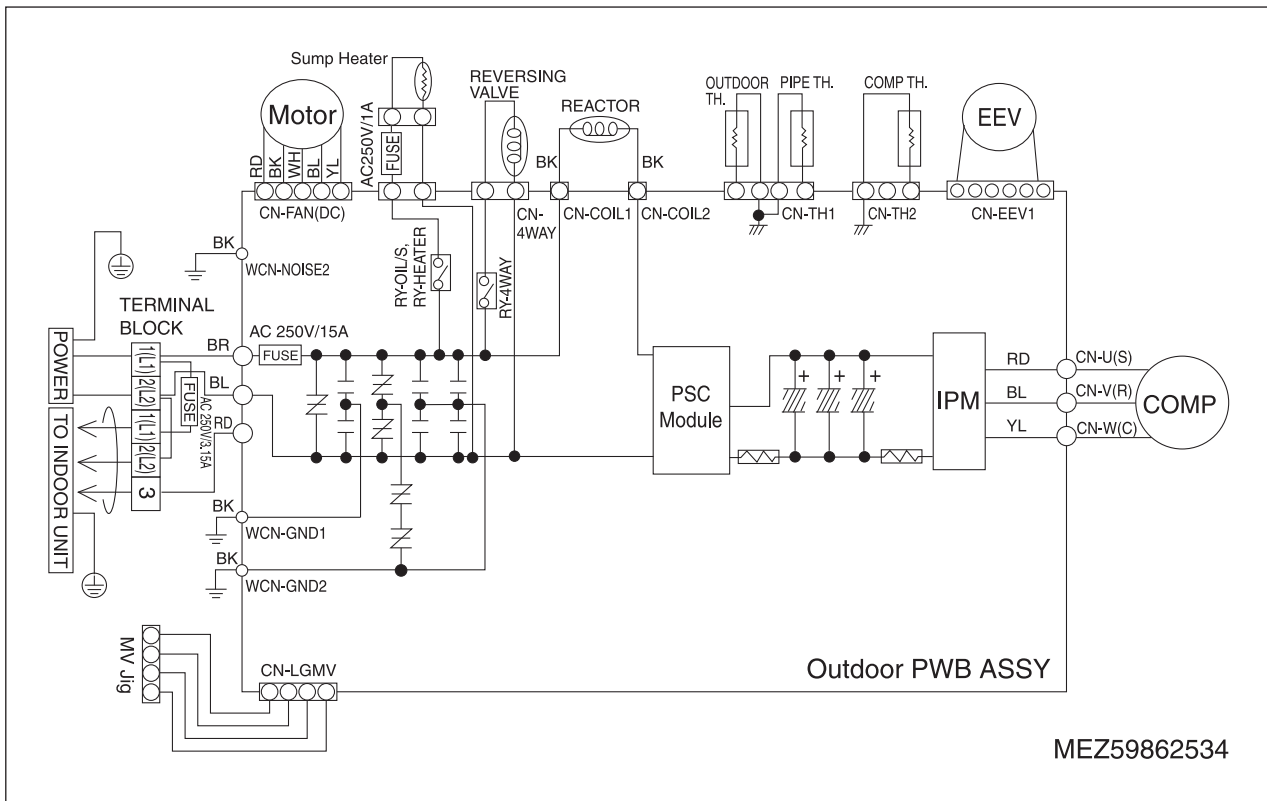

4. Exploded View

Model : AS-W093BRM9, AS-W123BRM9

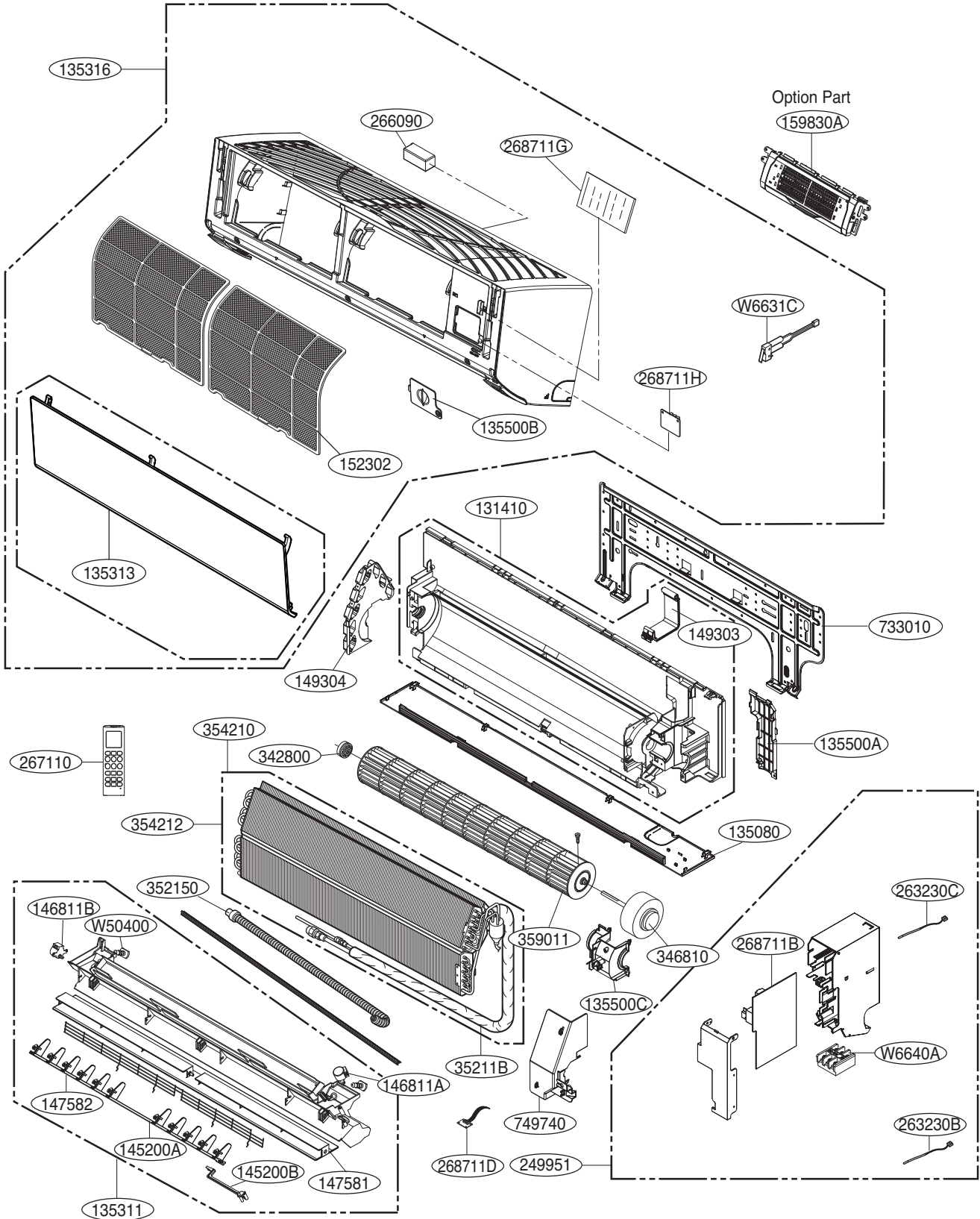

MODEL : ASNW093B1Y9, ASNW123B1Y9

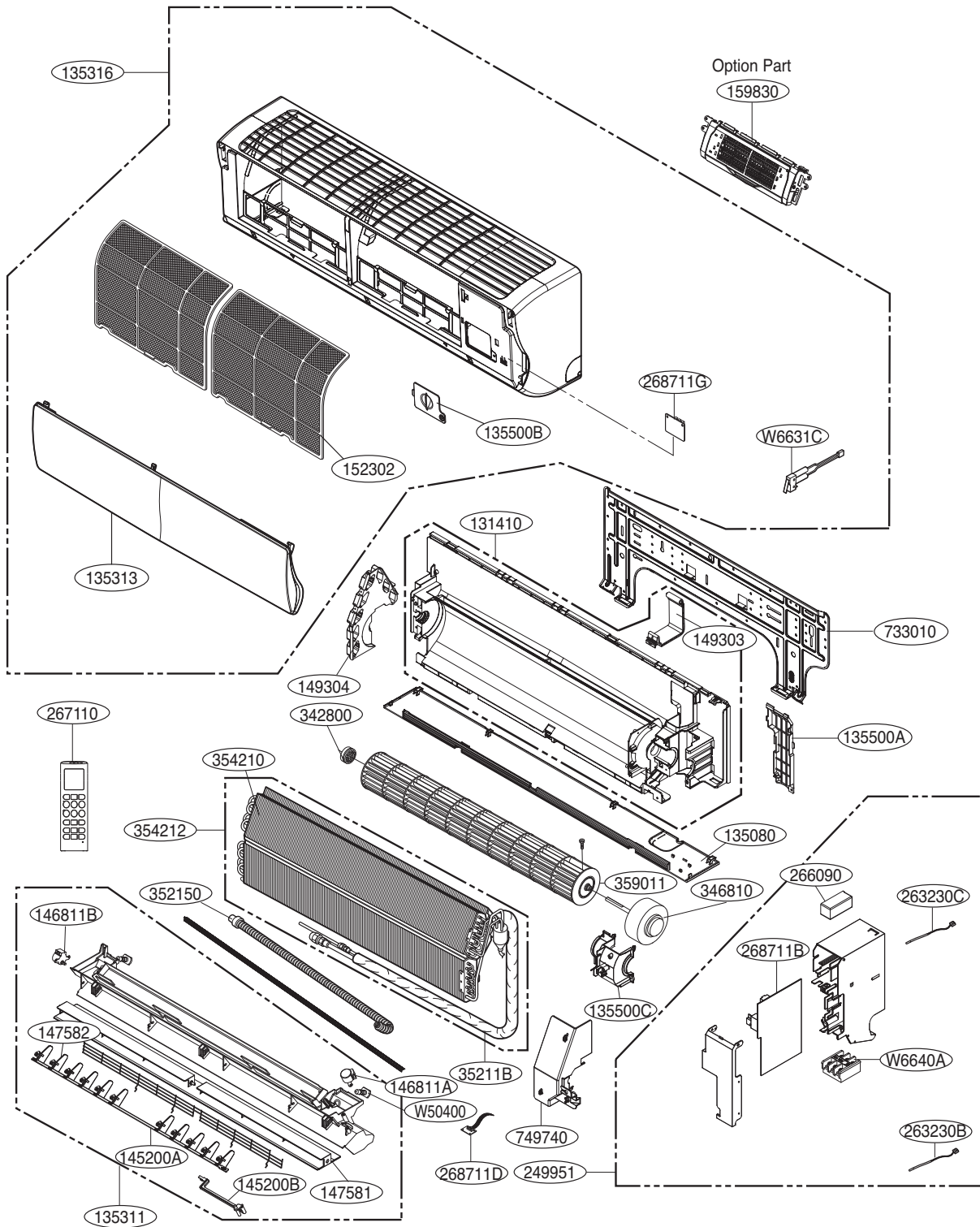

Note) * Please ensure GCSC since the replacement parts may be changed depending upon the buyer's request. Please check the correct parts in View RPL(Replacement Part List) on GCSC. (GCSC Website <http://www.lge.com>)

Outdoor Unit

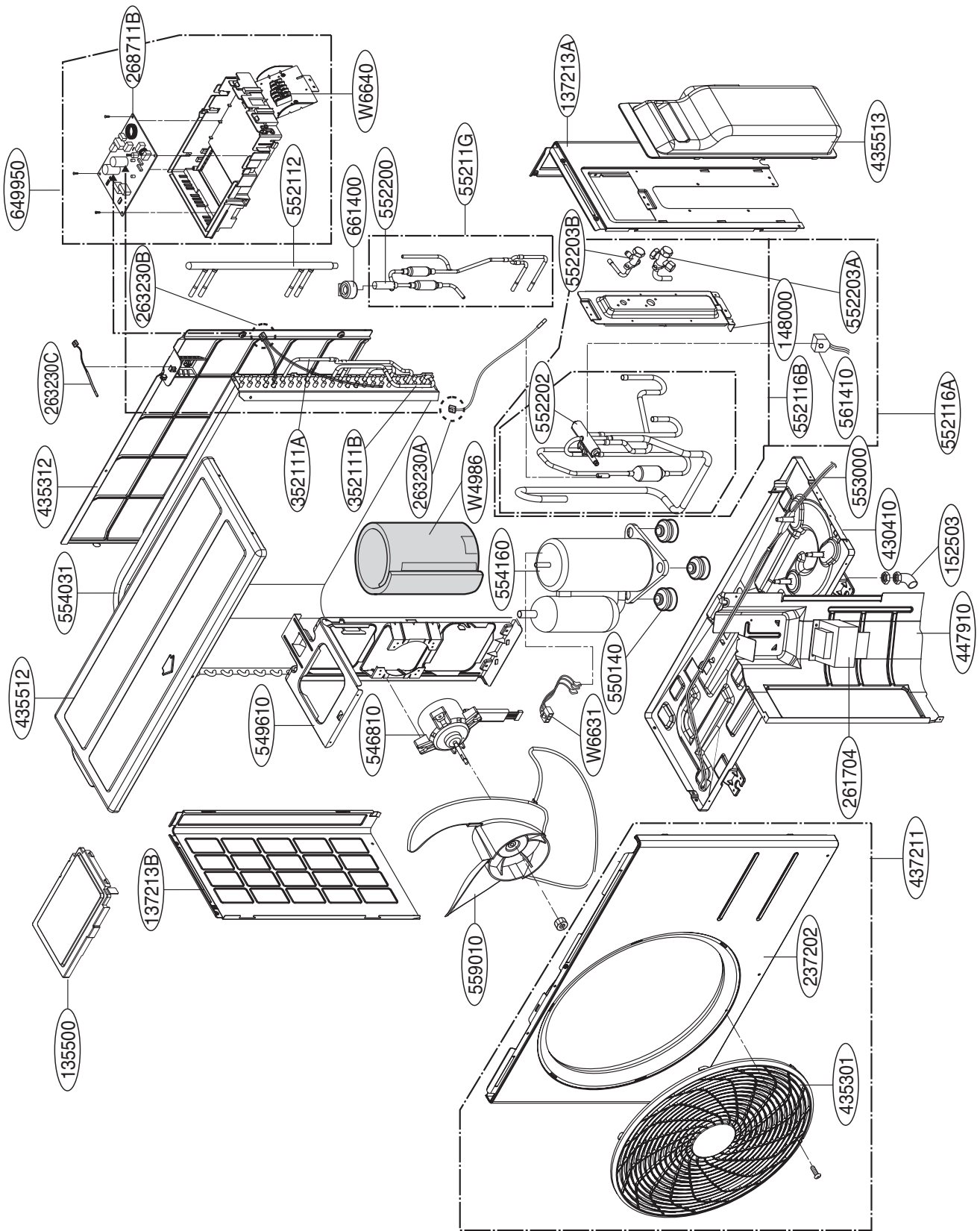



US	1. Please call the installing contractor of your product, as warranty service will be provided by them. 2. If you have service issues that have not been addressed by the contractor, please call 1-888-865-3026.
CANADA	Service call Number # : (888) LG Canada, (888) 542-2623

P/NO : MFL67501902

MAY, 2013