

This Owner's Manual is provided and hosted by [Appliance Factory Parts](#).



# Rankam TF2014501-BA Owner's Manual

[Shop genuine replacement parts for Rankam  
TF2014501-BA](#)



[Find Your Rankam Grill Parts - Select From 123 Models](#)

----- Manual continues below -----



## 18 QT. Fish Fryer With Double Basket Set

Assembly, Use and Care Manual

For Outdoor Use Only

**Model: TF2014501-BA**

Tools required:

Phillips screwdriver / Adjustable wrench



- To installer or person assembling this appliance: Leave this manual with this appliance for future reference.
- This instruction manual contains important information necessary for the proper assembly and safe use of the appliance.
- Read and follow all warnings and instructions before assembling and using the appliance.
- Follow all warnings and instructions when using the appliance.
- Keep this manual for future reference.
- This appliance is not for frying turkey.



## DANGER



If you smell gas:

1. Shut off gas to the appliance.
2. Extinguish any open flame.
3. If odor continues, keep away from the appliance and immediately call your fire department.

Failure to follow these instructions could result in fire or explosion which could cause property damage, personal injury or death.







## DANGER



1. Never operate this appliance unattended.
2. Never operate this appliance within 10 feet or 3m of any other gas cylinder.
3. Never operate this appliance within 25 feet or 7.5 m of any flammable liquid.
4. Do not fill cooking vessel beyond maximum fill line.
5. Never allow oil/grease to get hotter than 400°F or 200°C. If the temperature exceeds 400°F (200°C) or if oil begins to smoke, immediately turn the burner or gas supply OFF.
6. Heated liquids remain at scalding temperatures long after the cooking process. Never touch cooking appliance until liquids have cooled to 115°F or 45°C or less.
7. If a fire should occur, keep away from the appliance and immediately call your fire department. Do not attempt to extinguish an oil or grease fire with water.

Failure to follow these instructions could result in fire, explosion or burn hazard which could cause property damage, personal injury or death.

	<b>PROP 65 WARNING</b>	
 <b>WARNING:</b> This product can expose you to chemicals including benzene, which is known to the State of California to cause cancer and birth defects or other reproductive harm. For more information go to <a href="http://www.P65Warnings.ca.gov">www.P65Warnings.ca.gov</a> .		

	<b>WARNING</b>	
This Appliance is not intended for commercial use.		

### Safety Symbols

The symbols and boxes shown below explain what each heading means. Read and follow all of the messages found throughout the manual.

	<b>DANGER</b>	
Danger: Indicates an imminently hazardous situation which, if not avoided, will result in death or serious injury.		

	<b>WARNING</b>	
Warning: Indicates a potentially hazardous situation which, if not avoided, will result in death or serious injury.		

	<b>CAUTION</b>	
CAUTION: Indicates a potentially hazardous situation or unsafe practice which, if not avoided, may result in minor or moderate injury.		



## WARNING



1. Never leave the appliance unattended. Keep children and pets away from the appliance at all times.
2. The use of alcohol, prescription or non-prescription drugs may impair the consumer's ability to properly assemble or safely operate the appliance.
3. This appliance is for **OUTDOOR USE ONLY**. **DO NOT** use in building, garage or any other enclosed area. This appliance is not intended to be installed in or on recreational vehicle and/or boats. This appliance is not intended for and should never be used as a heater.
4. Fryer shall not be used on or in any apartment or condominium balcony or deck.
5. When cooking, the fryer / boiler must be on a level, stable noncombustible surface in an area clear of combustible material. As asphalt surface (blacktop) may not be acceptable for this purpose.
6. When cooking with oil or grease, the thermometer provided **MUST** be used. Follow instructions in this manual for proper installation and use of the thermometer. If the thermometer supplied with this fryer has been lost or damaged. A replacement thermometer must be one specified by the appliance manufacturer.
7. If the temperature exceeds 400°F (200°C) or if oil begins to smoke, immediately turn the burner or gas supply **OFF** and wait for the temperature to decrease to less than 350°F (175°C) before relighting burner according to the manufacturer's instructions. If there is a lid (cover), do not remove the lid.
8. When cooking with oil or grease, have a type BC or ABC fire extinguisher readily available. In the event of an oil or grease fire do not attempt to extinguish with water. Immediately call the fire department. A Type BC or ABC fire extinguisher may, in some circumstances contain the fire.
9. Never overfill the cooking vessel with oil, grease or water. Follow instructions in this manual for establishing proper oil, grease or water levels. Never overfill the cooking vessel with oil, grease or water than specified by vessel manufacturer instruction. If the vessel doesn't indicate the maximum fill line, please refer to following instructions for determining the maximum fill level.  
Determining the maximum fill level when using a vessel without a maximum line:
  - (1) Place the food product in the basket.
  - (2) Place the food product and holder into the empty vessel.
  - (3) Fill the vessel with water just until the food product is completely submerged. There must be a minimum of 3 inch (8 cm) between the water level and top of the vessel.
  - (4) Remove the food product from the vessel and either mark the water level on the side of the vessel or measure the amount of water in the vessel.
  - (5) Remove the water and completely dry the vessel and the food product.
  - (6) This is the amount of cooking oil the vessel is to be filled with to cook the food product.
10. Introduction of water or ice from any source into the oil/grease may cause overflow and severe burns from hot oil and water splatter. When frying with oil/grease, all food products **MUST** be completely thawed and towel dried before being immersed in the fryer.

11. Do not place empty cooking vessel on the appliance while in operation. Use caution when placing anything in cooking vessel while the appliance is in operation. Placing an empty cooking vessel on the appliance while in operation will result in melting the cooking vessel. Use caution when placing anything in cooking vessel while the appliance is in operation.
12. In the event of rain, snow, hail, sleet or other forms of precipitation while cooking with oil or grease, cover the cooking vessel immediately and turn off appliance burners and gas supply. Do not attempt to move the appliance or cooking vessel.
13. Do not move the appliance when in use. Allow the cooking vessel to cool to 115°F (45°C) before moving or storing.
14. Do not leave the appliance unattended, keep children and pets away from the appliance at all times.



## WARNING



### Installation Safety Precautions.

- Use appliance only with LP (propane) gas and the regulator/ valve assembly supplied.
- Installation must conform with local codes or, in the absence of local codes, with the *National Fuel Gas Code, ANSI Z223.1/NFPA 54, Storage and Handling of Liquefied Petroleum Gases, ANSI/NFPA 58; or Natural Gas and Propane Installation Code, CSA B1 49.1*
- This appliance shall be used only outdoors, and shall not be used in a building, garage or any other enclosed area.
- Use appliance at least 10 ft. from any wall or surface. Maintain 10 ft clearance to objects that can catch fire or source of ignition such as pilot lights on water heaters, live electrical appliances, etc. Never use under balconies made of wood or ANY overhead construction.
- Apartment Dwellers: Check with management to learn the requirements and fire codes for using an LP Gas appliance at an apartment. If allowed use outside at an apartment. If allowed, use outside on the ground floor with a ten (10) foot clearance form walls or rails.
- Before opening LP tank valve, check the coupling nut for tightness. When appliance is not in use, turn off control knob and LP tank valve.
- Never move appliance while in operation or still hot.
- If you notice grease or other hot material dripping from appliance onto valve, hose or regulator, turn off gas supply at once. Determine the cause, correct, clean and inspect valve, hose and regulator before continuing. Perform a leak test.
- The regulator may make a humming or whistling noise during operation. This will not affect safety or use of appliance.
- Clean and inspect the hose before each use of the appliance. If there is evidence of abrasion, wear, cuts or leaks, the hose must be replaced prior to the appliance being put into operation.

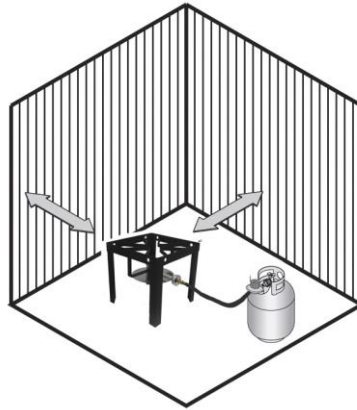



## WARNING



- Never use a cooking vessel larger than 18 qts., diameter greater than 13 x 16 inches and taller than 5 inches. **A BIGGER VESSEL MAY RESULT IN TIPPING.**
- Never fill pot above upper fill line. Oil can splatter causing staining or discoloration to ground surface.
- Never place empty cooking vessel on the appliance while in operation. Use caution when placing anything in the cooking vessel while the appliance is in operation.
- Never move the appliance when in use. Allow the cooking vessel to cool before moving or storing.
- Never leave the appliance unattended. Keep children and pet away from the appliance at all times.
- This appliance is not intended for and should never be used as a heater.

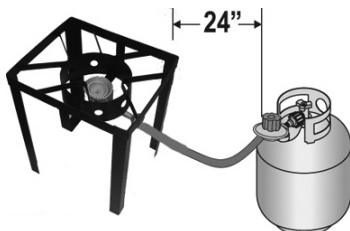

**Keep the fuel supply hose away from any heated surface**

- Never operate appliance with LP tanks out of correct position specified in assembly instructions.
- Always close LP tank valve and remove coupling nut before moving LP tank from specified operating position.
- Appliance shall not be used for commercial cooking.
- This appliance will be hot during and after use. Use insulated oven mitts or gloves for protection from hot surfaces or splatter from cooking liquids.
- Avoid bumping of or impact with the appliance to prevent spillage or splashing of hot cooking liquid.
- Never drop food or accessories into hot cooking liquid. Lower food and accessories slowly into the cooking liquid in order to prevent splashing or overflow. When removing food from the appliance care should be taken to avoid burns from hot cooking liquids.



## DANGER



- The safety relief valve on the LP tank could activate releasing gas and cause an intense fire with risk of death or serious injury. Therefore, follow instructions bulleted below exactly.
  - (a) Do not store a spare LP-gas cylinder under or near this appliance.
  - (b) Never fill the cylinder beyond 80 percent full; and
  - (c) If the instructions in (a) and (b) are not followed exactly, a fire causing death or serious injury may occur.
- If you see, smell, or hear escaping gas, immediately get away from the LP tank/appliance and call your fire department.
- All spare LP tanks must have safety caps installed on the LP tank outlet.

### LP Tank Removal, Transport and Storage

- Turn OFF all control knobs and LP tank valve. Turn coupling nut counterclockwise by hand only – do not use tools to disconnect. Install safety cap as directed may result in serious personal injury and/or property damage.
- A disconnected LP tank in storage or being transported must have a safety cap installed (as shown). Do not store an LP tank in enclosed spaces such as a carport, garage, porch, covered patio or other building. Never leave an LP tank inside a vehicle which may become overheated by the sun.
- Do not store LP tanks in an area where children play.
- Turn off gas at supply cylinder when not in use.

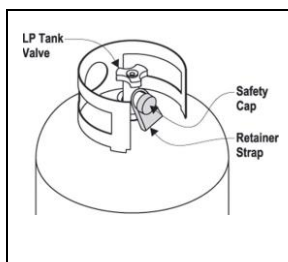

### LP Tank

The LP tank used with your appliance must meet the following requirements:

- Purchase LP tanks only with these required measurements: 12" (30.5cm) (diameter) x 18" (45.7cm) (tall) with 20lb. (9kg) capacity maximum.
- The LP-gas supply cylinder to be used must be constructed and marked in accordance with the specifications for LP-gas cylinders of the US Department of Transportation (DOT) or the National Standard of Canada, CAN/CSA-B339, Cylinders, Spheres and Tubes for the Transportation of Dangerous Goods.

### LP tank valve must have:

- Type 1 outlet compatible with regulator or appliance.
- Safety relief valve.
- UL listed Overfill Protection Device (OPD). This OPD safety feature is identified by a unique triangular hand wheel. Use only tanks equipped with this type of valve.
- LP tank must be arranged for vapor withdrawal and include collar to protect LP tank valve.



### LP (Liquefied Petroleum Gas)

- LP gas is non toxic, odorless and colorless when produced. For your safety, LP gas has been an odor (similar to rotten cabbage) so that it can be smelled.
- LP gas is highly flammable and may ignite unexpectedly when mixed with air.

### LP Tank Filling

- Use only licensed and experienced dealers.
- LP dealer must purge tanks before filling.
- Dealer should NEVER fill LP tank more than 80% of LP tank volume. Volume of propane in tanks will vary by temperature.
- A frosty regulator indicates gas overfill. Immediately close LP tank valve and call LP gas dealer for assistance.
- Do not release liquid propane (LP) gas into the atmosphere. This is a hazardous practice.
- To remove gas from LP tank, contact an LP dealer or call a local fire department for assistance. Check the telephone directory under "GAS Companies" for nearest certified LP dealers.

### LP Tank Exchange

- Many retailers that sell appliances offer you the option of replacing your empty LP tanks through an exchange service, Use only those reputable exchange companies that inspect, precision fill, test and certify their cylinders. Exchange your tank only for an OPD safety feature-equipped tanks as described in the "LP Tank" section of this manual.
- Always keep new and exchanged LP tanks in upright position during use, transit or storage.
- Leak test new and exchanged LP tanks BEFORE connecting to appliance.

### LP Tank Leak Test

For your safety

- Leak test must be repeated each time LP tank is exchanged or refilled.
- Do not smoke during leak test.
- Do not use an open flame to check for gas leaks.
- Appliance must be leak checked outdoors in well-ventilated area, away from open flames or sparks.

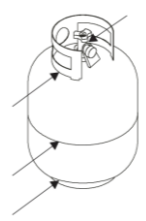

Use a clean paint brush and 50/50 soap and water solution.

**Use mild soap and water. Do not use household cleaning agents.** Damage to gas train components can result.

Brush soapy solution onto all weld seams and entire valve area.



# WARNING



If "growing" bubbles appear, do not use or move the LP tank. Contact an LP gas supplier or your fire department.

## Connecting Regulator to the LP Tank

1. Place LP tank on a secure, level, and stable surface.
2. Turn control knob to the OFF position.
3. Turn LP tank OFF by turning hand wheel clockwise to a **full stop**.
4. Remove the protective cap from the LP tank valve. Always use cap and strap supplied with valve.

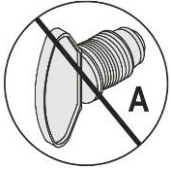



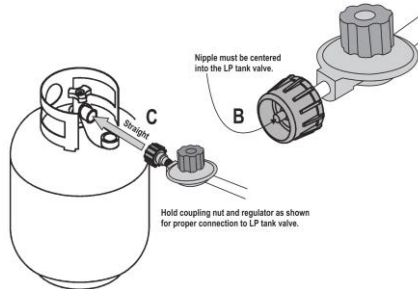

Do not use a POL transport plug (A) (plastic part with external threads)! It will defeat the safety feature of the valve.

5. Hold regulator, insert nipple (B) into LP tank valve. Hand tighten coupling nut, holding regulator in a straight line (C) with LP tank valve so as not to cross thread the connection.
6. Turn the coupling nut clockwise to tighten to a full solid stop. The regulator will seal on the back-check feature in the LP tank valve, resulting in some resistance. An additional one-half to three quarters turn is required to complete connection. Tighten by hand only – do not use tools.



**NOTE:** If you cannot complete connection, disconnect regulator and repeat step 5 and 6. If you are still unable to complete the connection, **do not use this regulator!**

	WARNING	
<ul style="list-style-type: none"> <li>● Do not insert any tool or foreign object into the valve outlet or safety relief valve. You may damage the valve and cause a leak. Leaking propane may result in explosion, fire, severe personal injury, or death.</li> <li>● Never attempt to attach this appliance to the self-contained LP gas system of a camper or trailer or motor home.</li> <li>● The pressure regulator and hose assembly supplied with the appliance must be used. Replacement pressure regulator and hose assemblies must be those specified by the appliance manufacturer.</li> <li>● Turn off gas at supply cylinder when not in use.</li> </ul>		
	WARNING	
<ul style="list-style-type: none"> <li>● Do not use appliance until leak checked.</li> <li>● If leak is detected at any time, STOP.</li> <li>● If you cannot stop a gas leak, immediately close LP tank valve, leave area of appliance, and call LP gas supplier or your fire department!</li> </ul>		

**Leak Testing Valves, Hoses and Regulator**

1. Turn all control knob(s) to OFF.
2. Be sure regulator is tightly connected to LP tanks.
3. Completely open LP tank valve by turning hand wheel counterclockwise. If you hear a rushing sound, turn gas off immediately. There is a major leak at the connection. Correct before proceeding.
4. Brush soapy solution onto indicated connections shown at right in A and B. (Reference connection of hose to burner on page 15.)
5. If "growing" bubbles appear, there is a leak. Close LP tank valve immediately and retighten connections. If leaks cannot be stopped, do not try to repair. Call for replacement parts. Order new parts by giving the serial number, number and name of items needed to the Customer Service Center at 1-888-837-1380. Use only replacement parts specified by manufacturer.
6. Always close LP tank valve after performing tank test by turning hand wheel clockwise.

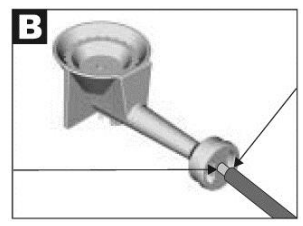
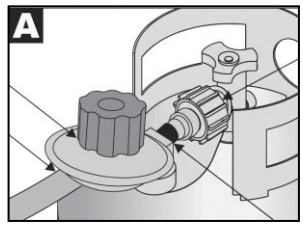

### Lighting Instructions

Do not lean over LP cooker while lighting.

1. Turn regulator control valve to OFF position.
2. Fully open LP tank valve.
3. Light match and place it over burner. Slowly turn ON the regulator control valve. DO NOT stand with head or arms over cooker.
4. If ignition does not occur in 5 seconds, turn the burner control(s) off, wait 5 minutes, and repeat the lighting procedure.

Curing of paints and parts will produce an odor only on first use.



## CAUTION



If burner does not light OR if burner flame is accidentally extinguished, turn knob to OFF, wait 5 minutes, try again. If the burner does not ignite with valve open OR if burner flame is accidentally after lighting, gas will continue to flow out of the burner and could accidentally ignite with risk of injury.

### Burner Flame Check

- Light burner, rotate knob from HIGH to LOW. You should see a smaller flame in LOW position than seen on HIGH. Always check flame prior to each use. The air damper (D) mounted on the back

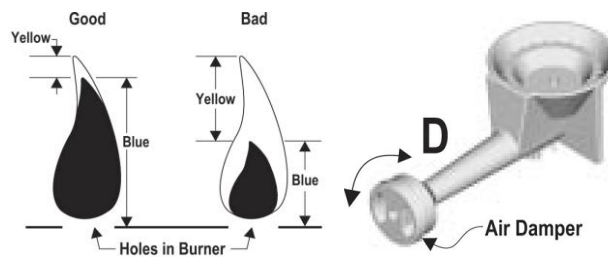

of your burner helps to control the amount of primary air that mixes with the LP gas. A blue flame with little or no yellow flame provides the best heat. Adjust the air damper by turning it clockwise or counterclockwise until the desired flame is achieved.



### Turning LP Cooker Off

- Turn all knobs to OFF position, Turn LP tank OFF by turning hand-wheel clockwise to a full stop.

### Hose Check

- Before each use, check to see if there is evidence of abrasion, wear, cuts or leaks, the hose must be replaced prior to the appliance being put into operation. The replacement hose assembly shall be that specified by the manufacturer.
- Cleaning and inspection of pressure regulator and hose assembly prior to use.

## Cleaning the Burner

	<b>CAUTION</b>	
<p>Checking and cleaning burner / venture tubes for insect nests. A clogged tube can lead to fire beneath the appliances.</p> <p>Spiders' nests or wasps' mud inside the burner may cause fire at the air damper. If a fire occurs, immediately turn off gas supply at LP tank valve. (See representative illustration in Fig.1)</p>		

### Note:

Spiders and small insects can spin webs and build nests inside the burner. This especially occurs in late summer and fall before frost when spiders are most active. These nests can obstruct gas flow and cause a fire in and around the burner and orifice. Such a fire can cause operator injury and serious damage to the appliance.

To help prevent a blockage and ensure full heat output, clean and inspect burner tube often (once or twice a month). NOTE: Water or air pressure will not normally clear a spider web.

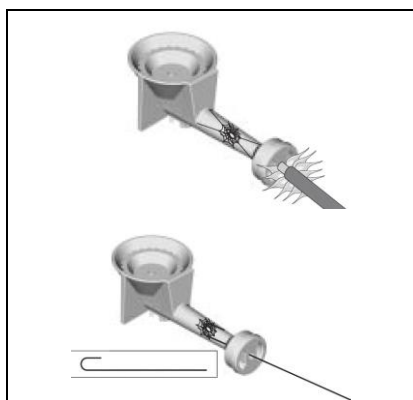

### Steps for Cleaning the Burner:

1. Remove orifice/hose from the burner.
2. Look inside the burner tube for nests, webs, or mud.
3. To remove the above obstructions, use an accessory flexible venture brush or bend a small hook on one end of a long flexible wire such as the one shown in Fig.2.
4. Inspect and clean the burner if needed.
5. Reattach orifice/hose to burner.



### Cleaning and Maintenance

- Keep appliance area clear and free from combustible materials, gasoline and other flammable vapors and liquids.
- Do not block holes in bottom or sides of appliance.
- Check burner flames regularly.
- Use appliance only in well-ventilated space. NEVER use in enclosed space such as carport, garage, porch, covered patio, or under ANY overhead construction.
- Completely thaw meat and poultry prior to placing in hot oil.
- To minimize splattering, dry surfaces of meat and poultry prior to placing in hot oil.
- When LP tanks is connected to appliance, store outdoors in well-ventilated space and out of reach of children.
- Store appliance indoors ONLY if LP tanks turned off and disconnected, removed from appliance and stored outdoors.
- To keep the appliance clear and free from gasoline and other flammable vapors and liquids.
- Not obstructing the flow of combustion and ventilation air.
- Keeping the ventilation opening(s) of the cylinder enclosed free and clear from debris.

	<b>CAUTION</b>	
<p>All cleaning and maintenance should only be done when the appliance is cool and with the fuel supply turned off at the LP tank. DO NOT clean any part in a self-cleaning oven. The extreme heat will damage the finish.</p>		

Correct care and maintenance will keep your appliance operating smoothly. Clean regularly as determined by the amount of use. NOTE: Clean the entire appliance each year and tighten all hardware on a regular basis (1-2 times a year or more depending on usage). Cleaning should be done where detergents won't harm patio, lawn or the like.

### Suggested Cleaning Materials:

- |                                      |                             |
|--------------------------------------|-----------------------------|
| ● Mild dish washing liquid detergent | ● Hot water                 |
| ● Wire brush                         | ● Paper clip                |
| ● Nylon cleaning pad                 | ● Soft brass bristled brush |

### Component Cleaning:

Burner: Wire brush loose corrosion from burner exterior. Clean clogged gas port holes with an opened paper clip. Replace corroded or damaged burners that would emit excess gas. Cooking surfaces, pots and pans: Clean the cooking surface with soapy water and a nylon cleaning pad.

## Part List

Number	Description
1	Steel Stand x 1pc
2	Burner x 1pc
3	Regulator x 1pc
4	Fish Pot x 1pc
5	Fish Basket x 2pcs
6	Fish Basket Handle x 2pcs
7	5" Thermometer x 1pc

## Assembly Procedure

1. Insert the burner into the steel stand and through the cut-out opening in the side of the stand.

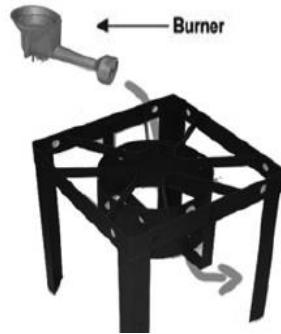

2. Insert the threaded pin on the bottom of the burner into the center hole in the burner bracket. Make sure the alignment pin is seated in the notch on the edge of the burner bracket. Aligned with the burner pins, and secure with the nut (on the threaded pin).

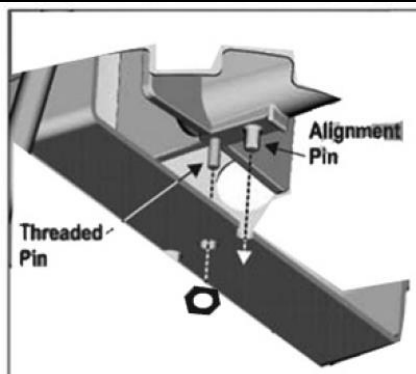

3. Insert the regulator hose assembly into the burner and tighten. Be sure not to strip threads on brass fitting. DO NOT OVERTIGHTEN. Proper connection is critical for correct operation of unit.



4. Attach the handle by inserting 4 bolts through basket, 4 locking washers and 4 nuts.

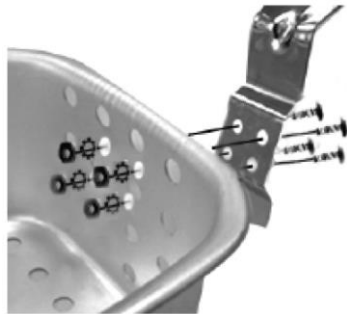

5. Attach the hook to the regulator.

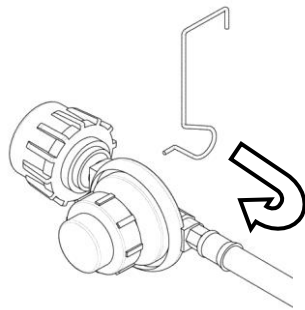

6. When transporting or storing the cooker without LP tank attached, hook the regulator onto cooker stand to prevent damage to regulator.



### Using Your Thermometer

Check the thermometer before each use by inserting into a pot of boiling water and ensuring that it registers approximately 212°F +/- 20°F (100°C +/- 10°C). If it does not function properly, obtain a replacement thermometer specified by the manufacturer before using the appliance.

Prior to lighting, position thermometer clip so that at least 2 3/4" (7 cm) of thermometer tip is submerged in oil. Reposition thermometer as necessary to cook. Continue to use thermometer until burner is turned off.

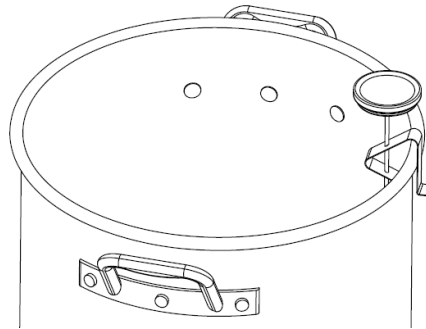

## LIMITED WARRANTY

1. Manufacturer warrants this Product to be free from defects in workmanship and materials for a period of Ninety (90) days from the date of purchase, PROVIDED claims are submitted, in writing, with proof of purchase.
2. If any part of this item fails because of a manufacturing defect within the Limited Warranty Period, Manufacturer offers to replace such part(s) provide that such parts have not been improperly repaired, altered, or tampered with or subject to misuse, abuse or exposed to corrosive conditions. This Limited Warranty is, however, subject to certain limitations, exclusions, time limits and exceptions (Hereinafter "Conditions") as listed below. Read these Conditions carefully.
3. This Limited Warranty shall be limited to the replacement or repair of any part(s) which Manufacturer determines, after reasonable examination, to have been defective at the time of manufacturing and manufacturer's obligation(s) shall be limited to replacement, if any, of defective part(s) which shall be shipped at Original Purchaser's expense to Original Purchaser's designated shipping address.
4. This Limited Warranty is given to and covers the **ORIGINAL PURCHASER ONLY** and such coverage terminates Ninety (90) days from the date of purchase.
5. **DAMAGE LIMITATION WARNING:** IN NO EVENT SHALL MANUFACTURER BE LIABLE FOR ANY INCIDENTAL OR CONSEQUENTIAL DAMAGES, INCLUDING (BUT NOT LIMITED TO) LOSS OF USE OF THE PRODUCT, LOSS OF TIME, INCONVENIENCE, EXPENSES FOR TRAVEL, TRANSPORTATION LODGING EXPENSES, LOSS BY DAMAGE TO PERSONAL PROPERTY OR LOSS OF INCOME, PROFITS OR REVENUE.
6. **MANUFACTURER'S OBLIGATION:** Manufacturer's liability shall be limited to the delivery of a good, merchantable Product and, if necessary, the repair or replacement, at manufacturer's option, of any defective part or unit.
7. **TRANSFER LIMITATIONS:** This Limited Warranty is not assignable or transferable. It covers only the original purchaser.
8. **RESERVED RIGHT TO CHANGE:** Manufacturer reserves the right to make changes or improvements to products it produces in the future without imposing on itself any obligations to install the same improvements in the products it has previously manufactured.
9. This Limited Warranty gives the Original Purchaser specific legal rights but there may be other rights which vary by jurisdiction.
10. This warranty does not cover the following items:
  - Chips or scratches on porcelain or painted surfaces.
  - Rust or corrosion is not deemed a manufacturing or materials defect.
  - Discoloration or loss of paint due to handling during assembly, heat or cleaning products. Paint may require touch up.
  - Stainless steel discoloration or corrosion.
  - Consumables such as batteries.

**IF CUSTOMER SERVICE BECOME NECESSARY:**

1. The Original Purchaser is responsible for shipping and handling charges of the returned item(s) and replacement parts, if any.
2. All parts to be replaced will need to be shipped before replacement items will be sent.
3. Follow the Customer Service Representative's instructions exactly. If a return is necessary, it must be packed carefully and shipped prepaid.

**Should you encounter any problems,  
CONTACT US FIRST  
DO NOT return product to the store!**

**RANKAM (CHINA) MANUFACTURING COMPANY LIMITED  
18/F., New Lee Wah Centre,  
88 Tokwawan Road, Kowloon, Hong Kong**

**For assistance, contact customer service at  
[customerservice@rankam.com](mailto:customerservice@rankam.com)  
or at 1 – 888 – 837 – 1380, 8:00am – 5:00pm, Pacific Standard  
Time, Monday to Friday**

**Manufactured for Bass Pro Shops  
2500 E. Kearney  
Springfield, MO 65898**