

This Owner's Manual is provided and hosted by [Appliance Factory Parts](#).



Rankam TF4039-013182-ST Owner's Manual

[Shop genuine replacement parts for Rankam
TF4039-013182-ST](#)



[Find Your Rankam Grill Parts - Select From 123 Models](#)

----- Manual continues below -----

**30 QT Stainless Steel
Turkey Fryer Set**
Model # TF4039-013182-ST

For Outdoor Use Only



Assembly, Use and Care Manual

Tools required:

Phillips screwdriver / Adjustable wrench



Thank you for purchasing this outdoor cooking appliance.

- This instruction manual contains important information necessary for the proper assembly and safe use of the appliance.
- Read and follow all warnings and instructions before assembling and using the appliance.
- Follow all warnings and instructions when using the appliance.
- Keep this manual for future reference.



DANGER



If you smell gas:

1. Shut off gas to the appliance.
2. Extinguish any open flame.
3. If odor continues, keep away from the appliance and immediately call your fire department.

Failure to follow these instructions could result in fire or explosion which could cause property damage, personal injury or death.





DANGER



1. Never operate this appliance unattended.
2. Never operate this appliance within 10 ft (3.0 m) of any structure, combustible material or other gas cylinder.
3. Never operate this appliance within 25 ft (7.5 m) of any flammable liquid.
4. Do not fill cooking vessel beyond maximum fill-line.
5. Never allow oil or grease to get hotter than 400°F or 200°C. If the temperature exceeds 400°F (200°C) or if oil begins to smoke, immediately turn the burner or gas supply OFF.
6. Heated liquids remain at scalding temperatures long after the cooking process. Never touch cooking appliance until liquids have cooled to 115°F (45°C) or less.
7. If a fire should occur, keep away from the appliance and immediately call your fire department. Do not attempt to extinguish an oil or grease fire with water.

Failure to follow these instructions could result in fire, explosion or burn hazard which could cause property damage, personal injury or death.

	PROP 65 WARNING	
 WARNING: This product can expose you to chemicals including benzene, which is known to the State of California to cause cancer and birth defects or other reproductive harm. For more information go to www.P65Warnings.ca.gov .		

	WARNING	
This Appliance is not intended for commercial use.		

Safety Symbols

The symbols and boxes shown below explain what each heading means. Read and follow all of the messages found throughout the manual.

	DANGER	
Danger: Indicates an imminently hazardous situation which, if not avoided, will result in death or serious injury.		

	WARNING	
Warning: Indicates a potentially hazardous situation which, if not avoided, will result in death or serious injury.		

	CAUTION	
Caution: Indicates a potentially hazardous situation or unsafe practice which, if not avoided, may result in minor or moderate injury.		



WARNING



1. Never leave the appliance unattended. Keep children and pets away from the appliance at all times.
2. The use of alcohol, prescription or non-prescription drugs may impair the consumer's ability to properly assemble or safely operate the appliance.
3. This appliance is for **OUTDOOR USE ONLY**. **DO NOT** use in building, garage or any other enclosed area.
4. This appliance is not intended to be installed in or on a boat. This appliance is not intended to be installed in or on recreational vehicles.
5. This appliance is not intended for and should never be used as a heater.
6. When cooking, the fryer / boiler must be on a level, stable noncombustible surface in an area clear of combustible material. As asphalt surface (blacktop) may not be acceptable for this purpose.
7. Keep the fuel supply hose away from any heated surface.
8. When cooking with oil or grease, the thermometer provided **MUST** be used. Follow instructions in this manual for proper installation and use of the thermometer. If the thermometer supplied with this fryer has been lost or damaged. A replacement thermometer must be one specified by the appliance manufacturer.
9. If the temperature exceeds 400°F (200°C) or if oil begins to smoke, immediately turn the burner or gas supply **OFF** and wait for the temperature to decrease to less than 350°F (176°C) before relighting burner according to the manufacturer's instructions. If there is a lid (cover), do not remove the lid.
10. When cooking with oil or grease, have a type BC or ABC fire extinguisher readily available. In the event of an oil or grease fire do not attempt to extinguish with water. Immediately call the fire department. A Type BC or ABC fire extinguisher may, in some circumstances contain the fire.
11. Never overfill the cooking vessel with oil, grease or water. Follow instructions in this manual for establishing proper oil, grease or water levels.
12. Introduction of water or ice from any source into the oil/grease may cause overflow and severe burns from hot oil and water splatter. When frying with oil/grease, all food products **MUST** be completely thawed and towel dried before being immersed in the fryer.
13. Do not place empty cooking vessel on the appliance while in operation. Use caution when placing anything in cooking vessel while the appliance is in operation.
14. In the event of rain, snow, hail, sleet or other forms of precipitation while cooking with oil or grease, cover the cooking vessel immediately and turn off appliance burners and gas supply. Do not attempt to move the appliance or cooking vessel.
15. Do not move the appliance when in use. Allow the cooking vessel to cool to 115°F (45°C) before moving or storing.
16. Do not leave the appliance unattended, keep children and pets away from the appliance at all times.
17. Please wear gloves while assembling the fryer.



WARNING



Installation Safety Precautions.

- Use appliance only with LP (propane) gas and the regulator/ valve assembly supplied.
- Installation must conform with local codes or, in the absence of local codes, with the *National Fuel Gas Code, ANSI Z223.1/NFPA 54, Storage and Handling of Liquefied Petroleum Gases, ANSI/NFPA 58; or Natural Gas and Propane Installation Code, CSA B1 49.1*
- Do not operate this appliance ON or UNDER any overhead roof covering, as well on or under any awning, overhang, apartment or condominium balcony, or deck.
- This appliance shall be used only outdoors, and must not be used in a building, garage or any other enclosed area.
- Use appliance at least 10 ft. from any wall or surface. Maintain 10 ft clearance to objects that can catch fire or source of ignition such as pilot lights on water heaters, live electrical appliances, etc. Never use under balconies made of wood or ANY overhead construction.
- Apartment Dwellers: Check with management to learn the requirements and fire codes for using an LP Gas appliance at an apartment. If allowed, use outside on the ground floor with a ten (10) feet clearance from walls or rails.
- Before opening LP tank valve, check the coupling nut for tightness. When appliance is not in use, turn off control knob and LP tank valve.
- Never move appliance while in operation or still hot.
- If you notice grease or other hot material dripping from appliance onto valve, hose or regulator, turn off gas supply at once. Determine the cause, correct, clean and inspect valve, hose and regulator before continuing. Perform a leak test.
- The regulator may make a humming or whistling noise during operation. This will not affect safety or use of appliance.
- Clean and inspect the hose before each use of the appliance. If there is evidence of abrasion, wear, cuts or leaks, the hose must be replaced prior to the appliance being put into operation.

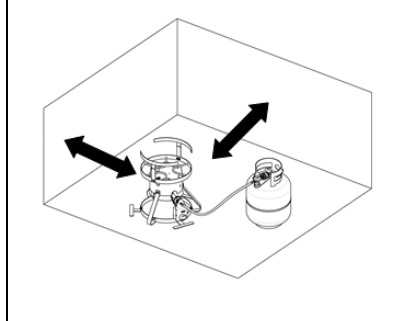



WARNING



- Never use a cooking vessel larger than 30 qts., diameter greater than 11-3/4 inches and taller than 15-1/2 inches.
- Never fill pot above upper fill line. Oil can splatter causing staining or discoloration to ground surface.
- Never place empty cooking vessel on the appliance while in operation. Use caution when placing anything in the cooking vessel while the appliance is in operation.
- Never move the appliance when in use. Allow the cooking vessel to cool before moving or storing.
- Never leave the appliance unattended. Keep children and pet away from the appliance at all times.
- This appliance is not intended for and should never be used as a heater.

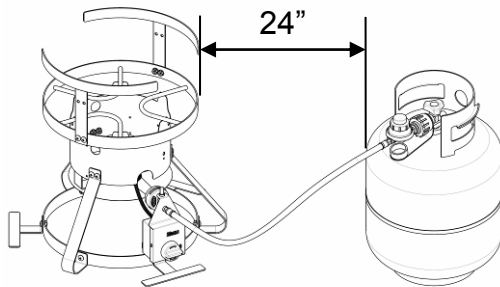

WARNING: Hose is a trip hazard.

Keep the fuel supply hose away from any heated surface

- Never operate appliance with LP tanks out of correct position specified in assembly instructions.
- Always close LP tank valve and remove coupling nut before moving LP tank from specified operating position.
- Appliance shall not be used for commercial cooking.
- This appliance will be hot during and after use. Use insulated oven mitts or gloves for protection from hot surfaces or splatter from cooking liquids.
- Avoid bumping of or impact with the appliance to prevent spillage or splashing of hot cooking liquid.
- Never drop food or accessories into hot cooking liquid. Lower food and accessories slowly into the cooking liquid in order to prevent splashing or overflow. When removing food from the appliance care should be taken to avoid burns from hot cooking liquids.



DANGER



- The safety relief valve on the LP tank could activate releasing gas and cause an intense fire with risk of death or serious injury. Therefore, follow instructions bulleted below exactly.
 - (a) Do not store a spare LP-gas cylinder under or near this appliance.
 - (b) Never fill the cylinder beyond 80 percent full; and
 - (c) If the instructions in (a) and (b) are not followed exactly, a fire causing death or serious injury may occur.
- If you see, smell, or hear escaping gas, immediately get away from the LP tank/appliance and call your fire department.
- All spare LP tanks must have safety caps installed on the LP tank outlet.

LP Tank Removal, Transport and Storage

- Turn OFF all control knobs and LP tank valve. Turn coupling nut counterclockwise by hand only – do not use tools to disconnect. Place dust cap on cylinder valve outlet whenever the cylinder is not in use. Only install the type of dust cap on the cylinder valve outlet that is provided with the cylinder valve. Other types of caps or plugs may result in leakage of propane.
- A disconnected LP tank in storage or being transported must have a safety cap installed (as shown). Do not store an LP tank in enclosed spaces such as a carport, garage, porch, covered patio or other building. Never leave an LP tank inside a vehicle which may become overheated by the sun.
- Do not store LP tanks in an area where children play.

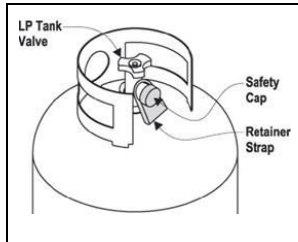

LP Tank

The LP tank used with your appliance must meet the following requirements:

- Purchase LP tanks only with these required measurements: 12" (30.5cm) (diameter) x 18" (45.7cm) (tall) with 20lb. (9kg) capacity maximum.
- The LP-gas supply cylinder to be used must be constructed and marked in accordance with the specifications for LP-gas cylinders of the US Department of Transportation (DOT) or the National Standard of Canada, CAN/CSA-B339, Cylinders, Spheres and Tubes for the Transportation of Dangerous Goods.

LP tank valve must have:

- Type 1 outlet compatible with regulator or appliance.
- Safety relief valve.
- UL listed Overfill Protection Device (OPD). This OPD safety feature is identified by a unique triangular hand wheel. Use only tanks equipped with this type of valve.
- LP tank must be arranged for vapor withdrawal and include collar to protect LP tank valve.



LP (Liquefied Petroleum Gas)

- LP gas is non toxic, odorless and colorless when produced. For your safety, LP gas has been an odor (similar to rotten cabbage) so that it can be smelled.
- LP gas is highly flammable and may ignite unexpectedly when mixed with air.

LP Tank Filling

- Use only licensed and experienced dealers.
- LP dealer must purge tanks before filling.
- Dealer should NEVER fill LP tank more than 80% of LP tank volume. Volume of propane in tanks will vary by temperature.
- A frosty regulator indicates gas overfill. Immediately close LP tank valve and call LP gas dealer for assistance.
- Do not release liquid propane (LP) gas into the atmosphere. This is a hazardous practice.
- To remove gas from LP tank, contact an LP dealer or call a local fire department for assistance. Check the telephone directory under "GAS Companies" for nearest certified LP dealers.

LP Tank Exchange

- Many retailers that sell appliances offer you the option of replacing your empty LP tanks through an exchange service, Use only those reputable exchange companies that inspect, precision fill, test and certify their cylinders. Exchange your tank only for an OPD safety feature-equipped tanks as described in the "LP Tank" section of this manual.
- Always keep new and exchanged LP tanks in upright position during use, transit or storage.
- Leak test new and exchanged LP tanks BEFORE connecting to appliance.

LP Tank Leak Test

For your safety

- Leak test must be repeated each time LP tank is exchanged or refilled.
- Do not smoke during leak test.
- Do not use an open flame to check for gas leaks.
- Appliance must be leak checked outdoors in well-ventilated area, away from open flames or sparks.

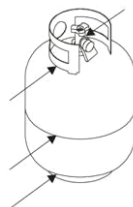

Use a clean paint brush and 50/50 soap and water solution.

Use mild soap and water. Do not use household cleaning agents. Damage to gas train components can result.

Brush soapy solution onto all weld seams and entire valve area.

	WARNING	
If "growing" bubbles appear, do not use or move the LP tank. Contact an LP gas supplier or your fire department.		

Connecting Regulator to the LP Tank

1. Place LP tank on a secure, level, and stable surface.
2. Turn control knob to the OFF position.
3. Turn LP tank OFF by turning hand wheel clockwise to a **full stop**.
4. Remove the protective cap from the LP tank valve. Always use cap and strap supplied with valve.

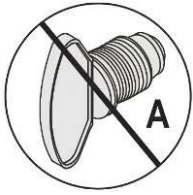

Do not use a POL transport plug (A) (plastic part with external threads)! It will defeat the safety feature of the valve.

5. Hold regulator, insert nipple (B) into LP tank valve. Hand tighten coupling nut, holding regulator in a straight line (C) with LP tank valve so as not to cross thread the connection.

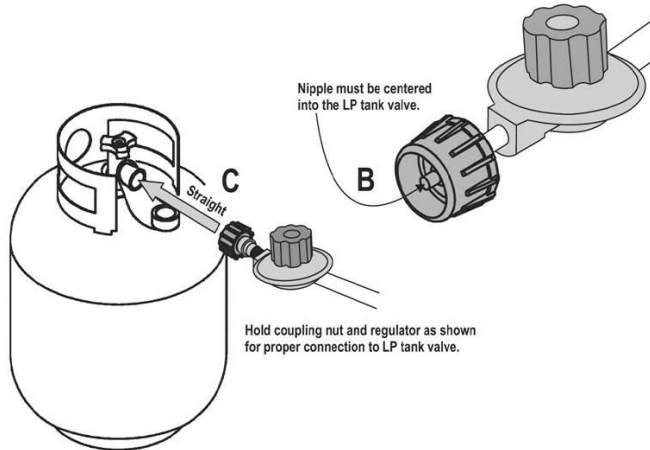

6. Turn the coupling nut clockwise to tighten to a full solid stop. The regulator will seal on the back-check feature in the LP tank valve, resulting in some resistance. An additional one-half to three quarters turn is required to complete connection. **Tighten by hand only – do not use tools.**

NOTE: If you cannot complete connection, disconnect regulator and repeat step 5 and 6. If you are still unable to complete the connection, **do not use this regulator!**

Disconnecting Regulator to the LP Tank

1. Turn control knob of regulator to the OFF position.
2. Turn LP tank OFF by turning hand wheel clockwise to a **full stop**.
3. Turn the coupling nut counterclockwise to loosen the connector. Loose by hand only – do not use tools.
4. When disconnected, the regulator should be hung on the hook attached to the appliance.



WARNING



- Do not insert any tool or foreign object into the valve outlet or safety relief valve. You may damage the valve and cause a leak. Leaking propane may result in explosion, fire, severe personal injury, or death.
- Never attempt to attach this appliance to the self-contained LP gas system of a camper or trailer or motor home.
- The pressure regulator and hose assembly supplied with the appliance must be used. Replacement pressure regulator and hose assemblies must be those specified by the appliance manufacturer.



WARNING



- Do not use appliance until leak checked.
- If leak is detected at any time, STOP.
- If you cannot stop a gas leak, immediately close LP tank valve, leave area of appliance, and call LP gas supplier or your fire department!

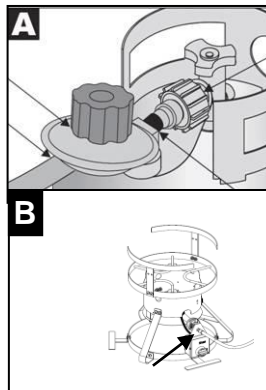

Leak Testing Valves, Hoses and Regulator

1. Turn all control knob(s) to OFF.
2. Be sure regulator is tightly connected to LP tanks.
3. Completely open LP tank valve by turning hand wheel counterclockwise. If you hear a rushing sound, turn gas off immediately. There is a major leak at the connection. Correct before proceeding.
4. Brush soapy solution onto indicated connections shown at right in A and B.
5. If "growing" bubbles appear, there is a leak. Close LP tank valve immediately and retighten connections. If leaks cannot be stopped, do not try to repair. Call for replacement parts. Order new parts by giving the serial number, model number and name of items needed to the Customer Service Center at 1-888-837-1380. Use only replacement parts specified by manufacturer.
6. Always close LP tank valve after performing tank leak test by turning hand wheel clockwise.

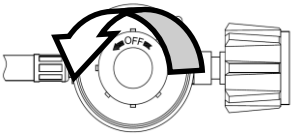

Lighting Instructions

Note: Do Not lean over LP cooker while lighting.

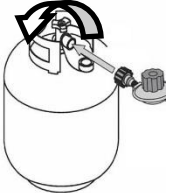
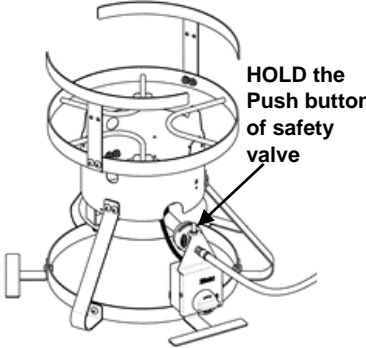
Step	Procedure	Illustration
1.	Read all instructions before lighting.	
2.	Turn regulator control valve to OFF position.	
3.	Fully turn timer control knob clockwise.	
4.	Fully open LP tank valve.	
5.	Light match and place it over burner. Tip: Wooden kitchen match works best.	
6.	PRESS and continually HOLD down push button of safety valve while slowly turning ON the regulator control valve. Continually hold down the push button of the safety valve. DO NOT stand with head or arms over cooker.	
7.	After burner is lit, continue to HOLD the push button for 10 seconds and then release. Holding push button of safety valve for less than 10 seconds will cause burner flame to go out.	

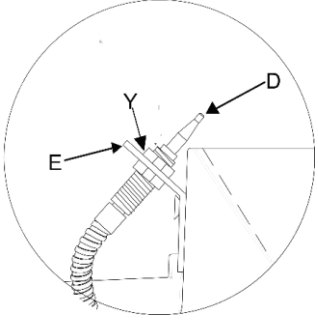
8.	If ignition does not occur in 5 seconds, turn the regulator and LP tank valve off, wait 5 minutes, and repeat the lighting procedure.	
9.	<p>Check the position of thermocouple, make sure the flame has full contact with the thermocouple.</p> <p>Note: If thermocouple does not have full contact with flame, unit will not stay lit.</p>	
10.	Cycle time for timer is around 15 minutes. If the timer is not reset within around 15 minutes, the burner will shut OFF automatically. If this occurs, please follow lighting instructions and continue to cook.	



CAUTION



If burner does not light OR if burner flame is accidentally extinguished, turn knob to OFF, wait 5 minutes, try again. If the burner does not ignite with valve open OR if burner flame is accidentally extinguished after lighting, gas will continue to flow out of the burner and could accidentally ignite with risk of injury.

Burner Flame Check

- Light burner, rotate knob from HIGH to LOW. You should see a smaller flame in LOW position than seen on HIGH. Always check flame prior to each use. The air damper (D) mounted on the back of your burner helps to control the amount of primary air that mixes with the LP gas. A blue flame with little or no yellow flame provides the best heat. Adjust the air damper by turning it clockwise or counterclockwise until the desired flame is achieved.

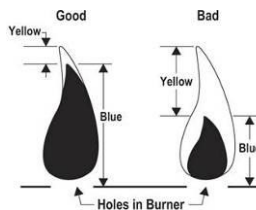

Turning LP Cooker Off

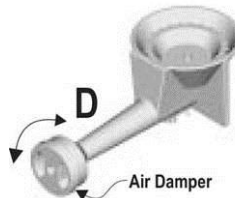

- Turn all knobs to OFF position, Turn LP tank OFF by turning hand-wheel clockwise to a full stop.



Hose Check

- Before each use, check to see if there is evidence of abrasion, wear, cuts or leaks, the hose must be replaced prior to the appliance being put into operation. The replacement hose assembly shall be that specified by the manufacturer.

Cleaning the Burner

	CAUTION	
<p>Checking and cleaning burner / venture tubes for insect nests. A clogged tube can lead to fire beneath the appliances. Spiders' nests or wasps' mud inside the burner may cause fire at the air damper. If a fire occurs, immediately turn off gas supply at LP tank valve.</p>		

Note:

Spiders and small insects can spin webs and build nests inside the burner. This especially occurs in late summer and fall before frost when spiders are most active. These nests can obstruct gas flow and cause a fire in and around the burner and orifice. Such a fire can cause operator injury and serious damage to the appliance.

To help prevent a blockage and ensure full heat output, clean and inspect burner tube often (once or twice a month). NOTE: Water or air pressure will not normally clear a spider web.

Steps for Cleaning the Burner:

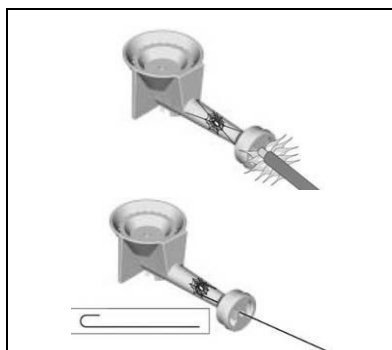

1. Remove orifice/hose from the burner.
2. Look inside the burner tube for nests, webs, or mud.
3. To remove the above obstructions, use an accessory flexible venture brush or bend a small hook on one end of a long flexible wire such as the one in small picture.
4. Inspect and clean the burner if needed.
5. Reattach orifice/hose to burner.



Cleaning and Maintenance

- Keep appliance area clear and free from combustible materials, gasoline and other flammable vapors and liquids.
- Do not block holes in bottom or sides of appliance.
- Check burner flames regularly.
- Use appliance only in well-ventilated space. NEVER use in enclosed space such as carport, garage, porch, covered patio, or under ANY overhead construction.
- Completely thaw meat and poultry prior to placing in hot oil.
- To minimize splattering, dry surfaces of meat and poultry prior to placing in hot oil.
- When LP tanks is connected to appliance, store outdoors in well-ventilated space and out of reach of children.
- Store appliance indoors ONLY if LP tanks turned off and disconnected, removed from appliance and stored outdoors.
- To keep the appliance clear and free from gasoline and other flammable vapors and liquids.

- Not obstructing the flow of combustion and ventilation air.
- Keeping the ventilation opening(s) of the cylinder enclosed free and clear from debris.
- Clean all cooking surfaces of vessels, aluminum pots and pan with warm, soapy water and a nylon cleaning pad to avoid oxidation, corrosion and rusting.

	CAUTION	
<p>All cleaning and maintenance should only be done when the appliance is cool and with the fuel supply turned off at the LP tank. DO NOT clean any part in a self-cleaning oven. The extreme heat will damage the finish.</p>		

Correct care and maintenance will keep your appliance operating smoothly. Clean regularly as determined by the amount of use. NOTE: Clean the entire appliance each year and tighten all hardware on a regular basis (1-2 times a year or more depending on usage). Cleaning should be done where detergents won't harm patio, lawn or the like.

Suggested Cleaning Materials:

- | | |
|--------------------------------------|-----------------------------|
| ● Mild dish washing liquid detergent | ● Hot water |
| ● Wire brush | ● Paper clip |
| ● Nylon Cleaning pad | ● Soft brass bristled brush |







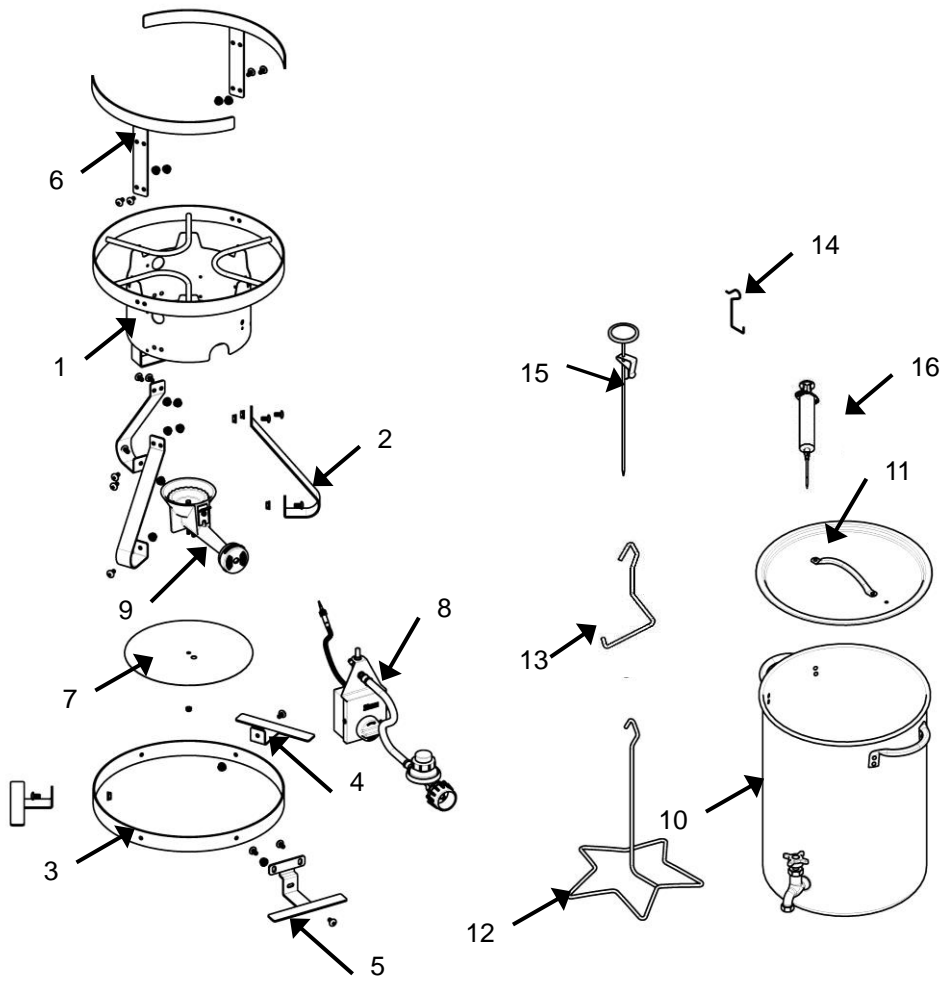



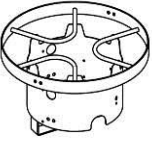

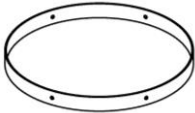
Component Cleaning:

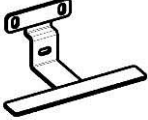
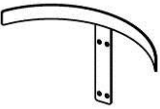
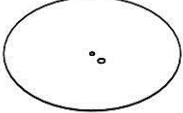
- Burner: Wire brush loose corrosion from burner exterior. Clean clogged gas port holes with an opened paper clip. Replace corroded or damaged burners that would emit excess gas.
- Cooking surfaces, pots and pans: Clean the cooking surface with soapy water and a nylon cleaning pad.

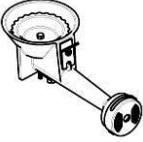

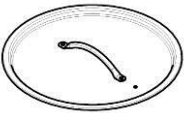
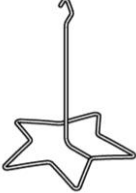
Product Diagram



Component List

<p>1. Welded Stand</p>  <p>1 pc</p>	<p>2. Legs</p>  <p>3 pcs</p>	<p>3. Stand Ring</p>  <p>1 pc</p>	<p>4. Small T-support Leg</p>  <p>2 pcs</p>
<p>5. Small T-support leg (with support bar for Timer)</p>  <p>1 pc</p>	<p>6. Adjustable Pot Tip Guard</p>  <p>2 pcs</p>	<p>7. Heat Shield</p>  <p>1 pc</p>	<p>8. Auto-shut off Valve, Timer Control Box, Gas Hose & Regulator Assembly</p>  <p>1 pc</p>
<p>9. Burner</p>  <p>1 pc</p>	<p>10. 30QT Turkey Pot</p>  <p>1 pc</p>	<p>11. Pot Lid</p>  <p>1 pc</p>	<p>12. Turkey Stand</p>  <p>1 pc</p>
<p>13. Turkey Hook</p>  <p>1 pc</p>	<p>14. Regulator Hook</p>  <p>1 pc</p>	<p>15. Thermometer</p>  <p>1 pc</p>	<p>16. Injector</p>  <p>1 pc</p>

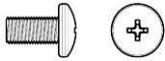
Hardware List

Item No.	Item Name	Diagram	Qty
A	BOLT M6 x 12		18
B	NUT M6 FLANGE LOCK		16

Assembly Instructions:

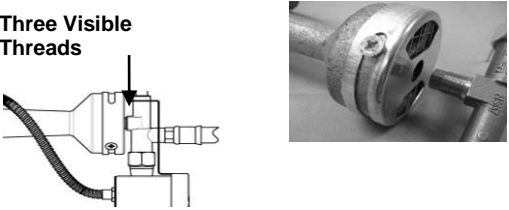
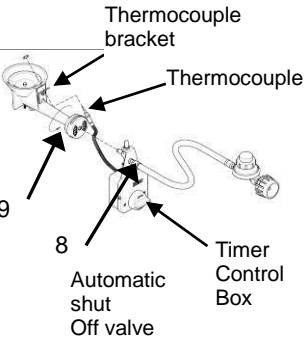
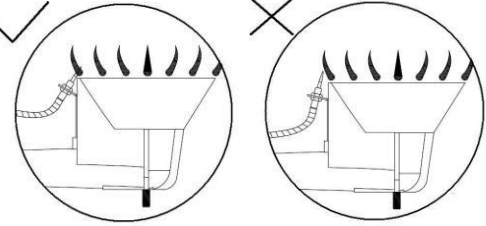
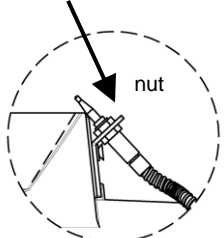
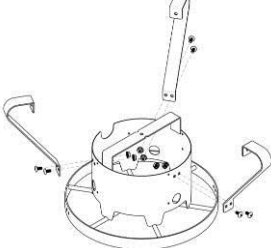
<p>1. Attach burner (9) to automatic shut off valve in the timer control box (8) by turning the burner clockwise. Do not fully tighten burner to the valve, tighten until 3 threads remain visible on the valve. Attach thermocouple to thermocouple bracket which has been fixed to the burner.</p> <p>Three Visible Threads</p>  <p>Proper connection is critical for correct operation of unit</p>	
<p>2. Attach thermocouple (9) as shown on the right illustration and tighten the nut.</p> 	<p>Leave 2 visible thread</p> 
<p>3. Assemble the legs (2) to welded stand (1) by using M6x12 bolts (A) and M6 nuts (B).</p>	

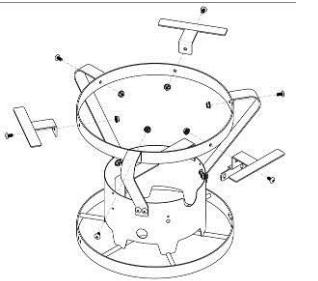
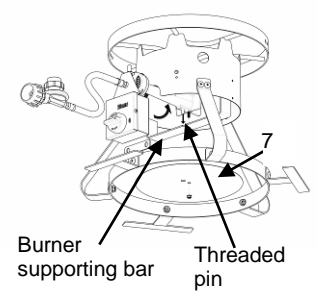
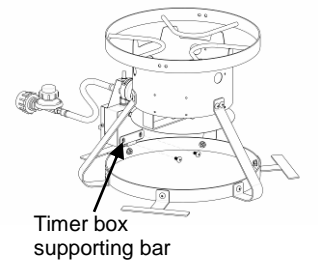
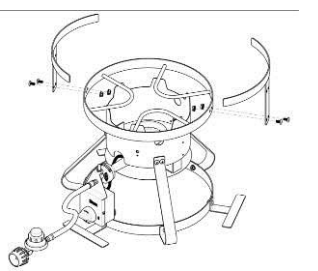
<p>4. Assemble the legs (2) to stand ring (3) by using M6x12 bolts (A) and M6 nuts (B). Install the small T-support legs (4) and (5) onto the stand ring (3) with M6x12 bolts (A) and M6 nuts (B).</p>	
<p>5. Unscrew the pre-assembled nut from the threaded pin of the burner (9). Then insert the threaded pin at the bottom of burner into the center hole of burner supporting bar. Make sure the alignment pin on the burner seat in the notch on the edge of burner supporting bar. Align the holes on heat shield (7) with threaded pin and alignment pin of burner (9) and hole on burner supporting bar, then fix the heat shield (7) outside the burner supporting bar and tighten with hex nut (on the threaded pin) onto the bolt of burner (9).</p>	
<p>6. Align timer control box (8) to the timer box supporting bar on small T-support leg (5) and fix it with M6x12 bolts (A) by going through the supporting bar and then to the timer box.</p>	
<p>7. Mount the adjustable pot tip guard (6) on to welded stand (1) by M6x12 bolts (A) and M6 nuts (B).</p>	

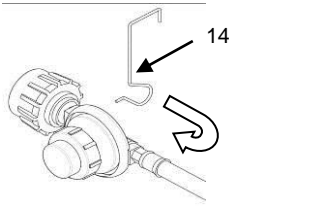
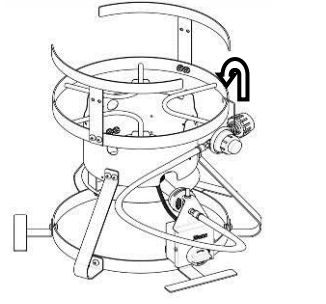
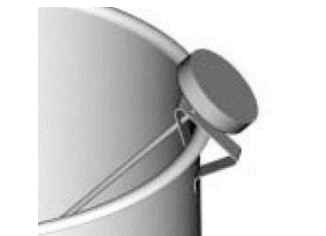
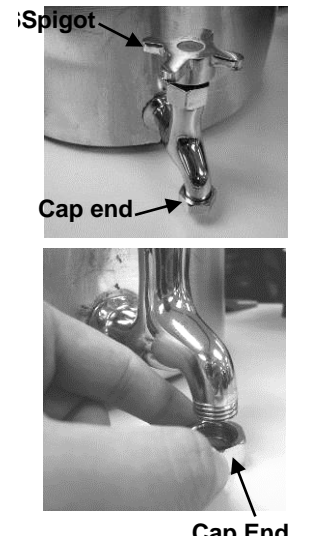
<p>8. Thread regulator hook (14) through hole on side of regulator.</p>	
<p>9. When transporting or storing LP cooker without tank attached, hook regulator onto burner or cooker stand to prevent damage to regulator.</p>	
<p>Using Your Thermometer Check the thermometer before each use by inserting into a pot of boiling water and ensuring that it registers approximately 212°F +/- 20°F (100°C +/- 10°C). If it does not function properly, obtain a replacement thermometer specified by the manufacturer before using the appliance. Prior to lighting, position thermometer clip so that at least 2.75" of thermometer tip is submerged in oil. Reposition thermometer as necessary to cook. Continue to use thermometer until burner is turned off.</p>	
<p>Using Your Vessel The vessel is equipped with a spigot which allows oil / water removing from the vessel.</p> <p>Following is the procedure of using spigot properly:</p> <ol style="list-style-type: none"> 1. Make sure the Spigot and Cap End are fully closed before cooking. 2. After cooking, wait for vessel is cool down fully. Don't touch the spigot during cooking or the while vessel is hot. 3. Unscrew the Cap End. 4. Turn counter-clockwise to "OPEN" the spigot. 5. The oil / water will flow out through the spigot. 6. After vessel cleaning, the Cap End must be tightly screwed and turned clockwise to "Close" the spigot. 	



DANGER



The Spigot and End Cap must be fully closed during cooking.
Never touch or attempt to open the spigot if the vessel is hot.

CAUTION DO NOT DISASSEMBLE OR REMOVE SPIGOT. To do so may result in leakage of fluid (oil or water) which may result in property damage or minor to severe injury.

The following safety measures are recommended when using your fry set.

LOCATION MATTERS

Select a safe place to fry your turkey. It should be in an open area, outside, and on a cement or brick surface. Place the liquid propane gas tank and fryer so that any wind blows the heat of the fryer away from the gas tank. Never use your fryer in an enclosed area, near a wall or on a wooden deck. Keep a minimum clearance of 10 feet from the sides, front and back of the fryer to any construction.

PREPARE PROPERLY

- Remove and discard any thermometer buttons, leg holders and giblet packs contained inside the completely thawed turkey. Do not attempt to fry a frozen or partially frozen turkey. Ensure your turkey is completely thawed prior to proceeding. NOTES: Bass Pro turkey fryer can cook a turkey weight up to 18 pounds. The USDA recommends thawing 24 hours (1 day) for every 4-5 pounds in refrigerator.
- Insert the T-Star stand up through the cavity of turkey so that the legs are at the top.



Determining the maximum fill level when using a vessel without a maximum fill line:

- Place the turkey (or other food product) on the lifter.
- Place the turkey and lifter into the empty vessel.
- Fill the vessel with water just until the turkey is completely submerged. There must be a minimum of 3 inches or 8 cm between the water level and top of the vessel.
- Remove the turkey from the pot and either mark the water level on the side of the vessel or measure the amount of water in the vessel.
- Remove the water and completely dry the vessel and the turkey.
- This is the amount of cotton seed oil, peanut oil or other cooking oil the vessel is to be filled with to cook the turkey.
- Use marinade by injecting it into the thicker areas of the turkey breasts and thighs.
- To use, load the injector with marinade and insert the needle into the turkey. Withdraw the needle slowly while pushing the plunger, minimizing large pockets of marinade and spreading it more evenly. Discard any unused marinade.
- Completely pat dry the inside and outside surfaces of the turkey. This is very important as it reduces the splattering of oil. After patting the bird dry, add herb rubs or seasonings to the skin.

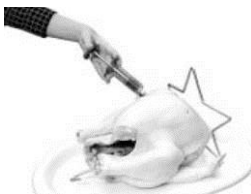
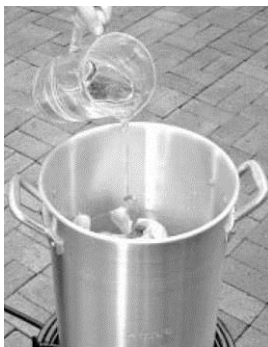





FRY WITH CARE

- Check your hose at both ends for proper connection. Also, place the tank and hose so that they are not located directly next to the fryer (see photo). Center the pot over the burner on the cooker.
- Fill the pot to the mark with cotton seed oil, peanut oil or other cooking oi. Remove the butcher's tape from the pot.



- Light the burner unit and heat the oil to 325°F. Never leave the fryer unattended at any time.
- Check the oil using a deep fry temperature gauge. If it has reached 325°F, you are ready to start deep frying. Monitor the temperature throughout the frying process to maintain 325°F – never let the oil temperature get hotter than 325°F.
- If the oil exceeds 400°F or if the oil begins to smoke, immediately turn the burner off.
- Wear long, insulated, flame-retardant gloves to protect your hands and arms. Use the lift handle to slowly lower the turkey into the oil. Pause at several points before reaching the bottom of the pot.
- Never drop food or accessories into hot cooking liquid. Lower food and accessories slowly into the cooking liquid in order to prevent splashing or overflow. When removing food from the appliance, care shall be taken to avoid burns from hot cooking liquids.
- Adjust the burner to maintain 325°F. Monitor the fryer during the entire process to assure a safe frying experience. Do not leave fryer unattended.
- Cook until a golden brown color is achieved. Normal cooking time is 3 1/2 minutes per pound.



	DANGER	
<ul style="list-style-type: none"> ● Do not fill past the maximum fill line marked on the utensil. ● An oil overflow may occur resulting in a fire which could cause property damage, personal injury or death. Follow directions above to prevent this. 		
	WARNING	
<p>Avoid bumping of or impact with the appliance to prevent spillage or splashing of hot cooking liquid. Introduction of water or ice from any source into the oil/grease may cause overflow and serve burns from hot oil and water splatter. When frying with oil/grease, all food products MUST be completely thawed and towel dried before being immersed in the fryer.</p>		

- Remove the turkey from the oil and place it on paper towels in an aluminum pan.
- Using a meat thermometer, check for an internal meat temperature of 180°F.
- Remove turkey fry accessory and allow the turkey to “rest” for 15 minutes to allow the juices to settle into the turkey. Slice and serve!

Trouble Shooting

PROBLEM	POSSIBLE CAUSE	CORRECTIVE ACTION
The burner does not light up.	The connection between the regulator and LP Tank are not in good condition.	Check and make sure the regulator coupling nut is tightened to the LP tank valve.
	The LP tank valve and regulator control valve do not open.	The regulator control valve and LP tank valve is open during normal operation. The regulator control valve is opened in clockwise direction and the LP tank valve is opened in counter-clockwise direction.
	The LP tank is empty.	Check and make sure the LP tank is filled with fuel.
	Push button of safety valve was not pushed down.	Press and fully hold down push button of safety valve after the lighted match is placed on the burner.
The burner does not stay lit.	The push button on safety valve was not fully pushed down for at least 10 seconds.	Fully hold down the push button on safety valve at least 10 seconds and then release.
	Timer is not activated.	Fully turn the timer control knob clockwise.
	The thermocouple is not in direct flame path of burner.	Ensure the thermocouple is assembled in right position and the nut is tightened on the thermocouple. (See Assembly Instruction - step 2 for detail) Make sure the flame has full contact with the thermocouple.
	High wind condition.	If wind blows out flame, gas supply will be cut off. Move out of wind and restart.
	Timer has completed its cycle.	Each cycle of timer is 15 minutes, after 15 minutes, the burner will go off automatically. Please re-set the timer.

PROBLEM	POSSIBLE CAUSE	CORRECTIVE ACTION
The oil is not reaching desired temperature.	The food is not fully defrosted.	Do not attempt to fry a frozen or partially frozen turkey or food. Ensure the turkey or food is completely thawed prior to proceeding.
	The regulator control valve is not fully opened.	Fully open the regulator control valve. The regulator control valve is opened in clockwise direction and the LP tank valve is opened in counter-clockwise direction.
	Overfilled Protection Device (OPD) on tank has been tripped.	Overfilled Protection Device (OPD) has been activated. To reset, turn off regulator control valve and LP tank valve. Disconnect the regulator from the LP tank and wait one minute. Reconnect the regulator control valve to the LP tank valve and slowly open the LP tank valve until it is fully open.

LIMITED WARRANTY

1. Manufacturer warrants this Product to be free from defects in workmanship and materials for a period of Ninety (90) days from the date of purchase, PROVIDED claims are submitted, in writing, with proof of purchase.
2. If any part of this item fails because of a manufacturing defect within the Limited Warranty Period, Manufacturer offers to replace such part(s) provide that such parts have not been improperly repaired, altered, or tampered with or subject to misuse, abuse or exposed to corrosive conditions. This Limited Warranty is, however, subject to certain limitations, exclusions, time limits and exceptions (Hereinafter "Conditions") as listed below. Read these Conditions carefully.
3. This Limited Warranty shall be limited to the replacement or repair of any part(s) which Manufacturer determines, after reasonable examination, to have been defective at the time of manufacturing and manufacturer's obligation(s) shall be limited to replacement, if any, of defective part(s) which shall be shipped at Original Purchaser's expense to Original Purchaser's designated shipping address.
4. This Limited Warranty is given to and covers the **ORIGINAL PURCHASER ONLY** and such coverage terminates Ninety (90) days from the date of purchase.
5. **DAMAGE LIMITATION WARNING:** IN NO EVENT SHALL MANUFACTURER BE LIABLE FOR ANY INCIDENTAL OR CONSEQUENTIAL DAMAGES, INCLUDING (BUT NOT LIMITED TO) LOSS OF USE OF THE PRODUCT, LOSS OF TIME, INCONVENIENCE, EXPENSES FOR TRAVEL, TRANSPORTATION LODGING EXPENSES, LOSS BY DAMAGE TO PERSONAL PROPERTY OR LOSS OF INCOME, PROFITS OR REVENUE.
6. **MANUFACTURER'S OBLIGATION:** Manufacturer's liability shall be limited to the delivery of a good, merchantable Product and, if necessary, the repair or replacement, at manufacturer's option, of any defective part or unit.
7. **TRANSFER LIMITATIONS:** This Limited Warranty is not assignable or transferable. It covers only the original purchaser.
8. **RESERVED RIGHT TO CHANGE:** Manufacturer reserves the right to make changes or improvements to products it produces in the future without imposing on itself any obligations to install the same improvements in the products it has previously manufactured.
9. This Limited Warranty gives the Original Purchaser specific legal rights but there may be other rights which vary by jurisdiction.
10. This warranty does not cover the following items:
 - Chips or scratches on porcelain or painted surfaces.
 - Rust or corrosion is not deemed a manufacturing or materials defect.
 - Discoloration or loss of paint due to handling during assembly, heat or cleaning products. Paint may require touch up.
 - Stainless steel discoloration or corrosion.
 - Consumables such as batteries.

IF CUSTOMER SERVICE BECOME NECESSARY:

1. The Original Purchaser is responsible for shipping and handling charges of the returned item(s) and replacement parts, if any.
2. All parts to be replaced will need to be shipped before replacement items will be sent.
3. Follow the Customer Service Representative's instructions exactly. If a return is necessary, it must be packed carefully and shipped prepaid.

**Should you encounter any problems,
CONTACT US FIRST
DO NOT return product to the store!**

**RANKAM (CHINA) MANUFACTURING COMPANY LIMITED
18/F., New Lee Wah Centre,
88 Tokwawan Road, Kowloon, Hong Kong**

**For assistance, contact customer service at
customerservice@rankam.com
or at 1 – 888 – 837 – 1380, 8:00am – 5:00pm, Pacific Standard
Time, Monday to Friday**

**Manufactured for Bass Pro Shops
2500 E. Kearney
Springfield, MO 65898**

Trouble Lighting Your Fryer?



Scan the QR Code or Visit the Link below
to View a Helpful Video



<https://youtu.be/RIGiCWxv73U>



For additional information, please
contact our customer service at
(888) 837-1380, Mon to Fri, 8:00
a.m. – 5:00 p.m., Pacific
Standard Time or



customerservice@rankam.com