

This Owner's Manual is provided and hosted by [Appliance Factory Parts](#).



All-Pro KG1521b Owner's Manual

[Shop genuine replacement parts for All-Pro KG1521b](#)



[Find Your All-Pro Grill Parts - Select From 18 Models](#)

----- Manual continues below -----



CERAMIC KAMADO GRILLS & SMOKERS

MODELS:

KG1120	KG1520	KG1920
KG1140	KG1540	KG1940
KG1160	KG1560	KG1960
KG1121b	KG1521b	KG1921b
KG1141b	KG1541b	KG1941b
KG1161b	KG1561b	KG1961b

WARNING! THE INFORMATION IN THIS MANUAL MUST BE FOLLOWED EXACTLY, OR FIRE MAY RESULT CAUSING PROPERTY DAMAGE, PERSONAL INJURY OR LOSS OF LIFE.

FOR YOUR SAFETY! DO NOT STORE OR USE GASOLINE OR OTHER FLAMMABLE VAPORS OR LIQUIDS IN THE VICINITY OF THIS GRILL.

CAUTION: NEVER USE LIGHTER FLUID, GASOLINE, OR OTHER VOLATILES TO START YOUR CHARCOAL, SINCE IT IS DANGEROUS AND THEY LEAVE A RESIDUAL TASTE IN YOUR FOOD. USE UTMOST CARE WHEN ADDING CHARCOAL TO GRILL. DISPOSE OF COOLED ASHES BY PLACING THEM IN ALUMINUM FOIL, SOAKING WITH WATER AND DISCARDING IN A NON-COMBUSTIBLE CONTAINER.

DO NOT USE ON BOATS OR RECREATIONAL VEHICLES.

DO NOT USE YOUR KAMADO GRILL INDOORS OR IN AN ENCLOSED AREA. FOR OUTDOOR USE ONLY.

DO NOT MOVE YOUR KAMADO GRILL WHILE COOKING OR HOT ASHES ARE STILL IN THE GRILL.

DO NOT REMOVE YOUR KAMADO GRILL FROM THE CART OR APPROVED GRILL TABLE.

DO NOT PLACE YOUR KAMADO GRILL DIRECTLY ON A WOODEN DECK, TABLE OR OTHER

COMBUSTIBLE SURFACES. IT CAN DAMAGE THE SURFACE OR CAUSE A FIRE.

Installation Instructions and Operator's Manual

MADE IN CHINA

DO NOT DISCARD THIS MANUAL
CUSTOMER: PLEASE RETAIN THIS MANUAL FOR FUTURE USE

KAMADO GRILLS – SERIES



11" Inner Diameter Grill



15" Inner Diameter Grill



19" Inner Diameter Grill

****NOTE – Grill Cart is not included with grill – optional accessory
Cart with side shelves shown above.**

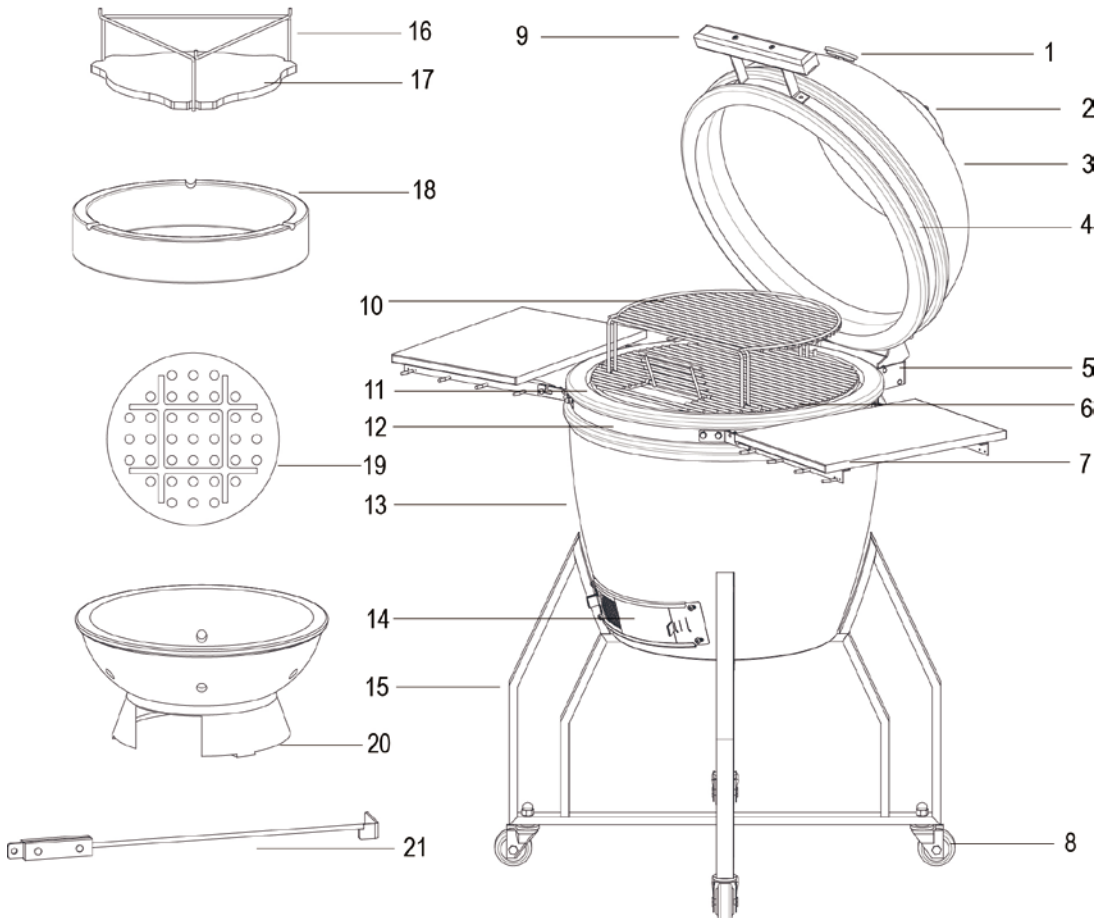

ITEM#	Part Name	Part Number			Materials	Grills/ Accessories
		11"	15"	19"		
1	Thermal Meter	GDCG-STM	GDCG-STM	GDCG-STM	Stainless Steel	Included
2	Top Vent	GDCG-S11TV	GDCG-S11TV	GDCG-S19TV	SUS 304	Included
3	Ceramic Dome	GDCG-S11CD	GDCG-S15CD	GDCG-S19CD	Ceramic	Included
4	Upper Band	GDCG-S11UB	GDCG-S15UB	GDCG-S19UB	SUS 304	Included
5	Hinge	GDCG-S11HS	GDCG-S15HS	GDCG-S19HS	SUS 304	Included
6	First Level Cooking Grid	GDCG-S11FCG	GDCG-S15FCG	GDCG-S19FCG	SUS 304	Included
7	Side Shelves	GDCG-S11SS	GDCG-S15SS	GDCG-S19SS	SUS 304 & Bamboo	Accessory w/cart
8	Casters	N/A	GDCG-CA GDCG-CB	GDCG-CA GDCG-CB	Galvanized Steel	Accessory w/cart
9	Handle	GDCG-S11HB	GDCG-S15HB	GDCG-S19HB	SUS 304 & Bamboo	Included
10	Secondary Cooking Grid	KGA1101	KGA1502	KGA1906	SUS 304	Accessory Item
11	Felt Gasket	GDCG-S11FG	GDCG-S15FG	GDCG-S19FG	Fibers	Included
12	Lower Band	GDCG-S11LB	GDCG-S15LB	GDCG-S19LB	SUS 304	Included
13	Ceramic Base	GDCG-S11CB	GDCG-S15CB	GDCG-S19CB	Ceramic	Included
14	Bottom Vent	GDCG-S11BV	GDCG-S11BV	GDCG-S19BV	SUS 304	Included
15	Cart	GDCG-S11C	GDCG-S15C	GDCG-S19C	SUS 304	Accessory Item
16	Cooking Grid Elevator	N/A	KGA1501	KGA1905	SUS 304	Accessory 15" & 19" Item
17	Heat Deflector	KGA1103	KGA1503	KGA1907	Ceramic	Accessory Item
18	Fire Ring	N/A	N/A	GDCG-S19FR	Ceramic	Included
19	Fire grate	GDCG-S11ICG	GDCG-S15ICG	GDCG-S19ICG	Steel	Included
20	Firebox	GDCG-S11FB	GDCG-S15FB	GDCG-S19FB	Ceramic	Included
21	Ash Cleaning Tool	KGA1102	KGA1505	KGA1909	SUS 304 & Bamboo	Accessory Item
	Pizza Stone	KGA1104	KGA1504	KGA1908	Ceramic	Accessory Item
	Teak Wood Table	N/A	N/A	KGA1901	Teak Wood	Accessory Item
	Grill Cover	KGA1109	KGA1510	KGA1911	Vinyl	Accessory Item
	Grill Table Cover	N/A	N/A	KGA1912	Vinyl	Accessory Item
	Ceramic Feet/Heat Shields (Yellow)	KGA1105	KGA1506	KGA1902	Ceramic/Stainless Steel	Accessory Item
	Ceramic Feet/Heat Shields (Red)	KGA1106	KGA1507	KGA1904	Ceramic/Stainless Steel	Accessory Item
	Ceramic Feet/Heat Shields (Green)	KGA1107	KGA1508	KGA1903	Ceramic/Stainless Steel	Accessory Item

ASSEMBLING YOUR KAMADO GRILL WITH OPTIONAL CART

IMPORTANT: Read all instructions and warnings carefully before installation and use. Failure to follow up these instructions may result in damages to the grill, injury to person, fire hazard, and will void the warranty.



FRAGILE! Keep the grill box upright and handle with care. Do not move the grill box around by dolly truck, and do not slide the box. Examine if the box is punctured or crushed when received.

Serial Number Record: It is important to record the serial number which is located on the lower portion of the hinge. Please write down on warranty card, and return the warranty card as instructed.

Assembly Tools Needed: Philips Screw Driver (Large), 5mm or 3/16 Allen Wrench (Included), 10mm wrench (Included)

STEP 1 Remove the plastic strips and remove the top and side panels of the shipping box. Please remove protective plastic film from the grill. Remove all components included in the box and the grill.

STEP 2 Assemble the optional cart. (The cart installation instruction sheet is included inside the box of the cart.) If no cart purchased, move to STEP 4.

STEP 3 Place assembled cart on a secure level surface with locking wheels facing forward before inserting the grill. Gently lift the grill and place it in the cart. Adjust the position so the front of the grill is centered between the legs with the two locking casters. The bottom vent should be easily accessible for use. (See Figure 1)

NOTE: IT IS HIGHLY RECOMMENDED THAT TWO PEOPLE LIFT THE GRILL INTO THE CART DUE TO THE WEIGHT OF THE WHOLE GRILL. DO NOT LIFT THE GRILL BY THE HINGE OR SIDE SHELF SUPPORT TABS.



Figure 1

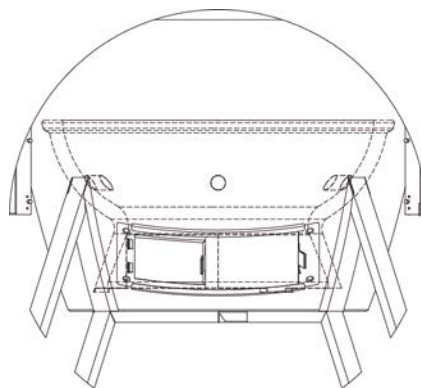

Figure 2

STEP 4 Open the grill and fully open the bottom vent door. Place the firebox inside the grill

and align the opening at the bottom of the firebox with the opening in the bottom vent door. This allows the air to flow into the grill and to remove ash with the included ash cleaning tool. (See Figure 2)

STEP 5 Place the round, black steel fire grate in the bottom of the firebox. The ash will fall through the holes in the fire grate and collect underneath the firebox. (See Figure 3)

STEP 6 Place the fire ring on top of the firebox with notches up. The notches are used to secure the legs of the Cooking Grid Elevator. (See Figure 4)

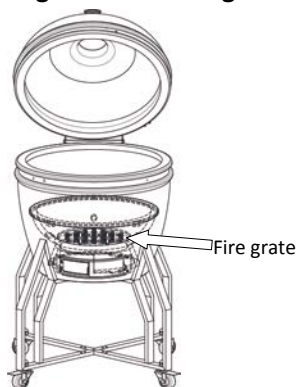

Figure 3

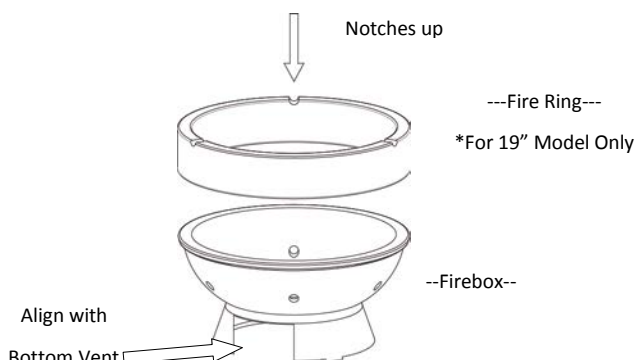

Figure 4

STEP 7 Place the 304 Stainless Steel first level cooking grid on top of the fire ring with the hinged accessing door in the front of the grill. (See Figure 5)

STEP 8 Close the grill dome and place the 304 stainless steel top vent on top of the dome neck. Turn the top vent base to make sure the post of the top vent is on the left side. This will prevent the dampers from sliding when the dome is opened. (See Figure 6)

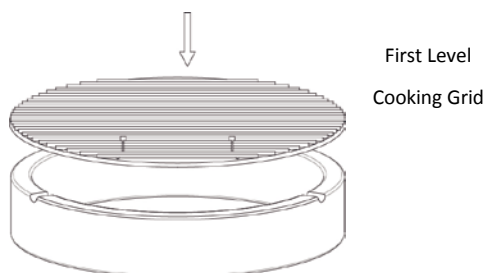

Figure 5

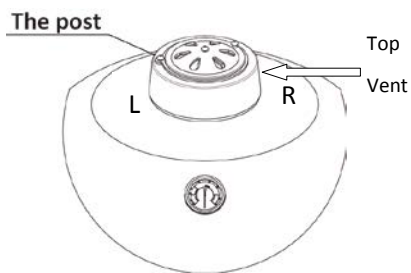

Figure 6

STEP 9A Install Front handle with top grill done in the closed position – be careful not to over tighten the nuts... (See Figure 7)

STEP 9B Attach the side shelves by placing the front pins in the slots of the shelf brackets that are installed on the grill. (See Figure 8) (Optional cart and side shelves purchased – if no cart and side shelves you are finished.)

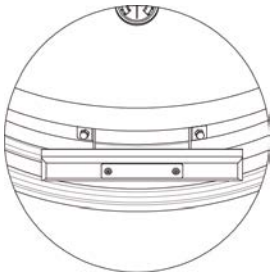

Figure 7

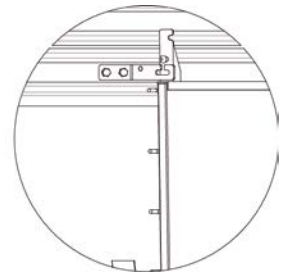
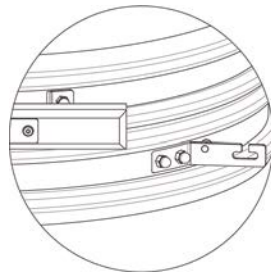

Figure 8

CONGRATULATIONS! YOU ARE READY TO USE THE KAMADO GRILL NOW!

ASSEMBLING YOUR KAMADO GRILL WITH OPTIONAL WOOD TABLE

STEP 1 Remove the plastic strips and remove the top and side panels of the shipping box. Please remove protective plastic film from the grill. Remove all components included in the box and the grill.

STEP 2 Assemble the wood grill table all except the two table top pieces. (The wood grill table installation instruction sheet is included inside the box of the table.) (See figure 9)

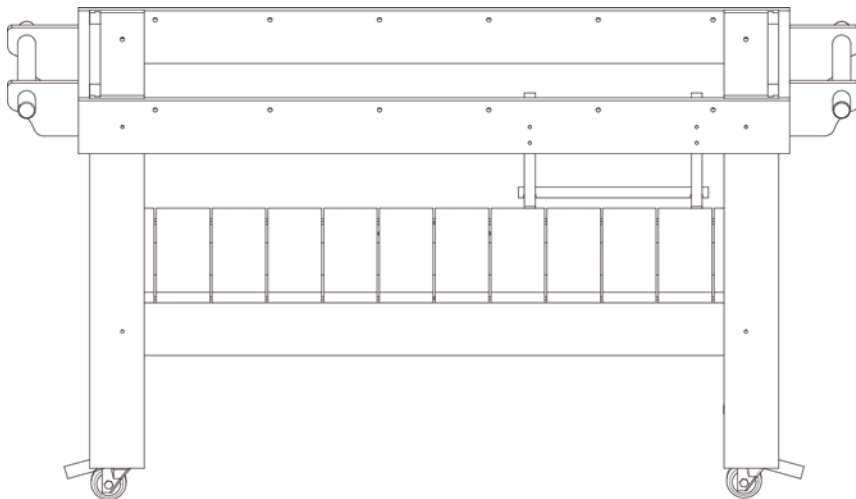

Figure 9

STEP 3 Place the three ceramic grill feet on the bottom shelf of the grill table to form a triangle \triangle with the top being the back of the grill table. The other two feet should be placed just to the left and right of the bottom vent door. Place the Heat Shield pan over the three ceramic grill feet. (See Figure 10)

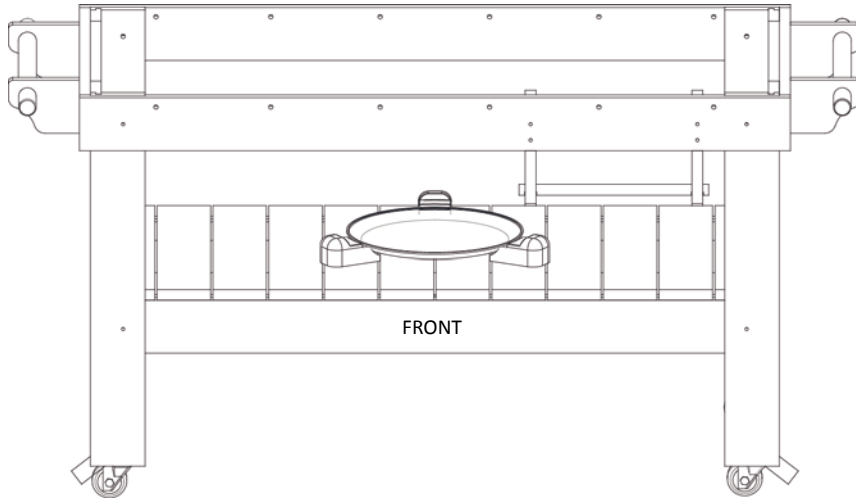

Figure 10

STEP 4 Place assembled table on a secure level surface and lock the front casters before inserting the grill. Gently place the grill into the table and adjust the feet with the Heat Shield pan to fit with the base of the grill. Adjust the position so the front of the grill is centered between legs with the two locking casters. (See Figure 11)

NOTE: IT IS HIGHLY RECOMMEND THAT TWO PEOPLE LIFT THE GRILL INTO THE CART DUE TO THE WEIGHT OF THE WHOLE GRILL. DO NOT LIFT THE GRILL BY THE HINGE OR SIDE SHELF SUPPORT TABS.

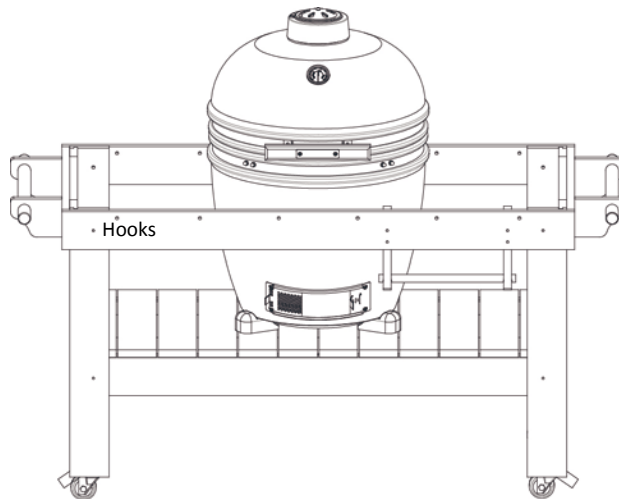

Figure 11

STEP 5 Attach the two top panels of the table. And secure the two tops to the top frame of the wood grill table by screws provided in the table package. (See Figure 12) The table top should fit just under the bottom ring of the grill.

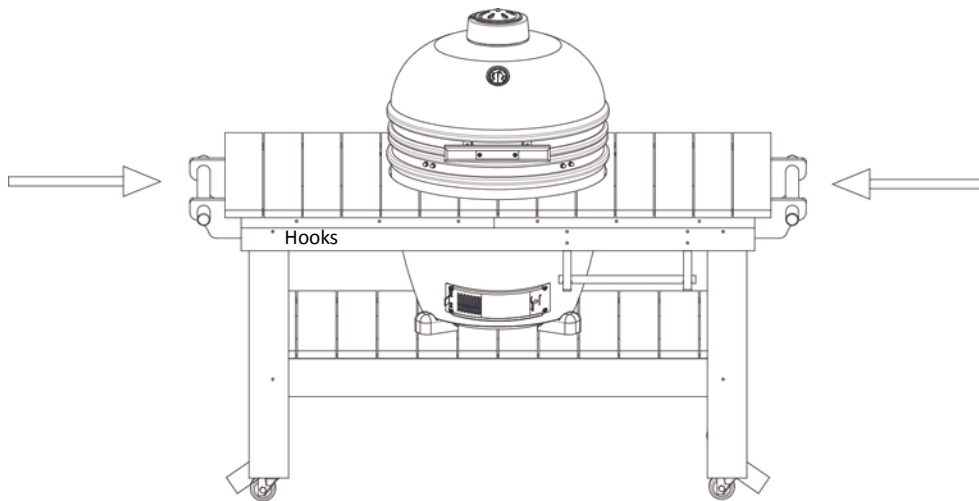

Figure 12

STEP 6 Follow STEPS 4 – 9 on Page 4 and 5 to finish the final assembly of the whole grill.

CONGRATULATIONS! YOU ARE READY TO USE THE KAMADO GRILL NOW!

STARTING/LIGHTING YOUR KAMADO GRILL

STEP 1 Kamado Grill is easy to start. Locate the fire grate inside the firebox as shown in Figure 13. Add enough charcoal that starts just below the holes in the wall of the fire box, with the peak of the mound just below the upper edge of the fire ring. (See Figure 13) Please follow important tips of adding charcoal as below.



Figure 13

IMPORTANT TIPS:

- A. Build the mound with larger chunks at the bottom, while leaving smaller ones on top as you build it. Do not dump charcoals directly into the firebox. Smaller pieces could block the air holes of the fire grate.
- B. Less charcoal should be added for initial lighting of the charcoal. After you get some charcoal lit, spread out the lit charcoal on the fire grate evenly, and add more charcoal as needed.
- C. Do not start the grill with too much charcoal, it will rapidly reach a high temperature, and it will take longer time to get the temperature down to your desired cooking temperature.
- D. Charcoal could be relit 2 or 3 times for multiple cooking. Use the ash tool to stir the used charcoal in order to make ashes drop down through the fire grate. Add 1/3 fresh charcoal to the used charcoal for building a new mound.
- E. A full firebox of ONLY fresh charcoal is highly recommended when smoking & searing to reach desired temperatures.

STEP 2 Open the bottom vent door and leave the dome open. Light the charcoal with a fire starter cube or two, chimney starter, electric starter or other method. Wait 8-10 minutes for the charcoal to build a small bed of ember. Then close the dome, and leave the top vent fully open.

CAUTIONS:

- A. **NEVER USE ANY LIGHTER LIQUID or any other combustible liquids to light up the charcoal.**
- B. **NEVER use "Instant Light" briquettes. The grill will cook the fuel flavor in your food.**
- C. **NEVER use briquette charcoal. This type of charcoal can not reach temperatures above 500°F and it does not offer true charcoal flavor.**
- D. **ALWAYS use protective gloves to operate the grill. The grill is hot during operation.**









COOKING TEMPERATURE ADJUSTMENT

To achieve a consistent cooking temperature as high as 750°F or as low as 225°F is easy on your Kamado Grill. Actually you can maintain low temperatures for up to 12 hours without adding any more natural lump charcoal.

OUR KAMADO GRILL COOKING TEMPERATURE IS TO BE CONTROLLED BY ADJUSTING THE TOP VENT AND BOTTOM VENT. INCREASING AIR FLOW THROUGH THE TOP AND BOTTOM VENT WILL ACHIEVE A HIGHER COOKING TEMPERATURE, WHILE DECREASING AIR FLOW THROUGH THE

TOP AND BOTTOM VENT WILL ACHIEVE A LOWER COOKING TEMPERATURE. THIS IS THE KEY TO ALL THE COOKING TECHNIQUES ON YOUR KAMADO GRILL.

CAUTION – If you are going to cook at a low & slow temperature, do not let the grill get too hot. It takes hours to get temperatures down. Just start the grill with as little charcoal as possible.

	TEMP	TOP VENT	BOTTOM VENT
SMOKING	150 - 275°F		
Baking Or ROASTING	275 – 350°F		
Grilling	350 - 500°F		
SEARING	500 - 750°F		

WARNING! PREVENT A “FLASHBACK”

If the dome is lifted suddenly after a period of time for cooking, a sudden surge of flame or heat called a “FLASHBACK” could occur. This is caused by the sudden exposure to oxygen.

To prevent a “FLASHBACK”, fully open both top and bottom vents and wait for 5 seconds, then lift up the dome about 1” for 2-3 seconds. After that, you could fully open the dome.

COOKING CONFIGURATIONS

COOKING CONFIGURATION: SMOKING or Roasting (see figure 14)

This configuration is for smoking meats and other foods requiring indirect heat. It is recommended to place a drip pan on the top of the heat deflector.

This configuration is also great for roasting chicken (with our without a Chicken Stand), turkey or

other foods requiring indirect heat. Higher cooking temperature is required for roasting by adjusting the top and bottom vent.

Accessories: HEAT DEFLECTOR

COOKING GRID ELEVATOR

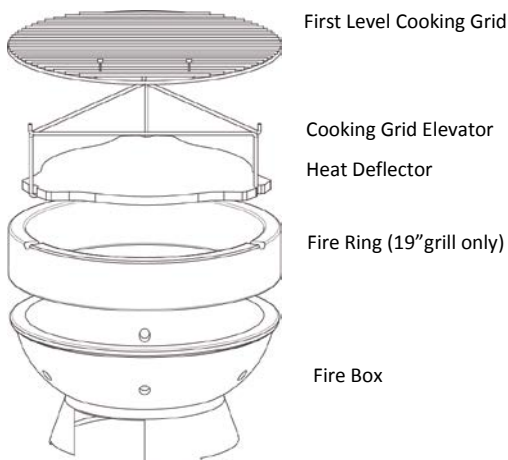

Figure 14

COOKING CONFIGURATION: BAKING (SEE FIGURE 15)

This configuration is for heating foods that are traditionally cooked in ceramic or metal containers like casseroles and hot appetizers. A pizza should not be baked directly on the heat deflector. The bottom crust will burn. This configuration is ideal for baking pizza, cookies or bread.

Accessories: HEAT DEFLECTOR

COOKING GRID ELEVATOR

PIZZA STONE

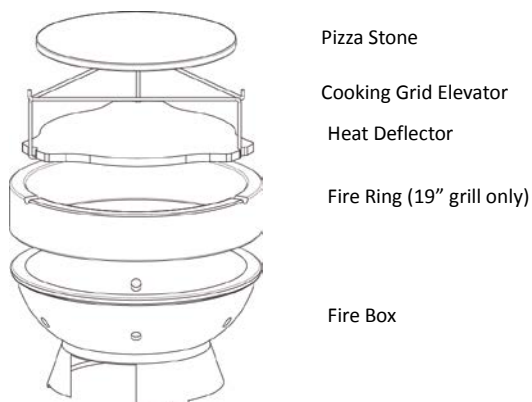

Figure 15

COOKING CONFIGURATION: Grilling or Searing (SEE FIGURE 16, 17)

This configuration is a standard way of grilling or searing on your Kamado Grill. This is great for steaks, hamburgers, chicken breasts or anything you want to cook directly over the 100% Natural Lump Charcoal.

If you are grilling various foods like sea food, fish or vegetables, The Cooking Grid Elevator and Heat Deflector can be used.

Accessories: COOKING GRID ELEVATOR (WITH OR WITHOUT)

FIRST LEVEL COOKING GRID

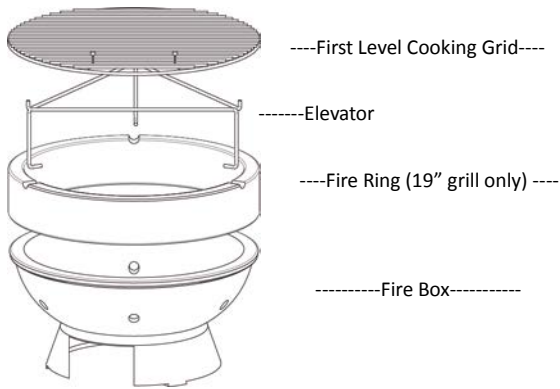

Figure 16



Figure 17

COOKING CONFIGURATION: SECONDARY COOKING GRID (SEE FIGURE 18)

This configuration is to add more cooking area to allow you to cook as many different foods as possible. When you position the Secondary Cooking Grid, please make sure the two legs on the front will not block the accessing door on the First Level Cooking Grid for adding fresh charcoals.

Accessories: COOKING GRID ELEVATOR

FIRST LEVEL COOKING GRID

SECONDARY COOKING GRID

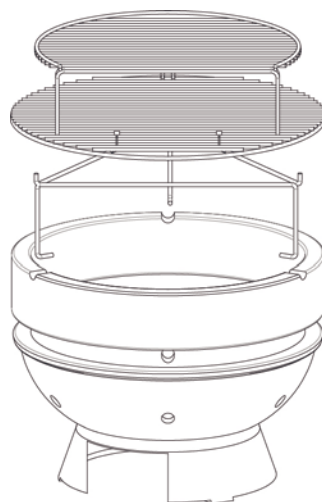

Secondary Cooking Grid

First Level Cooking Grid

Cooking Grid Elevator

Fire Ring (19" grill only)

Fire Box

Figure 18

CLEANING & MAINTENANCE

The Kamado Grill is made of quality materials, so there is not much general cleaning & maintenance. The best way to protect your Kamado Grill is to store a grill cover. (See Figure 19)

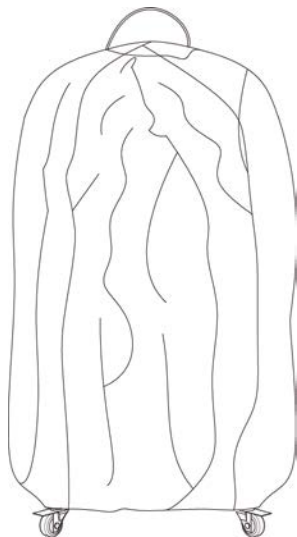

Figure 19

CLEANING ASHES FROM YOUR GRILL

Usually there is a need to remove the ashes underneath the firebox after cooking. An Ash Cleaning Tool is included in the Kamado Grill. Please follow the steps for removing ashes from a grill in a cart or a grill table.

CAUTION! Wait until the ashes and the ceramics are completely cool. Then removing ashes from your grill and properly disposing of.

STEPS

1. If there is any partially used charcoal in the firebox, stir the charcoal so any ash in the firebox will drop down.
2. Open the bottom vent door fully, and place a small container under the opening to catch the ash. It is recommended to have a little water in the ash container before you remove ashes into the container. Wind might blow away ashes.
3. Insert the Ash Cleaning Tool through the bottom vent door and pull out ashes into the ash container.

GRILL BANDS

Check position and tightness of both upper and lower bands, and also the hinge at the beginning of every grilling season or annually. If the bands & hinge are in proper position, use a 10mm wrench and Allen wrench (included in the grill package) to check the tightness of each band connectors, side shelves brackets connectors, and hinge connectors. If loose, please tighten all connectors fully. If a band is not centered, loosen the band enough to push it back in position. Then tighten the band connector with a 10mm wrench and Allen wrench.

CLEANING YOUR KAMADO GRILL

If your Kamado Grill is not used for a certain period of time, moisture can be trapped inside the grill and you might see mold or mildew on some parts like the cooking grids or internal ceramics. This can be easily cleaned, since Kamado Grills are self-cleaning, using the following steps.

CAUTION! Do not use bleach or other cleaning liquids or products. It will leave an unpleasant taste in food.

1. Add charcoal and light it. Allow the grill to heat to a higher temperature up to 600°F for 15 minutes with the dome closed.
2. Allow the grill to cool down completely with dome closed.
3. Before cooking, brush the cooking grids with a standard grill brush. You can also use a soft bristle brush to remove any residue on ceramics. **(Do not use any bristle brush to clean the outer side of the ceramics with glaze.)**

GASKET REPLACEMENT

The felt gasket material will degrade over time. Depending on the use of the grill, the exposed gasket material on the ceramic base and dome and the neck of the dome might need to be replaced every 1 or 2 years.

1. Use a box cutter to make a cross cut on the old gasket material. Pull off the loose material by hand as much as possible. (See Figure 20)
2. Use a paint scraper with enough pressure to scrape around the edges of the dome and base. Remove the remaining gasket material and adhesive as much as possible. Be careful not to press too hard or at a steep angle to avoid damage to the ceramic or glaze. (See Figure 21)

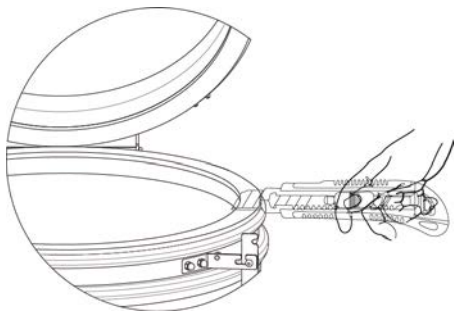

Figure 20

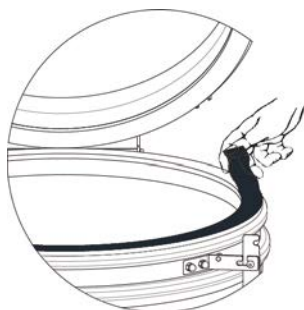

Figure 21

3. Clean edges of the dome and base with solvent.
4. Remove about 6" of the white backing material of the new felt gasket. Facing the grill, start the new gasket on the base dome at the center of the rear side near to the hinge. (See Figure 22) And ensure that the new gasket is flush to the interior of the base dome edge.

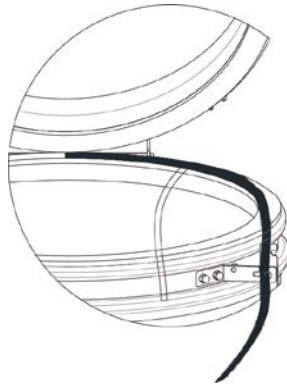

Figure 22

5. Use a box cutter to remove excess gasket material, so the ends meet flush and create a seamless gasket. (See Figure 23)
6. Follow same steps as above to replace the gasket on the neck of the dome. (See Figure 21)



Figure 23

CLEANING HEAT DEFLECTOR AND PIZZA STONE

Allow ceramic heat deflector and pizza stone to cool completely before cleaning and indoor storage. Just wipe off food material with a brush and store inside a dry place.

CAUTION!

- **DO NOT** place the hot ceramics on tables or surfaces that are not heat resistant.
- **DO NOT** use either ceramic plate to cook with on a stove top.
- **DO NOT** use cleaning chemicals or soap and water.
- **DO NOT** soak in water. It may cause it to crack during the next use.