

This Owner's Manual is provided and hosted by [Appliance Factory Parts](#).



# TRAEGER TFB78GZE Owner's Manual

[Shop genuine replacement parts for TRAEGER  
TFB78GZE](#)



[Find Your TRAEGER Grill Parts - Select From 139 Models](#)

----- Manual continues below -----



**TRAEGER**<sup>®</sup>  
WOOD FIRED GRILLS

# OWNER'S MANUAL



**A MAJOR CAUSE OF FIRES IS FAILURE TO MAINTAIN REQUIRED CLEARANCES (AIR SPACES) BETWEEN COMBUSTIBLE MATERIALS. IT IS OF UTMOST IMPORTANCE THAT THIS PRODUCT BE INSTALLED ONLY IN ACCORDANCE WITH THESE INSTRUCTIONS. IMPORTANT: RETAIN FOR FUTURE REFERENCE. READ CAREFULLY.**

**TFB78GZE/GLE/GZEC/GLEC  
TFB57GZE/GLE/GZEC/GLEC**

# IMPORTANT SAFETY

## READ ALL INSTRUCTIONS BEFORE INSTALLING AND USING THE APPLIANCE

Please read this entire manual before installation and use of this pellet-burning appliance. Failure to follow these instructions could result in property damage, bodily injury, or even death. Contact local building or fire officials about restrictions and installation inspection requirements in your area.

Cooking with a hardwood fire brings years of enjoyment – to you and your lucky friends and family. Your new Traeger grill is specially designed to make cooking easier while giving you optimal performance with the most savory-flavored food.

As with all grills and cooking appliances, any time you burn a material (whether it be wood, gas, or charcoal), organic gases are formed during the cooking process. One gas that can be particularly harmful in concentrated quantities is carbon monoxide. In an outdoor, open-air environment, carbon monoxide should naturally dissipate and not harm you.

**WARNING!** Follow these guidelines to prevent this colorless, odorless gas from poisoning you, your family, your pets, or others:

- Know the symptoms of carbon monoxide poisoning: headache, dizziness, weakness, nausea, vomiting, sleepiness, and confusion. Carbon monoxide reduces the blood's ability to carry oxygen. Low blood oxygen levels can result in loss of consciousness and death.
- See a doctor if you or others develop cold- or flu-like symptoms. Carbon monoxide poisoning, which can easily be mistaken for a cold or flu, is often detected too late.
- Alcohol consumption and drug use increase the effects of carbon monoxide poisoning.
- Carbon monoxide is especially toxic to mother and child during pregnancy, infants, the elderly, smokers, and people with blood or circulatory system problems, such as anemia or heart disease.
- Only use your Traeger grill outside on a noncombustible floor and away from combustible materials.
- Never use gasoline, gasoline-type lantern fuel, kerosene, charcoal lighter fluid, or flammable liquids to start or "freshen up" a fire in this appliance. Keep all such liquids well away from this appliance when in use.

### **IMPORTANT: READ CAREFULLY AND RETAIN FOR FUTURE REFERENCE.**

If you are assembling this unit for someone else, provide this manual for the owner to read and save for future reference.

#### **DANGER!**

##### **For North American Consumers:**

- Plug into an appropriate 3-prong outlet.
- An electrical supply with GFCI protection is required. To protect against shock hazard, locate a grounded 3-prong receptacle in reach of the 6' (1.8-m) power cord. When installing the receptacle, follow the National Electrical Code and local codes and ordinances.

##### **For Consumers in the European Union:**

- Plug into an appropriate earthed outlet.
- Do not remove earth prong or modify plug in any way. Do not use an adapter or extension cord.

#### **DANGER!**

- Hazardous voltage is present, which can shock, burn, or cause death. Disconnect the power cord before servicing the grill unless otherwise noted in this Owner's Manual.
- Never use or store flammable liquids near the grill.
- Never use gasoline or lighter fluid to manually light your grill.

## WARNING!

### Smoke Hazard

A pellet overflow condition can occur during start-up, resulting in unusually thick, white smoke that lasts a long time. If this occurs, power down your grill with the Main Power switch and unplug. If this condition continues long enough, gases can build up from partial ignition and fully ignite, causing the lid to “burp.” If this burp occurs and your grill has not been properly maintained as described in “Maintaining Your Grill” on pages 20-21, a grease fire could result. To remedy this condition, let the grill cool down completely, remove all internal components, and thoroughly clean all ash and pellets from the grill and firepot (see page 21, “Cleaning the Ash from Inside and Around the Firepot”).

## WARNING!

### Burn Hazard

Many parts of the grill will become very hot during operation. Care must be taken to avoid burns, both during operation and afterwards, while the grill is still hot.

- **Never** leave the grill unattended when young children are present.
- **Never** move the grill when it is operating.
- Let the grill cool thoroughly before moving or attempting to transport.

## WARNING!

### Fire Hazard

- When operating this grill, maintain a **MINIMUM** distance of 18 inches (45.7 cm) from the grill to combustibles.
- When operating this grill under overhead combustibles, a **MINIMUM** of 40 inches (102 cm) is required.

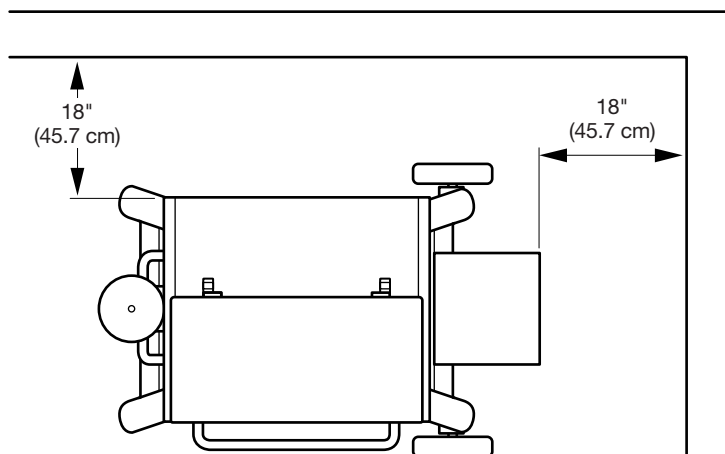

## WARNING!

### Air Contaminant Hazard

- Assemble and operate this grill **ONLY** per the instructions in the Assembly Guide and this Owner's Manual.
- This grill is intended for **OUTDOOR USE ONLY**.
- Never use heating fuel pellets in the grill, due to potential hazardous contaminants and additives that may be present.

## CAUTION!

- Always store wood pellets in a dry location, away from heat-producing appliances and other fuel containers.
- Keep the grill clean. See the cleaning instructions in this Owner's Manual.
- Do not use accessories not specified for use with this grill.
- For best results and flavor, use genuine **TRAEGER® BRAND HARDWOOD PELLETS**.
- Even if there is ample room in the grill, be cautious of loading excessive amounts of food that can release large quantities of flammable grease, for example more than a pound of bacon, especially if the grill has not been well-maintained. If your previous cooks have produced large quantities of flammable grease, it is highly recommended that the grease be cleaned from the grill before using it again.

### For Consumers in the European Union:

- This appliance is not intended for use by persons (including children) with reduced physical, sensory, or mental capabilities, or lack of experience and knowledge, unless they have been given supervision or instruction concerning use of the appliance by a person responsible for their safety.
- Children should be supervised to ensure they do not play with the appliance.

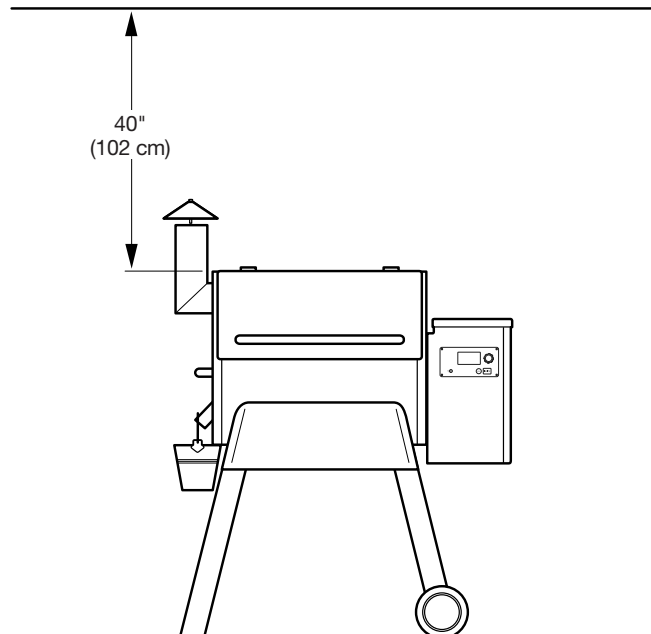

**SAVE THESE INSTRUCTIONS**



**LIVE  
FLAVOR  
FULL**



# **TABLE OF CONTENTS**

<b>2</b>	<b>IMPORTANT SAFETY</b>
<b>6</b>	<b>WHY TRAEGER WOOD PELLETS?</b>
<b>7</b>	<b>MAKE GRILL MAINTENANCE A REAL BREEZE</b>
<b>8</b>	<b>GETTING TO KNOW YOUR GRILL</b>
<b>11</b>	<b>SEASONING YOUR GRILL</b>
<b>13</b>	<b>USING YOUR GRILL</b>
<b>14</b>	<b>CHOOSING A COOK METHOD</b>
<b>17</b>	<b>ADDITIONAL CONTROL FUNCTIONS</b>
<b>18</b>	<b>HOPPER CLEAN-OUT</b>
<b>19</b>	<b>PRO SERIES FEATURES</b>
<b>20</b>	<b>MAINTAINING YOUR GRILL</b>
<b>22</b>	<b>FREQUENTLY ASKED QUESTIONS</b>
<b>24</b>	<b>TROUBLESHOOTING</b>
<b>25</b>	<b>OPERATING TIPS</b>
<b>27</b>	<b>SERVICE AND WARRANTY</b>

# WHY **TRAEGER** WOOD PELLETS?

**AT TRAEGER, WE'RE BIG ON TASTE.** That's why we create our own 100% all-natural hardwood pellets, ensuring only the best quality wood is used to flavor your food and burn the most efficiently and reliably. We can't guarantee the same results from other pellet brands, so we always recommend using our pellets for the optimal experience.

## 100% ALL-NATURAL HARDWOOD

No fillers, no unnatural additives—just pure hardwood for pure flavor.

## WOOD-FIRED TASTE & SMOKE SCIENCE

Just the right moisture ratio results in highest-quality pure hardwood flavor.

## USA TRAEGER-OWNED MILLS & PELLET PRODUCTION PROCESS

After 30 years in business, we've created the "gold standard" in pellet production.

TRAERGER HARDWOOD	GOOD WITH ANYTHING. GREAT WITH:							
	BEEF	POULTRY	PORK	LAMB	SEAFOOD	BAKED	VEGGIES	WILD GAME
ALDER								
APPLE								
CHERRY								
HICKORY								
MAPLE								
MESQUITE								
OAK								
PECAN								
BIG GAME BLEND								
TURKEY BLEND								
TEXAS BEEF BLEND								
SIGNATURE BLEND								

# MAKE GRILL MAINTENANCE A REAL BREEZE

**MAKING SURE YOUR GRILL IS CLEAN** and free of built-up grease and debris is critical for keeping the pure, wood-fired flavor of your grill intact. The best way to ensure this is by using our lineup of cleaning and maintenance materials, available at your local dealer or online at [traegergrills.com](http://traegergrills.com).

950 ML  
**TRAEBER ALL NATURAL  
CLEANER**

Keep your grill as clean and shiny as the day you got it with our All Natural Cleaner.



5-PACK  
**GREASE BUCKET  
LINERS**

Get a grip on your drip bucket maintenance with our aluminum liners.



5-PACK  
**DRIP TRAY  
LINERS**

Made of heatproof aluminum, they're lightweight and disposable so you can clean up quick and Traeger on.



18" X 150'  
**TRAEBER X OREN  
PINK BUTCHER PAPER**

This FDA-approved paper keeps your meat moist by sealing in the juices, but is breathable enough to allow additional smoke flavor in.



# GETTING TO KNOW YOUR GRILL

Refer to the Assembly Guide to assemble and install your Traeger® Pro Series Grill.

## GRILL PARTS AND FEATURES

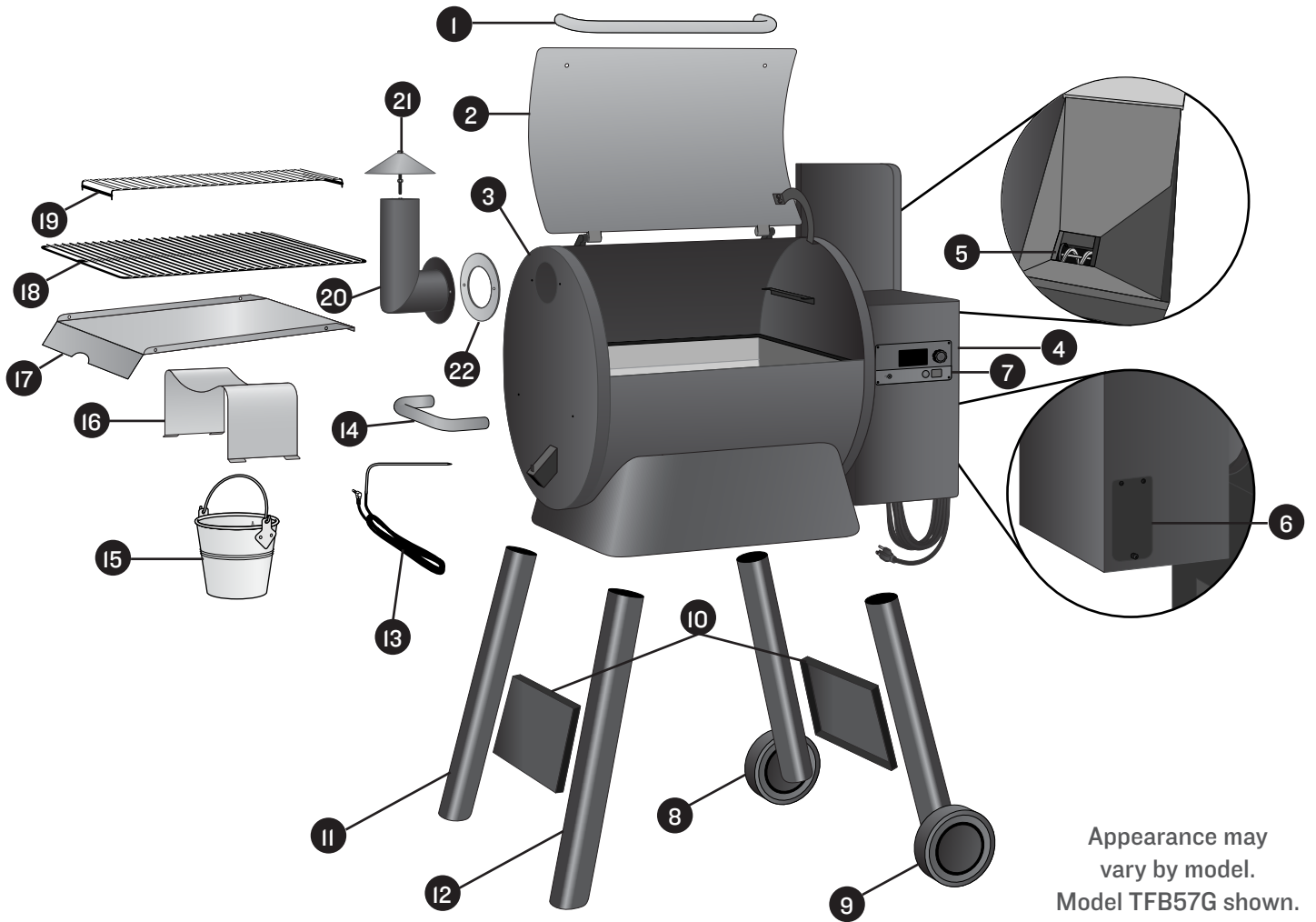

Appearance may vary by model.  
Model TFB57G shown.

Part	Description	Part	Description
1	Grill Door Handle	12	Front Fixed Leg
2	Grill Door	13	Meat Probe
3	Grill Body	14	Side Lift Handle
4	Pellet Hopper	15	Grease Bucket
5	Auger (Pellet Hopper Interior)	16	Heat Baffle
6	Pellet Hopper Clean-out Door	17	Grease Drip Tray
7	Traeger Controller with WiFIRE® Technology	18	Porcelain-Coated Grill Grate
8	Rear Wheeled Leg	19	Porcelain-Coated Top Grill Grate
9	Front Wheeled Leg	20	Chimney Pipe
10	Leg Braces	21	Chimney Cap
11	Rear Fixed Leg (swivel castors on model 780)	22	Chimney Pipe Gasket

### PELLET HOPPER

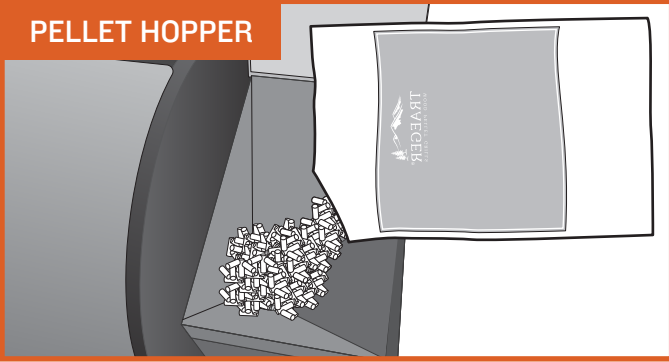

An 18 lb. (8.2 kg) capacity pellet hopper will keep you cooking for hours. Pair that with Traeger's Controller with WiFIRE® Technology and delicious food is just a "click" away.

### BARREL SHAPE

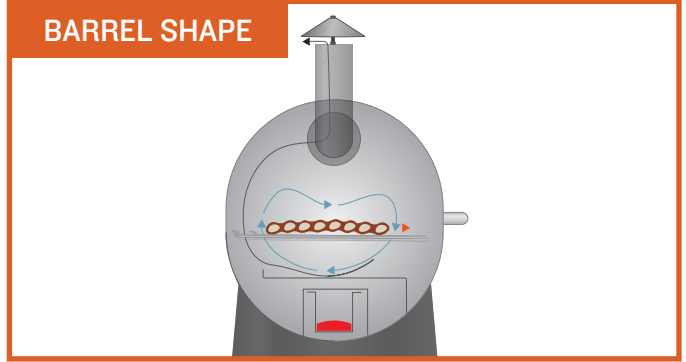

Traeger's signature barrel shape creates a vortex of convection. It circulates hot, smoky air around the cooking chamber, surrounding your food with wood-fired heat for even cooking on all sides.

### GRILLING SPACE

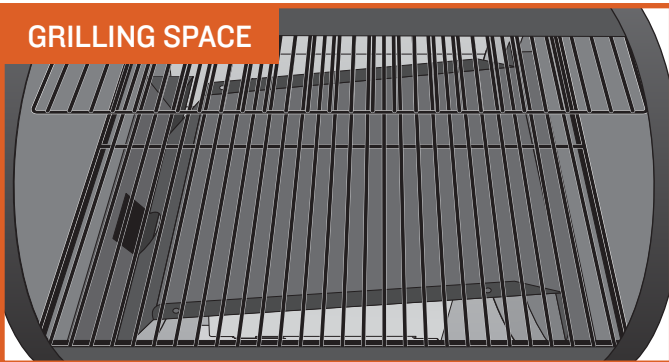

With 575-780 in.<sup>2</sup> (0.37-0.50 m<sup>2</sup>) of grilling space, your Traeger grill has the real estate for party-sized orders of T-bones or racks of ribs.

### HIGH-TECH CONTROLS

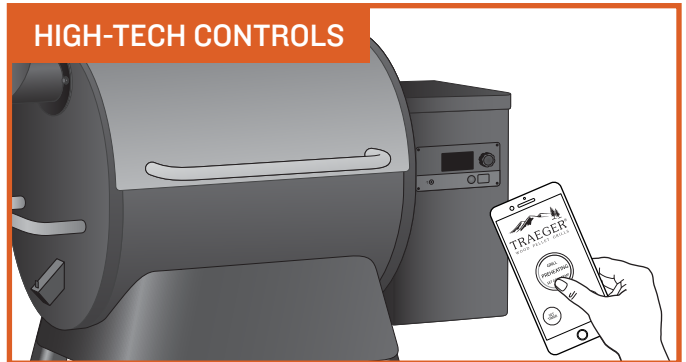

With the Traeger® Pro Series Grill, controlling your grill is as easy as pulling out your phone. The WiFIRE® Technology allows you to set and adjust temperatures automatically with recipes downloaded from our Traeger app. To download the app for Android, go to the Google Play Store; for Apple, go to the App Store. For information on how to use the app, go to [traegergrills.com/wifire](http://traegergrills.com/wifire). See "Connecting Your Grill" section on next page for instructions on how to connect to Wi-Fi.

### VERSATILITY



An adjustable 2-tier grate system offers options to load up both grill grates for a true feast; remove the top grate for taller food like a colossal turkey.

### NO FIREFIGHTING

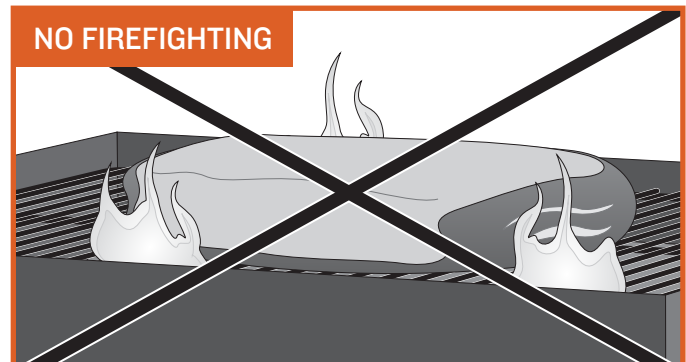

You don't have to worry about drippings flaring up and causing nasty fireballs that destroy your meal because Traeger Wood Fired Grills cook by using indirect heat. All drippings are safely channeled into an external grease bucket for easy disposal.



**WARNING!** Keep your grill clean. See "Operating Tips" and "Maintaining Your Grill."

# GETTING TO KNOW YOUR GRILL (CONTINUED)

## YOUR WiFIRE® ELECTRONIC CONTROLLER

Your Traeger® Pro Series Grill is equipped with a state-of-the-art Traeger Controller with WiFIRE® Technology that is Wi-Fi-capable. Before you begin using the grill, it will be helpful to familiarize yourself with the different features of the control panel.

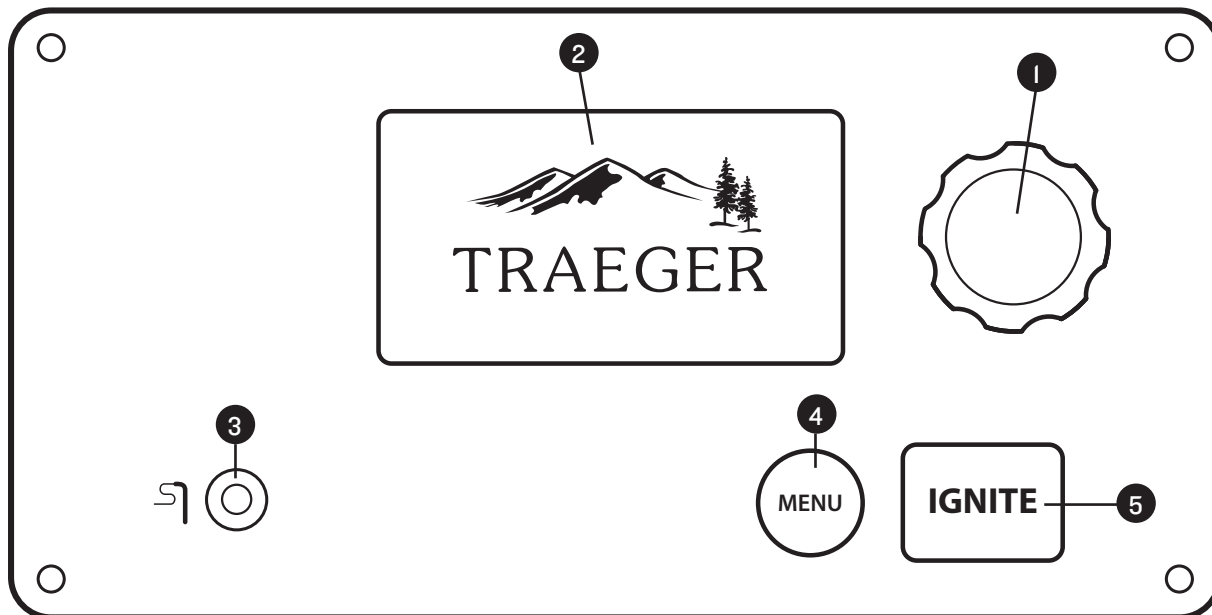

### 1 SELECTION DIAL

Rotate dial to move up and down through the display menu and to adjust temperature. Press the center of the dial to make a selection. Press and hold for 3 seconds to initiate the shutdown cycle. Always run your grill through the full shutdown cycle after each cooking task. See “Maintaining Your Grill” for more information.

### 2 STATUS DISPLAY

Shows current temperature, status of cook program, cook time remaining, etc.

### 3 MEAT PROBE JACK

Plug the meat probe into the jack for probe cooking.

### 4 MENU

From MENU, you can set up the meat probe and sync your grill with your home’s Internet and settings.

### 5 IGNITE

Press IGNITE to start the grill.

#### NOTES:

- Press any button or the dial to turn on the electronic controller once the grill’s Main Power switch (located on the back of the grill) has been turned ON (I).
- Temperature fluctuations are normal for Traeger grills. Any significant fluctuation could be the result of wind, air temperature, improper use, or lack of grill maintenance.

## CONNECTING YOUR GRILL

Follow these instructions to connect your grill to Wi-Fi. To learn more about WiFIRE®, the Traeger app, and more ways to connect, go to [traegergrills.com/wifire](http://traegergrills.com/wifire).

#### NOTES:

- Make sure your smart device is running the latest operating system.
- To connect your grill to Wi-Fi, your grill must be powered on. Make sure the Main Power switch is in the ON (I) position and the grill controller display is on the home screen.

1. Download the Traeger app at the Google Play store for Android or the App Store for Apple.
2. Ensure your smart device is connected to the Wi-Fi network to which you want your grill connected.
3. Open the Traeger app and follow the instructions.

#### TIPS:

- For best connectivity results, have your grill facing the direction of your Wi-Fi router. Ensure you have a strong Wi-Fi signal where you will use your grill.
- A Wi-Fi extender can help improve your Wi-Fi strength.

# SEASONING YOUR GRILL

**TO BE USED ON INITIAL FIRING ONLY.** In order to ensure proper operation of the grill, you must first prime the auger by allowing the auger tube to be “charged” with pellets.

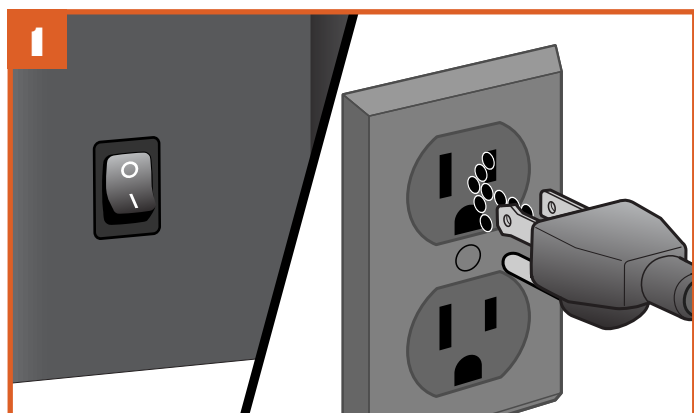

PLUG APPEARANCE MAY VARY BY REGION.

With the Main Power switch in the OFF (O) position, plug the power cord into an appropriate grounded/earthed electrical outlet.

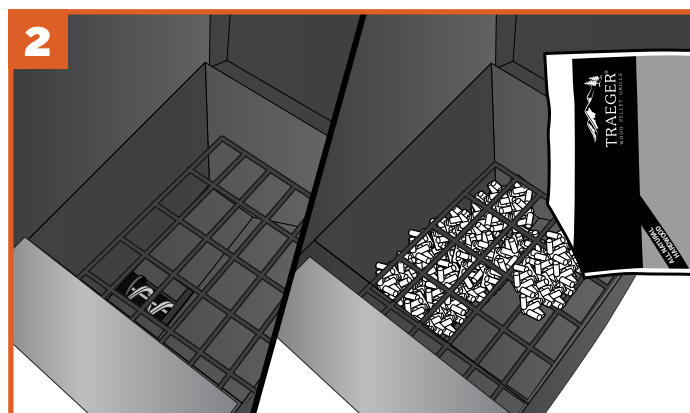

Make sure there are no foreign objects in the auger before adding pellets to the hopper.



**WARNING!** Use ONLY TRAEGER® BRAND HARDWOOD PELLETS, which are specifically made to work in our grills. Never use heating fuel pellets in the grill.

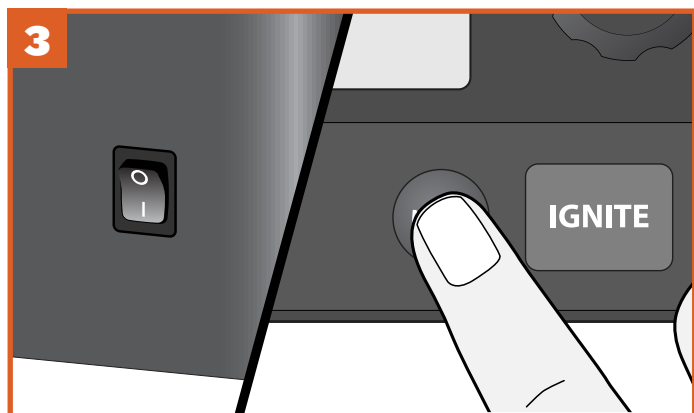

Turn grill on: Flip the Main Power switch on the back of the grill to ON (I), **press any button on the control panel to activate** the WiFIRE® Electronic Controller. After a few seconds, the home screen will display.

**NOTE:** The seasoning reminder will display the first few times you power up the grill. However, you only have to season your grill upon initial start-up.

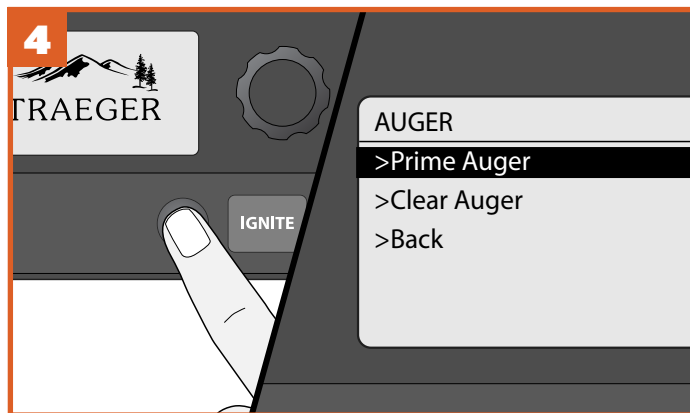

Press MENU to display the main menu. Turn the dial to select AUGER, then select Prime Auger.

The auger tube should take approximately 2 minutes to fill with pellets and begin dispensing into the firepot. Once pellets begin to fall into the firepot, select Back to turn off the auger. You only need a few pellets in the firepot to season your grill.

# SEASONING YOUR GRILL (CONTINUED)

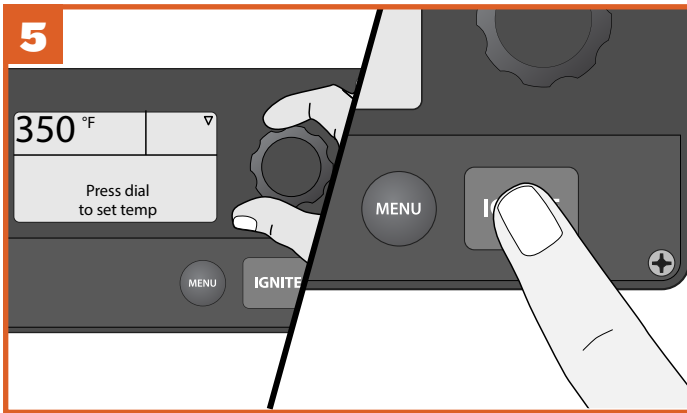

The home screen will display “Press dial to set temp.” Turn the Selection dial clockwise to 350°F (177°C). Press IGNITE, close grill door, and run grill for 20 minutes once it has reached the set temperature.

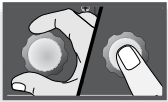

**NOTE:** Whenever you're instructed to select or confirm a menu option, turn the Selection dial to the desired option and press the center of the dial to lock in your selection.

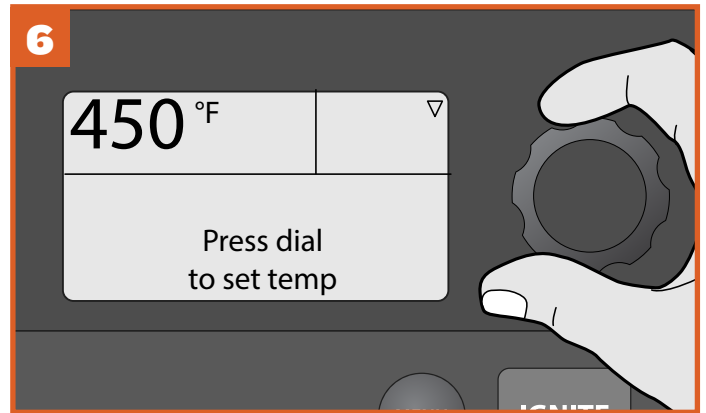

After completing Step 5, adjust temperature to 450°F (232°C) and run grill for an additional 30 minutes.

**NOTE:** If the auger jams during use, allow grill to cool completely, then press MENU to display the main menu. Turn the dial to select AUGER, then select Clear Auger. The auger will run backwards for 60 seconds to clear any jammed pellets.



Turn off the grill by pressing and holding the Selection dial for 3 seconds, initiating the shutdown cycle. When the full shutdown cycle finishes, seasoning of your grill is complete.

# USING YOUR GRILL

YOU WILL NEED TO BEGIN WITH THESE STEPS EVERY TIME YOU USE YOUR GRILL.

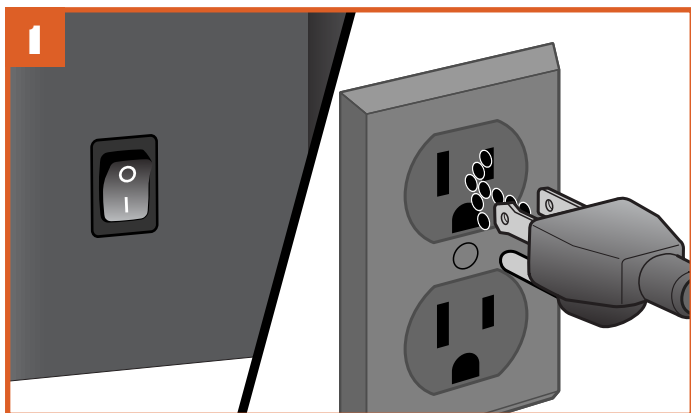

PLUG APPEARANCE MAY VARY BY REGION.

Plug power cord into an appropriate grounded/earthed electrical outlet and flip Main Power switch to ON (I).



Press any button to wake the controller.

## WARNING!

- When operating this grill, maintain a minimum clearance of 18 inches (45.7 cm) from grill to combustibles.
- Use ONLY TRAEGER® BRAND HARDWOOD PELLETS, which are specifically made to work in our grills. Never use heating fuel pellets in the grill.

## NOTES:

- The Traeger app for your mobile device makes operating your WiFIRE® Electronic Controller even easier. To connect to your grill, download the Traeger app and follow the instructions. To learn more about WiFIRE®, the Traeger app, and more ways to connect, go to [traegergrills.com/wifire](http://traegergrills.com/wifire).
- Whatever cook method you choose, your Traeger® Pro Series Grill will always begin with an ignition and preheat cycle once you press IGNITE.
- Always run your grill through the full shut-down cycle after each cooking task. Press and hold the dial to initiate the shut-down cycle.
- We recommend you clean the grease drip tray frequently to reduce the possibility of a grease fire. Please see “Maintaining Your Grill” on page 20 for more details.

# CHOOSING A COOK METHOD

**COOKING AT A SINGLE TEMPERATURE** Use this method for simple recipes requiring a single cook cycle at a set temperature.

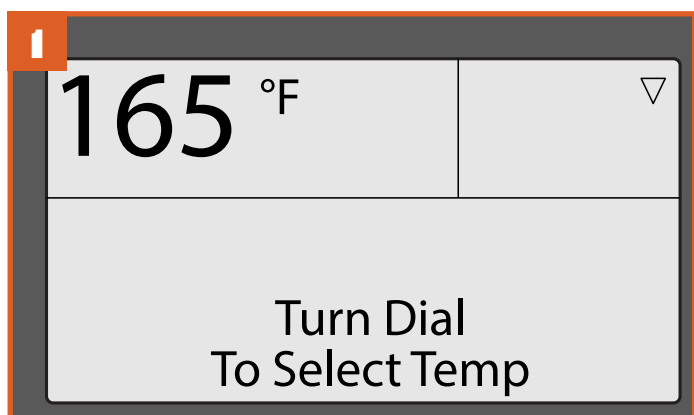

After turning ON (I) the Main Power switch, your grill's home screen defaults to the "Turn Dial To Select Temp" message. Cooking temperature can be set directly from this screen.

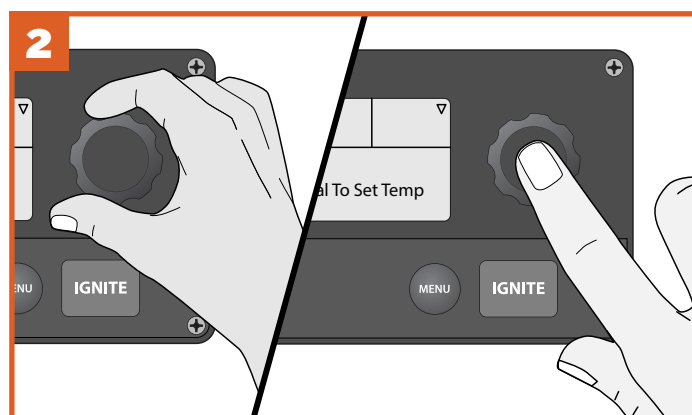

To select temperature, turn Selection dial right or left; once desired temperature is displayed, press the center of the dial to select.



Press IGNITE. The automatic ignition and preheat cycle will begin.



Once preheating is complete, load food into the grill and close the grill door.

**NOTE:** The grill door should be closed once preheating begins.

## TIPS:

- It is recommended, but not necessary, to wait until the preheat cycle is complete before loading food into the grill.
- It is not necessary to keep the grill door open at start-up; however, the grill door should be closed once the preheat cycle begins so that the grill can reach the desired set temperature.
- Some temperature fluctuations are normal for Traeger grills.

## COOKING WITH THE PROBE

Use these methods when your recipe specifies an internal goal temperature for your food.

### If the grill is turned off:

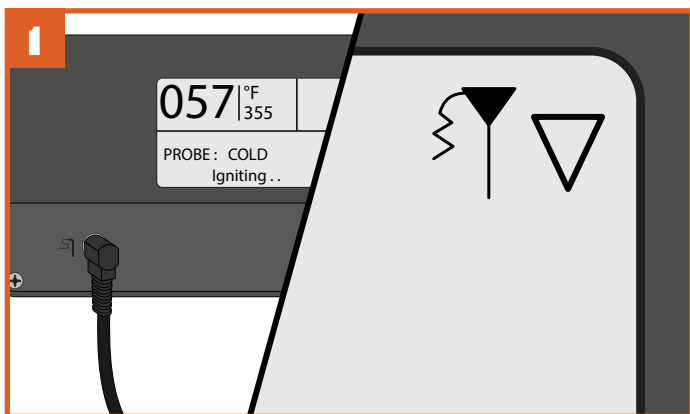

Plug the probe into the probe jack located on the WiFIRE® Controller. See “Using Your Grill” to turn on the grill. Once the grill is on, the controller will recognize the probe and the probe icon will light in the controller screen’s upper-right corner.

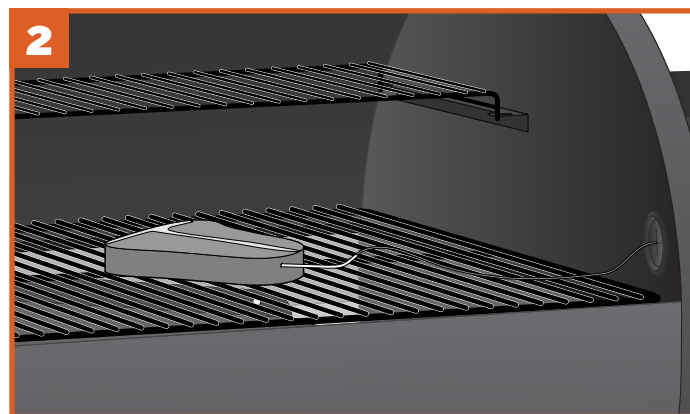

Once the grill is preheated to the desired temperature, load food into the grill. Feed the probe through the grommet on the side of the grill and insert the probe tip halfway into the thickest part of the meat—not in the fatty portion or touching bone.

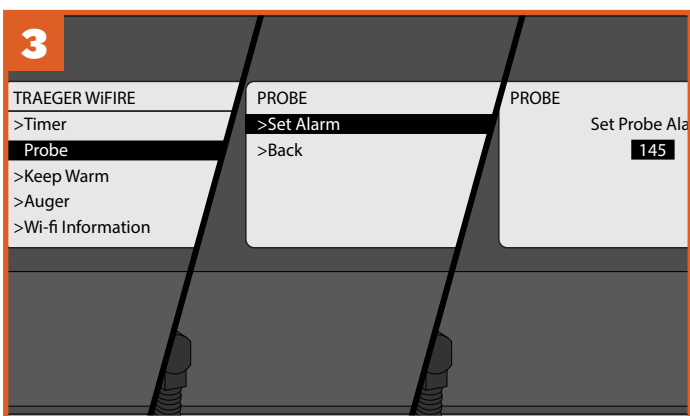

Press MENU; then scroll and select PROBE. You will be prompted to set a probe alarm for the internal goal temperature. Select SET ALARM. Then, at the probe menu, use the Selection dial to choose the temperature goal for your meat.

**NOTE:** To calibrate the probe, see “Additional Control Functions” on page 17.

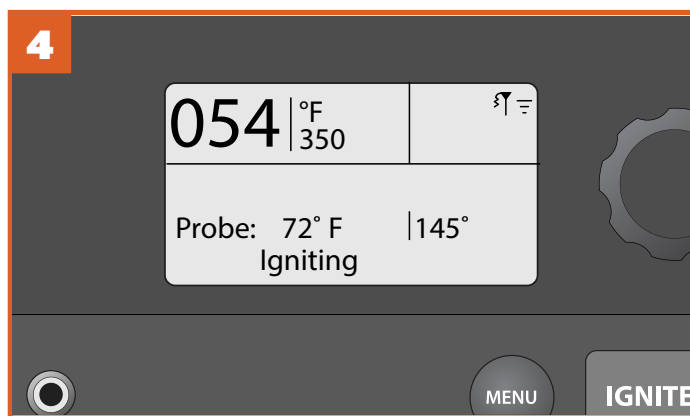

Once the probe alarm is set, the home screen will display the grill temperature, goal probe temperature, and grill status. A tone will sound when your meat reaches the set alarm temperature. If using the Traeger WiFIRE® app, you will receive a push notification on your connected smart device, along with a display of your grill’s status throughout the cooking process.

## COOKING WITH THE PROBE (continued)

If the grill is turned on:

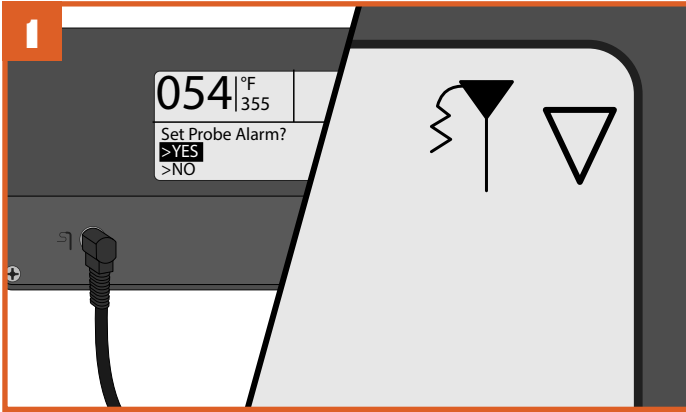

Plug the probe into the probe jack located on the WiFIRE® Controller. The controller will recognize the probe and the probe icon will light in the controller screen's upper-right corner. The display will ask if you want to set an alarm. Select YES.

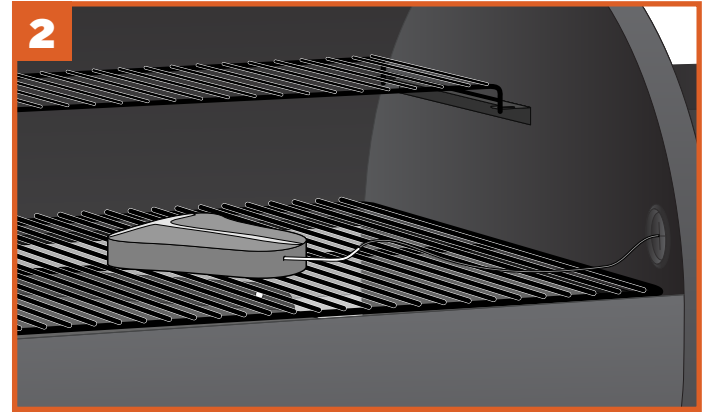

Once the grill is preheated to the desired temperature, load food into the grill. Feed the probe through the grommet on the side of the grill and insert the probe tip halfway into the thickest part of the meat—not in the fatty portion or touching bone.

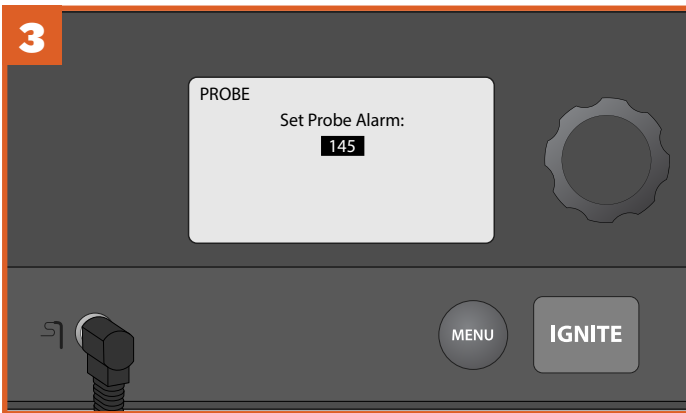

Rotate the dial to the desired food temperature. Press the dial center to select/confirm.

**NOTE:** To calibrate the probe, see "Additional Control Functions" on page 17.

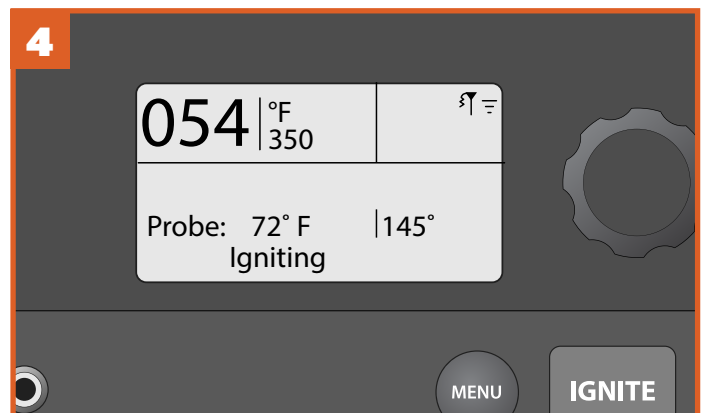

Once the probe alarm is set, the home screen will display the grill temperature, goal probe temperature, and grill status. A tone will sound when your meat reaches the set alarm temperature. If using the Traeger WiFIRE® app, you will receive a push notification on your connected smart device, along with a display of your grill's status throughout the cooking process.

# ADDITIONAL CONTROL FUNCTIONS

**SETTINGS** Use the Settings menu to adjust display settings, clear notifications, access important product and contact information, and more.

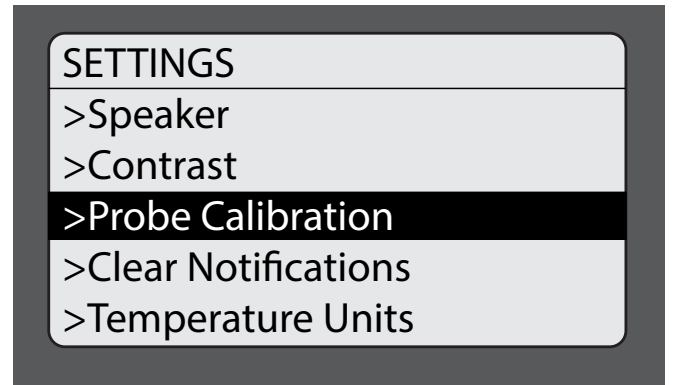

## TO ACCESS THE SETTINGS MENU:

Turn grill on. Once the home screen is displayed, press MENU. The main menu will display several options. Turn the dial to highlight “Settings.” Press the center of the dial to select.

To change a setting, turn the dial to select the desired setting. Press the center of the dial to confirm. Select Back to return to the Settings menu.

### SPEAKER

Turns the grill control speaker on or off. The selected setting will be indicated with a \*.

### CONTRAST

Rotate the dial to adjust the display contrast from 1 (high) to 5 (low). Default setting is 3. Press the center of the dial to confirm and return to the Settings menu.

### PROBE CALIBRATION

There are two options under this setting:

1. Calibrate Probe: Provides instructions on calibrating using an ice water bath. “Place probe in ice water for 1 minute before calibrating.” is displayed.
2. Probe Offset: Rotate the dial to adjust the probe temperature offset in 1° increments, from -15°F to +15°F/-8°C to +8°C. The default setting is 0. Press the center of the dial to confirm and return to the Settings menu.

### CLEAR NOTIFICATIONS

Use this function to clear error messages and notifications.

**NOTE:** Since an error will put the grill into Cool Down mode, the display will still show “Cooling Down” when you exit the Clear Notifications and Settings menus.

### TEMPERATURE UNITS

Turn the dial to choose between degrees Fahrenheit (°F) and Celsius (°C). Press the center of the dial to confirm. The selected setting will be indicated with a \*.

### CUSTOMER SERVICE

Displays the Traeger WiFIRE® dedicated customer service number.

### ABOUT GRILL

Provides important information about your grill, including model number and software version.

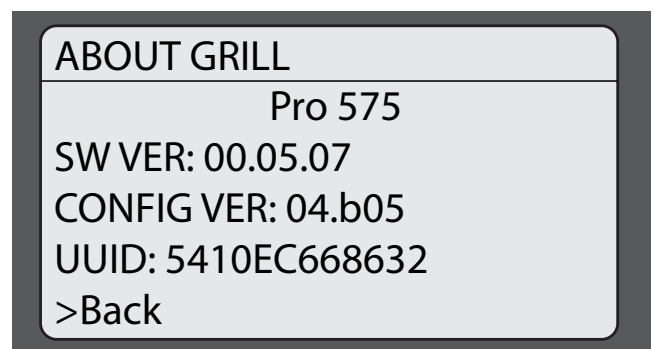

### BACK

Return to the main menu.

# HOPPER CLEAN-OUT

Your Traeger grill has a hopper clean-out system that allows you to quickly change from one pellet flavor to another without making a mess.

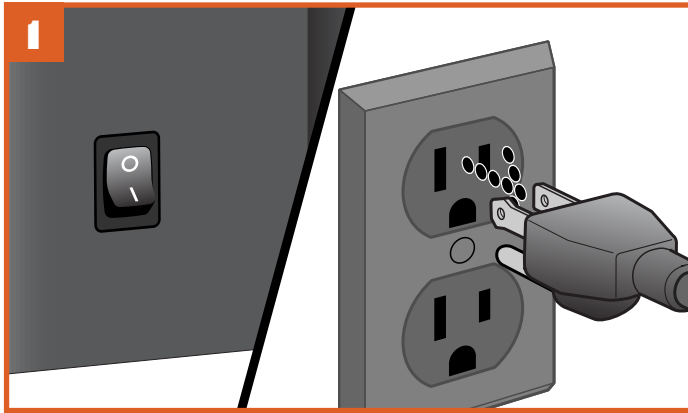

**PLUG APPEARANCE MAY VARY BY REGION.**

Turn the switch to OFF (0) and disconnect the power cord. If the grill is still hot, allow it to cool completely.



Place a container large enough to hold the discarded pellets under the pellet clean-out door.

**TIP:** A clean 5-gallon bucket works great!

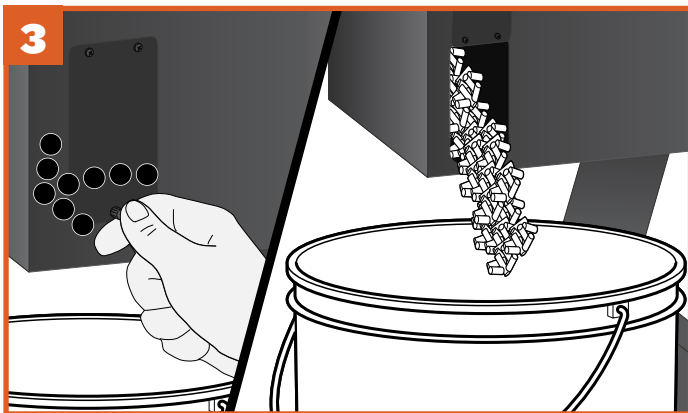

Unscrew the clean-out door fastener and open it. Pellets will empty into the container you've placed below. You might need a spatula or spoon to push the remaining pellets out of the hopper.

 **WARNING!** Carefully empty out hopper soon after grill use. Pellets may be very hot.

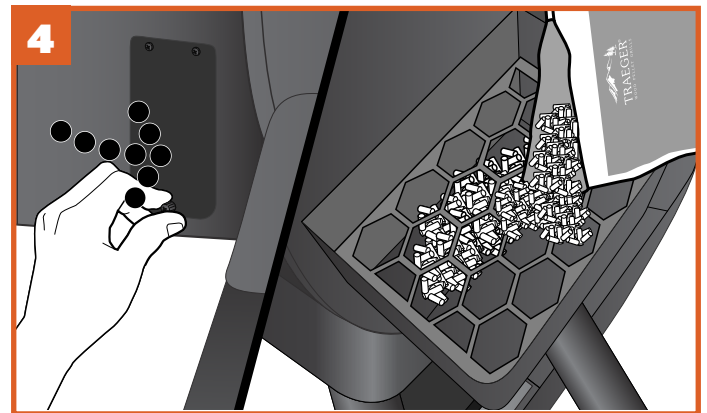

Once the hopper's empty, close the door, replace the fastener, and refill the hopper with a different flavor of **TRAEGER® BRAND HARDWOOD PELLETS**.

# PRO SERIES FEATURES

## TRAEGER APP

Your Traeger® Pro Series Grill can be controlled remotely using the Traeger app. To learn more about WiFIRE®, the Traeger app, and more ways to connect, go to [traegergrills.com/wifire](http://traegergrills.com/wifire).

You will need a home Internet Wi-Fi connection to connect your Traeger® Pro Series Grill to the Internet. It is required that your smartphone or tablet is running the latest iOS or Android operating system. If you leave the range of your home Wi-Fi network with your device, a data plan is required.

The Traeger app is also an easy way to search, download, and cook new recipes on your Traeger® Pro Series Grill.

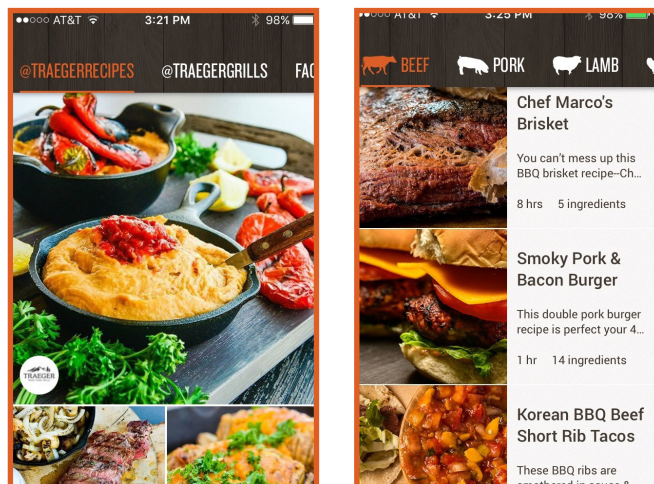

## TIMER

Your Traeger® Pro Series Grill comes equipped with a convenient timer. The Timer function does not impact grill operation; you can use it to notify you of other needed steps during cooking, such as loading vegetables into the grill or basting your food.

### To set the Timer:

1. Select Timer from the menu.
2. Use the Selection dial to toggle between hours and minutes to set the time.

Once the dial is pressed after choosing the time, the Timer is set and you will be returned to the home screen.

### To cancel the Timer:

1. Press the center of the Selection dial until the time remaining is displayed.
2. You will see the options to Edit, Cancel, or go Back to the menu.

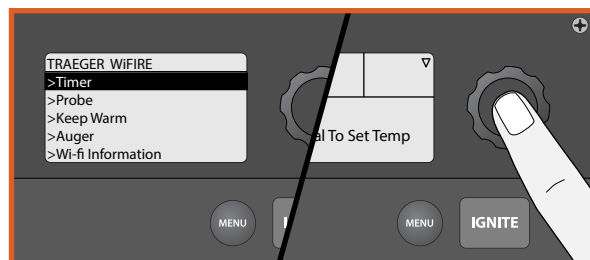

## KEEP WARM FUNCTION

Keep Warm (in the menu) can be used to pause the cook cycle at any time during grilling and maintain the grill temperature at 165°F (74°C). Select Keep Warm again to resume cooking.

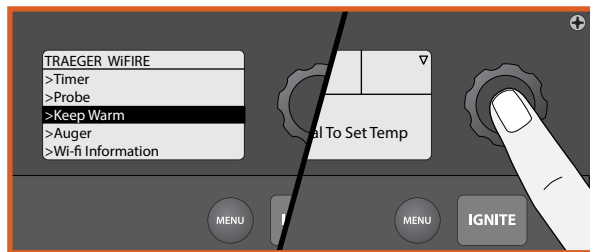

## GRILL COVER

Protect your Traeger® Pro Series Grill with a premium custom cover, designed to withstand the elements. This durable grill cover is available for purchase at [traegergrills.com](http://traegergrills.com).

# MAINTAINING YOUR GRILL

## 1. CREOSOTE AND GREASE FORMATION AND REMOVAL

When wood pellets are burned slowly, they produce tar and other organic vapors that combine with expelled moisture to form creosote. The creosote vapors condense in the relatively cool exhaust vent of a slow-burning fire. As a result, creosote accumulates on the exhaust vent lining. When ignited, creosote makes an extremely hot fire. Airborne grease particles will travel through the cooking chamber, and some of this airborne grease will accumulate on the exhaust vent lining, similar to creosote, which could contribute to a fire.

The Traeger Downdraft Exhaust should be inspected at least twice a year to determine when a creosote and/or grease buildup has occurred.

Grease drippings will flow from the grease drip tray to the grease channel, out of the grill through the grease chute, and collect in the grease bucket. These are the components of the Traeger Grease Management System (TGMS). Grease will accumulate in all of these locations.

All components of the TGMS should be inspected before each use for signs of grease buildup.

When creosote or grease has accumulated, it should be removed to reduce the risk of fire.

Even if there is ample room in the grill, be cautious of loading excessive amounts of food that can release large quantities of flammable grease, for example more than a pound of bacon, especially if the grill has not been well-maintained. If your previous cooks have produced large quantities of flammable grease, it is highly recommended that the grease be cleaned from the grill before using it again.

## 2. CLEANING INSIDE SURFACES:

**DANGER!** Turn the switch OFF (O) and disconnect the power cord.

**CAUTION!** Accumulated grease is easier to clean off when the grill is still warm—not hot. Be careful not to burn yourself. Gloves are recommended.

Periodically clean the grease out of the V-shaped grease drain and grease drain tube. If too much grease is allowed to build up in the V-shaped grease drain or is allowed to plug the grease drain tube, a grease fire could result. We recommend cleaning these locations regularly.

Remove all grill grates and the grease drip tray. This will provide access to the V-shaped grease drain and grease drain tube opening inside the grill. Scrape the grease accumulation from inside the V-shaped grease drain and grease drain tube using a stiff, nonmetallic tool. Much of the loosened grease can be pushed down through the grease drain tube and will fall into the grease bucket. Wipe up remaining grease residue with paper towels or disposable rags. Paper towels or disposable rags can also be used to wipe some of the grease off of the interior surfaces of the grill.

## 3. CLEANING OUTSIDE SURFACES:

**DANGER!** Turn the Main Power switch OFF (O) and disconnect the power cord.

Use a disposable rag or cloth dampened with warm, soapy water to wipe the grease from the outside of the grill. DO NOT use oven cleaner, abrasive cleansers, or abrasive cleaning pads on the outside grill surfaces.

## 4. OUTSIDE STORAGE:

**CAUTION!** If the grill is stored outside during the rainy season, care should be taken to ensure that water does not get into the pellet hopper. Wood pellets expand greatly when wet and will jam your auger. Always cover your grill when not in use with the Traeger grill cover. This custom-fit cover can be purchased at [traegergrills.com](http://traegergrills.com).

## 5. CLEANING THE GRILL GRATES:

**CAUTION!** Cleaning the grill grates works best while they are still warm. Be careful not to burn yourself. We recommend keeping a long-handled cleaning brush near the grill. After removing your food, give the grill grate a quick brushing. It takes only a minute and it will be ready the next time you want to use the grill.

**6. CLEANING THE ASH FROM INSIDE AND AROUND THE FIREPOT (EVERY 20 HOURS OF USE):**

**DANGER!** Turn the Main Power switch OFF (O) and disconnect the power cord.

**WARNING!** Make sure that the grill is COLD before cleaning the ash.

**WARNING!** Disposal of ashes should be done only according to the following instructions.

Excess ash in the firepot may cause your fire to go out. The firepot should be inspected occasionally and cleaned to remove the ash buildup. Again, cleaning the ash from in and around the firepot should be done only when the grill is COLD.

Remove the grill grates, grease drip tray, and heat baffle to provide access to the firepot and the interior of the grill. Much of the ash outside of the firepot can be removed from the grill with a small metal fireplace shovel or other similar tool.

**WARNING!** A dedicated vacuum cleaner is the best way to remove ashes from the firepot, but this must be done with extreme care to avoid the risk of fire. Again, cleaning the ash from the firepot should be done only when the grill is COLD.

A utility-type vacuum cleaner having a metal collection canister without a bag would be best for this task. However, almost any vacuum cleaner will work safely if this procedure is properly followed.

After ensuring that the ash in the firepot is COLD, vacuum the ash from the inside of the firepot.

- a. If your vacuum cleaner is a bagless model, empty any previously accumulated debris from the collection chamber. Then vacuum the ash from the inside of the firepot. Once the firepot is clean, empty the collection chamber into the metal container described below without delay. Make sure that there is no remaining ash residue left in the collection chamber.
- b. If your vacuum cleaner is a model that uses a disposable bag, install an unused bag in the machine. Then vacuum the ash from the inside of the firepot. Once the firepot is clean, remove the bag from the vacuum cleaner and place it in the metal container described below without delay.

**7. DISPOSAL OF ASHES:**

**WARNING!** Ashes should be placed in a metal container with a tight-fitting lid. The closed container of ashes should be placed on a noncombustible floor or on the ground, well away from all combustible materials, pending final disposal. When the ashes are disposed of by burial in soil or otherwise locally dispersed, they should be retained in the closed container until all cinders have cooled thoroughly.

8. If the supply cord is damaged, It must be replaced by a special cord assembly available from the manufacturer or its service agent.

# FREQUENTLY ASKED QUESTIONS

Following are frequently asked questions along with their answers:

QUESTION	ANSWER
<p><b>Why won't my grill ignite?</b></p>	<p>Verify power at the electrical outlet. If the power cord is connected to a GFCI (ground fault circuit interrupter), check and reset if necessary. Initiate start-up. If no ignition, see next answer.</p> <p><b>DANGER!</b> Turn the switch OFF (O) and disconnect the power cord. Remove the control and check the fuse on back. Replace the fuse if blown. Reinstall the control.</p> <p>Check the draft inducer fan and the auger drive motor for operation. If both are operating, the hot rod needs to be replaced. If one or both are not operating, contact Traeger's VIP-365 Customer Service (see page 27) for additional troubleshooting help or to place an order.</p> <p>Verify that there are pellets in the pellet hopper. If this is the initial firing or the grill has run out of pellets, allow sufficient time for the pellets to travel from the pellet hopper to the firepot (can take up to 7 minutes).</p> <p>Initiate start-up. See "Using Your Grill" on page 13. If there are still no pellets in the firepot, proceed to next answer.</p> <p>If the auger drive motor is operating (check the small fan blade on the back of the motor), the problem is in the digital control, which will need to be replaced. Contact your Traeger dealer or Traeger's VIP-365 Customer Service (see page 27) to place an order.</p>
<p><b>Why are no pellets being delivered into the firepot?</b></p>	<p>If the auger drive motor is <b>not</b> operating but the draft inducer fan is operating, the problem is in the auger system, which will need to be checked:</p> <p>With the switch OFF (O), locate the small fan blade on the back of the auger drive motor.</p> <p><b>CAUTION!</b> While watching the fan blade, turn the switch ON (I). If the fan blade does not turn, turn the switch OFF (O). This indicates a defective auger drive motor, and it will need to be replaced. Contact your Traeger dealer or Traeger's VIP-365 Customer Service (see page 27) to place an order.</p> <p>If the fan blade turns a bit and then stops, continue watching and turn the switch OFF (O). If the fan blade unwinds slightly, this indicates a jam in the auger system, which will need to be cleared.</p> <p><b>DANGER!</b> Turn the switch OFF (O) and disconnect the power cord. Remove the pellets from the pellet hopper. Check for foreign objects and wet or decomposed pellets, both of which can cause a jam in the auger system. The auger will need to be removed to clear a jam in the auger system. See "How do I remove the auger if it jams?" section on the following page.</p>
<p><b>Why is the temperature of my grill fluctuating?</b></p>	<p>Temperature fluctuations are normal for Traeger grills. Any significant fluctuation could be the result of wind, air temperature, improper use, or lack of grill maintenance.</p>

QUESTION	ANSWER
<p><b>How do I remove the auger if it jams?</b></p>	<p><b>DANGER!</b> Turn the switch OFF (0) and disconnect the power cord.</p>
	<p><b>CAUTION!</b> If the grill is still hot, allow it to cool thoroughly.</p>
	<p>Remove any covers necessary to access the auger drive motor.</p>
	<p>Remove the screw connecting the auger drive motor shaft to the auger shaft and the screw retaining the auger bushing into the auger tube.</p>
	<p>With a small pipe wrench or locking pliers on the auger shaft, turn the auger counterclockwise. It will turn hard until it breaks free; then the auger will turn freely.</p>
	<p>Remove the auger and clean all pellets, ash, or foreign objects from the auger, auger tube, and firepot. (See instructions for proper handling and disposal of ash on page 21.)</p>
	<p>Sand the outside surfaces of the auger with medium grit sandpaper. Check the inside of the auger tube and sand it if needed. Vacuum the sanding grit out of the auger tube and firepot when finished. Check that the auger rotates freely.</p>
<p>Reattach the auger shaft to the auger drive motor shaft.</p>	
<p><b>How do I protect my paint finish?</b></p>	<p>Use a protective cover on the grill to protect your paint finish. A Traeger grill cover is highly recommended. Covers are available from your Traeger dealer, or log onto our website, <a href="http://traegergrills.com">traegergrills.com</a>.</p>
	<p>Every 90 days, use a high-quality car wax on the outside surfaces of the grill. <b>ONLY APPLY WAX TO A COLD GRILL.</b></p>
<p><b>Where can I get a new part for my grill?</b></p>	<p>Check with your Traeger dealer. They may have the part in stock or can order the part for you.</p>
	<p>Contact Traeger’s VIP-365 Customer Service (see page 27) to place an order.</p>
	<p>In either case, please provide your name, phone number, address, model, and serial number of the grill (located on the label inside the hopper lid), along with the part identification number from the component diagram or parts list.</p>

# TROUBLESHOOTING

Although rare, you may see an error or warning message display on your control panel. Please refer to the following chart for potential issues and how to resolve them:

ERROR MESSAGE	SOLUTION
<b>High Temp Error</b>	This error will occur when the temperature in the grill reaches temperatures above 550°F (288°C) for more than 45 seconds. Let the grill cool, then turn off the grill. Clear out any remaining pellets from the firepot and restart your grill. If the problem persists, call customer service.
<b>Low Temp Error</b>	This error will occur if the temperature of the grill falls below 120°F (49°C) for 10 minutes, causing the grill to go into shutdown mode. To fix, remove any pellets from the firepot and add more pellets to the hopper. Turn the controller off and then on again and restart your grill. If the problem persists, call customer service.
<b>Temp Sensor Out</b>	This error will occur if the temperature of the grill is 695°F (368°C) or above for 10 seconds. This could be an adverse event. Allow the grill to cool down and restart the grill. If the problem persists, call customer service.
<b>Failed to Ignite</b>	This error will occur if the grill is out of pellets or the igniter did not light. Check to see if there are pellets in the hopper and clean out your firepot. If the problem persists, replace your igniter or call customer service.
<b>Igniter Disconnect</b>	This error occurs when the controller does not detect the igniter. Check to see if the igniter is connected and restart your grill. If the problem persists, replace your igniter or call customer service.
<b>Fan Disconnected</b>	This error occurs if the controller does not detect the fan. Make sure the fan is plugged in and restart your grill. If the problem persists, you may need to replace your fan or call customer service.
<b>Auger Disconnected</b>	This error occurs when the controller does not detect the auger motor. Check to see if the motor is plugged in and restart your grill. If the issue persists, replace your auger motor or call customer service.
<b>Auger Overcurrent</b>	This error occurs if the auger motor is damaged or jammed. Use the Clear Auger feature inside the control menu and restart your grill. If the problem continues, you may need to replace your auger motor or call customer service.
<b>Low Temp Warning</b>	This warning will occur if the grill has lost its fire and failed to recover. Check the pellets and restart the grill.
<b>Ignition Warning (App Notification Only)</b>	This warning will occur if the grill has not detected a successful ignition in the expected time. Check the pellets and restart the grill.
<b>Low Ambient Temp</b>	This warning will occur when the ambient temperature falls below -20°F (-29°C) for more than 30 seconds. Although the controller will still work, damage to the controller's display may have occurred. If the grill ignites, check to see if the display operates as expected. If the grill does not ignite, warm the grill and check to see if the display and controller operate as expected. If not, call customer service.
<b>Probe Fell Out</b>	This warning will occur if the probe is not fully inserted into the food. The message is triggered when the probe is above 220°F (104°C) while the grill is running. Reinsert the probe into your food as instructed on pages I5 and I6.
<b>Bad Probe</b>	This warning will occur if the controller detects a short circuit in the probe for 10 seconds. The probe will need to be replaced. To order a new probe, go to <a href="http://traegergrills.com">traegergrills.com</a> .

## ERROR CLEARING

Errors are cleared with the Menu - Settings - Clear Notifications menu item. Since each error will send the grill into a cooldown, if an error is cleared while the grill is cooling down, the main screen will display "Cooling Down . . ." until the cooldown is complete. Note that some errors, like Temp Sensor Out, will trigger again even after clearing them. This is a sign that the conditions that caused the error have not changed. Power-cycling the grill will also clear any errors, as many users are accustomed to.

# OPERATING TIPS

1. You can change the temperature at any time during grilling to increase or decrease cooking temperature. To change between Fahrenheit and Celsius: Select Temperature Units from the menu. Turn the dial to choose between degrees FAHRENHEIT (°F) and CELSIUS (°C). Press the center of the dial to confirm. The selected setting will be indicated with a \*.
2. You will now see temperatures displayed in the format you've chosen.
3. **WARNING!** Your Traeger® Pro Series Grill should never be moved while it is hot. If you are transporting your grill in a vehicle after cooking on it, make sure the fire is completely out and the grill is cold before placing it in any vehicle. Never put water into the firepot; it will jam the auger.
4. Your Traeger® Pro Series Grill is designed to operate with the door closed. Cooking with the door open greatly lengthens your cooking time.
5. **CAUTION!** Never add pellets by hand to a hot firepot. This is dangerous and you may be seriously burned. If you run out of pellets and lose your fire while cooking, let the grill cool completely and start again with the “Hopper Clean-out” instructions on page 18.
6. **CAUTION!** Make sure the heat baffle is properly seated on its locating brackets. If not seated properly, direct heat and flame could come up out of the firepot and cause a grease fire in the grill.
7. Always take into account the type of food you are cooking.
  - Thin foods need high heat and shorter cook times, while thicker foods need low heat and longer cook times.
  - Vegetables take longer to cook than meats at the same cooking temperatures.
  - Always check that the internal temperature of the meat that you are cooking reaches safe temperatures to eat.
  - **The Keep Warm function is not designed to properly cook your food.**
8. **WARNING!** If the fire in the firepot goes out while smoking and there are sufficient pellets still in the pellet hopper, it is important to follow these steps. Failure to do so may cause a hazardous “overfiring” of your grill due to an excess of unburned pellets in the firepot.
  - **DANGER!** Turn the Main Power switch at the back of the grill to OFF (O) and disconnect the power cord. Allow the grill to cool thoroughly. Open the door and remove all food, grill grates, grease drip tray, and heat baffle.
  - **WARNING! Smoke Hazard**  
A pellet overflow condition can occur during start-up, resulting in unusually thick, white smoke that lasts a long time. If this occurs, power down your grill with the Main Power switch and unplug. If this condition continues long enough, gases can build up from partial ignition and fully ignite, causing the lid to “burp.” If this burp occurs and your grill has not been properly maintained as described in “Maintaining Your Grill” on pages 20-21, a grease fire could result. To remedy this condition, let the grill cool down completely, remove all internal components, and thoroughly clean all ash and pellets from the grill and firepot (see page 21, “Cleaning the Ash from Inside and Around the Firepot”).
  - **WARNING!** Remove all unburned pellets and ash from inside and around the firepot. (See instructions for proper handling and disposal of ash on page 21.)
  - Before replacing the heat baffle, grease drip tray, and the grill grates, plug the power cord into an appropriate grounded/earthed electrical outlet and turn the switch ON (I). Pellets should fall into the firepot and the hot rod should begin to heat (it will start to turn red). **CAUTION!** Do not touch the hot rod.
  - When flames start to come out of the firepot, turn the switch OFF (O). Let the grill cool down. Now you're ready to place the heat baffle, grease drip tray, grill grates, and food back into the grill.

# OPERATING TIPS (CONTINUED)

## 9. CARBON MONOXIDE:

**WARNING!** Follow these guidelines to prevent this colorless, odorless gas from poisoning you, your family, your pets, or others.

Know the symptoms of carbon monoxide poisoning: headaches, dizziness, weakness, nausea, vomiting, sleepiness, and confusion. Carbon monoxide reduces the blood's ability to carry oxygen. Low blood oxygen levels can result in loss of consciousness and death.

See a doctor if you or others develop cold- or flu-like symptoms while cooking or in the vicinity of this appliance. Carbon monoxide poisoning, which can easily be mistaken for a cold or flu, is often detected too late.

Alcohol consumption and drug use increase the effects of carbon monoxide poisoning.

Carbon monoxide is especially toxic to mother and child during pregnancy, infants, the elderly, smokers, and people with blood or circulatory system problems, such as anemia or heart disease.

## 10. GREASE MANAGEMENT:

**CAUTION!** Grease fires are caused by not properly maintaining the grill and failing to clean the Traeger Grease Management System (TGMS) on a consistent basis (see "Maintaining Your Grill"). In the unlikely event of a grease fire while cooking, turn the grill off and keep the door closed until the fire is completely out. Never keep the door open during a grease fire. If the fire does not go out, lightly sprinkle baking soda on the fire.

**CAUTION! Be careful not to burn yourself.** If this does not work, carefully remove the food from the grill and keep the door closed until the fire is completely out. Again, be careful not to burn yourself. When the grill is completely cool, remove all internal components. Clean any grease accumulation from the TGMS. Replace the grease drip tray and grill grates, restart the grill, and resume cooking.

# SERVICE AND WARRANTY



**TRAEGER'S LEGENDARY CUSTOMER SERVICE** is the best out there. If you have any questions about your Traeger grill or need tips on cooking your first Thanksgiving turkey, our seasoned experts have your back. We're here for you 365 days a year, including holidays, because we're cooks—not bankers.

For assistance with assembly or installation, parts, or customer service (English only, please), you can phone, e-mail, or write us at:

## TRAEGER'S CUSTOMER SERVICE

Phone: 1-844-9WiFIRE  
6:00 a.m. – 8:00 p.m. MT  
E-mail: [service@traegergrills.com](mailto:service@traegergrills.com)

## TRAEGER PELLETT GRILLS LLC

1215 E. Wilmington Ave.  
Salt Lake City, UT 84106



## 3-YEAR LIMITED WARRANTY (U.S.A. ONLY)

Traeger Pellet Grills LLC warrants this barbecue grill against defects in material and workmanship under normal use and maintenance for a period of three (3) years from the date of original purchase.

Traeger Pellet Grills LLC will provide a replacement part for any part found to be defective. Original part(s) approved for return by Traeger's Parts Department must be returned prepaid.

This warranty does not include labor charges connected with the determination or replacement of defective parts, or freight charges to ship these parts.

Traeger Pellet Grills LLC shall not be liable under this or any implied warranty for incidental or consequential damages. This warranty gives the retail customer specific legal rights and the customer may have other rights which vary from state to state.

This warranty shall be void if the unit is not assembled or operated in accordance with the operation instructions provided with this unit; the unit is resold or traded to another owner; components, accessories, or fuels not compatible with the unit have been used; the unit has been used in a commercial or food service application; or the user has abused or otherwise failed to maintain the unit.

To process a warranty claim, Traeger Pellet Grills LLC may require proof of your date of purchase. You should retain your sales slip or invoice along with this certificate with your valuable documents.





# LIVE FLAVOR FULL

**FOLLOW US @TRAEGERGRILLS**



Traeger Pellet Grills LLC  
1215 E. Wilmington Ave  
Salt Lake City, UT 84106

[traegergrills.com](http://traegergrills.com)