

This Owner's Manual is provided and hosted by [Appliance Factory Parts](#).



FRIEDRICH SQ08N10 Owner's Manual

[Shop genuine replacement parts for FRIEDRICH
SQ08N10](#)



[Find Your FRIEDRICH Air Conditioner Parts - Select From 1577 Models](#)

----- Manual continues below -----



F R I E D R I C H

2012

Room Air Conditioners

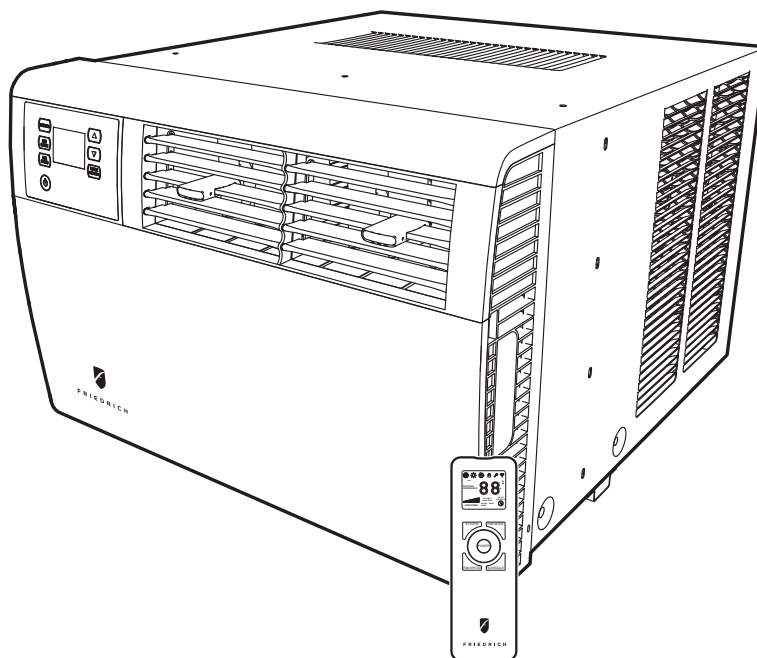

Q Chassis Models

Kühl

Cool Only

115-Volt: SQ05N10*, SQ06N10*, SQ08N10*, SQ10N10*

Kühl +

Cool and Electric Heat

115-Volt: EQ08N11*

Table Of Contents

Important Safety Information	2-4
Introduction	4
Unit Identification	5
Performance Data	6
Chassis Specifications	6
Installation Information/Sleeve Dimensions	6
Electrical Data	7
Before Operating the Unit	8
For Best Cooling Performance and Energy Efficiency	8
Kuhl Q Control Panel Operation and Symbols Identification	9
Kuhl Q Control Options	10
Control Panel Operation Instructions	11-17
Remote Control Operation	18-19
Electronic Control Sequence of Operation	20-21
Components Testing	22-25
Refrigeration Sequence of Operation	26
R-410A Sealed System Repair Considerations	27
Sealed Refrigeration System Repairs	28-33
Compressor Checks	34-35
Compressor Replacement	36-37
Available Accessories	37
Standard Filter Cleaning/Installation Instructions	38
Routine Maintenance	39-40
After Maintenance/Repair Start-Up Checklist and Notes	41
Performance Test Data Sheet	42
How to Check the Diagnostic Codes	43
Erasing Diagnostic Codes	43
Error Codes	44
Compressor Test Mode	45
Troubleshooting	46-52
Wiring Diagrams	53-54
Thermistor Resistance Values	55
Instructions for using Cooling Load Estimate Form	56
Cooling Load Estimate Form	57
Heat Load Form	58-59
Parts List	60-62
Addendum 1	63
Warranty	64
Parts Depots	65
Technical Assistance	65

IMPORTANT SAFETY INFORMATION

The information contained in this manual is intended for use by a qualified service technician who is familiar with the safety procedures required for installation and repair, and who is equipped with the proper tools and test instruments required to service this product.

Installation or repairs made by unqualified persons can result in subjecting the unqualified person making such repairs as well as the persons being served by the equipment to hazards resulting in injury or electrical shock which can be serious or even fatal.

Safety warnings have been placed throughout this manual to alert you to potential hazards that may be encountered. If you install or perform service on equipment, it is your responsibility to read and obey these warnings to guard against any bodily injury or property damage which may result to you or others.

Your safety and the safety of others are very important.

We have provided many important safety messages in this manual and on your appliance. Always read and obey all safety messages.



This is a Safety Alert symbol.

This symbol alerts you to potential hazards that can kill or hurt you and others.

All safety messages will follow the safety alert symbol with the word "WARNING" or "CAUTION". These words mean:



You can be killed or seriously injured if you do not follow instructions.



You can receive minor or moderate injury if you do not follow instructions.

All safety messages will tell you what the potential hazard is, tell you how to reduce the chance of injury, and tell you what will happen if the instructions are not followed.



A message to alert you of potential property damage will have the word "NOTICE". Potential property damage can occur if instructions are not followed.

PERSONAL INJURY OR DEATH HAZARDS

ELECTRICAL HAZARDS:

- Unplug and/or disconnect all electrical power to the unit before performing inspections, maintenance, or service.
- Make sure to follow proper lockout/tag out procedures.
- Always work in the company of a qualified assistant if possible.
- Capacitors, even when disconnected from the electrical power source, retain an electrical charge potential capable of causing electric shock or electrocution.
- Handle, discharge, and test capacitors according to safe, established, standards, and approved procedures.
- Extreme care, proper judgment, and safety procedures must be exercised if it becomes necessary to test or troubleshoot equipment with the power on to the unit.

- Do not spray or pour water on the return air grille, discharge air grille, evaporator coil, control panel, and sleeve on the room side of the air conditioning unit while cleaning.
- Electrical component malfunction caused by water could result in electric shock or other electrically unsafe conditions when the power is restored and the unit is turned on, even after the exterior is dry.
- Never operate the A/C unit with wet hands.
- Use air conditioner on a single dedicated circuit within the specified amperage rating.
- Use on a properly grounded outlet only.
- Do not remove ground prong of plug.
- Do not cut or modify the power supply cord.
- Do not use extension cords with the unit.
- Follow all safety precautions and use proper and adequate protective safety aids such as: gloves, goggles, clothing, adequately insulated tools, and testing equipment etc.
- Failure to follow proper safety procedures and/or these warnings can result in serious injury or death.

REFRIGERATION SYSTEM HAZARDS:

- Use approved standard refrigerant recovering procedures and equipment to relieve pressure before opening system for repair.
- Do not allow liquid refrigerant to contact skin. Direct contact with liquid refrigerant can result in minor to moderate injury.
- Be extremely careful when using an oxy-acetylene torch. Direct contact with the torch's flame or hot surfaces can cause serious burns.
- Make sure to protect personal and surrounding property with fire proof materials.
- Have a fire extinguisher at hand while using a torch.
- Provide adequate ventilation to vent off toxic fumes, and work with a qualified assistant whenever possible.
- Always use a pressure regulator when using dry nitrogen to test the sealed refrigeration system for leaks, flushing etc.
- Make sure to follow all safety precautions and to use proper protective safety aids such as: gloves, safety glasses, clothing etc.
- Failure to follow proper safety procedures and/or these warnings can result in serious injury or death.

MECHANICAL HAZARDS:

- Extreme care, proper judgment and all safety procedures must be followed when testing, troubleshooting, handling, or working around unit with moving and/or rotating parts.
- Be careful when, handling and working around exposed edges and corners of sleeve, chassis, and other unit components especially the sharp fins of the indoor and outdoor coils.
- Use proper and adequate protective aids such as: gloves, clothing, safety glasses etc.
- Failure to follow proper safety procedures and/or these warnings can result in serious injury or death.

PROPERTY DAMAGE HAZARDS

FIRE DAMAGE HAZARDS:

- Read the Installation/Operation Manual for this air conditioning unit prior to operating.
- Use air conditioner on a single dedicated circuit within the specified amperage rating.
- Connect to a properly grounded outlet only.
- Do not remove ground prong of plug.
- Do not cut or modify the power supply cord.
- Do not use extension cords with the unit.
- Failure to follow these instructions can result in fire and minor to serious property damage.

WATER DAMAGE HAZARDS:

- Improper installation maintenance, or servicing of the air conditioner unit, or not following the above Safety Warnings can result in water damage to personal items or property.
- Insure that the unit has a sufficient pitch to the outside to allow water to drain from the unit.
- Do not drill holes in the bottom of the drain pan or the underside of the unit.
- Failure to follow these instructions can result in result in damage to the unit and/or minor to serious property damage.

INTRODUCTION

This service manual is designed to be used in conjunction with the operation and installation manual provided with each unit.

This service manual was written to assist the professional HVAC service technician to quickly and accurately diagnose and repair any malfunctions of this product.

This manual, therefore, will deal with all subjects in a general nature. (i.e. All text will pertain to all models).

IMPORTANT: It will be necessary for you to accurately identify the unit you are servicing, so you can be certain of a proper diagnosis and repair. (See Unit Identification.)

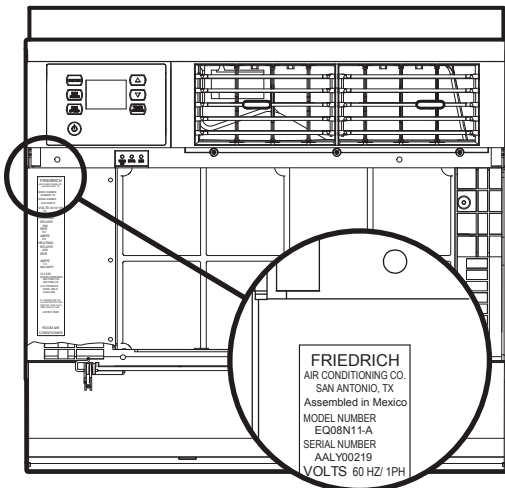

Register your air conditioner

Model information can be found on the name plate behind the front cover.

Please complete and mail the owner registration card furnished with this product, or register online at www.friedrich.com. For your convenience, record the model information here.

MODEL NUMBER

SERIAL NUMBER

PURCHASE DATE

UNIT IDENTIFICATION

KuhlQ Model Number Code

S Q 08 N 1 0 A - A

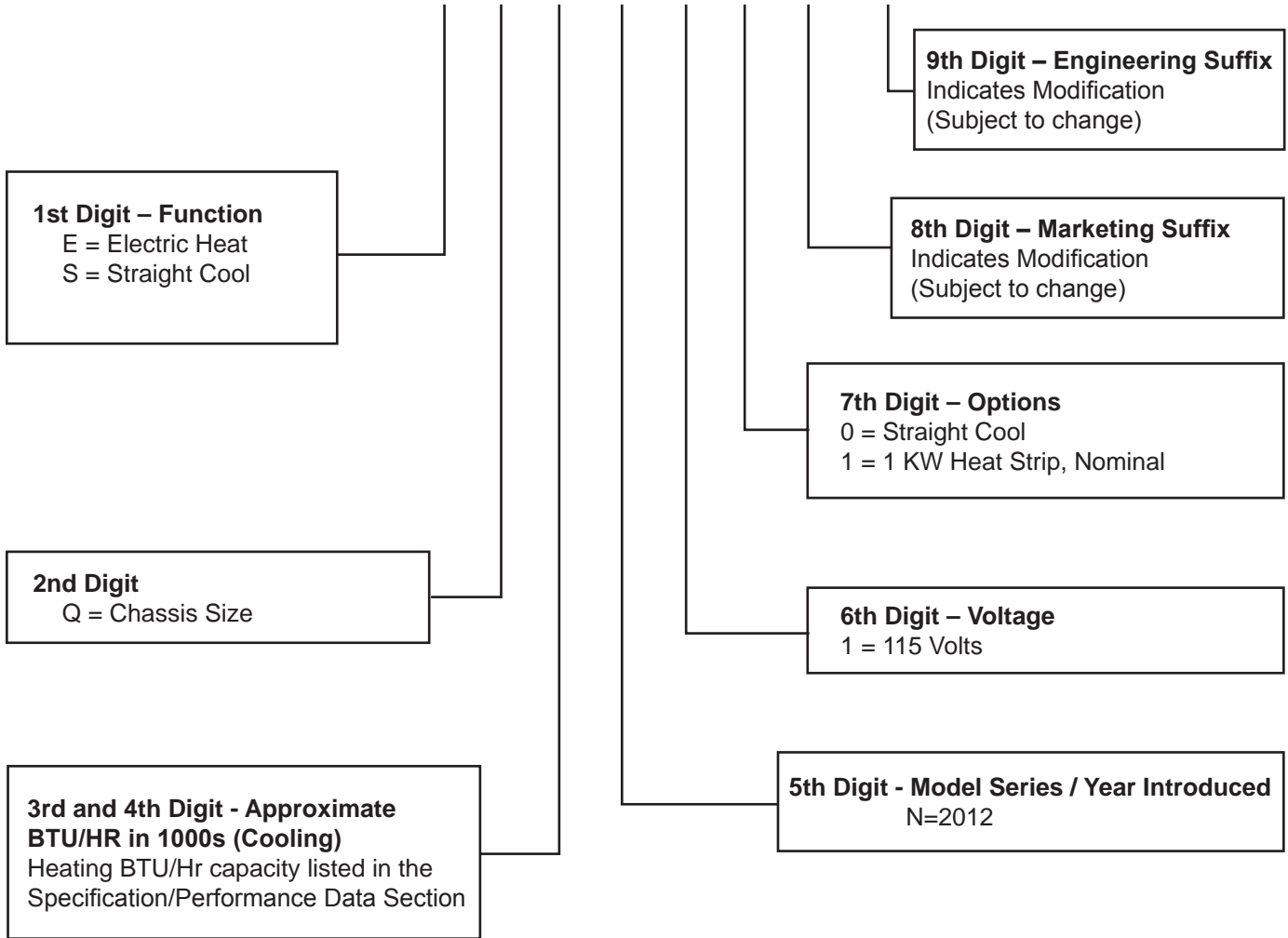

RAC Serial Number Identification Guide

Serial Number Decade Manufactured L=0 C=3 F=6 J=9 A=1 D=4 G=7 B=2 E=5 H=8	A	B	A	Y	00001
Year Manufactured A=1 D=4 G=7 K=0 B=2 E=5 H=8 C=3 F=6 J=9					Production Run Number
Month Manufactured A=Jan D=Apr G=Jul K=Oct B=Feb E=May H=Aug L=Nov C=Mar F=Jun J=Sept M=Dec					Product Line Kuhl Q

PERFORMANCE DATA *

	COOLING PERFORMANCE DATA**	EVAP. AIR TEMP. DEG. F		CONDENSER TEMPERATURE DEG. F	Discharge Temp	Suction Temp	Super Heat	Sub-Cooling	OPERATING PRESSURES		ELECTRICAL RATINGS			R-410A REF.	Voltage	BREAKER FUSE
		Discharge Air	Temp. Drop F.						Suction	Discharge	Amps Cool	Amps Heat	Locked Rotor Amps			
Q-Chassis	SQ05N10-A	57	23	115	146	63	10	13	158	387	9		29.0	17.0	115	15
	SQ06N10-A	57	23	115	146	63	10	13	150	387	4.9		29.0	17.0	115	15
	SQ08N10-A	58	23	118	158	63	12	20	147	415	6.6		32.0	22.0	115	15
	SQ10N10-A	53	22	122	164	58	11	23	136	428	9.2		50.0	23.5	115	15
	EQ08N11-A	53	27	117	159	61	20	19	146	411	6.7	11.2	32.0	18.5	115	15

* Due to continuing research in new energy-saving technology, performance data and 8th and 9th character are subject to change without notice.
 ** Rating Conditions: 80 degrees F, room air temp. & 50% relative humidity, with 95 degree F, outside air temp & 40% relative humidity, all systems use R410A.

Specifications

★ ENERGY STAR® qualified

Model	Cooling Capacity Btu	Heating Capacity Btu	Volts Rated	Cooling Amps	Cooling Watts	Heating Amps	Heating Watts	COP	Energy Efficiency Ratio EER	Estimated Yearly Operating Cost	Moisture Removal Pints/HR	Room Side Air Circulation CFM	Net Weight Sleeve Lbs	Ship Wt
Kühl -														
★ SQ05N10 *	5500	—	115	4.5	514	—	—		10.7	\$41	0,5	190	Q	65 78
★ SQ06N10 *	5900	—	115	4.9	561	—	—		18.7	\$45	0.5	190	Q	71 84
★ SQ08N10 *	7500	—	115	6.1	700	—	—		10.7	\$56	1.2	240	Q	71 84
SQ10N10 *	9500	—	115	8.4	969	—	—		9.8	\$77	2.1	240	Q	75 88
Kühl+ Electric Heat														
EQ08N11*	7500	4000	115	6.9	765	11.2	1290	1.9	11.7	\$61	1.9	175	Q	72 84

*Due to continuing research in new energy-saving technology, specifications are subject to change without notice.

As an ENERGY STAR® partner, Friedrich Air Conditioning Co. has determined that the selected ENERGY STAR® models meet the ENERGY STAR® guidelines for energy efficiency.

The consumer- through the AHAM Room Air Conditioner Certification Program- can be certain that the AHAM Certification Seal accurately states the unit's cooling and heating capacity rating, the amperes and the energy efficiency ratio.

Estimated yearly operating cost based on a 2007 national average electricity cost of 10.65 cents per kWh.

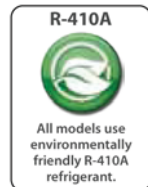

Installation Information / Sleeve Dimensions

Sleeve	Height	Width	Depth with Front	Shell Depth to Louvers	Minimum Extension Into Room*	Minimum Extension Outside*	Window Width		Thru-the-wall Installation Finished Hole		
			A	B			Minimum**	Maximum	Height	Width	Max. Depth C
Q	14"	19 3/4"	21 3/8"	8 1/2"	5 1/2"	10 3/4"	22"	42"	14 1/4"	20"	8 1/2"

* Minimum extensions when mounted in a window.

** Minimum widths achieved using one side curtain assembly as opposed to both in a standard installation.

Circuit Rating / Breaker

Model	Circuit Rating Breaker or T-D Fuse	Plug Face (NEMA#)	Power Cord Length (ft.)	Wall Outlet Appearance
SQ05N10 *, SQ06N10 *, SQ08N10 *, SQ10N10 * EQ08N11 *	125V - 15A	5 - 15P	7 6	

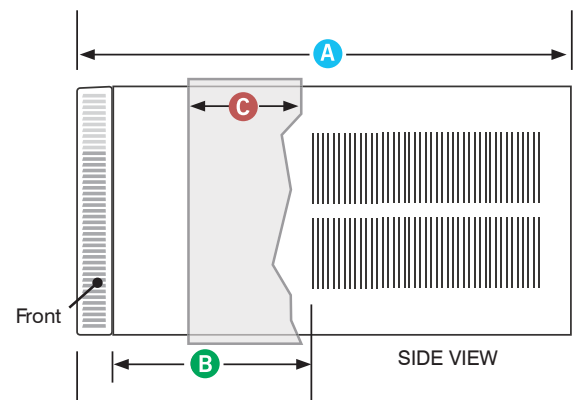

Window Mounting Kits

Heat/Cool Models	Kit No.
EQ08N11*	WIKQ

Friedrich heat/cool models include accessories for thru-the-wall installation only. Window mounting requires use of optional accessory kit as listed above.

ELECTRICAL DATA

⚠ WARNING	
	<p>ELECTRIC SHOCK HAZARD Turn off electric power before service or installation.</p> <p>All electrical connections and wiring MUST be installed by a qualified electrician and conform to the National Electrical Code and all local codes which have jurisdiction.</p> <p>Failure to do so can result in personal injury or death.</p>

NOTICE
<p>FIRE HAZARD</p> <p>Not following the above WARNING could result in fire or electrically unsafe conditions which could cause moderate or serious property damage.</p> <p>Read, understand and follow the above warning.</p>

- | | |
|----------------------|---|
| Wire Size | Use ONLY wiring size recommended for single outlet branch circuit. |
| Fuse/Circuit Breaker | Use ONLY the correct HACR type and size fuse/circuit breaker. Read electrical ratings on unit's rating plate. Proper circuit protection is the responsibility of the homeowner. |
| Grounding | Unit MUST be grounded from branch circuit through service cord to unit, or through separate ground wire provided on permanently connected units. Be sure that branch circuit or general purpose outlet is grounded. |
| Receptacle | The field supplied outlet must match plug on service cord and be within reach of service cord. Do NOT alter the service cord or plug. Do NOT use an extension cord. Refer to the table above for proper receptacle and fuse type. |



The consumer - through the AHAM Room Air Conditioner Certification Program - can be certain that the AHAM Certification Seal accurately states the unit's cooling and heating capacity rating, the amperes and the energy efficiency ratio.



*HACR: Heating Air Conditioning and Refrigeration

WARNING: Before Operating Your Unit

Make sure the wiring is adequate for your unit.

If you have fuses, they should be of the time delay type. Before you install or relocate this unit, be sure that the amperage rating of the circuit breaker or time delay fuse does not exceed the amp rating listed in Table 1.

DO NOT use an extension cord.

The cord provided will carry the proper amount of electrical power to the unit; an extension cord may not.

Make sure that the receptacle is compatible with the air conditioner cord plug provided.

This insures proper grounding. If you have a two prong receptacle you will need to have it replaced with a grounded receptacle by a certified electrician. The grounded receptacle should meet all national and local codes and ordinances. Under no circumstances should you remove the ground prong from the plug. You must use the three prong plug furnished with the air conditioner.

Test the power cord

All Friedrich room air conditioners are shipped from the factory with a Leakage Current Detection Interrupter (LCDI) equipped power cord. The LCDI device meets the UL and NEC requirements for cord connected air conditioners effective August 2004.

To test your power supply cord:

1. Plug power supply cord into a grounded 3 prong outlet.
2. Press RESET (See Figure 1).
3. Press TEST, listen for click; the RESET button trips and pops out.
4. Press and release RESET (Listen for click; RESET button latches and remains in). The power cord is ready for use.

Note: The LCDI device is not intended to be used as an ON/OFF switch.

Once plugged in, the unit will operate normally without the need to reset the LCDI device.

If the LCDI device fails to trip when tested or if the power supply cord is damaged, it must be replaced with a new power supply cord from the manufacturer. Contact our Technical Assistance Line at (800) 541-6645. To expedite service, please have your model number available.

⚠ WARNING



Electrical Shock Hazard

Make sure your electrical receptacle has the same configuration as your air conditioner's plug. If different, consult a Licensed Electrician.

Do not use plug adapters.
Do not use an extension cord.
Do not remove ground prong.

Always plug into a grounded 3 prong outlet.
Failure to follow these instructions can result in death, fire, or electrical shock.

MODEL	CIRCUIT RATING OR TIME DELAY FUSE		REQUIRED WALL RECEPTACLE	
	AMP	VOLT	NEMA NO.	
SQ05 • SQ06 SQ08 • SQ10 EQ08	15	125	5-15P	

Table 1.

Figure 1

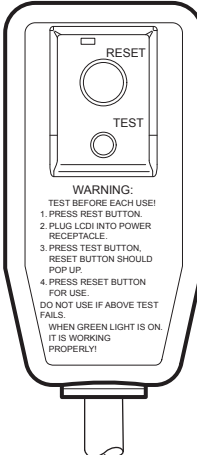

WARNING:
 TEST BEFORE EACH USE!
 1. PRESS RESET BUTTON.
 2. PLUG LCDI INTO POWER RECEPTACLE.
 3. PRESS TEST BUTTON, RESET BUTTON SHOULD POP UP.
 4. PRESS RESET BUTTON FOR USE.
 DO NOT USE IF ABOVE TEST FAILS.
 WHEN GREEN LIGHT IS ON, IT IS WORKING PROPERLY!

For the best cooling performance and highest energy efficiency

Keep the filter clean

Make sure that your air conditioner is always in top performing condition by cleaning the filter regularly.

Provide good air flow

Make sure the airflow to and from the unit is clear. Your air conditioner puts the conditioned air out at the top of the unit, and takes in unconditioned air at the bottom. Airflow is critical to good operation. It is just as important on the outside of the building that the airflow around the unit exterior is not blocked.

Unit placement

If your air conditioner can be placed in a window or wall that is shaded by a tree or another building, the unit will operate even more efficiently. Using drapes or blinds on the sunny side of the dwelling will also add to your unit's efficiency.

Insulation

Good insulation will be a big help in maintaining desirable comfort levels. Doors should have weather stripping. Be sure to caulk around doors and windows.

Proper installation of chassis seal gasket

Make sure the seal gasket has been installed properly to minimize noise and improve efficiency. If the chassis seal gasket has not been installed, please refer to Step 14 of the installation instructions.

Kuhl Q Control Panel Operation

Let's check out how to control your air conditioner. On the control panel, just above the POWER , is a liquid crystal display (LCD). All of the control panel function buttons and mode icons can be viewed in Figure 6.

Power On – Press the button to turn on the air conditioner. The power button illuminates to indicate that the power is on. The backlight on the power switch will automatically dim to 20% intensity after 15 seconds of inactivity. The remote control can also be used to turn power ON / OFF (See Remote Control).

Display – The display is a high efficiency LCD with a built-in white backlight. The backlight has an automatic two (2) step dim function. After 15 seconds of inactivity, the display dims to 20% intensity. After an additional 120 seconds, the display switches off. Touching any button automatically changes the display to full brightness.

There are three control push buttons on each side of the display.

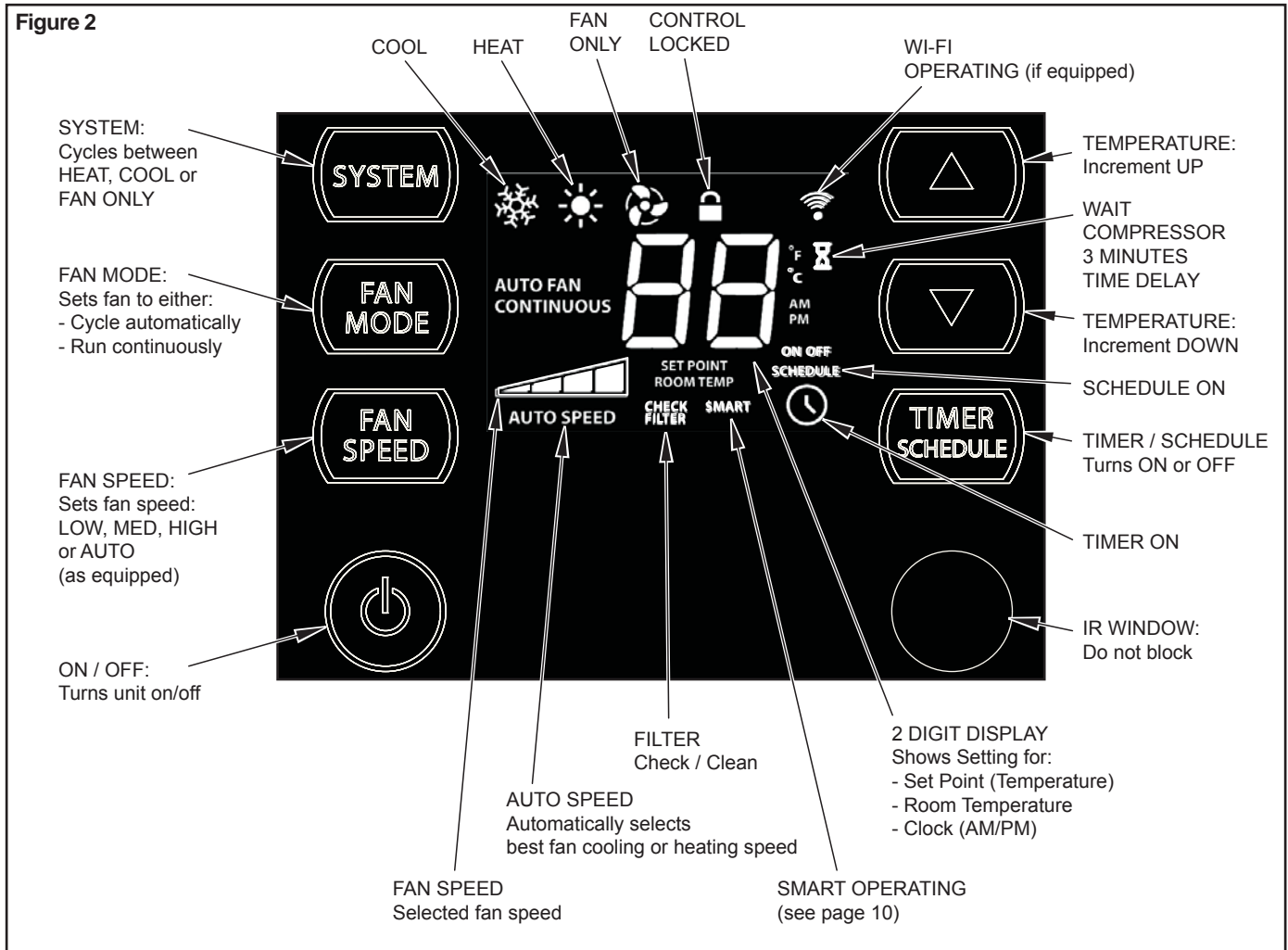

Kühl Control Options

The Kühl gives you a variety of options for control, programming, and scheduling including wireless capabilities

Wireless Programming and Control:

The new FriedrichLink™ Adapter (sold separately) allows you to conveniently control, program and monitor your air conditioning unit remotely from a smartphone or computer.

FriedrichLink™ Adapter accessory available through Friedrich authorized retailers or www.friedrich.com. See FriedrichLink™ Adapter section on www.friedrich.com for complete details.

Pre-Programmed Scheduling Options:

Your unit's digital control comes equipped with a 24-hour timer and two pre-programmed 7-day energy management options.

24-Hour Timer

The 24-hour timer allows you to turn the unit off and on at pre-set times by setting an on and off time on the unit control panel. (See page 11 for details on timer set-up.)

Pre-programmed Energy Management

Your unit comes from the factory with two (2) Pre-programmed Energy Management settings are shown in Addendum 1 (Residential & Commercial Schedule Table).

Energy Management Schedule Options are:

1. Residential Schedule – 40 Hr. Work Week
2. Commercial Schedule – 5-Day Business Week

The "Residential" (40 Hr. Work Week) Schedule has four (4) time periods: 06:00, 08:00, 18:00, and 22:00. This option will cause your Kühl Q unit to raise the room temperature temporarily to 85°F during the hours when most people are away at work, lower them again to 78°F prior to the time when most people will return home, and then raise slightly to 82°F to maintain a comfortable temperature overnight.

The "Commercial" (5-Day Business Week) Schedule has two (2) time periods: 07:00 and 18:00. This option will cause your air conditioner to raise temperatures to 84°F after typical working hours and on weekends when commercial spaces are typically unoccupied.

(See Control Panel Operation Instructions Section)

Customizable Programming Options:

Customizable schedules, with up to four temperature adjustments per day, can either be uploaded to the unit via the air conditioner's built-in micro USB interface or conveniently transmitted wirelessly using the new FriedrichLink™ Adapter accessory, greatly simplifying the programming of one or multiple units. See Figure 7.

See www.friedrich.com for complete Customizable Programming instructions.

Smart Grid

The Kühl Unit is also able to be controlled by a Smart Grid.

Smart Grid is a network that brings electricity from power stations to consumers using new technologies that allow power companies to adjust electrical loads of residential users. Check with your local electric company to learn more about Smart Grid programs in your area.

Figure 3

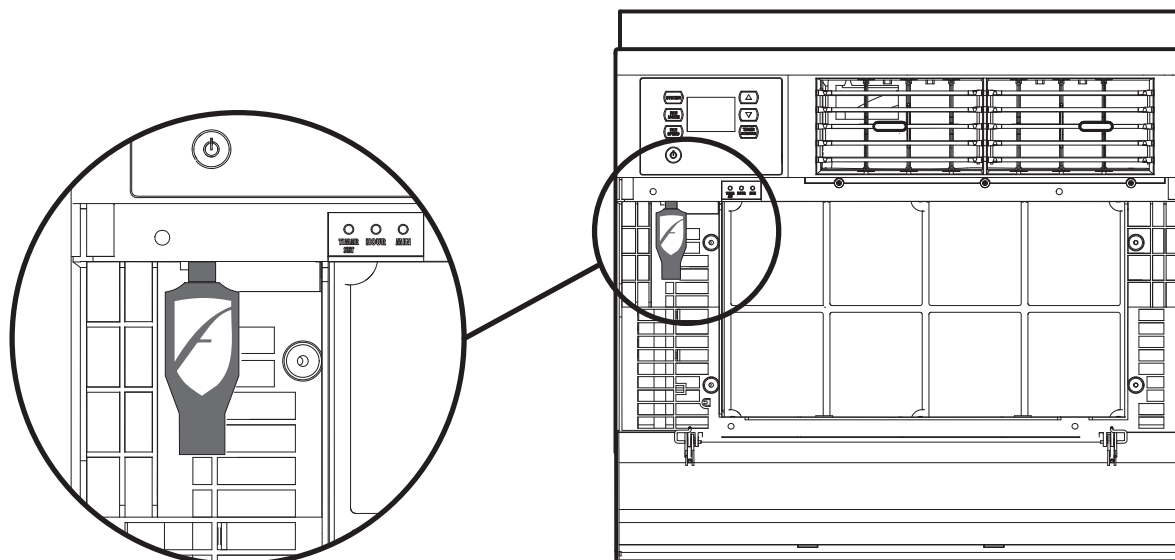



FRR203

Control Panel Operation Instructions

SYSTEM - The **SYSTEM** button allows you to sequentially select three modes of operation. To select, press once and let go.

COOL MODE 

HEAT MODE  Not available on some models

FAN ONLY MODE 

COOL MODE



FRR103

HEAT MODE

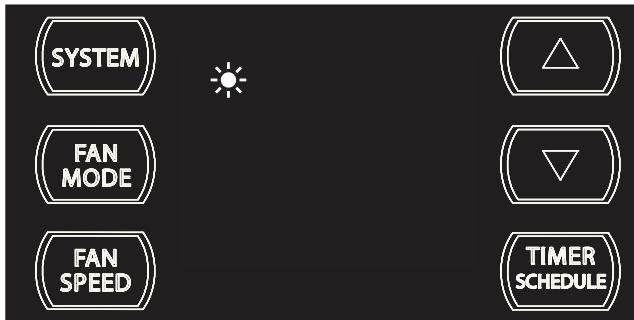





FRR104

FAN ONLY MODE



FRR105

When in the **SYSTEM** COOL  or HEAT  or FAN ONLY  mode, you can also select **FAN MODE**, **FAN SPEED**, **TIMER SCHEDULE**,  and . The **SYSTEM** MODE does not change.

FAN MODE - The **FAN MODE** button allows you to select between **AUTO FAN** and **CONTINUOUS** modes. To select, press once and let go.

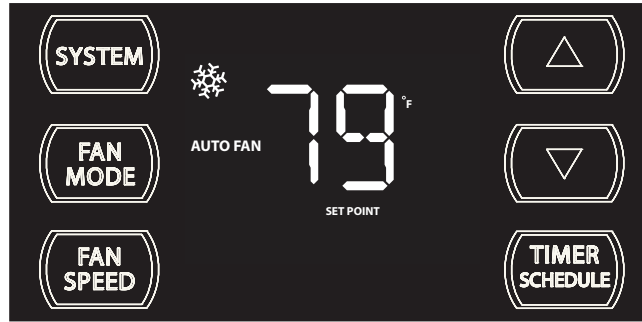

FRR112

When in the **AUTO FAN** mode, the fan operates only when the system has a demand to cool or heat the room. Note: the fan is off (no fan speed icon), indicating no command for cooling or heating.

AUTO FAN (Cooling Demand)

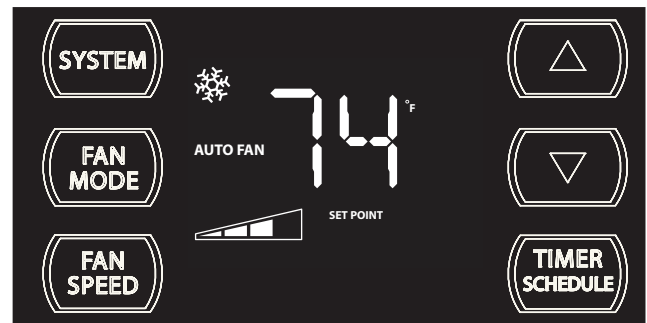

FRR106

System has a demand for cooling. The fan is operating at a medium speed.

CONTINUOUS

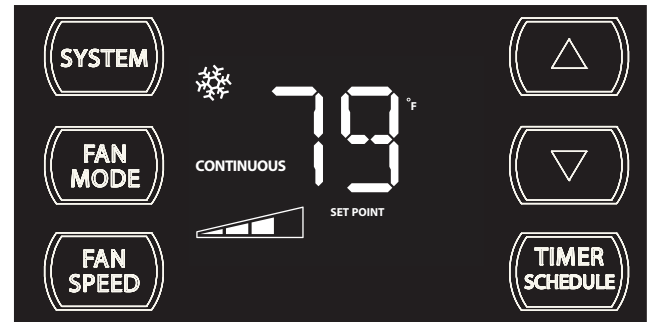

FRR113

In the **CONTINUOUS** fan mode, the fan operates all the time. The system periodically cools or heats the fan's air flow but the flow of air does not stop.

FAN SPEED - The **FAN SPEED** button allows you to toggle between four modes of operation: **LOW**, **MEDIUM**, **HIGH** and **AUTO**. Press once and let go each time.



FRR095

During the (**SYSTEM** mode COOL or HEAT), the fan speed automatically varies depending on the difference between the unit's set point on the control panel and the actual room temperature. Let me explain. Say for example, you're working in your garage and you open the big door for several minutes. The system will sense a wide difference between the set point and the actual room temperature. When this occurs, the system fan speed increases to **HIGH** for a period of time. The fan speed decreases, in step, as the temperature difference decreases. When the room temperature matches the system's set point, fan speed returns to the lowest setting, and if the fan mode is on **AUTO FAN**, the fan will stop.

UP ▲ and DOWN ▼ - arrows - Pressing either ▲ or ▼ button changes the system's set point (desired room temperature). These buttons are also used for setting the Timer and other programming.

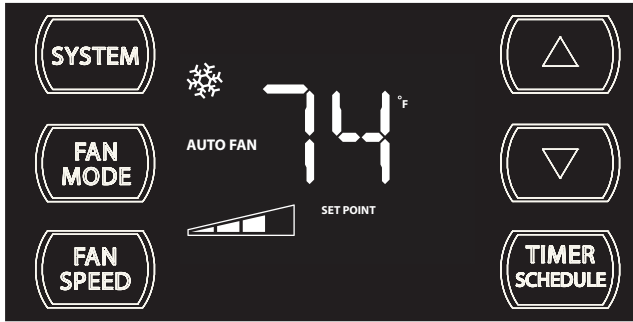

FRR100



FRR101

One press equals 1 degree of change. Holding the button down for more than 0.6 seconds starts the fast increment/decrement change of the set point.

TIMER SCHEDULE BUTTON -

The **TIMER SCHEDULE** button has two main uses:

1. Used to preselect a **TIMER** or **SCHEDULE** function. (For pre-selection instructions, please see page 14.)
2. Used to turn on or activate the pre-selected **TIMER** or **SCHEDULE**.
3. To turn on your pre-selection, press the **TIMER SCHEDULE** button once and let go. The display at bottom right will show the **TIMER** or **SCHEDULE** icon.

Example:

TIMER is turned ON



SCHEDULE is turned ON



TIMER (FACTORY DEFAULT) - The **TIMER** is the default on new units. The **TIMER** function allows you to turn the unit one time ON and one time OFF daily at the times that you select. For example, you can command the system to turn ON at 8:15 am and to turn OFF at 1:30 pm everyday. (To set the timer, see pages 15 -16.)

SCHEDULE - The **SCHEDULE** has two options with factory pre-programmed energy management settings: temperature, system and time settings (see addendum) (for more information, see page 14).

Schedule options are:

1. Residential Schedule - 40 hour work week
2. Commercial Schedule - 5 day business week
(These factory pre-programmed settings can only be changed by using the WiFi FriedrichLink™ adaptor, with which you can create your own custom program. See page 10.)

°F - °C Select

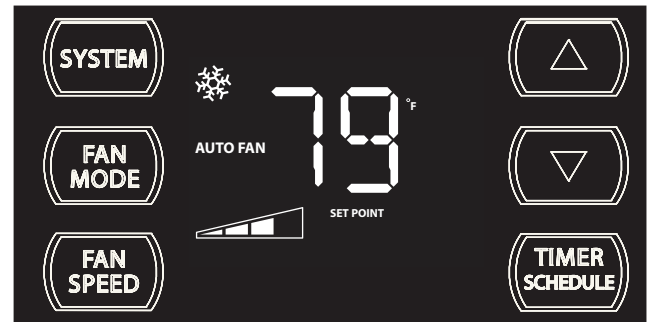

FRR132

To switch from degrees Fahrenheit (F) to Celsius (C), press ▲ and ▼ buttons simultaneously for three seconds.



FRR133

An "F" will flash for 5 seconds and then revert to a normal display. To change from F to C, press the ▲ or ▼ button within 5 seconds.



FRR134

A "C" will flash for 5 seconds and then revert to a normal display.



FRR135

The °F icon goes away and the °C icon illuminates on the normal display.

DIM Function

There are three separate display brightness levels, AUTO, 20% and full (100%). To change the DIM setting, press the Power button for three seconds.

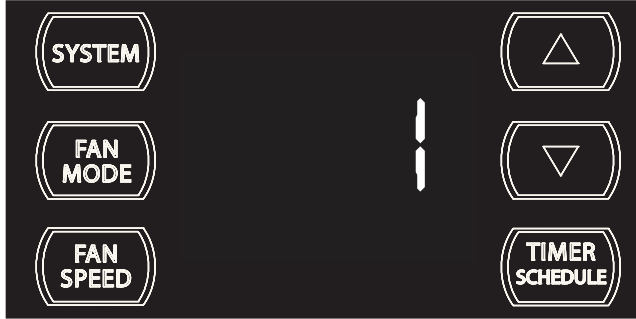

FRR192

The 1 indicates a DIM setting of Auto (factory default on new units). Use the ▲ or ▼ buttons to change the setting.



FRR193

The 2 indicates a DIM setting of 20%. Press the TIMER SET button within 15 seconds to save the setting. Button inactivity for more than 15 seconds causes the display to time out and return to the normal operating display.



FRR194

The 3 indicates a DIM setting of 100% (full brightness). Press the TIMER SET (Refer to Figure 8) button within 15 seconds to save the setting. Button inactivity for more than 15 seconds causes the display to time out and return to the normal operating display.

Alerts

When the filter needs to be cleaned or replaced, the **CHECK FILTER** icon displays.

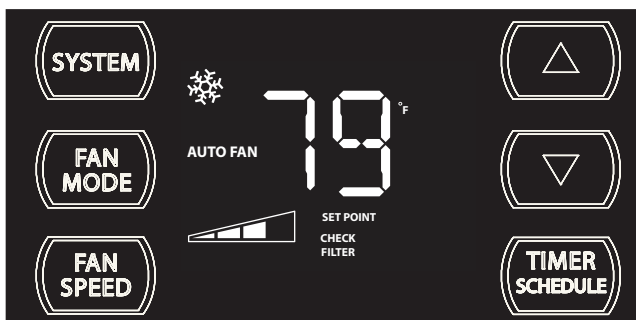

FRR118

The alert can be dismissed by pressing the **FAN MODE** and **TIMER SCHEDULE** for 3 seconds.

Wait Icon

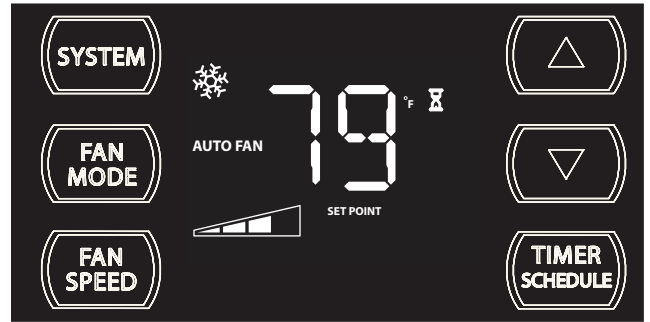

FRR120

The wait icon **⏸** illuminates when the compressor lockout is active.

Control Panel Lock

To lock the front panel controls, press and hold the **FAN SPEED** + **TIMER SCHEDULE** buttons for 3 seconds. The lock icon **🔒** illuminates to indicate the locked status. During lockout, none of the control panel buttons will operate.

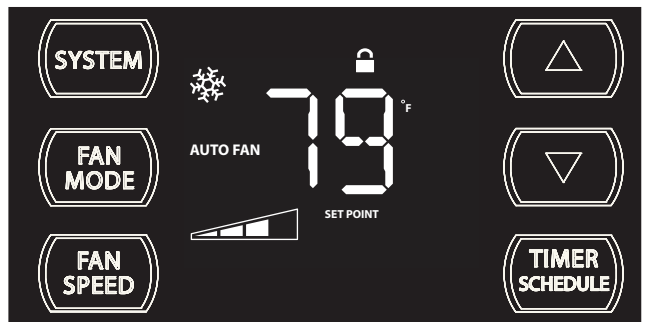

FRR116

To unlock, press and hold the **FAN SPEED** + **TIMER SCHEDULE** buttons simultaneously for 3 seconds.

External Control Status

The **SMART** icon illuminates to indicate that the system is being controlled remotely, such as from a smart grid from a power company (for more information, see page 12).

SMART

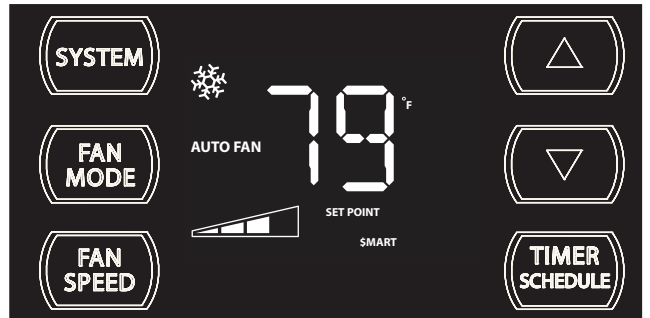

FRR125

WiFi Connection



FRR126

The **WiFi** icon illuminates to indicate that the system is receiving a Wi-Fi connection (for more information, see page 10).

TIMER OR SCHEDULE OPTIONS 1 OR 2 SELECTION

The control system has one Timer and two Schedule functions:

- A. **Timer (factory default)** - Allows you to command the unit to turn ON and OFF at a time you program. Setting the start, stop and day can be found later in this manual on page 15.
- B. **Residential Schedule** - When selection #1 is selected, the unit follows a pre-programmed set of operational parameters that covers 7 days of the week with 4 time windows during each day. Each time window has its own set of 8 operating parameters. Refer to Addendum 1.
- C. **Commercial Schedule** - When selection #2 is selected, the unit follows a pre-programmed set of operational parameters that covers 7 days of the week with 2 time windows during each day. Each time window has its own set of 8 operating parameters. Refer to Addendum 1.

To change the TIMER/SCHEDULE selection, press and hold the  button for 3 sec, then let go.

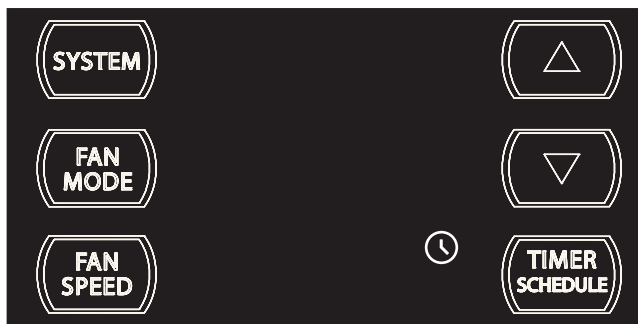

FRR139

The display shows the TIMER is selected. Press the  button once and let go.

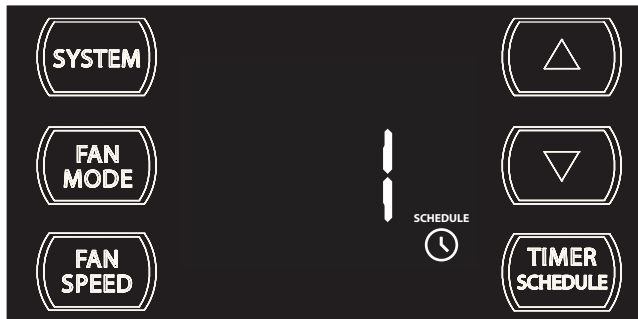

FRR137

The display shows option 1 (Residential Schedule) is selected. Press the  button once and let go.

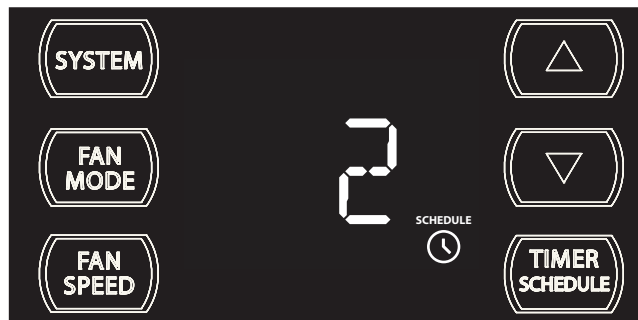

FRR138

The display shows option 2 (Commercial Schedule) is selected.

To save and exit selection, press the TIMER SET button (Figure 4, Page 15).

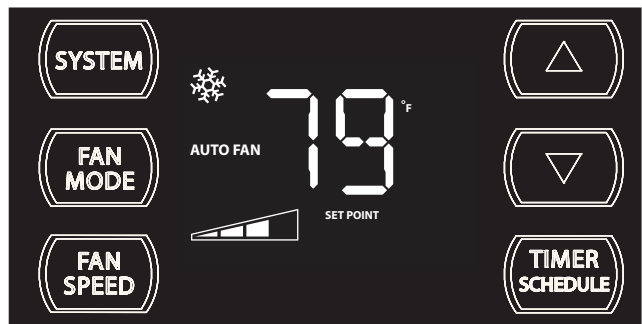

FRR136

The display reverts to the normal display.

NOTE: The schedule options 1 and 2 have factory pre-programmed settings which can only be changed by using the WiFi FriedrichLink™ adaptor (an accessory). With it, you can create your own custom schedule program. See page 10 for more information.

NOTE: Once you have selected the TIMER  you must first set the following before turning it on.

1. Set time and day
2. Set start time
3. Set stop time

See timer settings on next page.

To Turn On the Timer or Schedule Selected

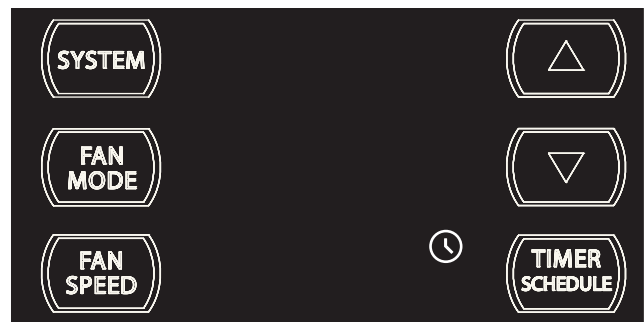

FRR139

Press the  button and let go. The system will operate in the mode mode option (1, 2 or Timer) you selected. At the above image, TIMER is selected and turned on.

TIMER SETTINGS

1. Set time and day
2. Set start time
3. Set stop time

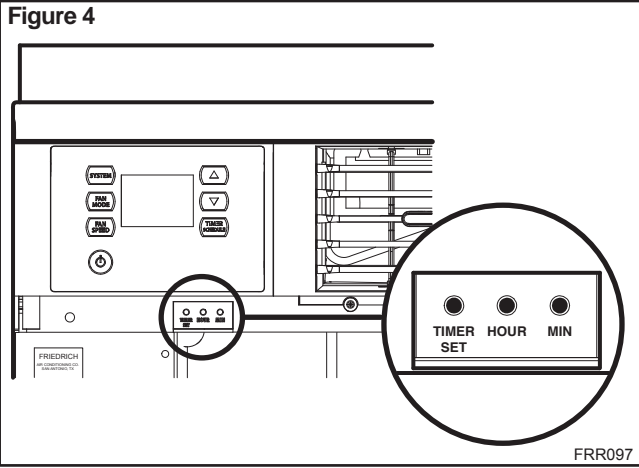

SET TIME AND DAY - To adjust the unit's time press and hold the HOUR and the MIN buttons for three seconds (Refer to Figure 4).

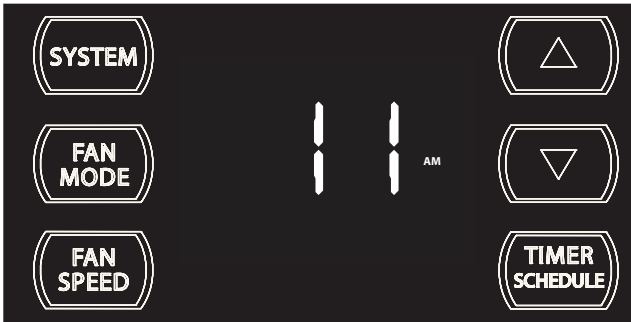

The unit's current hour displays. Use the ▲ or ▼ buttons to adjust the hour. To change from AM to PM continue to increment (roll) the display. Press TIMER SET (Refer to Figure 4) button to save the hour and display the unit's current minutes.



Use the ▲ or ▼ buttons to adjust the minutes. The clock is now set for 11:25 AM. Press TIMER SET (Refer to Figure 4) button to display the unit's day setting.



Use the ▲ or ▼ buttons to adjust the day (1 to 7). The day setting is up to the user. If you set the current day = 1. So if today is Tuesday, then Day 1 = Tuesday, select 1.

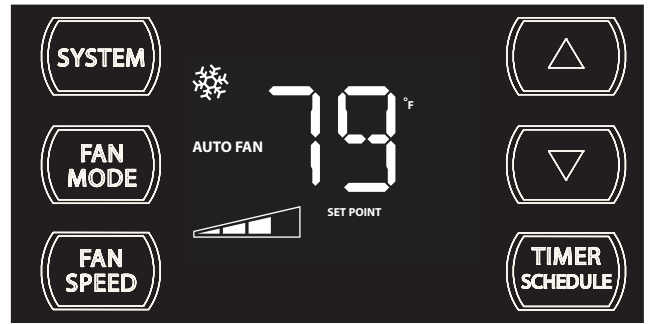

Press TIMER SET (Refer to Figure 4) button to exit and save the SET TIME function. The TIMER SET button must be pressed within 15 second. Button inactivity for more than 15 seconds causes the display to time out and return to the normal operating display.

Timer Start Time

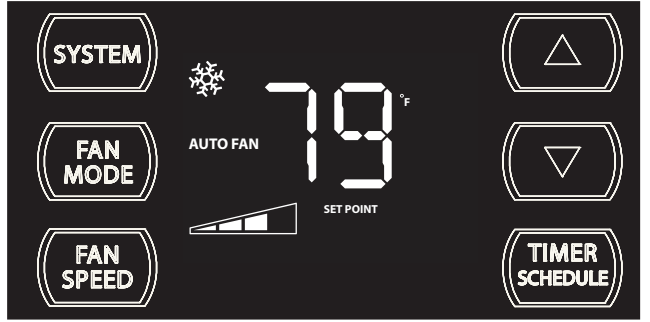

The display shows a normal system. Press and hold the HOUR button (Figure 4) for 3 seconds. Note: The Timer start-stop times may be set even when the system is in the Timer or Schedule mode.

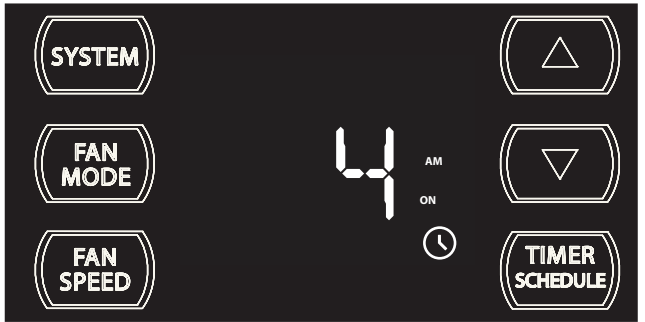

Use the ▲ or ▼ button to adjust the hour. Press the TIMER SET button (Figure 4) to adjust the minutes.

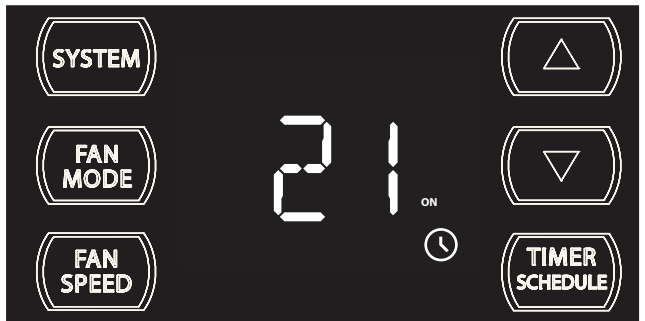

Use the ▲ or ▼ button to adjust the minutes. Press the TIMER SET button (Figure 4) within 15 seconds to exit and save the setting. The timer is now set to start at 4:21 AM.

The display will return to normal.

Set the Timer Stop Time

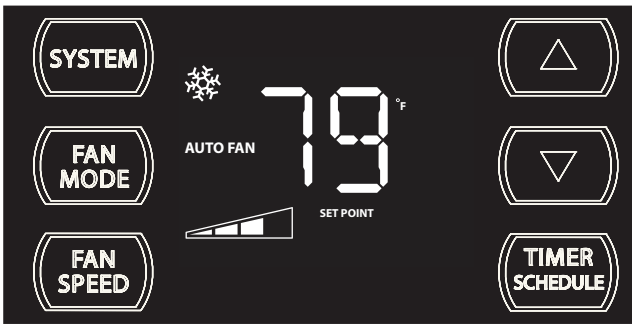

FRR144

The display shows a normal system. Press and hold the MIN button (Figure 4) for 3 seconds. Note the Timer start - stop times may be set even when the system is in the Schedule mode.

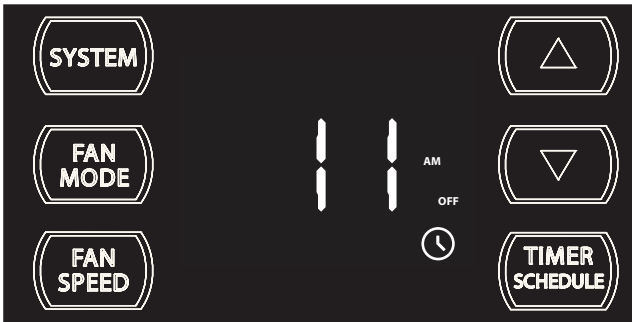

FRR145

Use the ▲ or ▼ button to adjust the hour. Press the TIMER SET button (Figure 4) to advance to the Minutes section.

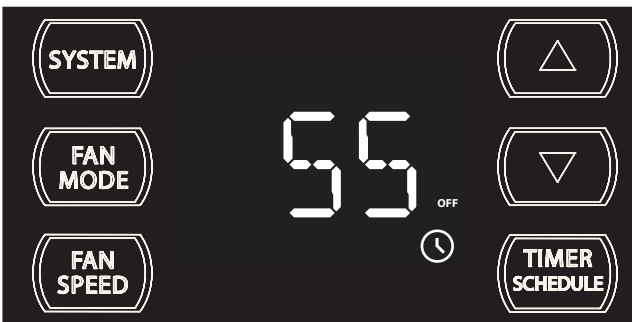

FRR146

Use the ▲ or ▼ button to adjust the minutes. Press the TIMER SET button (Figure 4) within 15 seconds to exit and save the setting. The timer is now set to stop at 11:55 AM. The display returns to normal.

Turning the TIMER ON once the time and day, the start and stop times have been set:

Press the  button once and let go.

NOTE: See the following TIMER  ON/OFF scenarios.

Timer ON Scenarios

Scenario 1

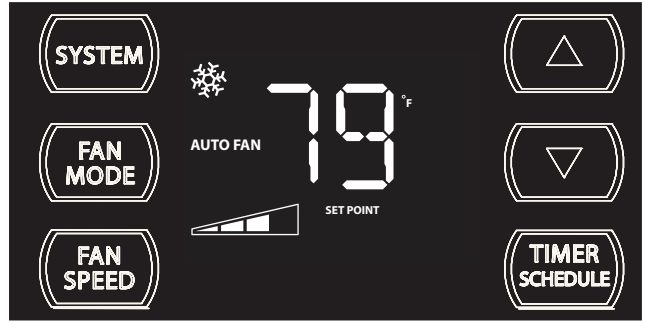

FRR156

The display shows a normal operating system.

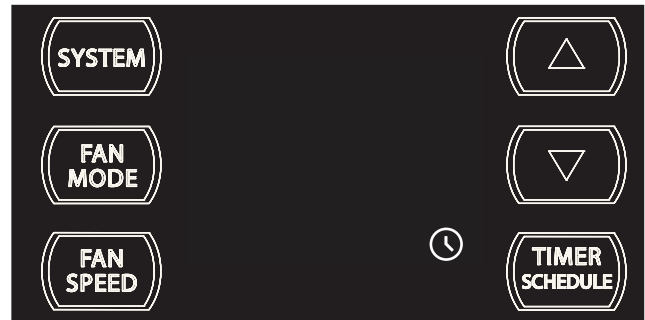

FRR157

If the Timer function is turned ON during the Timer's OFF time, the  icon illuminates. The control system immediately turns the unit OFF.

Scenario 2

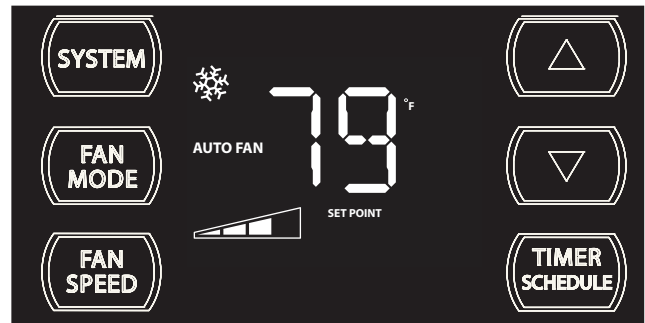

FRR158

The display shows a normal operating system.



FRR159

If the Timer function is turned ON during the Timer's ON time, the  icon illuminates. The control system immediately turns the unit OFF.

Timer OFF Scenarios

Scenario 1



FRR166

The display shows the unit in Timer mode during an in-active (OFF) period.

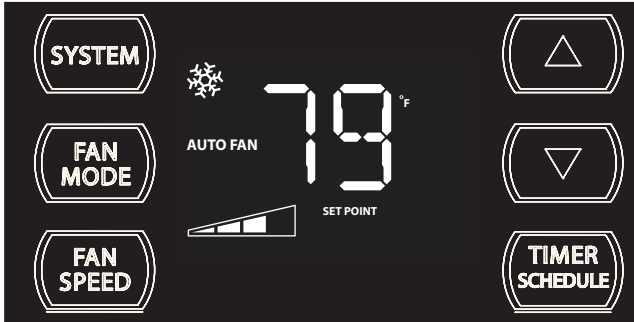

FRR167

If the Timer function is turned OFF during an in-active (OFF) period, the Timer icon turns off. The display shows a normal system.

Scenario 2

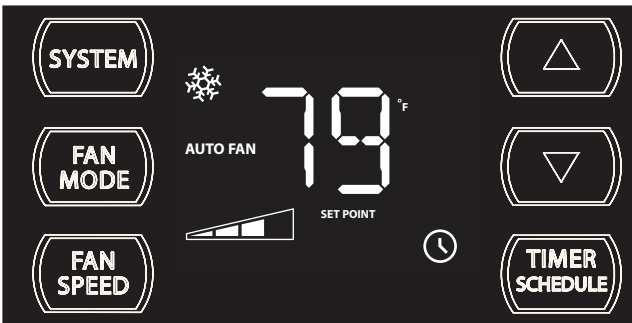

FRR168

The display shows the unit in Timer mode during an active (ON) period.

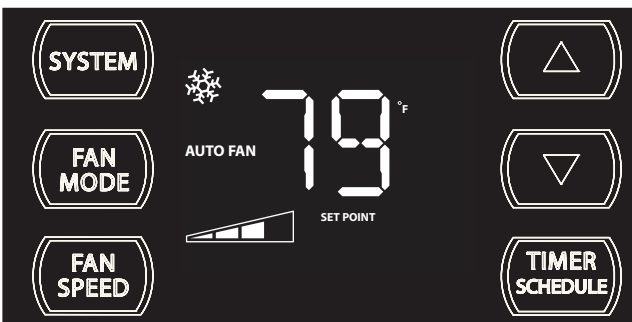

FRR169

If the Timer function is turned OFF during the ON time. The Timer icon turns off. The control stays in the current state.

The display shows a normal system.

Timer - Schedule Control Block

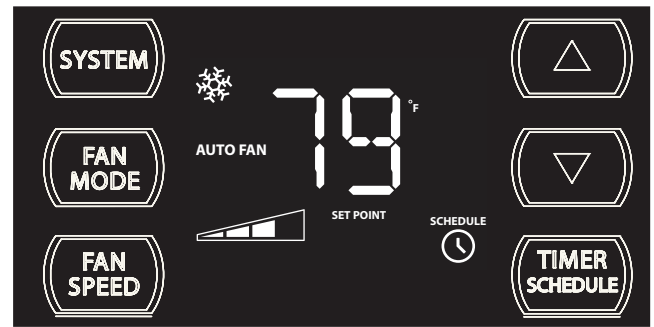

FRR148

If the unit is operating in the TIMER or SCHEDULE mode, and you press any button except the **TIMER SCHEDULE** button, the TIMER icon begins to blink. All button action is blocked.

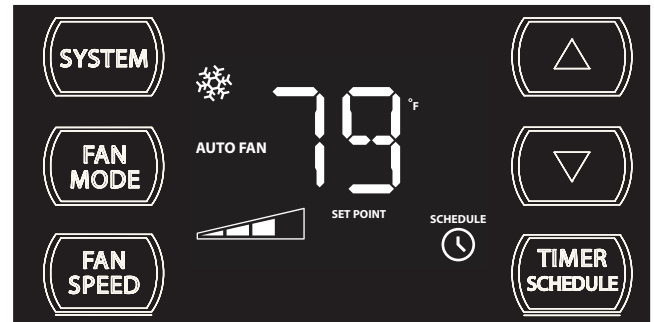

FRR149

The TIMER icon stops blinking after 3 seconds. You must turn the active TIMER or SCHEDULE mode OFF before making changes. Once the changes are made, press the **TIMER SCHEDULE** button to re-activate TIMER or SCHEDULE mode.

If the unit is operating in the TIMER or SCHEDULE mode, and then you press any button except the **TIMER SCHEDULE** button, the TIMER icon begins to blink.

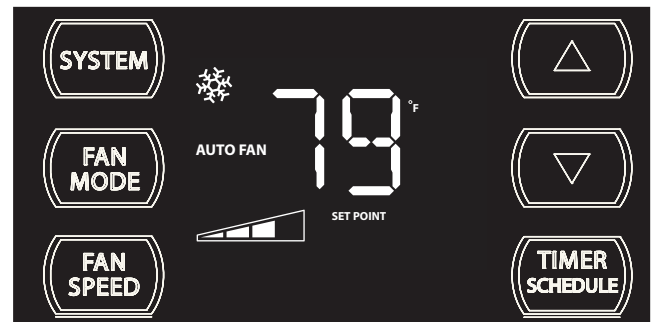

FRR150

All button action is blocked.



Remote Control Operation

Remote Control - Refer to Figures 10 and 11 during operation description.

Getting Started - Install two (2) AAA batteries in the battery compartment located on the back of the unit.

Operation - The remote control should be within 25 feet of the air conditioner for operation. (Refer to Figure 9 for effectiveness). Press the power button to turn the remote on. The remote will automatically power off after 15 seconds if the buttons are not being pressed. The remote must be on to control the unit.

POWER Button - Turns remote and unit on and off.

SYSTEM Button - Allows the user to sequentially select, Cool , HEAT  and FAN ONLY  operation. When the button is pressed, the display indicates which mode has been selected via a display message. Note that when the heating function is not available, the system will automatically skip the HEAT mode.

FAN MODE Button - Selects between automatic (AUTO FAN) or CONTINUOUS operation. In the AUTO FAN mode, the fan only turns on and off when the compressor operates or the heat function is active.

NOTE: AUTO FAN is not available in the FAN ONLY Mode, the display indicates CONTINUOUS. In the CONTINUOUS mode, fan speed is determined by your selection on the FAN SPEED button.

FAN SPEED Button - Used to sequentially select new fan speed, plus AUTO operation. When the FAN SPEED button is pressed, the fan speed icon (triangle) changes to indicate the new speed level. Fan speed automatically varies depending on the set temperature on the control panel and the actual room temperature. For example if there is a big difference between your set temperature and the actual room temperature, the system fan speed increases to HIGH. It remains at this speed until the room temperature matches the set temperature.

TIMER/SCHEDULE Button - The TIMER/SCHEDULE button turns the schedule function on and off. Press the SCHEDULE button once to turn on the Schedule (Residential, Commercial, Timer or Customized. that has already been pre-programmed into your unit. Pressing the SCHEDULE button a second time turns the schedule function off.

UP and DOWN Arrows - Pressing either the UP (UP) or DOWN (DOWN) button changes the desired room temperature. The factory preset lower and upper limits are 60°F (16°C) and 99°F (37°C). These buttons are also used to navigate between function options when using the User Menu or Maintenance Mode.

Remote Effectiveness

Hand Held Remote - Has an operating range of up to 25 ft. The infrared remote control signal must have a clear path to transmit the command to the air conditioning unit. The remote signal has some ability to "bounce" off of walls and furniture similar to a television remote control. The diagram below shows the typical operating range of the control in a standard room with 8 ft high ceilings.

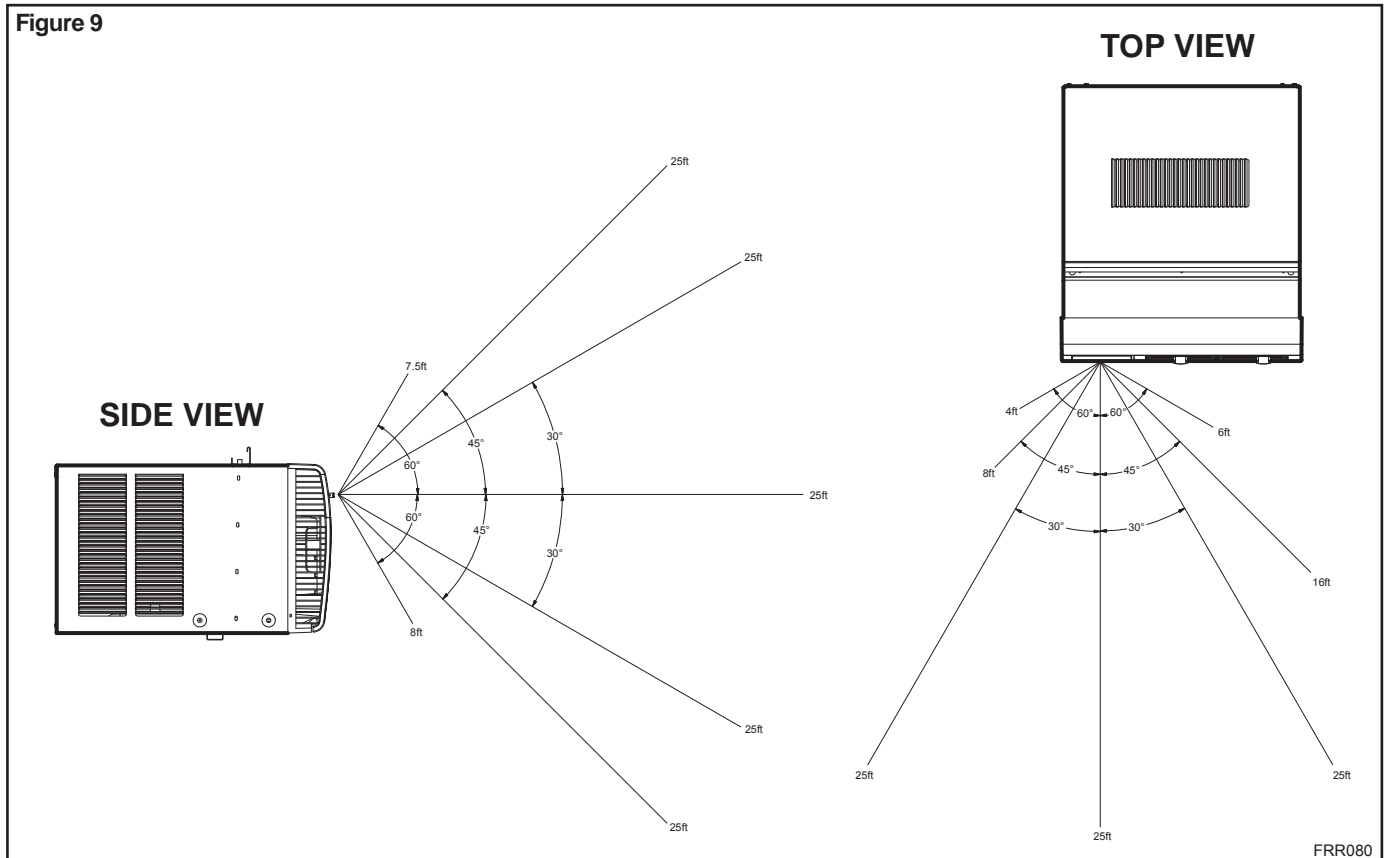
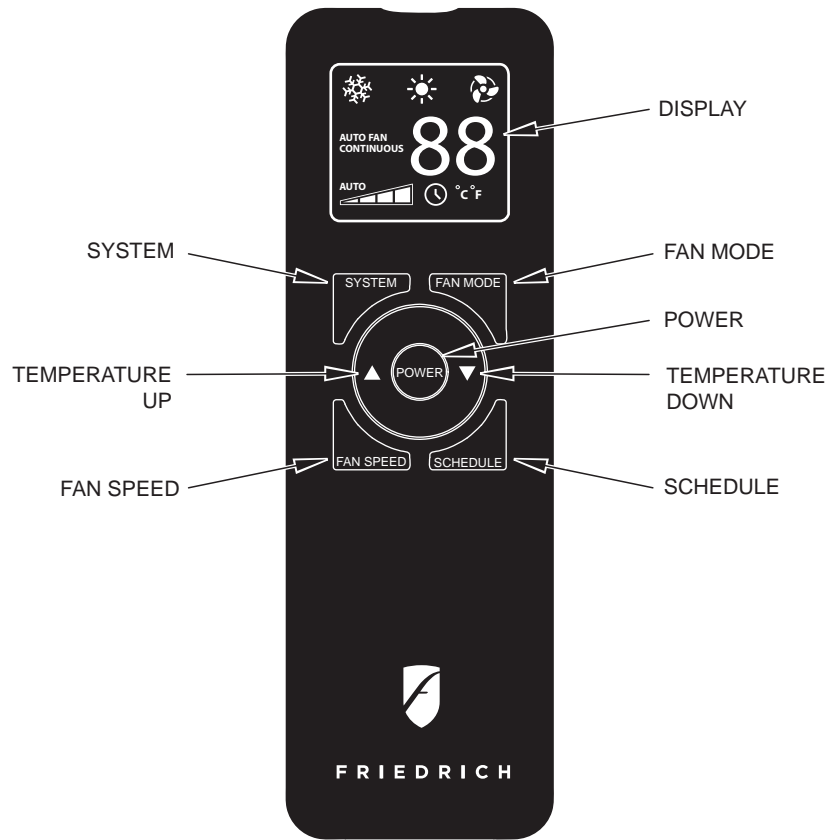
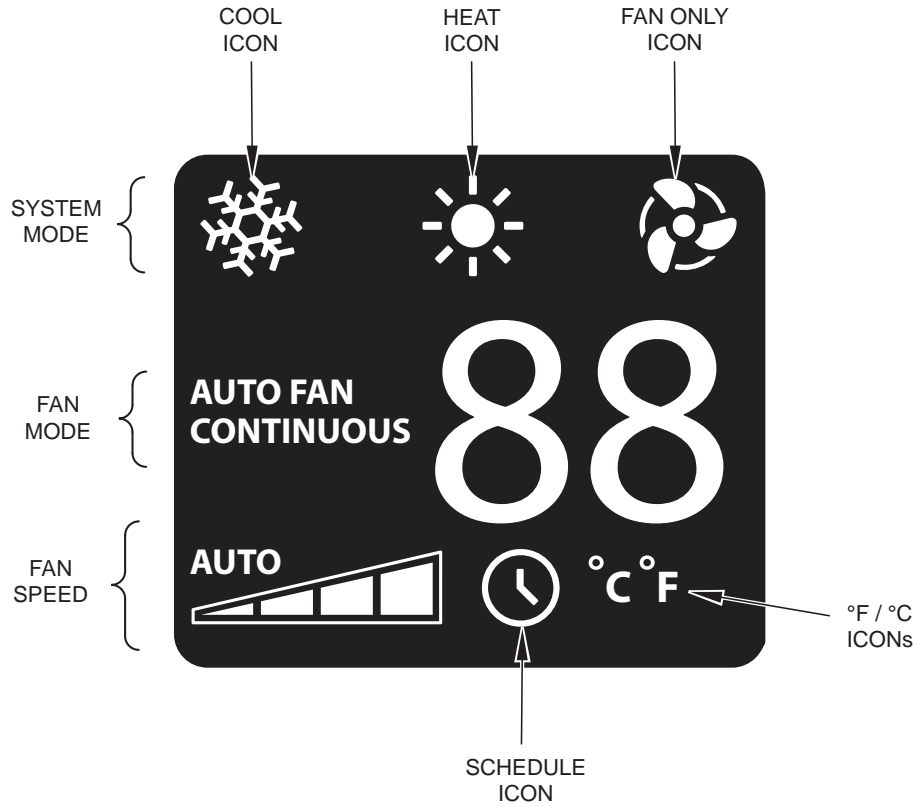

Figure 10



FRR081

Figure 11



FRR082

ELECTRONIC CONTROL SEQUENCE OF OPERATION

Cooling Mode

Once the ambient temperature rises past the cool demand threshold (Cool Set Point + 1.5 °F) (see figure below), and the compressor is not locked out, the cooling cycle begins. As shown in the figure below, the fan is started 5 seconds prior to the compressor. Once the ambient temperature has been lowered to .25 °F below the set point, the cooling cycle starts to terminate by shutting off the compressor. After a 30 seconds delay, the fan is shut off.

(See figure below for graphic details)

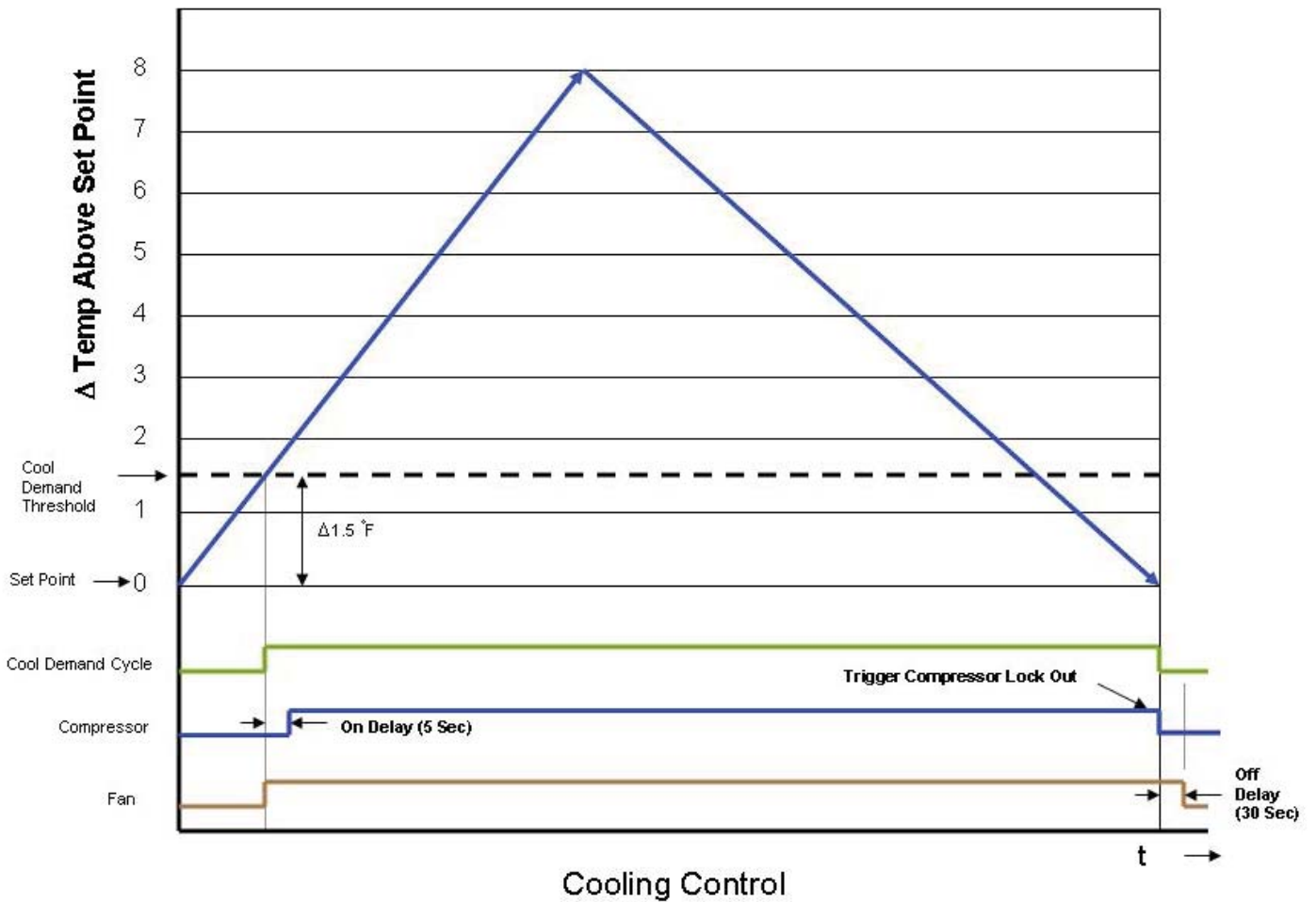

Electric Heat Operation in Cool with Electric Heat Units

When in the Heat mode, with and without Fan Mode Auto (Fan cycling):

If the indoor ambient temperature is below the Heat Demand Threshold (Heat Set Point minus 1.5 °F), turn on electric heat.

If Ambient is 0.3 °F above the Heat Set Point turn off the electric heat.

ELECTRONIC CONTROL SEQUENCE OF OPERATION (CONT.)

Compressor Lock Out Time

The lockout feature ensures that the compressor is de-energized for a period of time. The timer varies randomly from 180 to 240 seconds

The compressor lockout is initiated every time the compressor is "off" due to:

- (1) Satisfying the temperature set point
- (2) Changing mode to fan only or heat
- (3) Turning the unit off
- (4) Control is first plugged in or power is restored after failure
- (5) Line power is restored from a brown out condition

Wait ICON (Hour Glass ☒)

The wait icon will be turned on when the compressor is locked out and during demand for cooling or heat pump compressor operation. The Wait ICON will be turned off when the condition clears.

Cooling Fan Delay

Fan cycle/Auto mode only

When unit cycles cooling ON – starts the fan 5 seconds EARLY. When unit cycles cooling OFF – DELAYS the fan off for 30 seconds

Note: this fan delay is disabled during Test Mode

Heating Fan Delay

This is only for fan Mode Auto (Fan cycles with cool/heat operation) and not for continuous fan mode. When unit cycles Heating ON – starts the fan 5 seconds EARLY. When unit cycles Heating OFF – DELAYS the fan off for 15 seconds

Note: the fan delay is disabled during Test Mode

Fan Speed Change Delay

Relay activation is delayed by a minimum number of seconds. The default for this value is 2 seconds and is used to eliminate relay chatter.

Fan Only System Mode

The fan is turned on and runs at the specified manually set speed.

Only the Fan is turned on. Cool or Heat operation are off.

(This is different than FAN MODE CONTINUOUS where the fan is on with the cool or heat operation).

Fan Only Rules

1. If the SYSTEM FAN ONLY MODE is selected, the Auto fan mode is disabled, and the fan mode is forced to continuous. In addition, the auto fan speed is disabled. If the user presses the fan speed key, the menu will skip over the auto selection. The set point temperature display is off.
2. Any fan speed may be manually selected during Fan Only Mode.

COMPONENTS TESTING

Testing the User Interface and Relay Board

⚠ WARNING	
	ELECTRIC SHOCK HAZARD Turn off electric power before inspections, maintenances, or service.
	Extreme care must be used, if it becomes necessary to work on equipment with power applied.
	Failure to do so could result in serious injury or death.

If the user interface does not turn on:

1. Unplug unit, remove the User Interface.
2. Replug power cord and make sure the unit has the proper voltage and that it is turned on.
3. Reconnect the user interface's wire harness. (Ensure it is in good condition.)
4. Using a voltmeter, check for 5VDC at plug - see Image #2 and #3.
5. For room temperature thermistor's voltage test, see Image #2.

User Interface Tests

Front



Image 1

Room Temperature Thermistor Voltage Test

Ensure there is 5 VDC at User Interface (see Image 3).

Back



Image 2

Check here for 3.3VDC. If no voltage or wrong voltage, replace the User Interface.



Not used.

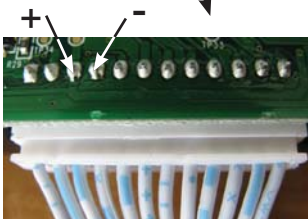

Image 3

User Interface Voltage Test

Check here for 5VDC. If no voltage or wrong voltage, replace relay board. If voltage is OK, replace User Interface.

Relay Board Test

Front



Image 4

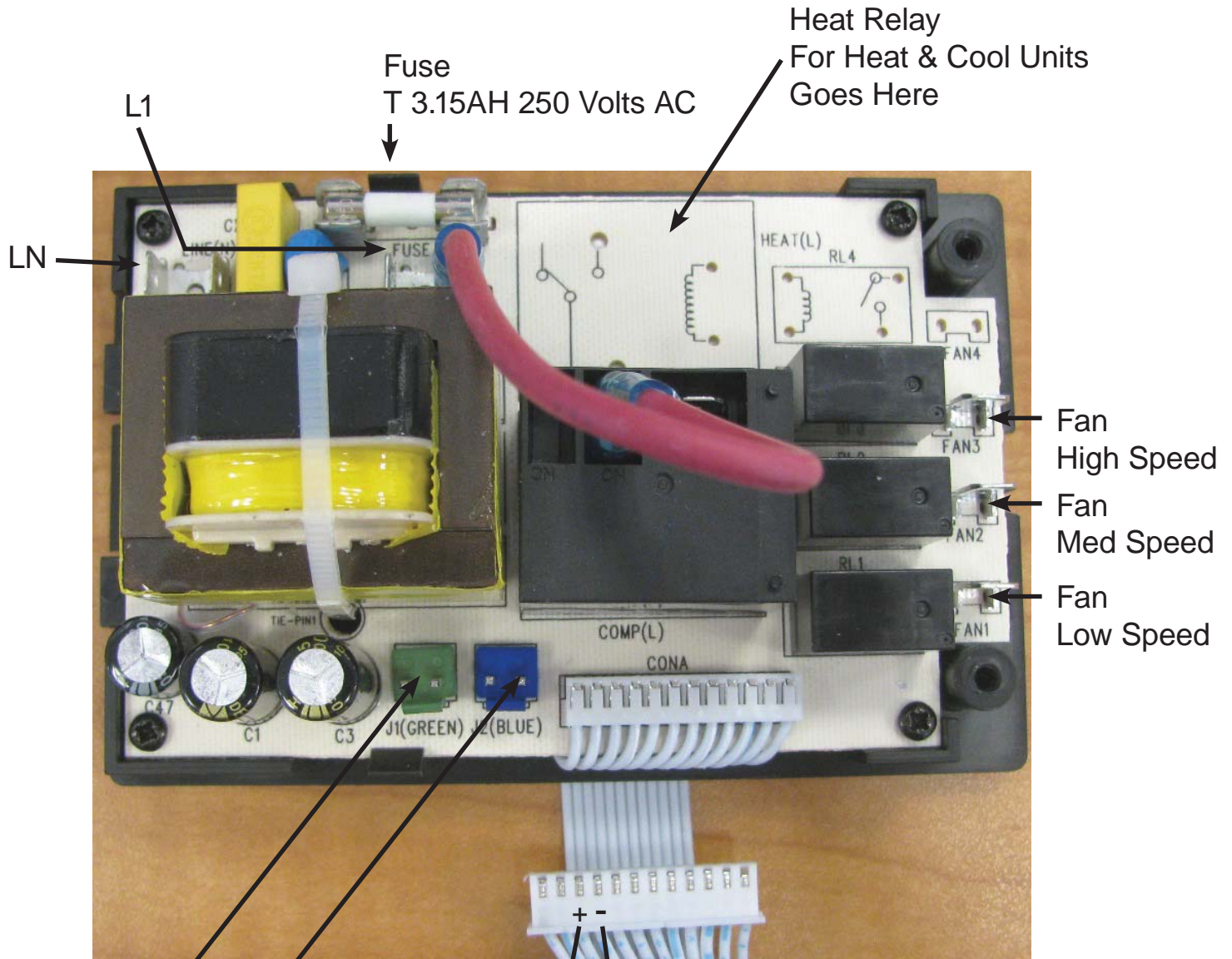

Image 5

Test for 5VDC. If no voltage or wrong voltage, replace relay board.

COMPONENTS TESTING (CON'T)

Testing the Relay Board



Indoor Coil Thermistor
Outdoor Coil Thermistor

Test here for 5VDC. If no voltage or wrong voltage, replace relay board.

Test for 3.3VDC. If incorrect or no voltage, replace electronic relay board. If voltage OK, check thermistor's resistance value (See page 56).

COMPONENTS TESTING (Continued)

FAN MOTOR

A single phase permanent split capacitor motor is used to drive the evaporator blower and condenser fan. A self-resetting overload is located inside the motor to protect against high temperature and high amperage conditions.

⚠ WARNING	
	ELECTRIC SHOCK HAZARD Disconnect power to the unit before servicing. Failure to follow this warning could result in serious injury or death.

BLOWER/FAN MOTOR - TEST

1. Determine that capacitor is serviceable.
2. Disconnect fan motor wires from fan speed switch or system switch.
3. Apply "live" test cord probes on black wire and common terminal of capacitor. Motor should run at high speed.
4. Apply "live" test cord probes on red wire and common terminal of capacitor. Motor should run at low speed.
5. Apply "live" test cord probes on each of the remaining wires from the speed switch or system switch to test intermediate speeds. If the control is in the "MoneySaver" mode and the thermostat calls for cooling, the fan will start - then stop after approximately 2 minutes; then the fan and compressor will start together approximately 2 minutes later.

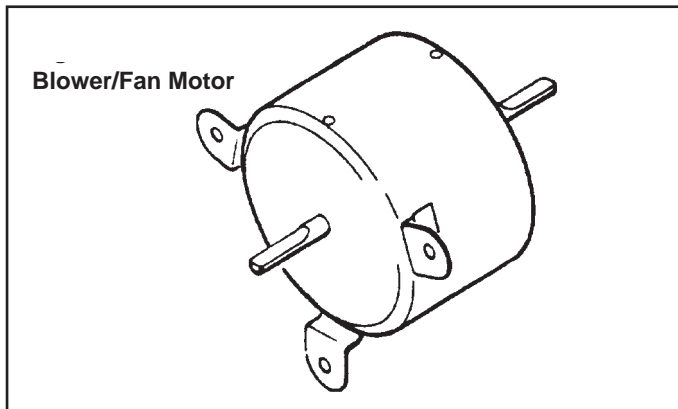

CAPACITORS

⚠ WARNING	
	ELECTRIC SHOCK HAZARD Turn off electric power before servicing. Discharge capacitor with a 20,000 Ohm 2 Watt resistor before handling. Failure to do so may result in personal injury, or death.

Many motor capacitors are internally fused. Shorting the terminals will blow the fuse, ruining the capacitor. A 20,000 ohm 2 watt resistor can be used to discharge capacitors safely. Remove wires from capacitor and place resistor across terminals. When checking a dual capacitor with a capacitor analyzer or ohmmeter, both sides must be tested.

Capacitor Check with Capacitor Analyzer

The capacitor analyzer will show whether the capacitor is "open" or "shorted." It will tell whether the capacitor is within its micro farads rating and it will show whether the capacitor is operating at the proper power-factor percentage. The instrument will automatically discharge the capacitor when the test switch is released.

Capacitor Connections

The starting winding of a motor can be damaged by a shorted and grounded running capacitor. This damage usually can be avoided by proper connection of the running capacitor terminals.

From the supply line on a typical 230 volt circuit, a 115 volt potential exists from the "R" terminal to ground through a possible short in the capacitor. However, from the "S" or start terminal, a much higher potential, possibly as high as 400 volts, exists because of the counter EMF generated in the start winding. Therefore, the possibility of capacitor failure is much greater when the identified terminal is connected to the "S" or start terminal. The identified terminal should always be connected to the supply line, or "R" terminal, never to the "S" terminal.

When connected properly, a shorted or grounded running capacitor will result in a direct short to ground from the "R" terminal and will blow the line fuse. The motor protector will protect the main winding from excessive temperature.

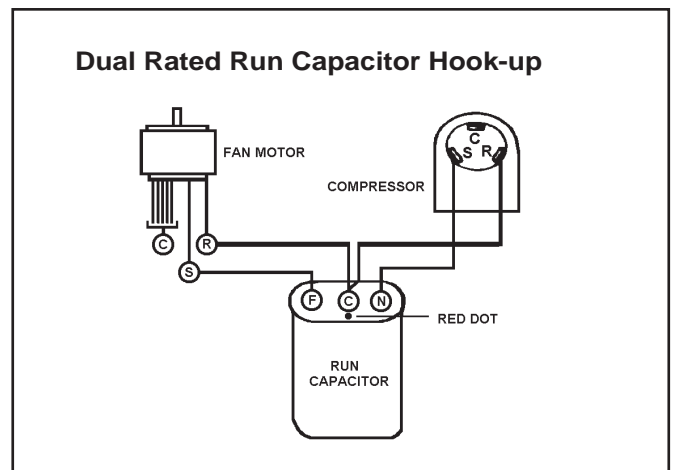

COMPONENTS TESTING (Continued)

HEATING ELEMENT

All electric heat models are equipped with a heating element. The EQ08 has a 1.15 KW element.

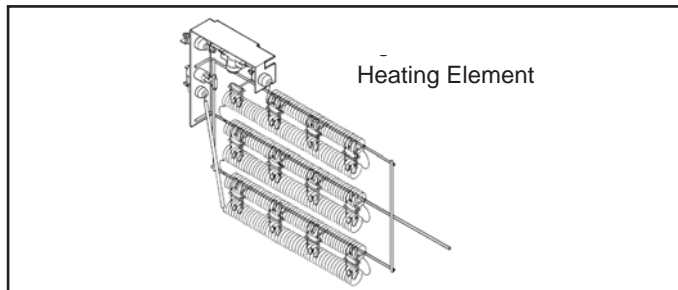

The heating element contains a fuse link and a heater limit switch. The fuse link is in series with the power supply and will open and interrupt the power when the temperature reaches 199°F or a short circuit occurs in the heating element. Once the fuse link separates, a new fuse link must be installed.

NOTE: Always replace with the exact replacement.

The heater element has a high limit control. This control is a bimetal thermostat mounted in the top of the heating element.

Should the fan motor fail or filter become clogged, the high limit control will open and interrupt power to the heater before reaching an unsafe temperature condition.

The control is designed to open at 110°F ±6°F. Test continuity below 110°F.

TESTING THE HEATING ELEMENT

⚠ WARNING	
	ELECTRIC SHOCK HAZARD Disconnect power to the unit before servicing. Failure to follow this warning could result in serious injury or death.

Testing of the elements can be made with an ohmmeter across the terminals after the connecting wires have been removed. A cold resistance reading of approximately 10.11 ohms for the 1.15 KW heater should be registered.

DRAIN PAN VALVE

During the cooling mode of operation, condensate which collects in the drain pan is picked up by the condenser fan blade and sprayed onto the condenser coil. This assists in cooling the refrigerant plus evaporating the water.

During the heating mode of operation, it is necessary that water be removed to prevent it from freezing during cold outside temperatures. This could cause the condenser fan blade to freeze in the accumulated water and prevent it from turning.

To provide a means of draining this water, a bellows type drain valve is installed over a drain opening in the base pan.

This valve is temperature sensitive and will open when the outside temperature reaches 40°F. The valve will close gradually as the temperature rises above 40°F to fully close at 60°F.

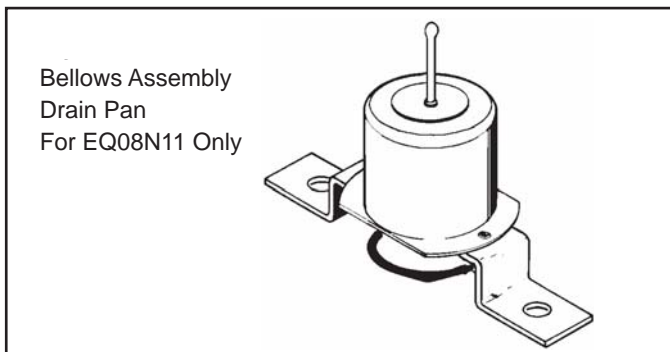

REFRIGERATION SEQUENCE OF OPERATION

A good understanding of the basic operation of the refrigeration system is essential for the service technician. Without this understanding, accurate troubleshooting of refrigeration system problems will be more difficult and time consuming, if not (in some cases) entirely impossible. The refrigeration system uses four basic principles (laws) in its operation they are as follows:

1. "Heat always flows from a warmer body to a cooler body."
2. "Heat must be added to or removed from a substance before a change in state can occur"
3. "Flow is always from a higher pressure area to a lower pressure area."
4. "The temperature at which a liquid or gas changes state is dependent upon the pressure."

The refrigeration cycle begins at the compressor. Starting the compressor creates a low pressure in the suction line which draws refrigerant gas (vapor) into the compressor. The compressor then "compresses" this refrigerant, raising its pressure and its (heat intensity) temperature.

The refrigerant leaves the compressor through the discharge Line as a hot High pressure gas (vapor). The refrigerant enters the condenser coil where it gives up some of its heat. The condenser fan moving air across the coil's finned surface facilitates the transfer of heat from the refrigerant to the relatively cooler outdoor air.

When a sufficient quantity of heat has been removed from the refrigerant gas (vapor), the refrigerant will "condense" (i.e. change to a liquid). Once the refrigerant has been condensed (changed) to a liquid it is cooled even further by the air that continues to flow across the condenser coil.

The RAC design determines at exactly what point (in the condenser) the change of state (i.e. gas to a liquid) takes place. In all cases, however, the refrigerant must be totally condensed (changed) to a Liquid before leaving the condenser coil.

The refrigerant leaves the condenser Coil through the liquid line as a warm high pressure liquid. It next will pass through the refrigerant drier (if so equipped). It is the function of the drier to trap any moisture present in the system, contaminants, and large particulate matter.

The liquid refrigerant next enters the metering device. The metering device is a capillary tube. The purpose of the metering device is to "meter" (i.e. control or measure) the quantity of refrigerant entering the evaporator coil.

In the case of the capillary tube this is accomplished (by design) through size (and length) of device, and the pressure difference present across the device.

Since the evaporator coil is under a lower pressure (due to the suction created by the compressor) than the liquid line, the liquid refrigerant leaves the metering device entering the evaporator coil. As it enters the evaporator coil, the larger area and lower pressure allows the refrigerant to expand and lower its temperature (heat intensity). This expansion is often referred to as "boiling". Since the unit's blower is moving indoor air across the finned surface of the evaporator coil, the expanding refrigerant absorbs some of that heat. This results in a lowering of the indoor air temperature, hence the "cooling" effect.

The expansion and absorbing of heat cause the liquid refrigerant to evaporate (i.e. change to a gas). Once the refrigerant has been evaporated (changed to a gas), it is heated even further by the air that continues to flow across the evaporator coil.

The particular system design determines at exactly what point (in the evaporator) the change of state (i.e. liquid to a gas) takes place. In all cases, however, the refrigerant must be totally evaporated (changed) to a gas before leaving the evaporator coil.

The low pressure (suction) created by the compressor causes the refrigerant to leave the evaporator through the suction line as a cool low pressure vapor. The refrigerant then returns to the compressor, where the cycle is repeated.

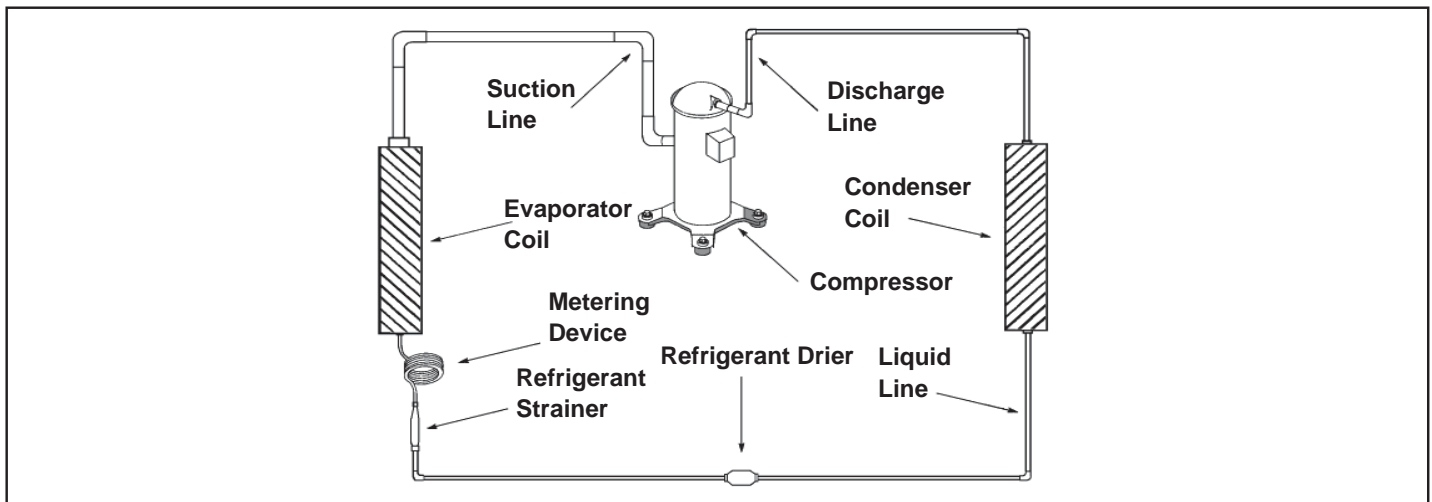

R-410A SEALED SYSTEM REPAIR CONSIDERATIONS

⚠ WARNING	
	<p>Refrigeration system under high pressure</p> <p>Do not puncture, heat, expose to flame or incinerate.</p> <p>Only certified refrigeration technicians should service this equipment.</p> <p>R410A systems operate at higher pressures than R22 equipment. Appropriate safe service and handling practices must be used.</p> <p>Only use gauge sets designed for use with R410A. Do not use standard R22 gauge sets.</p>

The following is a list of important considerations when working with R-410A equipment

- R-410A pressure is approximately 60% higher than R-22 pressure.
- R-410A cylinders must not be allowed to exceed 125 F, they may leak or rupture.
- R-410A must never be pressurized with a mixture of air, it may become flammable.
- Servicing equipment and components must be specifically designed for use with R-410A and dedicated to prevent contamination.
- Manifold sets must be equipped with gauges capable of reading 750 psig (high side) and 200 psig (low side), with a 500-psig low-side retard.
- Gauge hoses must have a minimum 750-psig service pressure rating
- Recovery cylinders must have a minimum service pressure rating of 400 psig, (DOT 4BA400 and DOT BW400 approved cylinders).
- POE (Polyol-Ester) lubricants must be used with R-410A equipment.
- To prevent moisture absorption and lubricant contamination, do not leave the refrigeration system open to the atmosphere longer than 1 hour.
- Weigh-in the refrigerant charge into the high side of the system.
- Introduce liquid refrigerant charge into the high side of the system.
- For low side pressure charging of R-410A, use a charging adaptor.
- Use Friedrich approved R-410A filter dryers only.

R-410A SEALED REFRIGERATION SYSTEM REPAIRS

IMPORTANT

SEALED SYSTEM REPAIRS TO COOL-ONLY MODELS REQUIRE THE INSTALLATION OF A LIQUID LINE DRIER.

EQUIPMENT REQUIRED:

1. Voltmeter
2. Ammeter
3. Ohmmeter
4. E.P.A. Approved Refrigerant Recovery System
5. Vacuum Pump (capable of 200 microns or less vacuum.)
6. Acetylene Welder
7. Electronic Halogen Leak Detector capable of detecting HFC (Hydrofluorocarbon) refrigerants.
8. Accurate refrigerant charge measuring device such as:
 - a. Balance Scales - 1/2 oz. accuracy
 - b. Charging Board - 1/2 oz. accuracy
9. High Pressure Gauge - (0 to 750 lbs.)
10. Low Pressure Gauge - (-30 to 200 lbs.)
11. Vacuum Gauge - (0 - 1000 microns)
12. Facilities for flowing nitrogen through refrigeration tubing during all brazing processes.

EQUIPMENT MUST BE CAPABLE OF:

1. Recovering refrigerant to EPA required levels.
2. Evacuation from both the high side and low side of the system simultaneously.
3. Introducing refrigerant charge into high side of the system.
4. Accurately weighing the refrigerant charge introduced into the system.

WARNING



RISK OF ELECTRIC SHOCK

Unplug and/or disconnect all electrical power to the unit before performing inspections, maintenances or service.

Failure to do so could result in electric shock, serious injury or death.

WARNING



HIGH PRESSURE HAZARD

Sealed Refrigeration System contains refrigerant and oil under high pressure.

Proper safety procedures must be followed, and proper protective clothing must be worn when working with refrigerants.

Failure to follow these procedures could result in serious injury or death.

Proper refrigerant charge is essential to proper unit operation. Operating a unit with an improper refrigerant charge will result in reduced performance (capacity) and/or efficiency. Accordingly, the use of proper charging methods during servicing will insure that the unit is functioning as designed and that its compressor will not be damaged.

Too much refrigerant (overcharge) in the system is just as bad (if not worse) than not enough refrigerant (undercharge). They both can be the source of certain compressor failures if they remain uncorrected for any period of time. Quite often, other problems (such as low air flow across evaporator, etc.) are misdiagnosed as refrigerant charge problems. The refrigerant circuit diagnosis chart will assist you in properly diagnosing these systems.

An overcharged unit will at times return liquid refrigerant (slugging) back to the suction side of the compressor eventually causing a mechanical failure within the compressor. This mechanical failure can manifest itself as valve failure, bearing failure, and/or other mechanical failure. The specific type of failure will be influenced by the amount of liquid being returned, and the length of time the slugging continues.

Not enough refrigerant (undercharge) on the other hand, will cause the temperature of the suction gas to increase to the point where it does not provide sufficient cooling for the compressor motor. When this occurs, the motor winding temperature will increase causing the motor to overheat and possibly cycle open the compressor overload protector. Continued overheating of the motor windings and/or cycling of the overload will eventually lead to compressor motor or overload failure.

Refrigerant Charging

NOTE: Because the Kuhl Q system is a sealed system, service process tubes will have to be installed. First install a line tap and remove refrigerant from system. Make necessary sealed system repairs and vacuum system. Crimp process tube line and solder end shut. Do not leave a service valve in the sealed system.

REFRIGERATION SEQUENCE OF OPERATION

A good understanding of the basic operation of the refrigeration system is essential for the service technician. Without this understanding, accurate troubleshooting of refrigeration system problems will be more difficult and time consuming, if not (in some cases) entirely impossible. The refrigeration system uses four basic principles (laws) in its operation they are as follows:

1. "Heat always flows from a warmer body to a cooler body."
2. "Heat must be added to or removed from a substance before a change in state can occur"
3. "Flow is always from a higher pressure area to a lower pressure area."
4. "The temperature at which a liquid or gas changes state is dependent upon the pressure."

The refrigeration cycle begins at the compressor. Starting the compressor creates a low pressure in the suction line which draws refrigerant gas (vapor) into the compressor. The compressor then "compresses" this refrigerant, raising its pressure and its (heat intensity) temperature.

The refrigerant leaves the compressor through the discharge Line as a hot High pressure gas (vapor). The refrigerant enters the condenser coil where it gives up some of its heat. The condenser fan moving air across the coil's finned surface facilitates the transfer of heat from the refrigerant to the relatively cooler outdoor air.

When a sufficient quantity of heat has been removed from the refrigerant gas (vapor), the refrigerant will "condense" (i.e. change to a liquid). Once the refrigerant has been condensed (changed) to a liquid it is cooled even further by the air that continues to flow across the condenser coil.

The RAC design determines at exactly what point (in the condenser) the change of state (i.e. gas to a liquid) takes place. In all cases, however, the refrigerant must be totally condensed (changed) to a Liquid before leaving the condenser coil.

The refrigerant leaves the condenser Coil through the liquid line as a warm high pressure liquid. It next will pass through the refrigerant drier (if so equipped). It is the function of the drier to trap any moisture present in the system, contaminants, and large particulate matter.

The liquid refrigerant next enters the metering device. The metering device is a capillary tube. The purpose of the metering device is to "meter" (i.e. control or measure) the quantity of refrigerant entering the evaporator coil.

In the case of the capillary tube this is accomplished (by design) through size (and length) of device, and the pressure difference present across the device.

Since the evaporator coil is under a lower pressure (due to the suction created by the compressor) than the liquid line, the liquid refrigerant leaves the metering device entering the evaporator coil. As it enters the evaporator coil, the larger area and lower pressure allows the refrigerant to expand and lower its temperature (heat intensity). This expansion is often referred to as "boiling". Since the unit's blower is moving indoor air across the finned surface of the evaporator coil, the expanding refrigerant absorbs some of that heat. This results in a lowering of the indoor air temperature, hence the "cooling" effect.

The expansion and absorbing of heat cause the liquid refrigerant to evaporate (i.e. change to a gas). Once the refrigerant has been evaporated (changed to a gas), it is heated even further by the air that continues to flow across the evaporator coil.

The particular system design determines at exactly what point (in the evaporator) the change of state (i.e. liquid to a gas) takes place. In all cases, however, the refrigerant must be totally evaporated (changed) to a gas before leaving the evaporator coil.

The low pressure (suction) created by the compressor causes the refrigerant to leave the evaporator through the suction line as a cool low pressure vapor. The refrigerant then returns to the compressor, where the cycle is repeated.

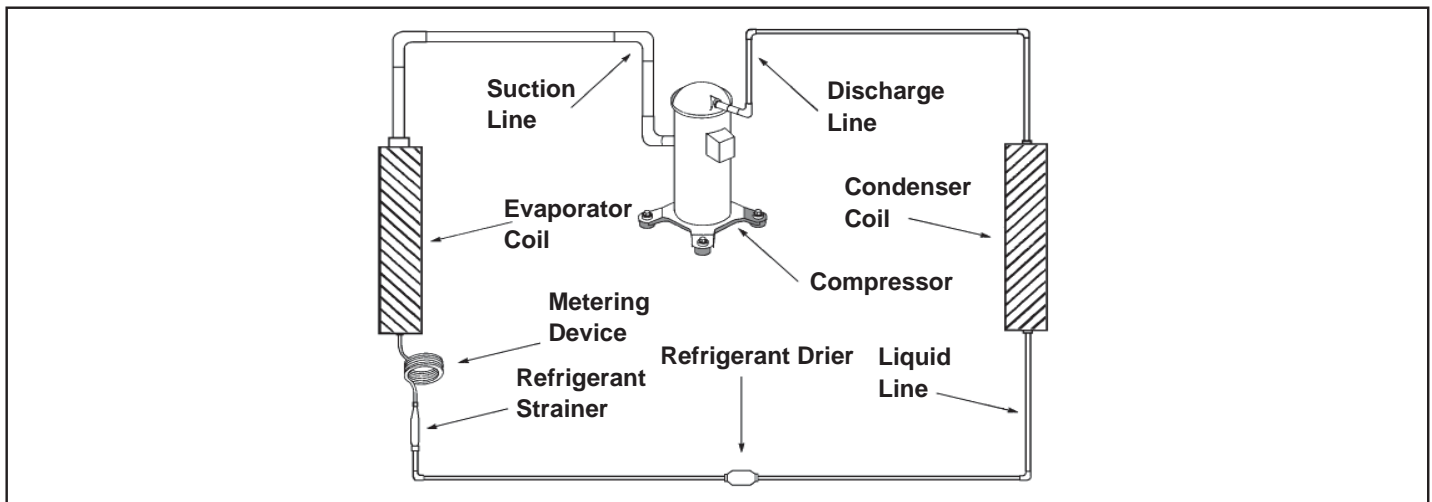

R-410A SEALED REFRIGERATION SYSTEM REPAIRS

IMPORTANT

SEALED SYSTEM REPAIRS TO COOL-ONLY MODELS REQUIRE THE INSTALLATION OF A LIQUID LINE DRIER.

EQUIPMENT REQUIRED:

1. Voltmeter
2. Ammeter
3. Ohmmeter
4. E.P.A. Approved Refrigerant Recovery System
5. Vacuum Pump (capable of 200 microns or less vacuum.)
6. Acetylene Welder
7. Electronic Halogen Leak Detector capable of detecting HFC (Hydrofluorocarbon) refrigerants.
8. Accurate refrigerant charge measuring device such as:
 - a. Balance Scales - 1/2 oz. accuracy
 - b. Charging Board - 1/2 oz. accuracy
9. High Pressure Gauge - (0 to 750 lbs.)
10. Low Pressure Gauge - (-30 to 200 lbs.)
11. Vacuum Gauge - (0 - 1000 microns)
12. Facilities for flowing nitrogen through refrigeration tubing during all brazing processes.

EQUIPMENT MUST BE CAPABLE OF:

1. Recovering refrigerant to EPA required levels.
2. Evacuation from both the high side and low side of the system simultaneously.
3. Introducing refrigerant charge into high side of the system.
4. Accurately weighing the refrigerant charge introduced into the system.

WARNING



RISK OF ELECTRIC SHOCK

Unplug and/or disconnect all electrical power to the unit before performing inspections, maintenances or service.

Failure to do so could result in electric shock, serious injury or death.

WARNING



HIGH PRESSURE HAZARD

Sealed Refrigeration System contains refrigerant and oil under high pressure.

Proper safety procedures must be followed, and proper protective clothing must be worn when working with refrigerants.

Failure to follow these procedures could result in serious injury or death.

Proper refrigerant charge is essential to proper unit operation. Operating a unit with an improper refrigerant charge will result in reduced performance (capacity) and/or efficiency. Accordingly, the use of proper charging methods during servicing will insure that the unit is functioning as designed and that its compressor will not be damaged.

Too much refrigerant (overcharge) in the system is just as bad (if not worse) than not enough refrigerant (undercharge). They both can be the source of certain compressor failures if they remain uncorrected for any period of time. Quite often, other problems (such as low air flow across evaporator, etc.) are misdiagnosed as refrigerant charge problems. The refrigerant circuit diagnosis chart will assist you in properly diagnosing these systems.

An overcharged unit will at times return liquid refrigerant (slugging) back to the suction side of the compressor eventually causing a mechanical failure within the compressor. This mechanical failure can manifest itself as valve failure, bearing failure, and/or other mechanical failure. The specific type of failure will be influenced by the amount of liquid being returned, and the length of time the slugging continues.

Not enough refrigerant (undercharge) on the other hand, will cause the temperature of the suction gas to increase to the point where it does not provide sufficient cooling for the compressor motor. When this occurs, the motor winding temperature will increase causing the motor to overheat and possibly cycle open the compressor overload protector. Continued overheating of the motor windings and/or cycling of the overload will eventually lead to compressor motor or overload failure.

Refrigerant Charging

NOTE: Because the KuhlQ system is a sealed system, service process tubes will have to be installed. First install a line tap and remove refrigerant from system. Make necessary sealed system repairs and vacuum system. Crimp process tube line and solder end shut. Do not leave a service valve in the sealed system.

Method Of Charging / Repairs

The acceptable method for charging the RAC system is the Weighed in Charge Method. The weighed in charge method is applicable to all units. It is the preferred method to use, as it is the most accurate.

The weighed in method should always be used whenever a charge is removed from a unit such as for a leak repair, compressor replacement, or when there is no refrigerant charge left in the unit. To charge by this method, requires the following steps:

1. Install a piercing valve to remove refrigerant from the sealed system. (Piercing valve must be removed from the system before recharging.)
2. Recover Refrigerant in accordance with EPA regulations.

⚠ WARNING	
	BURN HAZARD Proper safety procedures must be followed, and proper protective clothing must be worn when working with a torch. Failure to follow these procedures could result in moderate or serious injury.

3. Install a process tube to sealed system.

⚠ CAUTION	
	FREEZE HAZARD Proper safety procedures must be followed, and proper protective clothing must be worn when working with liquid refrigerant. Failure to follow these procedures could result in minor to moderate injury.

4. Make necessary repairs to system.
5. Evacuate system to 200 microns or less.
6. Weigh in refrigerant with the property quantity of R410-A refrigerant.
7. Start unit, and verify performance.

⚠ WARNING	
	BURN HAZARD Proper safety procedures must be followed, and proper protective clothing must be worn when working with a torch. Failure to follow these procedures could result in moderate or serious injury.

8. Crimp the process tube and solder the end shut.

⚠ WARNING



ELECTRIC SHOCK HAZARD

Turn off electric power before service or installation.

Extreme care must be used, if it becomes necessary to work on equipment with power applied.

Failure to do so could result in serious injury or death.

⚠ WARNING



HIGH PRESSURE HAZARD

Sealed Refrigeration System contains refrigerant and oil under high pressure.

Proper safety procedures must be followed, and proper protective clothing must be worn when working with refrigerants.

Failure to follow these procedures could result in serious injury or death.

Undercharged Refrigerant Systems

An undercharged system will result in poor performance (low pressures, etc.) in both the heating and cooling cycle.

Whenever you service a unit with an undercharge of refrigerant, always suspect a leak. The leak must be repaired before charging the unit.

To check for an undercharged system, turn the unit on, allow the compressor to run long enough to establish working pressures in the system (15 to 20 minutes).

During the cooling cycle you can listen carefully at the exit of the metering device into the evaporator; an intermittent hissing and gurgling sound indicates a low refrigerant charge. Intermittent frosting and thawing of the evaporator is another indication of a low charge, however, frosting and thawing can also be caused by insufficient air over the evaporator.

Checks for an undercharged system can be made at the compressor. If the compressor seems quieter than normal, it is an indication of a low refrigerant charge.

A check of the amperage drawn by the compressor motor should show a lower reading. (Check the Unit Specification.) After the unit has run 10 to 15 minutes, check the gauge pressures. Gauges connected to system with an undercharge will have low head pressures and substantially low suction pressures.

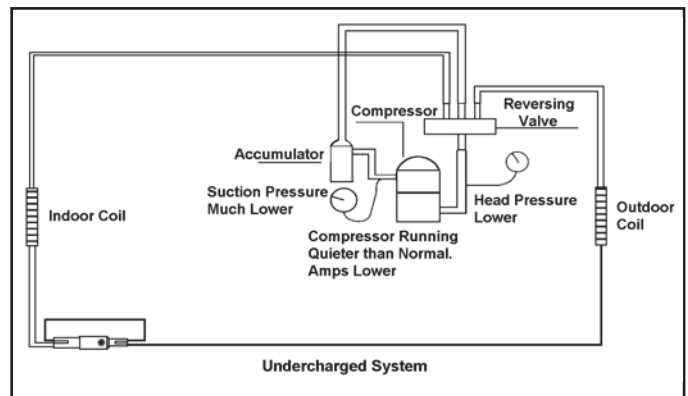

Overcharged Refrigerant Systems

Compressor amps will be near normal or higher. Noncondensables can also cause these symptoms. To confirm, remove some of the charge, if conditions improve, system may be overcharged. If conditions don't improve, Noncondensables are indicated.

Whenever an overcharged system is indicated, always make sure that the problem is not caused by air flow problems. Improper air flow over the evaporator coil may indicate some of the same symptoms as an over charged system.

An overcharge can cause the compressor to fail, since it would be "slugged" with liquid refrigerant.

The charge for any system is critical. When the compressor is noisy, suspect an overcharge, when you are sure that the air quantity over the evaporator coil is correct. Icing

of the evaporator will not be encountered because the refrigerant will boil later if at all. Gauges connected to system will usually have higher head pressure (depending upon amount of over charge). Suction pressure should be slightly higher.

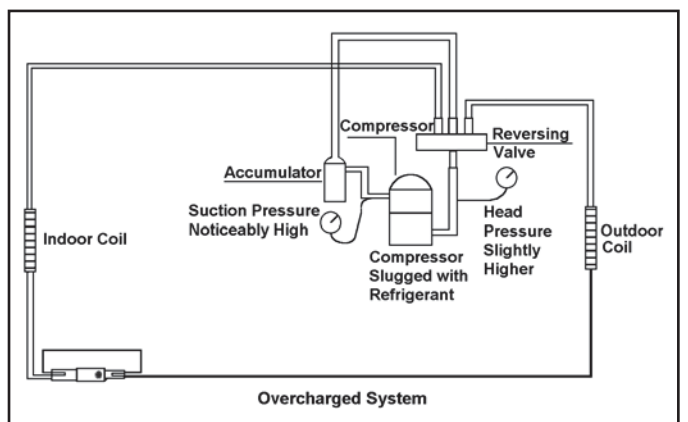

Restricted Refrigerant System

Troubleshooting a restricted refrigerant system can be difficult. The following procedures are the more common problems and solutions to these problems. There are two types of refrigerant restrictions: Partial restrictions and complete restrictions.

A partial restriction allows some of the refrigerant to circulate through the system.

With a complete restriction there is no circulation of refrigerant in the system.

Restricted refrigerant systems display the same symptoms as a "low-charge condition."

When the unit is shut off, the gauges may equalize very slowly.

Gauges connected to a completely restricted system will run in a deep vacuum. When the unit is shut off, the gauges will not equalize at all.

A quick check for either condition begins at the evaporator. With a partial restriction, there may be gurgling sounds

at the metering device entrance to the evaporator. The evaporator in a partial restriction could be partially frosted or have an ice ball close to the entrance of the metering device. Frost may continue on the suction line back to the compressor.

Often a partial restriction of any type can be found by feel, as there is a temperature difference from one side of the restriction to the other.

With a complete restriction, there will be no sound at the metering device entrance. An amperage check of the compressor with a partial restriction may show normal current when compared to the unit specification. With a complete restriction the current drawn may be considerably less than normal, as the compressor is running in a deep vacuum (no load.) Much of the area of the condenser will be relatively cool since most or all of the liquid refrigerant will be stored there.

The following conditions are based primarily on a system in the cooling mode.

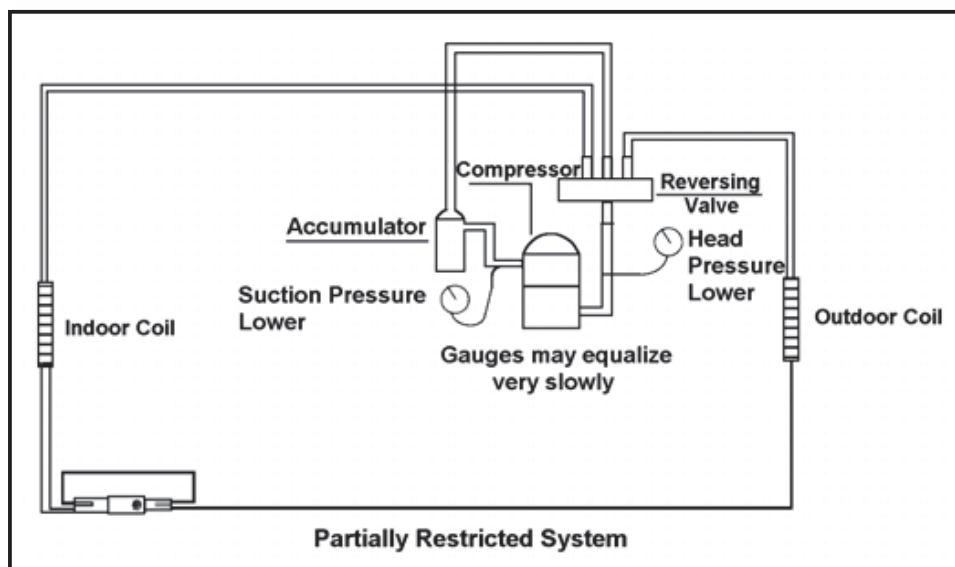
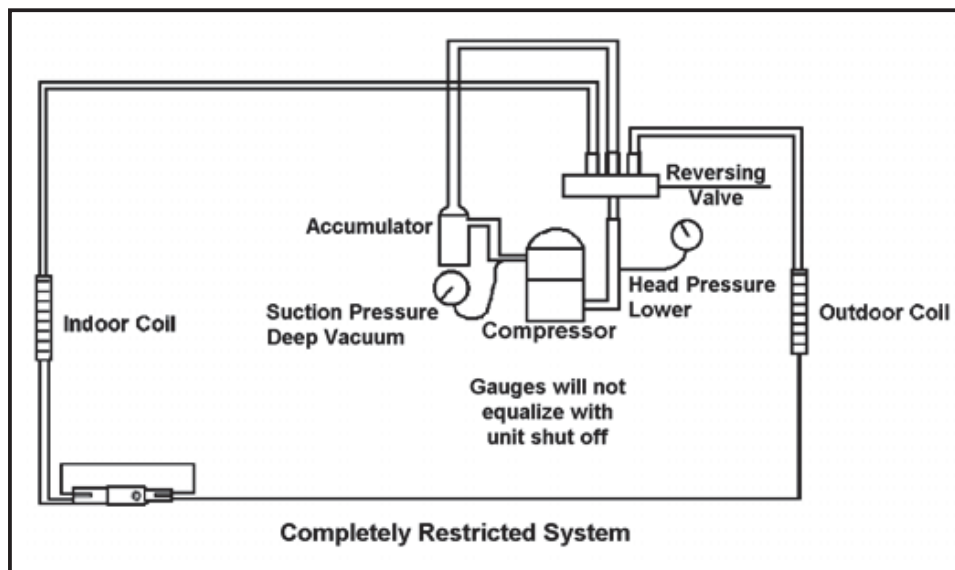

COMPRESSOR CHECKS

WARNING



ELECTRIC SHOCK HAZARD

Turn off electric power before service or installation. Extreme care must be used, if it becomes necessary to work on equipment with power applied.

Failure to do so could result in serious injury or death.

Locked Rotor Voltage (L.R.V.) Test

Locked rotor voltage (L.R.V.) is the actual voltage available at the compressor under a stalled condition.

Single Phase Connections

Disconnect power from unit. Using a voltmeter, attach one lead of the meter to the run "R" terminal on the compressor and the other lead to the common "C" terminal of the compressor. Restore power to unit.

Determine L.R.V.

Start the compressor with the volt meter attached; then stop the unit. Attempt to restart the compressor within a couple of seconds and immediately read the voltage on the meter. The compressor under these conditions will not start and will usually kick out on overload within a few seconds since the pressures in the system will not have had time to equalize. Voltage should be at or above minimum voltage of 197 VAC, as specified on the rating plate. If less than minimum, check for cause of inadequate power supply; i.e., incorrect wire size, loose electrical connections, etc.

Amperage (L.R.A.) Test

The running amperage of the compressor is the most important of these readings. A running amperage higher than that indicated in the performance data indicates that a problem exists mechanically or electrically.

Single Phase Running and L.R.A. Test

NOTE: Consult the specification and performance section for running amperage. The L.R.A. can also be found on the rating plate.

Select the proper amperage scale and clamp the meter probe around the wire to the "C" terminal of the compressor. Turn on the unit and read the running amperage on the meter. If the compressor does not start, the reading will indicate the locked rotor amperage (L.R.A.).

External Overload

The compressor is equipped with an external overload which senses both motor amperage and winding temperature. High motor temperature or amperage heats the overload causing it to open, breaking the common circuit within the compressor.

Heat generated within the compressor shell, usually due to recycling of the motor, is slow to dissipate. It may take anywhere from a few minutes to several hours for the overload to reset.

Checking the External Overload

WARNING



ELECTRIC SHOCK HAZARD

Turn off electric power before service or installation. Extreme care must be used, if it becomes necessary to work on equipment with power applied.

Failure to do so could result in serious injury or death.

WARNING



BURN HAZARD

Certain unit components operate at temperatures hot enough to cause burns.

Proper safety procedures must be followed, and proper protective clothing must be worn.

Failure to follow this warning could result in moderate to serious injury.

With power off, remove the leads from compressor terminals. If the compressor is hot, allow the overload to cool before starting check. Using an ohmmeter, test continuity across the terminals of the external overload. If you do not have continuity; this indicates that the overload is open and must be replaced.

Single Phase Resistance Test

Remove the leads from the compressor terminals and set the ohmmeter on the lowest scale (R x 1).

Touch the leads of the ohmmeter from terminals common to start ("C" to "S"). Next, touch the leads of the ohmmeter from terminals common to run ("C" to "R").

Add values "C" to "S" and "C" to "R" together and check resistance from start to run terminals ("S" to "R"). Resistance "S" to "R" should equal the total of "C" to "S" and "C" to "R."

In a single phase PSC compressor motor, the highest value will be from the start to the run connections ("S" to "R"). The next highest resistance is from the start to the common connections ("S" to "C"). The lowest resistance is from the run to common. ("C" to "R") Before replacing a compressor, check to be sure it is defective.

GROUND TEST

Use an ohmmeter set on its highest scale. Touch one lead to the compressor body (clean point of contact as a good connection is a must) and the other probe in turn to each compressor terminal. If a reading is obtained the compressor is grounded and must be replaced.

Check the complete electrical system to the compressor and compressor internal electrical system, check to be certain that compressor is not out on internal overload.

Complete evaluation of the system must be made whenever you suspect the compressor is defective. If the compressor has been operating for sometime, a careful examination must be made to determine why the compressor failed.

Many compressor failures are caused by the following conditions:

1. Improper air flow over the evaporator.
2. Overcharged refrigerant system causing liquid to be returned to the compressor.
3. Restricted refrigerant system.
4. Lack of lubrication.
5. Liquid refrigerant returning to compressor causing oil to be washed out of bearings.
6. Noncondensables such as air and moisture in the system. Moisture is extremely destructive to a refrigerant system.
7. Defective capacitors.

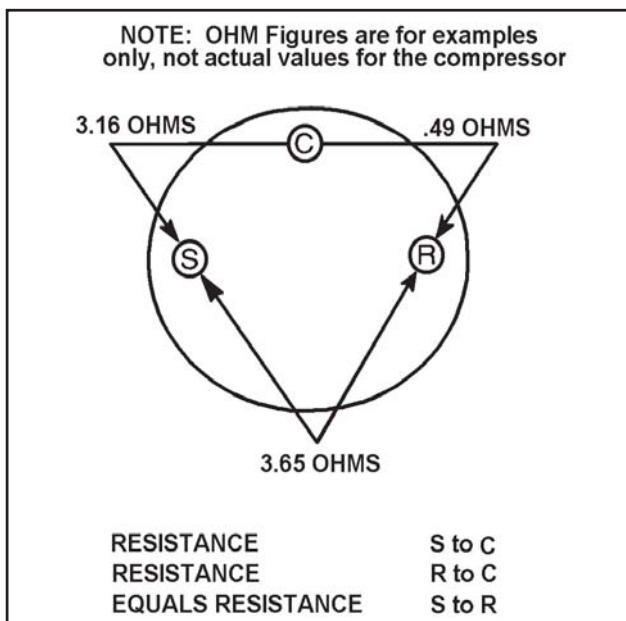

COMPRESSOR REPLACEMENT

Recommended procedure for compressor replacement

⚠ WARNING	
	<p>RISK OF ELECTRIC SHOCK</p> <p>Unplug and/or disconnect all electrical power to the unit before performing inspections, maintenances or service.</p> <p>Failure to do so could result in electric shock, serious injury or death.</p>

1. Be certain to perform all necessary electrical and refrigeration tests to be sure the compressor is actually defective before replacing.

⚠ WARNING	
	<p>HIGH PRESSURE HAZARD</p> <p>Sealed Refrigeration System contains refrigerant and oil under high pressure.</p> <p>Proper safety procedures must be followed, and proper protective clothing must be worn when working with refrigerants.</p> <p>Failure to follow these procedures could result in serious injury or death.</p>

2. Recover all refrigerant from the system through the process tubes. **PROPER HANDLING OF RECOVERED REFRIGERANT ACCORDING TO EPA REGULATIONS IS REQUIRED.** Do not use gauge manifold for this purpose if there has been a burnout. You will contaminate your manifold and hoses. Use a Schrader valve adapter and copper tubing for burnout failures.

⚠ WARNING	
	<p>HIGH TEMPERATURES</p> <p>Extreme care, proper judgment and all safety procedures must be followed when testing, troubleshooting, handling or working around unit while in operation with high temperature components. Wear protective safety aids such as: gloves, clothing etc.</p> <p>Failure to do so could result in serious burn injury.</p>

NOTICE	
FIRE HAZARD	
<p>The use of a torch requires extreme care and proper judgment. Follow all safety recommended precautions and protect surrounding areas with fire proof materials. Have a fire extinguisher readily available. Failure to follow this notice could result in moderate to serious property damage.</p>	

3. After all refrigerant has been recovered, disconnect suction and discharge lines from the compressor and remove compressor. Be certain to have both suction and discharge process tubes open to atmosphere.
4. Carefully pour a small amount of oil from the suction stub of the defective compressor into a clean container.
5. Using an acid test kit (one shot or conventional kit), test the oil for acid content according to the instructions with the kit.
6. If any evidence of a burnout is found, no matter how slight, the system will need to be cleaned up following proper procedures.
7. Install the replacement compressor.

⚠ WARNING	
	<p>EXPLOSION HAZARD</p> <p>The use of nitrogen requires a pressure regulator. Follow all safety procedures and wear protective safety clothing etc.</p> <p>Failure to follow proper safety procedures result in serious injury or death.</p>

8. Pressurize with a combination of R410-A and nitrogen and leak test all connections with an electronic or Halide leak detector. Recover refrigerant and repair any leaks found.

Repeat Step 8 to insure no more leaks are present.

9. Evacuate the system with a good vacuum pump capable of a final vacuum of 200 microns or less. The system should be evacuated through both liquid line and suction line gauge ports. While the unit is being evacuated, seal all openings on the defective compressor. Compressor manufacturers will void warranties on units received not properly sealed. Do not distort the manufacturers tube connections.

⚠ CAUTION	
	<p>FREEZE HAZARD</p> <p>Proper safety procedures must be followed, and proper protective clothing must be worn when working with liquid refrigerant.</p> <p>Failure to follow these procedures could result in minor to moderate injury.</p>

10. Recharge the system with the correct amount of refrigerant. The proper refrigerant charge will be found on the unit rating plate. The use of an accurate measuring device, such as a charging cylinder, electronic scales or similar device is necessary.

SPECIAL PROCEDURE IN THE CASE OF MOTOR COMPRESSOR BURNOUT

⚠ WARNING	
	<p>ELECTRIC SHOCK HAZARD Turn off electric power before service or installation.</p> <p>Failure to do so may result in personal injury, or death.</p>

⚠ WARNING	
	<p>HIGH PRESSURE HAZARD Sealed Refrigeration System contains refrigerant and oil under high pressure.</p> <p>Proper safety procedures must be followed, and proper protective clothing must be worn when working with refrigerants.</p> <p>Failure to follow these procedures could result in serious injury or death.</p>

⚠ WARNING	
	<p>EXPLOSION HAZARD The use of nitrogen requires a pressure regulator. Follow all safety procedures and wear protective safety clothing etc.</p> <p>Failure to follow proper safety procedures result in serious injury or death.</p>

1. Recover all refrigerant and oil from the system.
2. Remove compressor, capillary tube and filter drier from the system.
3. Flush evaporator condenser and all connecting tubing with dry nitrogen or equivalent. Use approved flushing agent to remove all contamination from system. Inspect suction and discharge line for carbon deposits. Remove and clean if necessary. Ensure all acid is neutralized.
4. Reassemble the system, including new drier strainer and capillary tube.
5. Proceed with step 8-10 on previous page.

ROTARY COMPRESSOR SPECIAL TROUBLESHOOTING AND SERVICE

Basically, troubleshooting and servicing rotary compressors is the same as on the reciprocating compressor with only one main exception:

NEVER, under any circumstances, liquid charge a rotary compressor through the **LOW** side. Doing so would cause permanent damage to the new compressor.

Available Accessories

Carbon Filter Kits

Each kit contains three (3) filters.

KWCFQ - Carbon filter kit for "Q" chassis models.

Window Installation Kits

(Standard in Kühl Models without Heat)

KWIKQ

FriedrichLink™ Adapter Accessory:

KWIFI - FriedrichLink™ Adapter Accessory for wireless control and additional programming options

Decorative Color Front Panel Kits:

KWBGQA - Q Model Decorative Front Cover in Classic Beige

KWBLQA - Q Model Decorative Front Cover in Black Onyx

KWBLUQA - Q Model Decorative Front Cover in Cobalt Blue

KWPNQA - Q Model Decorative Front Cover in Pink Diamond

KWREDQA - Q Model Decorative Front Cover in Deep Red

KWWHTQA - Q Model Decorative Front Cover in Designer White

See www.friedrich.com for additional accessories for your unit.

Standard Filter Cleaning / Installation Instructions

STEP 1. Swing the door open and remove the filter by grasping the filter grip and pushing the filter holder upward and outward.

STEP 2. Clean the front frame by washing the dirt from the filter. Use a mild soap solution if necessary. Allow filter to dry.

STEP 3. Install the filter back into the unit. Follow the Instructions on the inside of the front door.

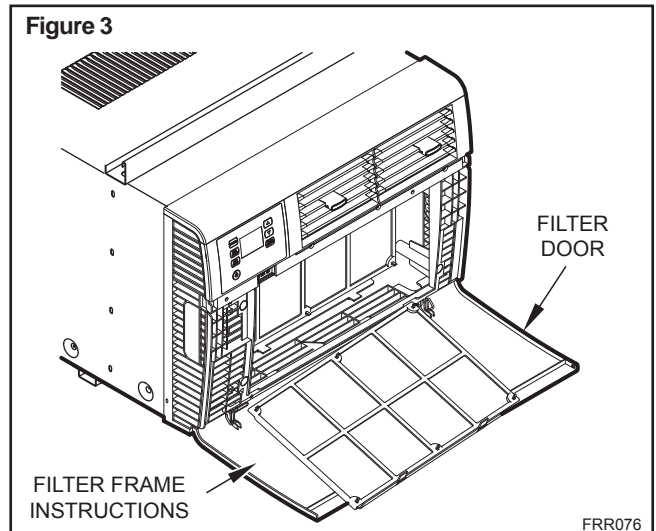
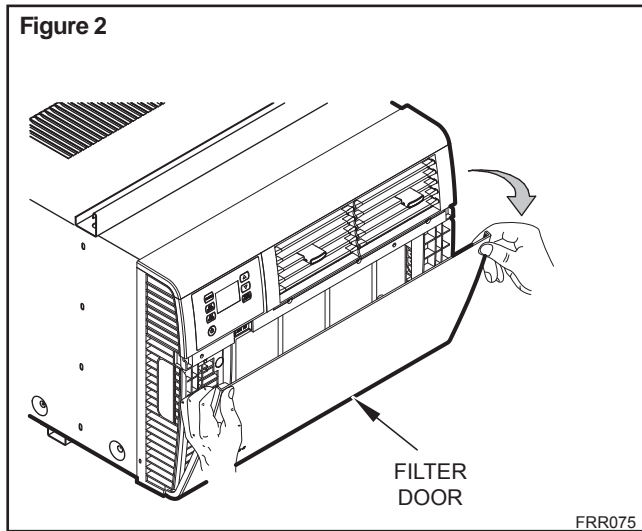

How to Remove the Front Cover

Unplug unit.

STEP 1. Open the Decorative Front Cover, and remove the 4 screws. Save to reinstall later.

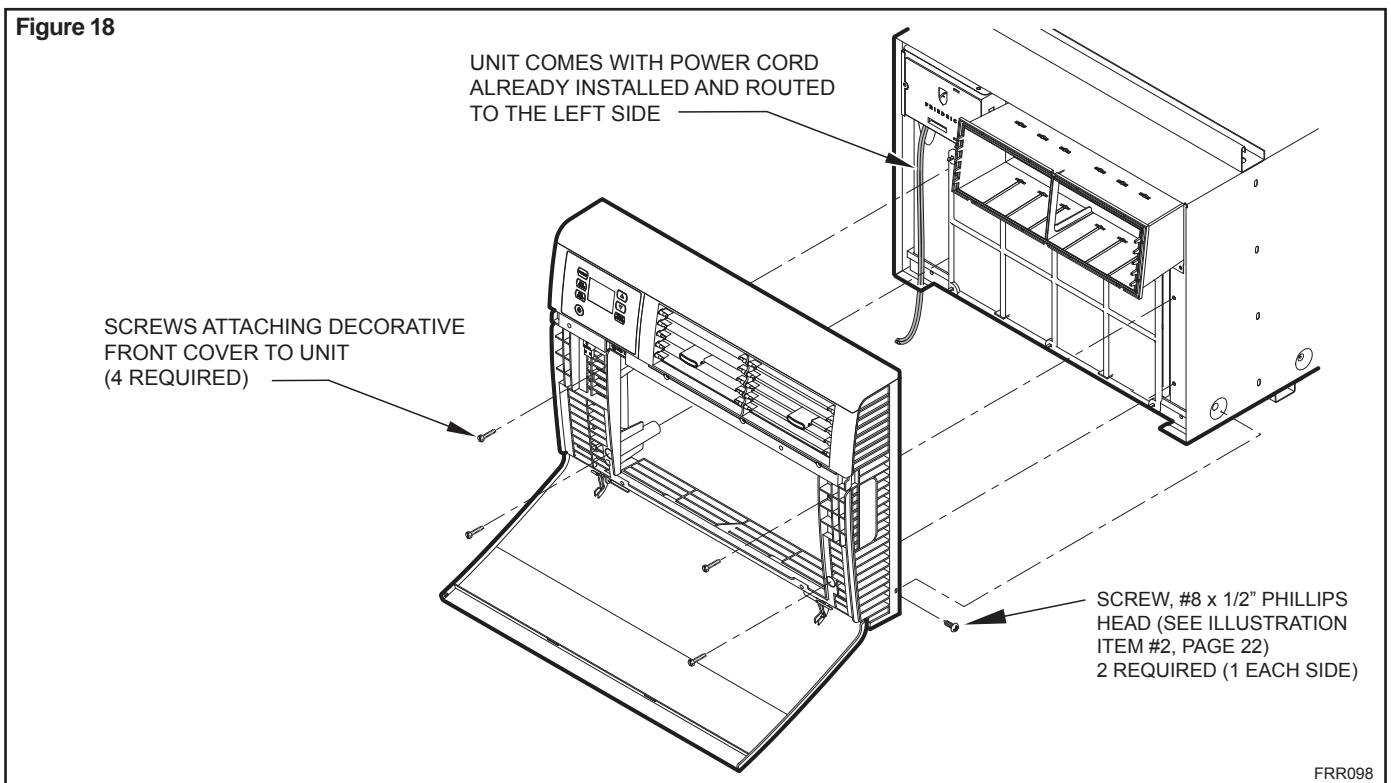

ROUTINE MAINTENANCE

WARNING



ELECTRIC SHOCK HAZARD

Turn off electric power before inspections, maintenances, or service.

Extreme care must be used, if it becomes necessary to work on equipment with power applied.

Failure to do so could result in serious injury or death.

WARNING



EXCESSIVE WEIGHT HAZARD

Use two people to lift or carry the unit, and wear proper protective clothing.

Failure to do so may result in personal injury.

WARNING



CUT/SEVER HAZARD

Be careful with the sharp edges and corners. Wear protective clothing and gloves, etc.

Failure to do so could result in serious injury.

NOTICE

Units are to be inspected and serviced by qualified service personnel only. Use proper protection on surrounding property. Failure to follow this notice could result in moderate or serious property damage.

NOTICE

Do not use a caustic coil cleaning agent on coils or base pan. Use a biodegradable cleaning agent and degreaser, to prevent damage to the coil and/or base pan.

To Remove, Wash and Replace Filter

Lower front panel (See Figure 2). Use handle on filter to flex filter up and out of retainer. Remove filter from unit (See Figure 3). Clean filter monthly or more frequently if needed. Clean the filters with a mild detergent in warm water and allow to dry thoroughly before reinstalling. Refer to accessories section for filter options.

DECORATIVE FRONT COVER

The decorative front and discharge air grille may be cleaned with a mild soap or detergent. Do NOT use solvents or hydrocarbon based cleaners such as acetone, naphtha, gasoline, benzene, etc., to clean the decorative front or air discharge grilles

Use a damp (not wet) cloth when cleaning the control area to prevent water from entering unit, and possibly damaging the electronic control.

COILS AND BASE PAN

The indoor coil (evaporator coil), the outdoor coil (condenser coil) and base pan should be inspected periodically (yearly or bi-yearly) and cleaned of all debris (lint, dirt, leaves, paper, etc.). Clean the coils and base pan with a soft brush and compressed air or vacuum. If using a pressure washer, be careful not to bend the aluminium fin pack. Use a sweeping up and down motion in the direction of the vertical aluminum fin pack when pressure cleaning coils. Cover all electrical components to protect them from water or spray. Allow the unit to dry thoroughly before reinstalling it in the sleeve.

BLOWER WHEEL / HOUSING / CONDENSER FAN / SHROUD

Inspect the indoor blower and its housing, evaporator blade, condenser fan blade and condenser shroud periodically (yearly or bi-yearly) and clean of all debris (lint, dirt, mold, fungus, etc.). Clean the blower housing area and blower wheel with an antibacterial / antifungal cleaner. Use a biodegradable cleaning agent and degreaser on condenser fan and condenser shroud. Use warm or cold water when rinsing these items. Allow all items to dry thoroughly before reinstalling them.

ELECTRONIC / ELECTRICAL / MECHANICAL

Periodically (at least yearly or bi-yearly): inspect all control components: electronic, electrical and mechanical, as well as the power supply. Use proper conditioning or refrigeration thermometer to check testing instruments (voltmeter, ohmmeter, ammeter, wattmeter, etc.) to perform electrical tests. Use an air room, outdoor and coil operating temperatures. Use an electronic tester to measure wet bulb temperatures indoors and outdoors.

ROUTINE MAINTENANCE (Continued)

NOTICE

Do not drill holes in the bottom of the drain pan or the underside of the unit. Not following this notice could result in damage to the unit or condensate water leaking inappropriately which could cause water damage to surrounding property.

SLEEVE / DRAIN

Inspect the sleeve and drain system periodically (at least yearly or bi-yearly) and clean of all obstructions and debris. Clean both areas with an antibacterial and antifungal cleaner. Rinse both items thoroughly with water and ensure that the drain outlets are operating correctly. Check the sealant around the sleeve and reseal areas as needed.

CLEARANCES

Inspect the surrounding area (inside and outside) to ensure that the unit's clearances have not been compromised or altered.

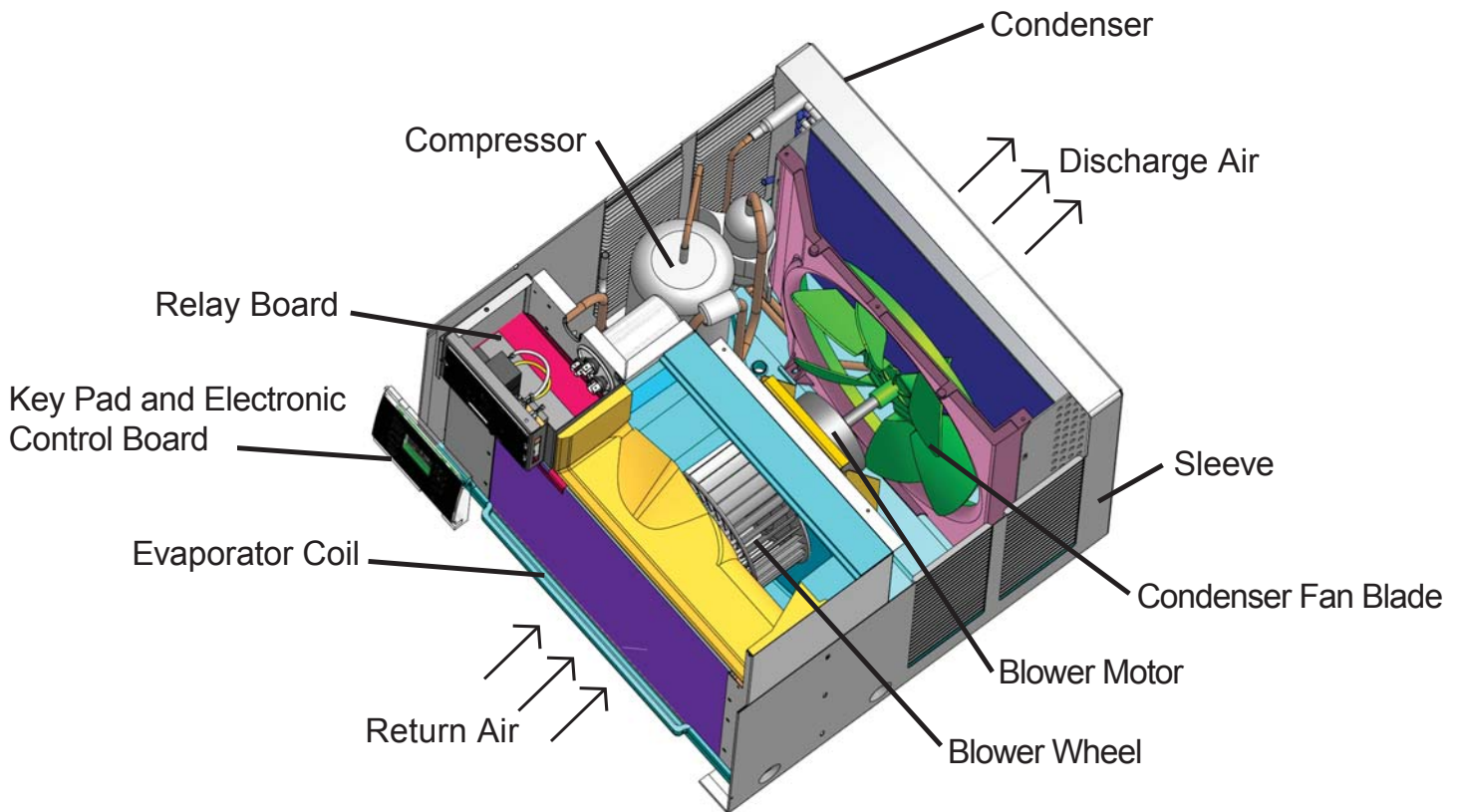

After Maintenance/Repair Start-Up Checklist & Notes

- ◆ Inspect and ensure that all components and accessories have been installed properly and that they have not been damaged during the installation progress.
- ◆ Check the condensate water drain(s) to ensure that they are adequate for the removal of condensate water, and that they meet the approval of the end user.
- ◆ Ensure that all installation instructions concerning clearances around the unit have been adhered to. Check to ensure that the unit air filter, indoor coil, and outdoor coil are free from any obstructions.
- ◆ Ensure that the circuit breaker(s) or fuse(s) and supply circuit wire size have been sized correctly. If the unit was supplied with a power supply cord, insure that it is stored properly.
- ◆ Ensure that the entire installation is in compliance with all applicable national and local codes and ordinances having jurisdiction.
- ◆ Secure components and accessories, such as a decorative front cover.
- ◆ Start the unit and check for proper operation of all components in each mode of operation.
- ◆ Instruct the owner or operator of the units operation, and the manufacturer's Routine Maintenance.

NOTE: A log for recording the dates of maintenance and/or service is recommended.

- ◆ Present the owner or operator of the equipment with the Installation & Operation Manual, all accessory installation instructions, and the name, address and telephone number of the Authorized Friedrich Warranty Service Company in the area for future reference if necessary.

This is a warm weather appliance

Your air conditioner is designed to cool in warm weather when the outside temperature is above 60°F (15.6°C) and below 115°F (46.1°C), so it won't cool a room if it is already cool outside.

Condensation is normal

Air conditioners actually pump the heat and humidity from your room to the outside. Humidity becomes water, and your air conditioner will use most of the water to keep the outside coil cool. If there is excessive humidity, there may be excess water that will drip outside. This is normal operation.

Frosting

This usually occurs because of insufficient airflow across the coils, a dirty filter, cool damp weather, or all of these. Set the SYSTEM mode to FAN ONLY  and the frost will disappear. Setting the thermostat a little warmer will probably prevent the frosting from recurring.

Noises

All air conditioners make some noise. Friedrich units are designed to operate as quietly as possible. An air conditioner mounted in a wall is quieter than one mounted in a window. It is important to ensure that the chassis seal gasket (Item 14) is properly installed (refer to installation instructions).

ROOM AIR CONDITIONER UNIT PERFORMANCE TEST DATA SHEET

DATE: _____ MODEL: _____ SERIAL: _____

	YES	NO
IS THERE A FRIEDRICH SLEEVE INSTALLED?	_____	_____
IS THERE A CHASSIS SEAL GASKET INSTALLED?	_____	_____
IS MAINTENANCE BEING PERFORMED?	_____	_____

If NO is checked use back of sheet for explanation

ELECTRICAL:

LINE VOLTAGE (STATIC) ----- VOLTS
 START UP VOLTAGE ----- VOLTS
 AMPERAGE DRAW ----- AMPS (COOL)
 AMPERAGE DRAW ----- AMPS (HEAT)

COMPRESSOR

LOCKED ROTOR AMPS ----- AMPS
 RUNNING AMPS ----- AMPS
 LOCKED ROTOR VOLTAGE ----- VOLTS

INDOOR TEMPERATURES:

INDOOR AMBIENT TEMPERATURE	-----	F		
RELATIVE HUMIDITY (RH) INDOOR	-----	%		
			COOL	HEAT
DISCHARGE AIR TEMPERATURE (INDOOR)	-----	F	-----	F
RETURN AIR TEMPERATURE (INDOOR)	-----	F	-----	F
DIFFERENTIAL	-----	F	-----	F

OUTDOOR TEMPERATURE:

OUTDOOR AMBIENT TEMPERATURE ----- F
 RH OUTDOOR ----- %

CONDENSER:

DISCHARGE AIR TEMPERATURE (OUTDOOR)	-----	F	-----	F
INTAKE AIR TEMPERATURE (OUTDOOR)	-----	F	-----	F
DIFFERENTIAL	-----	F	-----	F

APPLICATION USE ----- ROOM (RESIDENTIAL OR COMMERCIAL)

Sizing your air conditioner correctly is vital.

Sizing Guide

The following guide is based on normal room insulation, average number of sun-exposed windows and two-person occupancy

FT ²	Btu/h
100-150	5,000
150-250	6,000
250-300	7,000
300-350	8,000
350-400	9,000
400-450	10,000
450-550	12,000
550-700	14,000
700-1,000	18,000
1,000-1,200	21,000
1,200-1,400	23,000
1,400-1,600	25,000
1,600-1,900	28,000
1,900-2,700	36,000

This is a general guide.
 Please consult manual J or M for exact load calculations.

1. If heavily shaded, reduce capacity 10%.
2. If very sunny, add 10%.
3. Add 500 BTU/H per person over 2 people.
4. Add 4,000 BTU/H if area is a kitchen.

Due to variations in room design, climate zone and occupancy, larger areas may require the use of multiple units to provide the optimal cooling solution.

How to Check the Diagnostic Codes

See codes chart on next page.

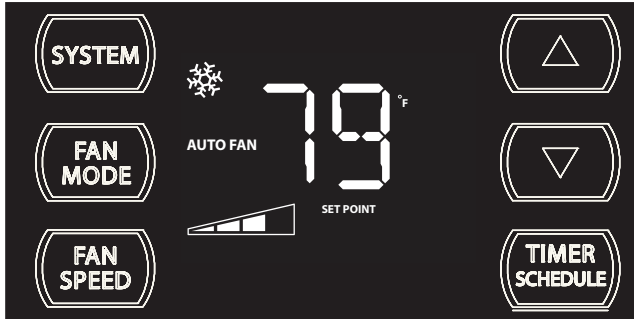

To check the active system errors, press the **FAN SPEED** & **▲** keys for 3 sec.



An "E" will appear in the display. Use the **▲** or **▼** keys to scroll through any system errors. Only active errors will be shown. The display error mode will time out in 15 seconds with no key activity.



Press the **▲** key to view the next error. Press the SELECT key to exit.

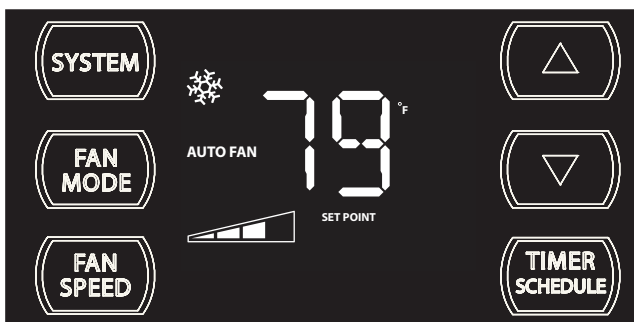

Normal display.

Erasing the Diagnostic Codes

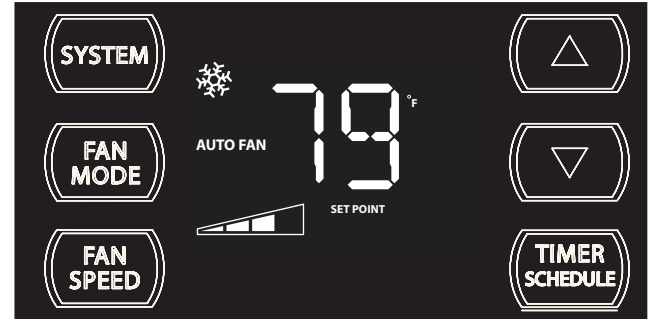

Press and hold the **TIMER SCHEDULE** and **▲** buttons simultaneously for 3 sec.



The "E" will blink for 3 seconds.

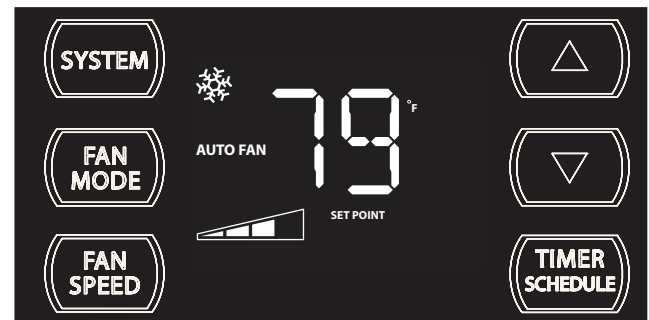

After the "E" blinks for 3 seconds, the display returns to normal.

ERROR CODES

Error Code	Problem	Control Board's Action
1	Front Panel Button Stuck For More Than 20 Seconds	Continue to monitor for "OPEN" (Unstuck) switch. Do not process switch input.
2	Input Voltage Out of Specification (103 - 127 / 187 - 253)	Open all relays until voltage is back within specs. Resume operation
3	Indoor Temperature Sensor is Open or Shorted	Set temp to 75°F in COOLING or 68°F in HEATING. Unit continues to operate
4	Indoor Coil Temperature Sensor is Open or Shorted	Control Board sets temp to a default of 40°F. Override sensor. Unit continues to operate.
5	Outdoor Coil Temperature Sensor is Open or Shorted	Sets temp to 20°F. Override sensor. Continue operation. Use Elec Heat if available for HEATING. If not available use HEAT PUMP if outdoor temp allows.
6	Outdoor Coil > (grater than) 175 F	Shut down for 5 min. Resume operation for 3 min. Continues to monitor. If test fails 3 times, the unit operation is locked out. Unplug and replug to reset.
7	Indoor Coil < (less than) 30 F for 2 consecutive minutes	Turn compressor off. Run High Fan speed. When coil temp reaches 45°F resume operation after lockout time.
8	Unit Cycles > (grater than) 9 Times per hour	Continue operation. Continue to monitor. Take no action. Log Only.
9	Unit Cycles < (less than) 3 Times per Hour	Continue operation. Continue to monitor. Take no action. Log Only.
10	Room Freeze Protection	Only used if Electric Heat is available. Run High Speed and Electric heat until room temp reaches 46°F. Display "FRZ" during operation. Logged Only
11	WallStat Problem or Connection Issue	Unit operates based on standard t-stat connection. If miswired, unit will not operate. (See pages 32 and 68)
12	Not Applicable	Not Applicable
13	Not Applicable	Not Applicable
14	Discharge Air Temperature Sensor is Open or Shorted	Override Sensor. Set temp to 75°F. Continue to monitor. Set error code 14 ON.
15	Not Applicable	Not Applicable
16	Temperature Beyond Operating Limits	Ambient temp < (less than) 0°F and ambient temp > (greater than) 130°F. Set error code 16 ON. When cleared return unit to normal.
17	Equipment Doesn't Meet Minimum Configuration	Must have compressor enabled and at least 2 fan speeds
18	Not Applicable	Not Applicable
19	Not Applicable	Not Applicable
20	Not Applicable	Not Applicable
21	Not Applicable	Not Applicable
22	Outdoor Coil Temperature < 30 F for 2 consecutive Minutes	Unit will use electric heat to satisfy heating demands until temp is greater than 45°F. Unit must be a Heat Pump with electric heat.
23	Not Applicable	Not Applicable
24	Not Applicable	Not Applicable

Key Sequence	Action
To Access Error Codes	Press the fan speed and ▲ key for 3 seconds
Reset Error Codes & Error History	Press ▲ + timer/schedule for 3 seconds

When you have entered the Error Codes section, an "E" will appear. Use the up ▲ and down ▼ keys to scroll through error codes. Only active error codes will display.

Test Mode

This function is used to test the compressor operation. By turning it on, it allows the service technician to bypass the compressor's 3 minute time delay.

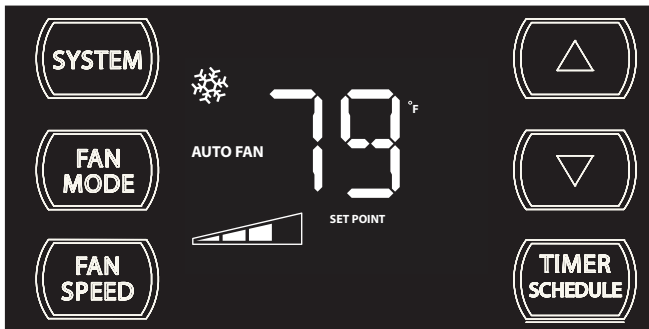

Press the **FAN MODE**, **FAN SPEED**, **▲** & **TIMER SCHEDULE** buttons simultaneously for 3 seconds. This will activate the test mode.

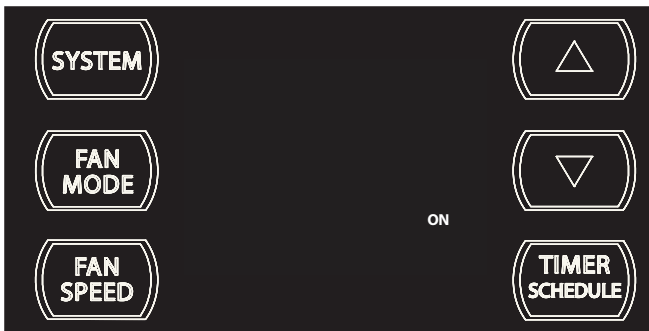

The ON icon will appear for 5 seconds and the display will then revert to the normal display. The test mode will time out after 1 hour. To cancel test mode, unplug and replug the power cord.



Normal display.

GENERAL TROUBLESHOOTING TIPS

Problem	Possible Cause	Possible Solution
Unit does not operate.	The unit is turned to the off position, or the thermostat is satisfied.	Turn the unit to the on position and raise or lower temperature setting (as appropriate) to call for operation.
	The LCDI power cord is unplugged.	Plug into a properly grounded 3 prong receptacle. See "Electrical Rating Tables" on pg. 6 for the proper receptacle type for your unit.
	The LCDI power cord has tripped (Reset button has popped out).	Press and release RESET (listen for click; Reset button latches and remains in) to resume operation.
	The circuit breaker has tripped or the supply circuit fuse has blown.	Reset the circuit breaker, or replace the fuse as applicable. If the problem continues, contact a licensed electrician.
	There has been a local power failure.	The unit will resume normal operation once power has been restored.
Unit Trips Circuit Breaker or Blows Fuses.	Other appliances are being used on the same circuit.	The unit requires a dedicated outlet circuit, not shared with other appliances.
	An extension cord is being used.	Do NOT use an extension cord with this or any other air conditioner.
	The circuit breaker or time-delay fuse is not of the proper rating.	Replace with a circuit breaker or time-delay fuse of the proper rating. See "Electrical Rating Tables" on pg. 6 for the proper circuit breaker/fuse rating for your unit. If the problem continues, contact a licensed electrician.
LCDI Power Cord Trips (Reset Button Pops Out).	The LCDI power cord can trip (Reset button pops out) due to disturbances on your power supply line.	Press and release RESET (listen for click; Reset button latches and remains in) to resume normal operation.
	Electrical overload, overheating, or cord pinching can trip (Reset button pops out) the LCDI power cord.	Once the problem has been determined and corrected, press and release RESET (listen for click; Reset button latches and remains in) to resume normal operation.
	NOTE: A damaged power supply cord must be replaced with a new power supply cord obtained from the product manufacturer and must not be repaired.	
Unit Does Not Cool/Heat Room Sufficiently, Or Cycles On And Off Too Frequently.	The return/discharge air grille is blocked.	Ensure that the return and/or discharge air paths are not blocked by curtains, blinds, furniture, etc.
	Windows or doors to the outside are open.	Ensure that all windows and doors are closed.
	The temperature is not set at a cool enough/warm enough setting.	Adjust the Temperature control to a cooler or warmer setting as necessary.
	The filter is dirty or obstructed.	Clean the filter, (See Routine Maintenance), or remove obstruction.
	The indoor coil or outdoor coil is dirty or obstructed.	Clean the coils, (See Routine Maintenance), or remove obstruction.
	There is excessive heat or moisture (cooking, showers, etc.) in the room.	Be sure to use exhaust vent fans while cooking or bathing and, if possible, try not to use heat producing appliances during the hottest part of the day.
	The temperature of the room you are trying to cool is extremely hot.	Allow additional time for the air conditioner to cool off a very hot room.

GENERAL TROUBLESHOOTING TIPS (CONTINUED)

Problem	Possible Cause	Possible Solution
Unit Does Not Cool/Heat Room Sufficiently, Or Cycles On And Off Too Frequently (continued).	The outside temperature is below 60° F (16° C).	Do not try to operate your air conditioner in the cooling mode when the outside temperature is below 60° F (16° C). The unit will not cool properly, and the unit may be damaged.
	The digital control is set to fan cycling mode.	Since the fan does not circulate the room air continuously at this setting, the room air does not mix as well and hot (or cold) spots may result. Using the continuous fan setting is recommended to obtain optimum comfort levels.
	The air conditioner has insufficient cooling capacity to match the heat gain of the room.	Check the cooling capacity of your unit to ensure it is properly sized for the room in which it is installed. Room air conditioners are not designed to cool multiple rooms.
	The air conditioner has insufficient heating capacity to match the heat loss of the room.	Check the heating capacity of your unit. Air conditioners are sized to meet the cooling load, and heater size is then selected to meet the heating load. In extreme northern climates, room air conditioners may not be able to be used as a primary source of heat.
Unit Runs Too Much.	This may be due to an excessive heat load in the room.	If there are heat producing appliances in use in the room, or if the room is heavily occupied, the unit will need to run longer to remove the additional heat.
	It may also be due to an improperly sized unit.	Be sure to use exhaust vent fans while cooking or bathing and, if possible, try not to use heat producing appliances during the hottest part of the day.
	This may be normal for higher efficiency (EER) air conditioners.	The use of higher efficiency components in your new air conditioner may result in the unit running longer than you feel it should. This may be more apparent, if it replaced an older, less efficient, model. The actual energy usage, however, will be significantly less when compared to older models.
	You may notice that the discharge air temperature of your new air conditioner may not seem as cold as you may be accustomed to from older units. This does not, however, indicate a reduction in the cooling capacity of the unit.	The energy efficiency ratio (EER) and cooling capacity rating (Btu/h) listed on the unit's rating plate are both agency certified.

COOLING ONLY ROOM AIR CONDITIONERS: TROUBLESHOOTING TIPS

Problem	Possible Cause	Action
Compressor does not run	Low voltage	Check voltage at compressor. 115V & 230V units will operate at 10% voltage variance
	T-stat not set cold enough or inoperative or electronic control board is bad	Set t-stat to coldest position. Test t-stat & replace if inoperative
	Compressor hums but cuts off on overload	Hard start compressor. Direct test compressor. If compressor starts, add starting components
	Open or shorted compressor windings	Check for continuity & resistance
	Open overload	Test overload protector & replace if inoperative
	Open capacitor	Test capacitor & replace if inoperative
	Inoperative system switch, thermistor or electronic board	Test for continuity in all positions. Replace if inoperative switch or electronic board.
Broken, loose or incorrect wiring	Refer to appropriate wiring diagrams to check wiring	

Problem	Possible Cause	Action
Fan motor does not run	Inoperative system button	Test button & replace if inoperative
	Broken, loose or incorrect wiring	Refer to applicable wiring diagram
	Open capacitor	Test capacitor & replace if inoperative
	Fan speed switch open	Test switch & replace if inoperative
	Inoperative fan motor	Test fan motor & replace if inoperative (be sure internal overload has had time to reset)

Problem	Possible Cause	Action
Does not cool or only cools slightly	Undersized unit	Refer to industry standard sizing chart
	Thermistor or electronic board is bad, T-stat open or inoperative	Set to coldest position. Test t-stat or electronic control board & replace if necessary.
	Dirty filter	Clean as recommended in Owner's Manual
	Dirty or restricted condenser or evaporator coil	Use pressure wash or biodegradable cleaning agent to clean
	Poor air circulation	Adjust discharge louvers. Use high fan speed
	Fresh air or exhaust air door open on applicable models	Close doors. Instruct customer on use of this feature
	Low capacity - undercharge	Check for leak & make repair
	Compressor not pumping properly	Check amperage draw against nameplate. If not conclusive, make pressure test

COOLING ONLY ROOM AIR CONDITIONERS: TROUBLESHOOTING TIPS

Problem	Possible Cause	Action
Unit does not run	Fuse blown or circuit tripped	Replace fuse, reset breaker. If repeats, check fuse or breaker size. Check for shorts in unit wiring & components
	Power cord not plugged in	Plug it in
	System switch in "OFF" position	Set switch correctly
	Inoperative system switch or open electronic control board	Test for continuity
	Loose or disconnected wiring at switch, control board or other components	Check wiring & connections. Reconnect per wiring diagram

Problem	Possible Cause	Action
Evaporator coil freezes up	Dirty filter	Clean as recommended in Owner's Manual
	Restricted airflow	Check for dirty or obstructed coil. Use pressure wash or biodegradable cleaning agent to clean
	Inoperative t-stat or thermistors	Test for continuity
	Short of refrigerant	De-ice coil & check for leak
	Inoperative fan motor	Test fan motor & replace if inoperative
	Partially restricted capillary tube	De-ice coil. Check temp. differential (delta T) across coil. Touch test coil return bends for same temp. Test for low running current

Problem	Possible Cause	Action
Compressor runs continually & does not cycle off	Excessive heat load	Unit undersized. Test cooling performance & replace with larger unit if needed
	Restriction in line	Check for partially iced coil & check temperature split across coil
	Refrigerant leak	Check for oil at silver soldered connections. Check for partially iced coil. Check split across coil. Check for low running amperage
	Compressor relay or T-stat contacts stuck	Check operation of t-stat and relay. Replace if contacts remain closed.
	T-stat incorrectly wired	Refer to appropriate wiring diagram
	Thermistor shorted	Replace thermistor or electronic control board

Problem	Possible Cause	Action
T-stat does not turn unit off	Compressor relay contacts stuck	Replace electronic control board
	Temperature set at coldest point	Turn to higher temp. setting to see if unit cycles off. If not, replace control board
	Incorrect wiring	Refer to appropriate wiring diagrams
	Unit undersized for area to be cooled	Refer to industry standard sizing chart

COOLING ONLY ROOM AIR CONDITIONERS: TROUBLESHOOTING TIPS

Problem	Possible Cause	Action
Compressor runs for short periods only. Cycles on overload	Overload inoperative. Opens too soon	Check operation of unit. Replace overload if system operation is satisfactory
	Compressor restarted before system pressures equalized	Allow a minimum of 2 minutes to allow pressures to equalize before attempting to restart. Instruct customer of waiting period
	Low or fluctuating voltage	Check voltage with unit operating. Check for other appliances on circuit. Air conditioner should be in separate circuit for proper voltage & fused separately
	Incorrect wiring	Refer to appropriate wiring diagram
	Shorted or incorrect capacitor	Check by substituting a known good capacitor of correct rating or test cap
	Restricted or low air flow through condenser coil or evaporator coil	Check for proper fan speed or blocked coils
	Compressor running abnormally hot	Check for kinked discharge line or restricted condenser. Check amperage

Problem	Possible Cause	Action
Unit does not turn on	Incorrect wiring	Refer to appropriate wiring diagram
	Defective thermistor	Replace thermistor or electronic control board

Problem	Possible Cause	Action
Noisy operation	Poorly installed	Refer to Installation Manual for proper installation
	Fan blade striking chassis	Reposition - adjust motor mount
	Compressor vibrating	Check that compressor grommets have not deteriorated. Check that compressor mounting parts are not missing
	Improperly mounted or loose cabinet parts refrigerant tubes	Check assembly & parts for looseness, rubbing & rattling. Correct as needed

Problem	Possible Cause	Action
Water leaks into the room	Evaporator drain pan overflowing	Clean obstructed drain trough
	Condensation forming underneath base pan	Evaporator drain pan broken or cracked. Reseal or replace. No chassis gasket installed. Install chassis gasket
	Poor installation resulting in rain entering the room	Check installation instructions. Reseal as required
	Condensation on discharge grille louvers	Dirty evaporator coil. Use pressure wash or biodegradable cleaning agent to clean. Environmental phenomena: point supply louvers upward
	Chassis gasket not installed	Install gasket, per Installation manual
	Downward slope of unit is too steep inward	Refer to installation manual for proper installation

COOLING ONLY ROOM AIR CONDITIONERS: TROUBLESHOOTING TIPS

Problem	Possible Cause	Action
Water "spitting" into room	Sublimation: When unconditioned saturated, outside air mixes with conditioned air, condensation forms on the cooler surfaces	Ensure that foam gaskets are installed in between window panes & in between the unit & the sleeve. Also, ensure that fresh air/exhaust vents (on applicable models) are in the closed position & are in tact
	Downward pitch of installation is too steep towards back of unit	Follow installation instructions to ensure that downward pitch of installed unit is no less than 1/4" & no more than 3/8"
	Restricted coil or dirty filter	Clean & advise customer of periodic cleaning & maintenance needs of entire unit

Problem	Possible Cause	Action
Excessive moisture	Insufficient air circulation thru area to be air conditioned	Adjust louvers for best possible air circulation
	Oversized unit	Operate in "MoneySaver" position
	Inadequate vapor barrier in building structure, particularly floors	Advise customer

Problem	Possible Cause	Action
T-stat or thermistor short cycles	Defective thermistor	Replace thermistor or electronic control board
	Plenum gasket not sealing, allowing discharge air to short cycle t-stat	Check gasket. Reposition or replace as needed
	Restricted coil or dirty filter	Clean & advise customer of periodic cleaning & maintenance needs of entire unit

Problem	Possible Cause	Action
Prolonged off cycles	Defective thermistor	Replace thermistor or electronic control board

Problem	Possible Cause	Action
Outside water leaks	Evaporator drain pan cracked or obstructed	Repair, clean or replace as required
	Water in compressor area	Detach shroud from pan & coil. Clean & remove old sealer. Reseal, reinstall & check
	Obstructed condenser coil	Use pressure wash or biodegradable cleaning agent to clean
	Fan blade/slinger ring improperly positioned	Adjust fan blade to 1/2" of condenser coil fin pack

HEAT / COOL ONLY ROOM AIR CONDITIONERS: TROUBLESHOOTING TIPS

Problem	Possible Cause	Action
Room temperature uneven (Heating cycle)	Bad room ambient thermistor	Check resistance and error codes
	Fan speed too low	Set at higher fan speed
	Opened doors or windows	Close them

Problem	Possible Cause	Action
*Does not heat adequately	Opened doors or windows	Close doors or windows.
	Dirty filter	Clean as recommended in Owner's Manual
	Unit undersized	Check heat rise across coil. If unit operates efficiently, check if insulation can be added to attic or walls. If insulation is adequate, recommend additional unit or larger one
	Heater hi-limit control cycling on & off	Check for adequate fan air across heater. Check control for open at 110°F & close at 100°F
	Shorted or opened heater	Ohmmeter/continuity check
	Incorrect wiring	Check applicable wiring diagram

* NOTE: Heater size on the EQ08M11 is: 1.15 KW.

ELECTRONIC CONTROLS COOL ONLY

SQ05N10-A, SQ06N10-A, SQ08N10-A, SQ10N10-A

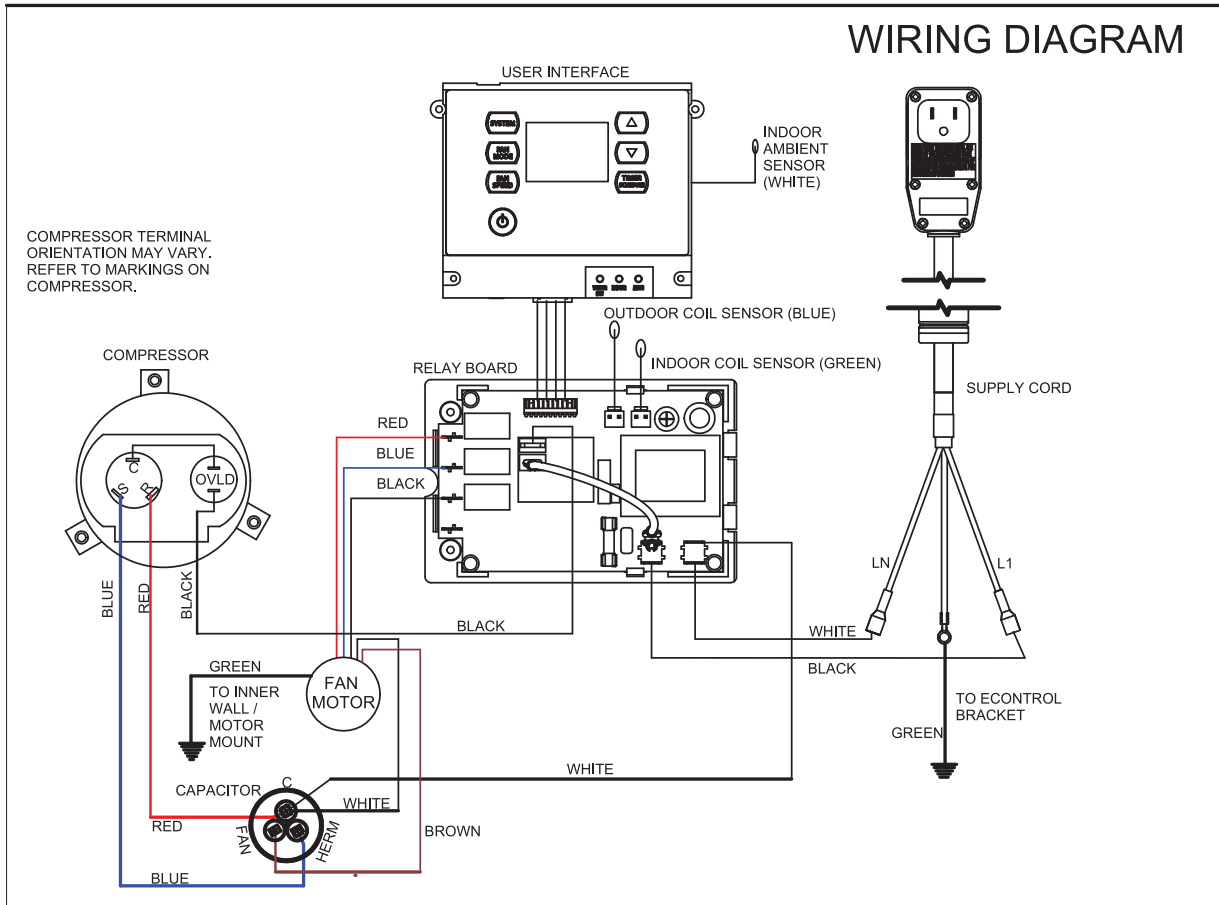

SCHEMATIC

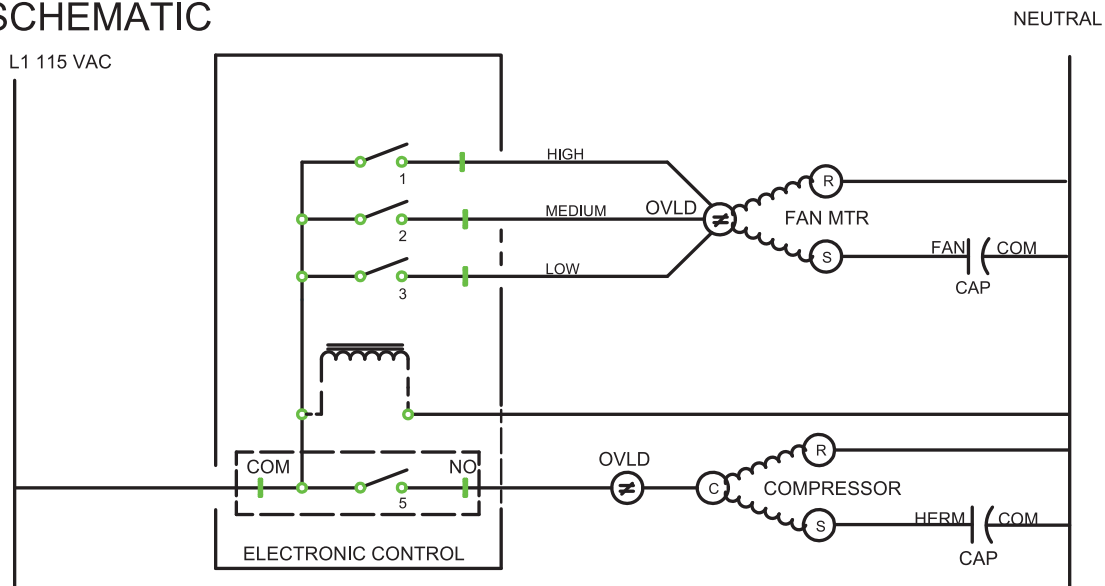

PART NO. 92120001	REV. 01
----------------------	------------

THERMISTORS' RESISTANCE VALUES
(This Table Applies to All Thermistors)

TEMP (F)	RESISTENCE (K Ohms)	TEMP (F)	RESISTENCE (K Ohms)
0	56.4452	81	9.2133
5	49.6839	82	9.0275
10	43.8591	83	8.8459
15	38.8118	84	8.6683
20	34.4303	85	8.4947
25	30.6103	86	8.3250
26	29.9068	87	8.1593
27	29.2218	88	7.9973
28	28.5546	89	7.8388
29	27.9048	90	7.6839
30	27.2717	91	7.5324
31	26.6550	92	7.3841
32	26.0540	93	7.2391
33	25.4698	94	7.0973
34	24.9004	95	6.9586
35	24.3454	96	6.8232
36	23.8044	97	6.6906
37	23.2770	98	6.5610
38	22.7628	99	6.4341
39	22.2615	100	6.3100
40	21.7726	101	6.1885
45	19.5068	102	6.0696
50	17.5040	103	5.9533
60	14.1607	104	5.8395
65	12.7641	105	5.7283
66	12.5036	106	5.6195
67	12.2490	107	5.5129
68	12.0000	108	5.4087
69	11.7573	109	5.3065
70	11.5199	110	5.2066
71	11.2879	111	5.1088
72	11.0611	112	5.0130
73	10.8392	113	4.9192
74	10.6223	114	4.8276
75	10.4103	115	4.7378
76	10.2029	116	4.6500
77	10.0000	117	4.5639
78	9.7965	118	4.4796
79	9.5977	119	4.3971
80	9.4033	120	4.3163

INSTRUCTIONS FOR USING COOLING LOAD ESTIMATE FORM FOR ROOM AIR CONDITIONERS

(AHAM PUB. NO. RAC-1)

- A. This cooling load estimate form is suitable for estimating the cooling load for comfort air conditioning installations which do not require specific conditions of inside temperature and humidity.
- B. The form is based on an outside design temperature of 95°F dry bulb and 75°F wet bulb. It can be used for areas in the continental United States having other outside design temperatures by applying a correction factor for the particular locality as determined from the map.
- C. The form includes “day” factors for calculating cooling loads in rooms where daytime comfort is desired (such as living rooms, offices, etc.)
- D. The numbers of the following paragraphs refer to the corresponding numbered item on the form:
1. Multiply the square feet of window area for each exposure by the applicable factor. The window area is the area of the wall opening in which the window is installed. For windows shaded by inside shades or venetian blinds, use the factor for “Inside Shades.” For windows shaded by outside awnings or by both outside awnings and inside shades (or venetian blinds), use the factor for “Outside Awnings.” “Single Glass” includes all types of single thickness windows, and “Double Glass” includes sealed airspace types, storm windows, and glass block. Only one number should be entered in the right hand column for Item 1, and this number should represent **only the exposure with the largest load.**
 2. Multiply the total square feet of **all** windows in the room by the applicable factor.
 - 3a. Multiply the total length (linear feet) of all walls exposed to the outside by the applicable factor. Doors should be considered as being part of the wall. Outside walls facing due north should be calculated separately from outside walls facing other directions. Walls which are permanently shaded by adjacent structures should be considered “North Exposure.” Do not consider trees and shrubbery as providing permanent shading. An uninsulated frame wall or a masonry wall 8 inches or less in thickness is considered “Light Construction.” An insulated wall or masonry wall over 8 inches in thickness is considered “Heavy Construction.”
 - 3b. Multiply the total length (linear feet) of all inside walls between the space to be conditioned and any unconditioned spaces by the given factor. Do not include inside walls which separate other air conditioned rooms.
 4. Multiply the total square feet of roof or ceiling area by the factor given for the type of construction most nearly describing the particular application (use one line only.)
 5. Multiply the total square feet of floor area by the factor given. Disregard this item if the floor is directly on the ground or over a basement.
 6. Multiply the number of people who normally occupy the space to be air conditioned by the factor given. Use a minimum of 2 people.
 7. Determine the total number of watts for light and electrical equipment, except the air conditioner itself, that will be **in use** when the room air conditioning is operating. Multiply the total wattage by the factor given.
 8. Multiply the total width (linear feet) of any doors or arches which are continually open to an unconditioned space by the applicable factor.
NOTE: Where the width of the doors or arches is more than 5 feet, the actual load may exceed the calculated value. In such cases, both adjoining rooms should be considered as a single large room, and the room air conditioner unit or units should be selected according to a calculation made on this new basis.
 9. Total the loads estimated for the foregoing 8 items.
 10. Multiply the subtotal obtained in item 9 by the proper correction factor, selected from the map, for the particular locality. The result is the total estimated design cooling load in BTU per hour.
- E. For best results, a room air conditioner unit or units having a cooling capacity rating (determined in accordance with the NEMA Standards Publication for Room Air Conditioners, CN 1-1960) as close as possible to the estimated load should be selected. In general, a greatly oversized unit which would operate intermittently will be much less satisfactory than one which is slightly undersized and which would operate more nearly continuously.

COOLING LOAD ESTIMATE FORM

HEAT GAIN FROM	QUANTITY	FACTORS			BTU/Hr. (Quantity x Factor)
		DAY			
1. WINDOWS: Heat gain from the sun. Northeast _____ sq. ft. East _____ sq. ft. Southeast _____ sq. ft. South _____ sq. ft. Southwest _____ sq. ft. West _____ sq. ft. Northwest _____ sq. ft. North _____ sq. ft.		No Shades*	Inside Shades*	Outside Awnings*	(Area X Factor)
	* These factors are for single glass only. For glass block, multiply the above factors by 0.5; for double glass or storm windows, multiply the above factors by 0.8.				
		60	25	20	Use _____
		80	40	25	only _____
		75	30	20	the _____
		75	35	20	largest _____
		110	45	30	load. _____
		150	65	45	Use _____
	120	50	35	only _____	
	0	0	0	one. _____	
2. WINDOWS: Heat by conduction					
(Total of all windows.)					
Single glass	_____ sq. ft.		14		_____
Double glass or glass block	_____ sq. ft.		7		_____
3. WALLS: (Based on linear feet of wall)					
a. Outside walls		Light Construction		Heavy Construction	
North Exposure	_____ ft.	30		20	_____
Other than North exposure	_____ ft.	60		30	_____
b. Inside Walls (between conditioned and unconditioned spaces only.)		_____ sq. ft.		30	_____
4. ROOF OR CEILING: (Use one only)					
a. Roof, uninsulated	_____ sq. ft.		19		_____
b. Roof, 1 inch or more insulation	_____ sq. ft.		8		_____
c. Ceiling, occupied space above	_____ sq. ft.		3		_____
d. Ceiling, insulated, with attic space above	_____ sq. ft.		5		_____
e. Ceiling, uninsulated, with attic space above	_____ sq. ft.		12		_____
5. Floor: (Disregard if floor is directly on ground or over a basement.)	_____ sq. ft.		3		_____
6. NUMBER OF PEOPLE	_____		600		_____
7. LIGHTS AND ELECTRICAL EQUIPMENT IN USE	_____ watts		3		_____
8. DOORS AND ARCHES CONTINUOUSLY OPENED TO UNCONDITIONED SPACE: (TOTAL LINEAR FEET OF WIDTH.)	_____ ft.		300		_____
9. SUBTOTAL	*****		*****		_____
10. TOTAL COOLING LOAD (BTU per hour to be used for selection of room air conditioner(s).)					
		_____ Total in Item 9 X _____	(Factor from Map) =		_____

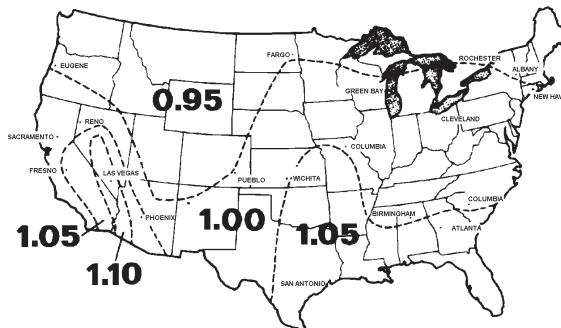

HEAT LOAD FORM

The heat load form on the following page may be used by servicing personnel to determine the heat loss of a conditioned space and the ambient winter design temperatures in which the unit will heat the calculated space.

The upper half of the form is for computing the heat loss of the space to be conditioned. It is necessary only to insert the proper measurements on the lines provided and multiply by the given factors, then add this result for the total heat loss in BTU/Hr./°F.

The BTU/Hr. per °F temperature difference is the 70°F inside winter designed temperature minus the lowest outdoor ambient winter temperature of the area where the unit is installed. This temperature difference is used as the multiplier when calculating the heat loss.

The graph shows the following:

Left Hand Scale	Unit capacity BTU/Hr. or heat loss BTU/Hr.
Bottom Scale	Outdoor ambient temperature, base point.
Heat Pump Model	BTU/Hr. capacity heat pump will deliver at outdoor temperatures.
Balance Point	Maximum BTU/Hr. heat pump will deliver at indicated ambient temperature.

Following is an example using the heat load form:

A space to be conditioned is part of a house geographically located in an area where the lowest outdoor ambient winter temperature is 40°F. The calculated heat loss is 184 BTU/Hr./°F.

Subtract 40°F (lowest outdoor ambient temperature for the geographical location) from 70°F (inside design temperature of the unit) for a difference of 30°F. Multiply 184 by 30 for a 5500 BTU/Hr. total heat loss for the calculated space.

On the graph, plot the base point (70°) and a point on the 40°F line where it intersects with the 5500 BTU/Hr. line on the left scale. Draw a straight line from the base point 70 through the point plotted at 40°F. This is the total heat loss line.

Knowing that we have a 5500 BTU/Hr. heat loss, and we expect that our heat pump will maintain a 70°F inside temperature at 40°F outdoor ambient, we plot the selected unit capacity BTU/Hr. of the unit between 35° and 60° on the graph and draw a straight line between these points. Where the total heat loss line and the unit capacity line intersect, read down to the outdoor ambient temperature scale and find that this unit will deliver the required BTU/Hr. capacity to approximately 30°F.

HEATING LOAD FORM FRIEDRICH ROOM UNIT HEAT PUMPS

	BTU/HR PER °F TEMP. DIFFERENCE
WALLS: (Linear Feet)	
2" Insulation	Lin. Ft. x 1.6
Average	Lin. Ft. x 2.6
WINDOWS & DOORS (Area, sq. ft.)	
Single Glass:	Sq. Ft. x 1.13
Double Glass:	Sq. Ft. x 0.61
INFILTRATION - WINDOWS & DOORS: AVG.	Lin. Ft. x 1.0
Loose	Lin. Ft. x 2.0
CEILING: (Area, Sq. Ft.)	
Insulated (6")	Sq. Ft. x 0.07
Insulated (2")	Sq. Ft. x 0.10
Built-up Roof (2" insulated)	Sq. Ft. x 0.10
Built-up Roof (1/2" insulated)	Sq. Ft. x 0.20
No Insulation	Sq. Ft. x 0.33
FLOOR: (Area, Sq. Ft.)	
Above Vented Crawl space	
Insulated (1:)	Sq. Ft. x 0.20
Uninsulated	Sq. Ft. x 0.50
* Slab on Ground	Lin. Ft. x 1.70
1" Perimeter insulation	Lin. Ft. x 1.00
* Based on Linear Feet of outside wall	TOTAL HEAT LOSS PER °F BTU/HR/°F

Multiply total BTU/HR/°F X 30 and plot on the graph below at 40°F. Draw a straight line from the 70 base point thru the point plotted at 40°F. The intersection of this heat loss line with the unit capacity line represents the winter design heating load.

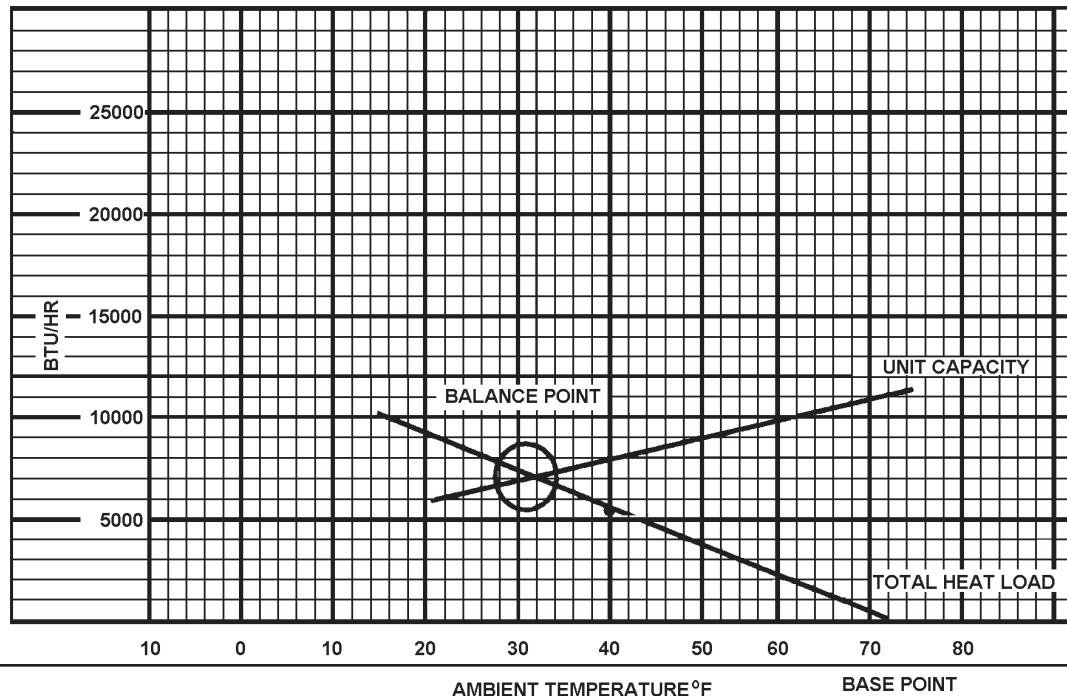

Kühl-Q Chassis 2012 Parts List

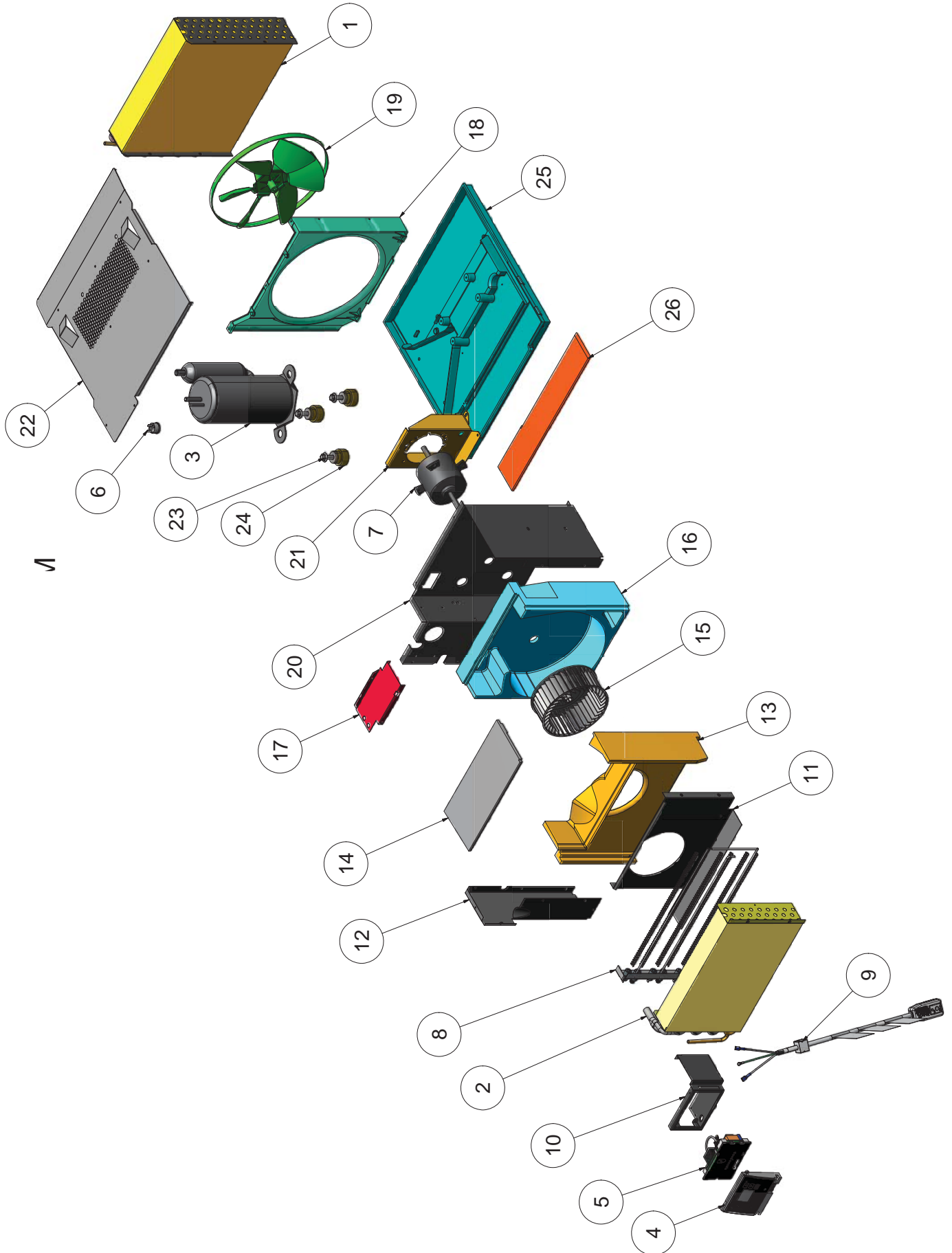

1

Kühl-Q Units' 2012 Parts List

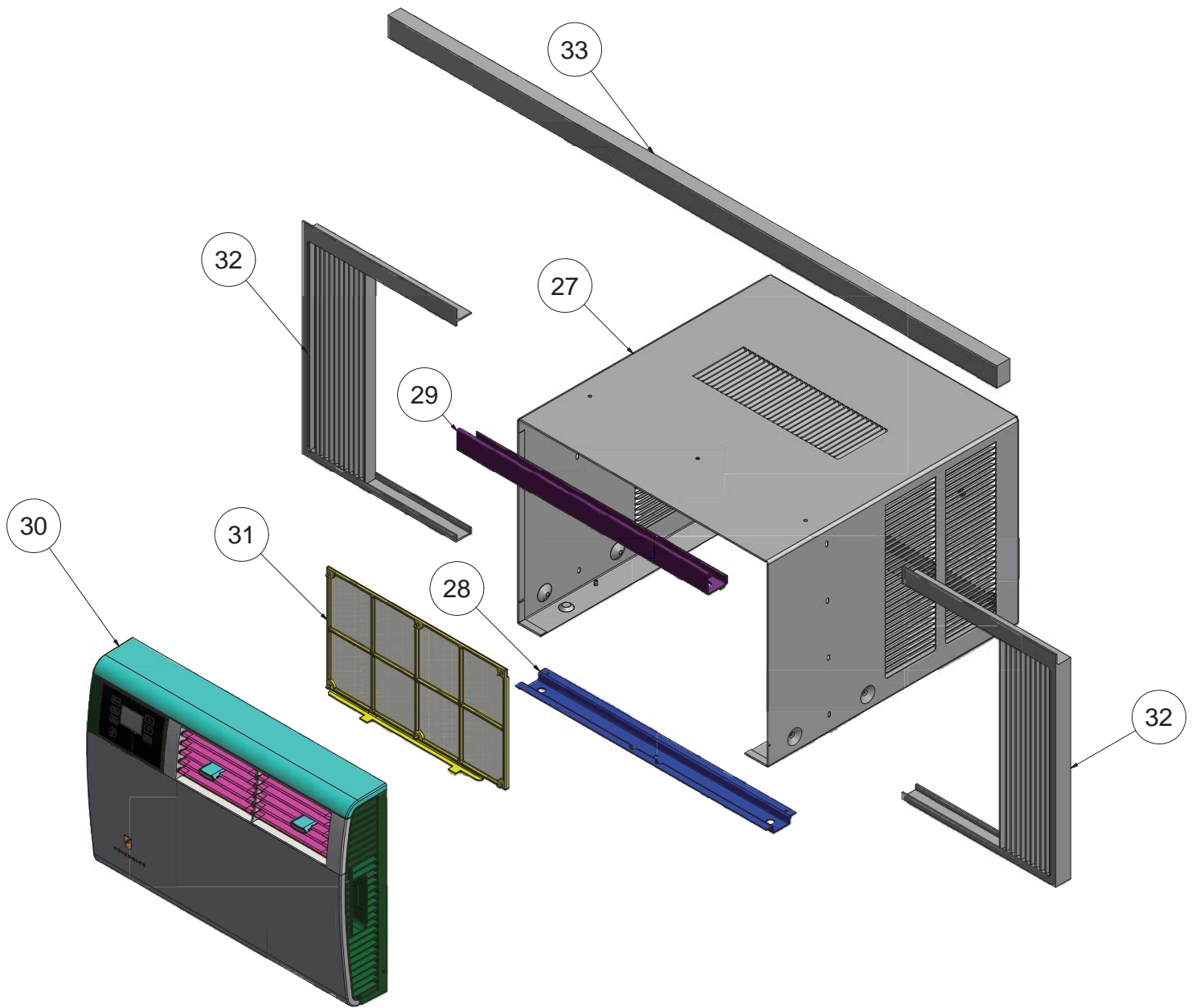

Kühl Q-Chassis Service Parts List

Item #	COMPONENT	COMPONENT DESCRIPTION	EQ08N11-A	SQ05N10-A	SQ06N10-A	SQ08N10-A	SQ10N10-A
1	61600523	CONDENSOR COIL				1	1
1	61600522	CONDENSOR COIL	1	1	1		
2	61600274	EVAPORATOR COIL		1	1		1
2	61600275	EVAPORATOR COIL	1			1	
3	61718107	KIT COMPR REPLMT 62200118	1			1	
3	61718109	KIT COMPR REPLMT 62200007					1
3	61718112	KIT COMPR REPLMT 62200006		1	1		
4	62601028	KIT USER INTERFACE RPLMNT SVC KUHL SQ		1	1	1	1
4	62601030	KIT USER INTERFACE RPLMNT SVC KUHL EQ	1				
5	62601024	KIT E-CNTL SERV COOL-EH 3SP KUHL Q	1				
5	62601023	KIT E-CNTL SERV COOL 3SP KUHL Q		1	1	1	1
6	61764594	OVERLOAD PROTECTOR B400-150-241A FSTB					1
6	61764601	OVERLOAD PROTECTOR B260-150-241E/MRA12335-12026	1			1	
6	61764605	OVERLOAD PROTECTOR MRA12230-12008		1	1		
7	61871451	FAN MOTOR		1	1		
7	61871468	FAN MOTOR					1
7	61871501	FAN MOTOR	1			1	
8	61929611	HEATER 1.15 KW @ 115V (NXT WIRE)	1				
9	60500500	SUPPLY CORD	1	1	1	1	1
10	61923901	BRKT CONTROL MNTG XQ	1	1	1	1	1
11	61928801	PANEL BLWR FRONT EQ 2003	1				
12	61924300	PANEL, L/S EQ/XQ	1	1	1	1	1
13	61990700	BLOWER FRONT, Q 2003		1	1	1	1
14	61990701	TOP BLOWER FRONT	1	1	1	1	1
15	60610604	BLOWER WHEEL	1			1	1
15	60610606	BLOWER WHEEL		1	1		
16	61990606	SCROLL Q CHASSIS	1	1	1	1	1
17	61990500	DECK, EVAP Q CHASSIS		1	1	1	1
18	61627601	SHROUD Q'	1	1	1	1	1
19	61634001	CONDENSOR FAN		1	1		
19	61634000	CONDENSOR FAN	1			1	1
20	61597317	INNERWALL XQ		1	1	1	1
20	61597318	INNERWALL EQ	1				
21	61776903	FAN MOTOR BRACKET		1	1		
21	61776900	FAN MOTOR BRACKET	1			1	1
22	61619517	COVER TOP Q-CHASSIS VENTED	1	1	1	1	1
23	91400402	COMPRESSOR STUD	3	3	3	3	3
24	61028900	COMPRESSOR GROMMET		3	3		
24	61028901	COMPRESSOR GROMMET					3
24	61028903	COMPRESSOR GROMMET	3			3	
25	61626312	BASEPAN Q-CHASSIS		1	1	1	
25	61626313	BASEPAN Q-CHASSIS					1
25	61626314	BASEPAN Q-CHASSIS	1				
26	61638400	DRAIN PAN	1	1	1	1	1
27	61825725	ASSY OUTER SHELL KUHL Q REPLMT 2012	1	1	1	1	1
28	61627212	CHANNEL SILL SQ	1	1	1	1	1
29	61627314	SUPPORT TOP SQ		1	1	1	1
30	62400437	ASSY KIT DECORATIVE FRONT SVC KUHL Q	1	1	1	1	1
31	62400726	ASSY FILTER MESH Q	1	1	1	1	1
32	61680205	ASSY CURTAIN AND FRAME Q		1	1	1	1
33	61717300	GASKET CHASSIS SEAL (UV RES)Q	1	1	1	1	1
*	61619405	DECK (EQ08)	1				
*	61715800	COUNTER WEIGHT	2	2	2	2	2
*	60179904	CONDENSATE DRAIN VALVE	1				
*	60062720	STRAP CAPACITOR	1	1	1	1	1
*	61080530	CAPACITOR 40/5/ MF 370V 2.0		1	1		
*	61080532	CAPACITOR 45/7.5 MF 370V 2.0	1			1	
*	61080594	CAPACITOR 55/7.5 MF 370V 2.0					1
*	62601029	KIT REMOTE CONTROL RPLMNT SVC KUHL	1	1	1	1	1
*	61818523	EXPANDED METAL GRILLE PAINTED KUHLQ	1	1	1	1	1
*	60169120	SCRIPT FRIEDRICH 2010 "FESTOON"	1	1	1	1	1
*	62601027	KIT SENSOR RPLMNT SVC KUHL Q (THERMISTOR SET)	1	1	1	1	1
*	03760545	CAPILLARY TUBE		1	1		
*	03760568	CAPILLARY TUBE					1
*	03760513	CAPILLARY TUBE	1			1	
*	61834800	STRAINER .312 COIL	1	1	1	1	1
*	61828202	LIQUID DRIER	1	1	1	1	1
*	60217902	SEAL FAN MOTOR TO INNER WALL	1	1	1	1	1
*	01900235	DC-2 DRAIN KIT					
*	01109003	TOUCH UP SPRAY PAINT (12 OZ)					



Friedrich Air Conditioning Company
10001 Reunion Place, Suite 500
San Antonio, TX 78216
1-800-541-6645
www.friedrich.com

ROOM AIR CONDITIONERS LIMITED WARRANTY

FIRST YEAR

ANY PART: If any part supplied by FRIEDRICH fails because of a defect in workmanship or material within twelve months from date of original purchase, FRIEDRICH will repair the product at no charge, provided room air conditioner is reasonably accessible for service. Any additional labor cost for removing inaccessible units and/or charges for mileage related to travel by a Service Agency that exceeds 25 miles one way will be the responsibility of the owner. This remedy is expressly agreed to be the exclusive remedy within twelve months from the date of the original purchase.

SECOND THROUGH FIFTH YEAR

SEALED REFRIGERANT SYSTEM: If the Sealed Refrigeration System (defined for this purpose as the compressor, condenser coil, evaporator coil, reversing valve, check valve, capillary, filter drier, and all interconnecting tubing) supplied by FRIEDRICH in your Room Air Conditioner fails because of a defect in workmanship or material within sixty months from date of purchase, FRIEDRICH will pay a labor allowance and parts necessary to repair the Sealed Refrigeration System; **PROVIDED** FRIEDRICH will not pay the cost of diagnosis of the problem, removal, freight charges, and transportation of the air conditioner to and from the Service Agency, and the reinstallation charges associated with repair of the Sealed Refrigeration System. All such cost will be the sole responsibility of the owner. This remedy is expressly agreed to be the exclusive remedy within sixty months from the date of the original purchase.

APPLICABILITY AND LIMITATIONS: This warranty is applicable only to units retained within the Fifty States of the U.S.A., District of Columbia, and Canada. This warranty is not applicable to:

1. Air filters or fuses.
2. Products on which the model and serial numbers have been removed.
3. Products which have defects or damage which results from improper installation, wiring, electrical current characteristics, or maintenance; or caused by accident, misuse or abuse, fire, flood, alterations and/or misapplication of the product and/or units installed in a corrosive atmosphere, default or delay in performance caused by war, government restrictions or restraints, strikes, material shortages beyond the control of FRIEDRICH, or acts of God.

OBTAINING WARRANTY PERFORMANCE: Service will be provided by the **FRIEDRICH Authorized Dealer or Service Organization** in your area. They are listed at www.friedrich.com. If assistance is required in obtaining warranty performance, contact our customer support team. See above for contact information.

LIMITATIONS: THIS WARRANTY IS GIVEN IN LIEU OF ALL OTHER WARRANTIES. Anything in the warranty notwithstanding, ANY IMPLIED WARRANTIES OF FITNESS FOR PARTICULAR PURPOSE AND/OR MERCHANTABILITY SHALL BE LIMITED TO THE DURATION OF THIS EXPRESS WARRANTY. MANUFACTURER EXPRESSLY DISCLAIMS AND EXCLUDES ANY LIABILITY FOR CONSEQUENTIAL OR INCIDENTAL DAMAGE FOR BREACH OF ANY EXPRESSED OR IMPLIED WARRANTY.

Performance of Friedrich's Warranty obligation is limited to one of the following methods:

1. Repair of the unit
2. A refund to the customer for the prorated value of the unit based upon the remaining warranty period of the unit.
3. Providing a replacement unit of equal value

The method of fulfillment of the warranty obligation is at the sole discretion of Friedrich Air Conditioning.

NOTE: Some states do not allow limitations on how long an implied warranty lasts, or do not allow the limitation or exclusion of consequential or incidental damages, so the foregoing exclusions and limitations may not apply to you.

OTHER: This warranty gives you specific legal rights, and you may also have other rights which vary from state to state.

PROOF OF PURCHASE: Owner must provide proof of purchase in order to receive any warranty related services.

All service calls for explaining the operation of this product will be the sole responsibility of the consumer.

All warranty service must be provided by an **Authorized FRIEDRICH Service Agency**, unless authorized by FRIEDRICH prior to repairs being made.

(10-08)

CUSTOMER SATISFACTION and QUALITY ASSURANCE

Friedrich is a conscientious manufacturer, concerned about customer satisfaction, product quality, and controlling warranty costs. As an Authorized Service Provider you play a vital role in these areas. By adhering to the policies and procedures you provide us with vital information on each warranty repair you complete. This information is used to identify product failure trends, initiate corrective action, and improve product quality, thereby further reducing warranty expenses while increasing customer satisfaction levels.

FRIEDRICH AUTHORIZED PARTS DEPOTS

AAA Refrigeration Service

1322 24th Street, Suite B
Kenner, Louisiana 70062
504-464-7444
877-813-7444

The Gabbert Company

6868 Ardmore
Houston, Texas 77054
713-747-4110
800-458-4110

Reeve Air Conditioning, Inc.

2501 South Park Road
Hallandale, Florida 33009
954-962-0252
800-962-3383

Alamo Service Company

1450 North Flores Street
San Antonio, Texas 78212
210-227-2450
800-328-2450

Johnstone Supply of Woodside

27-01 Brooklyn Queens Expway
Woodside, New York 11377
718-545-5464
800-431-1143

Valley of the Sun

4710 W. Dewey Drive
Las Vegas, NV 89118
702-547-4900
866-259-8500

A/C Warehouse

670 Avahl Street
Honolulu, Hi 96813
808-545-3084

International Parts Depot

Traco Corp.
380 Paterson Road
Carlstadt, NJ 07072
201-939-1600

TECHNICAL SUPPORT CONTACT INFORMATION



F R I E D R I C H

FRIEDRICH AIR CONDITIONING CO.

10001 Reunion Place, Ste. 500, San Antonio, TX 78216
(210) 546-0500 877-599-5665 x 261 FAX (210) 546-0630
Email: tac@friedrich.com
www.friedrich.com

Printed in the U.S.A.



F R I E D R I C H

FRIEDRICH AIR CONDITIONING CO.

10001 Reunion Place, Ste. 500, San Antonio, TX 78216

P 210-546-0500 | **F** 210-546-0731

www.friedrich.com

Printed in the U.S.A.