

This Owner's Manual is provided and hosted by [Appliance Factory Parts](http://www.appliancefactoryparts.com).



# Bayou Classic SAB6 Owner's Manual

[Shop genuine replacement parts for Bayou Classic  
SAB6](#)



[Find Your Bayou Classic Wood or Gas Stove Parts - Select From 25 Models](#)

----- Manual continues below -----

# BAYOU CLASSIC®

MODEL  
#KAB4



MODEL  
#KAB6

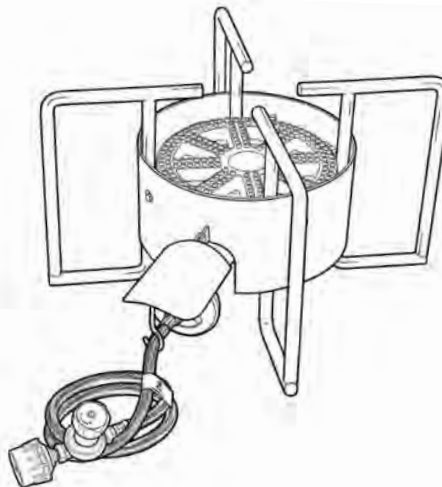

## LP GAS COOKER

# OWNER'S MANUAL

**SAFETY ALERTS, ASSEMBLY & OPERATING INSTRUCTIONS  
GENERAL MAINTENANCE & STORAGE**

This Instruction Manual contains important information necessary for the proper assembly and safe use of this appliance. You must carefully read and follow all warnings and instructions in this manual before assembling and using this appliance.

**KEEP THIS MANUAL FOR FUTURE REFERENCE**

### **⚠ WARNING ⚠**

- The maximum size cooking vessel for boiling or steaming with this cooker is 162-quart.
- Do not use a cooking vessel smaller than 14-inches diameter.
- Do not use this appliance for frying with oil/grease.

**NOT FOR COMMERCIAL USE**

For Questions and Information call us at: **1-800-864-6194** • Monday - Friday 8:00am - 5:00pm CST  
**Barbour International, Inc.** • 101 Cypress Way • Brandon, MS 39042 • [www.thebayou.com](http://www.thebayou.com)

# CONTENTS

Warnings & Dangers	1 - 7	Operating Instructions	17
Assembly Instructions	8	How to Determine Proper Amount of Liquid for Boiling or Steaming	17 - 18 18 - 19
LP Gas Cylinder Specifications	9 - 10	Boiling Instructions	
Regulator Hose Assembly	11	Steaming Instructions	20
Connecting Regulator Hose Assembly to Cooker	11	Trouble Shooting Tips	21
Connecting Regulator Hose Assembly to LP Gas Cylinder	12	Trouble Shooting Guide	22
Gas Leak Testing	12 - 13	General Maintenance and Storage	23
Pre-Cooking Check List & Positioning the Cooker	14	Care and use Instructions for Cookware	24
Lighting Instructions	15		
Burner Flame Check and How to Re-ignite Burner	16		
Turning off Cooker and Disconnecting Hose	16		

---

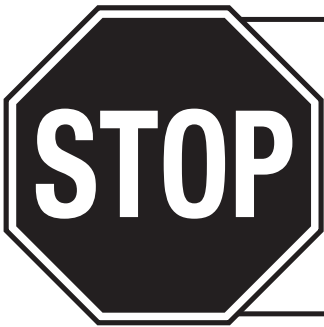

If you have a missing or damaged part, **please do not return** this item to the store.

Call **Barbour International, Inc.** for assistance:

**1-800-864-6194**

**Monday-Friday 8:00am - 5:00pm CST**

---

## LIMITED WARRANTY

Barbour International, Inc. ("Vendor") warrants to the original retail purchaser of this gas cooker and no other person, that if this gas cooker is assembled and operated in accordance with the printed instructions accompanying it, then for a period of one (1) year from the date of purchase, all parts in such gas cooker shall be free from defects in material and workmanship. Vendor may require reasonable proof of your date of purchase from an authorized retailer or distributor. Therefore, you should retain your sales slip or invoice. This Limited Warranty shall be limited to the repair or replacement of parts, which prove defective under normal use and service and which Vendor shall determine in its reasonable discretion upon examination to be defective. Before returning any parts, you should contact Vendor's Customer Service Department using the contact information listed below. If Vendor confirms, after examination, a defect covered by this Limited Warranty in any returned part, and if Vendor approves the claim, Vendor will replace such defective part without charge. If you return defective parts, transportation charges must be prepaid by you. Vendor will return replacement parts to the original retail purchaser, freight or postage prepaid.

This Limited Warranty does not cover any failures or operating difficulties due to accident, abuse, misuse, alteration, misapplication, improper installation or improper maintenance or service by you or any third party, or failure to perform normal and routine maintenance on the gas cooker, as set out in this owner's manual. In addition, the Limited Warranty does not cover damage to the finish, such as scratches, surface chips and cracks, discoloration, rust or other weather damage, after purchase.

This Limited Warranty is in lieu of all other express warranties. Vendor disclaims all warranties for products that are purchased from sellers other than authorized retailers or distributors. AFTER THE PERIOD OF THE ONE (1)-YEAR EXPRESS WARRANTY, VENDOR DISCLAIMS ANY AND ALL IMPLIED WARRANTIES, INCLUDING WITHOUT LIMITATION THE IMPLIED WARRANTIES OF MERCHANTABILITY AND FITNESS FOR A PARTICULAR PURPOSE. FURTHER, VENDOR SHALL HAVE NO LIABILITY WHATSOEVER TO PURCHASER OR ANY THIRD PARTY FOR ANY SPECIAL, INDIRECT, PUNITIVE, INCIDENTAL, OR CONSEQUENTIAL DAMAGES. Vendor assumes no responsibility for any defects caused by third parties. This Limited Warranty gives the purchaser specific legal rights; a purchaser may have other rights depending upon where he or she lives. Some jurisdictions do not allow the exclusion or limitation of special, incidental or consequential damages, or limitations on how long a warranty lasts, so the above exclusion and limitations may apply to you.

Vendor does not authorize any person or company to assume for it any other obligation or liability in connection with the sale, installation, use, removal, return, or replacement of its equipment, and no such representations are binding on Vendor.

## NOTE TO CONSUMER

This LP Gas Cooker is a specialized high pressure gas appliance having far greater heat output than traditional kitchen stoves. It is referred to as **cooker** and **appliance** in this manual and on warning tags. Same as a kitchen stove, this cooker does not have automatic thermostat controls so must be attended and monitored at all times during use.

This LP Gas Cooker is for **OUTDOOR USE ONLY for boiling or steaming!**

**Do not use a cooking vessel larger than 162-quart for boiling or steaming.**

**Do no use a cooking vessel smaller than 14" diameter on this cooker.**

**Do not use this appliance for frying.**

This cooker provides multiple cooking options such as boiling crawfish, crabs, shrimp, corn and vegetables. It is also perfect for soups, stews, gumbo, along with Low Country Boil, Booya and Homebrew.

As with any cooking appliance, care must be taken to follow all Safety Precautions and Instructions in order to achieve safe and satisfactory cooking results.



Restrict the use of this appliance to adults who can read, understand and follow the warnings and instructions in this manual, and on the cooker. Safety Alerts alone cannot eliminate the hazards that they signal. Strict compliance with these instructions, plus common sense operation, are primary accident prevention measures.



## SAFETY SYMBOLS



The symbols and boxes shown below explain what each heading means. Read and follow all of the safety warnings and instructions contained in this manual and on the cooker.

**THE PURPOSE OF THIS SAFETY ALERT SYMBOL  IS TO ATTRACT YOUR ATTENTION TO POSSIBLE HAZARDS AS YOU ASSEMBLE AND USE THIS PRODUCT.**

**WHEN YOU SEE THE SAFETY ALERT SYMBOL  PAY CLOSE ATTENTION TO THE INFORMATION WHICH FOLLOWS!**

** DANGER ** → Indicates an imminently hazardous situation which, if not avoided, will result in death or serious injury.

** WARNING ** → Hazard or unsafe practices which could result in severe property damages, personal injury, or death.

** CAUTION ** → Hazard or unsafe practices which could result in minor personal injury, product, or property damages.

Carefully read and follow all **WARNINGS, SAFETY PRECAUTIONS, ASSEMBLY and OPERATING INSTRUCTIONS** contained in this manual and on the cooker.

**DO NOT skip any of the warnings and instructions! SAVE THIS MANUAL FOR FUTURE REFERENCE.**

### **WARNING FOR YOUR SAFETY:**

**For Outdoor Use Only** (outside any enclosure)

- 1. Improper installation, adjustment, alteration, service or maintenance can cause injury or property damage.**
- 2. Read the installation, operation, and maintenance instructions thoroughly before installing or servicing this equipment.**
- 3. Failure to follow these instructions could result in fire or explosion, which could cause property damage, personal injury, or death.**

# SAFETY PRECAUTIONS AND WARNINGS

## ⚠️ WARNING ⚠️

**This cooker does not have automatic thermostat controls. Failure to follow these instructions could result in fire or explosion which could cause property damage, personal injury or death!**



### **ALWAYS**

operate in an open area a minimum of 10-ft from buildings, trees and overhangs.



### **OUTDOOR USE ONLY!**

Do not operate inside garages, carports or patios.



### **NEVER LEAVE COOKER UNATTENDED!**



### **NEVER**

use under any roof or overhang.



### **NEVER**

use on decks, boats or any combustible surface!



### **NEVER**

place flammable or combustible materials within 25-ft of cooker.



### **NEVER**

Use for frying or to fry whole turkeys.



### **NEVER!**

allow children or pets near the cooking area during and after use.



### **HOT!**

Extremely hot during and after use. Allow appliance to cool below 115°F (45°C) before cleaning or storing



### **NEVER!**

No barefeet or sandals when cooking.



### **ALWAYS**

wear protective mitts, gloves, goggles and long sleeve clothing when cooking.

**Remember: Think Safety and Use Common Sense!**

## **⚠ WARNING ⚠**

- This cooker is a high pressure gas appliance for **OUTDOOR USE ONLY**.
- This cooker does not have automatic thermostat controls so must be attended and monitored at all times during use.
- This cooker is designed to be used with very large stockpots up to 162-qt capacity for boiling or steaming. Extreme **CAUTION** must be used.
- Do not use this cooker for deep frying in any size cooking vessel. If not used properly, this 30 PSI high pressure cooker could rapidly heat cooking oil above 400°F(200°C) to the point of auto-ignition and fire; causing property damage, personal injury or death.
- This cooker must never be used to fry whole turkeys!
- If having any doubts or concerns about your ability to use this product call 800-864-6194.
- Should you still have concerns about operating this product, then do not use. Contact your dealer for return and refund.

**Remember; Think Safety and Use Common Sense!**

## **⚠ DANGER ⚠**

### **IF YOU SMELL GAS:**

1. Shut off gas to the appliance.
2. Extinguish any open flame.
3. If odor continues, keep away from the appliance and immediately call your fire department.

**FAILURE TO FOLLOW THESE INSTRUCTIONS COULD RESULT IN FIRE OR EXPLOSION WHICH COULD CAUSE PROPERTY DAMAGE, PERSONAL INJURY OR DEATH.**

## **⚠ DANGER ⚠**

- Never operate this appliance unattended. A sober, adult must attend and monitor this appliance at all times during use.
- Never operate this appliance within 10 feet (3.0m) of any structure, combustible material or other gas cylinder.
- Never operate this appliance within 25 feet (7.5m) of any flammable liquids.
- Heated liquids remain at scalding temperatures long after the cooking process. Never touch the cooking appliance until liquids have cooled to 115°F (45°C) or less.
- If a fire should occur, shut off gas to the appliance, keep away from the appliance and immediately call your local Fire Department.
- Be cautious when in close proximity to any gas appliance. Falling or tripping near the appliance, or over an appliance hose, may result in the spilling or splashing of boiling water, potentially causing personal injury and property damage.

**FAILURE TO FOLLOW THESE INSTRUCTIONS COULD RESULT IN FIRE, EXPLOSION OR BURN HAZARD, WHICH COULD CAUSE PROPERTY DAMAGE, PERSONAL INJURY OR DEATH.**

## ⚠ DANGER ⚠

### IF FIRE OCCURS

If a fire occurs **OUTSIDE THE POT** follow these steps.

- Turn off the gas supply if possible.
- Call the local Fire Department if property damage is possible.
- Attempt to extinguish using a chemical fire extinguisher specified. **A Type BC or ABC dry chemical fire extinguisher may in some cases contain the fire.**

## ⚠ WARNING ⚠



- A. **DO NOT** store a spare LP cylinder under or near a gas cooker appliance.
- B. **Never** fill the cylinder beyond 80% full.
- C. If the information in (A) and (B) are not followed exactly, a fire causing death or serious injury may occur.

## ⚠ WARNING ⚠

### PLACEMENT OF COOKER

- **This cooker shall be used OUTDOORS ONLY.** DO NOT use in a building, home, garage, balcony, porch, tent or any other enclosed area. Gas cookers shall not be used on or under apartment or condominium balcony or deck. DO NOT install or use in or on recreational vehicles and/or boats.
- DO NOT operate this LP Gas Cooker any closer than 10 feet (3m) from any combustible materials including walls or railing, or under overhead construction and tree branches as these materials could ignite should oil/grease fire occur.
- The cooker must be positioned on a level, stable, noncombustible surface such as brick, concrete or dirt. Do not position cooker on wood, asphalt or plastic which may burn, blister or melt.
- Do not use on combustible flooring or surfaces.
- Keep the cooking area clear and free of any combustible material such as household chemicals, paint, gasoline and other flammable vapors and liquids. Do not store or use gasoline or other liquid/aerosols with flammable vapors within 25 feet (7.5m) of this cooker.
- Prior to lighting the burner, check wind direction for placement of cooker **DOWNWIND** from upright LP cylinder. The cooker must be **DOWNWIND** and least 20" away from LP cylinder to keep heat away from cylinder.
- **Refer to instructions for Proper Positioning of the Cooker on page 14 in this manual.**

## ⚠️ WARNING ⚠️

### 30 PSI REGULATOR HOSE ASSEMBLY

- The pressure regulator hose assembly supplied with this appliance must be used. Clean and inspect the hose before each use of the appliance. If there is evidence of abrasion, wear, cuts or leaks, the hose must be replaced prior to the appliance being put into operation. Only use replacement regulator hose assembly #M5HPR30.

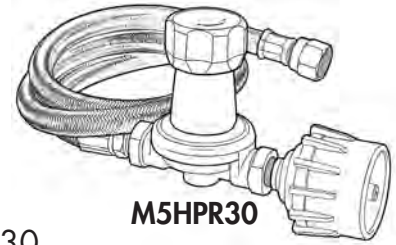

M5HPR30

**This part can be obtained by contacting Barbour International, Inc. at 1-800-864-6194.**

Replace regulator hose assembly at least every two years. Keep the fuel supply hose away from any heated surface.

- Refer to instructions for connecting regulator hose assembly to LP gas cylinder and burner on page 11 in this manual.
- Check all gas connections by following the Gas Leak Testing Instructions on pages 12-13 in this manual. Never test for gas leaks with a lighted match or open flame. DO NOT operate this cooker with a gas leak.
- Follow **Lighting Instructions** as stated in this manual on pages 15-16. Use a fireplace match or gas appliance butane lighter.
- **The valve on regulator hose assembly controls flame intensity only. It is not an ON/OFF valve.**

## ⚠️ WARNING ⚠️

### LP GAS CYLINDER

- Use only a 20 pound LP Gas Cylinder or smaller with a protective collar.
- LP (propane) gas is colorless, tasteless, heavier than air, and is both flammable and explosive. Combustion of propane consumes oxygen and produces carbon monoxide, a poisonous gas. Therefore, never operate an outdoor cooker appliance inside a building or confined area where ventilation may be restricted. Make sure the LP cylinder and the cooker are placed in an open area. DO NOT obstruct the flow of combustion and ventilation air.
- Never use a gas cylinder if it shows signs of dents, gouges, bulges, fire damage, erosion, leakage, excessive rust, or other forms of visible external damage. The cylinder may be hazardous and should be checked by a qualified liquid propane supplier.
- Never attach a gas cylinder, move or alter fittings while cooker is hot or in operation.
- Do not attempt to disconnect the regulator hose assembly while cooker is in operation.
- When cooker use is complete, always turn the LP cylinder valve OFF first, then turn the regulator control valve OFF. Turning the cylinder OFF first allows remaining gas to flow out of the regulator hose assembly before the regulator control valve is turned OFF.
- DO NOT use external electrical sources with this appliance.
- Storage of this appliance indoors is permissible only if the cylinder is disconnected and removed from the appliance and left outdoors. Cylinders must be stored outdoors out of the reach of children and must not be stored in a building, garage or any other enclosed area.

## **⚠ WARNING ⚠**

### **LP GAS CYLINDER - CONTINUED**

- The installation of this appliance must conform with local codes or, in the absence of local codes, with the National Fuel Gas Code, ANSI Z223.1/NFPA 54, Storage and Handling of Liquefied Petroleum Gases, ANSI/NFPA 58, Natural Gas and Propane Installation Code, CSA B149.1, Propane Storage and Handling, CSA B149.2, or the Standard for Recreational Vehicles, ANSI A119.2/NFPA 1192 and the Recreational Vehicle Code, CSA z240 RV Series.
- **Refer to section about LP Gas Cylinder Information on pages 10 -11 in this manual.**

## **⚠ WARNING ⚠**

### **GENERAL OPERATING**

- This appliance does not have automatic thermostat controls so must be attended and monitored at all times during use.
- This cooker is designed for use with extra large cooking vessels (stockpots) up to 162-quart capacity. Extreme CAUTION must be used when cooking with this appliance.
- Do not use cooking vessels smaller than 14-inches diameter on this cooker. Small size cooking vessels can rapidly over-heat or turn over, causing hot liquids to spill and splash; resulting in severe burns.
- Use only the regulator hose assembly that is supplied with this appliance, **Model #M5HPR30**.
- This appliance has an open flame. In sunlight or other bright light, the flame may be almost invisible. Use extreme caution keeping hands, hair and clothing away from the cooker. Do not lean over the cooker when lighting burner. Loose hair and clothing can catch fire during lighting and operation.
- After a period of storage or nonuse, check this appliance for gas leaks and burner obstructions before use. See instructions in this manual for correct procedures.
- This is an ATTENDED appliance, DO NOT leave this appliance unattended while heating water, cooking food or when hot after use (water above 115°F: 45°C). Heated liquid can remain at scalding temperatures long after cooking has ended.
- Should the burner flame go out during use, turn all gas valves off. Wait 5 minutes for gas to evacuate before re-lighting. See instructions in this manual for correct procedures.
- Hot water or steam can cause severe burns and permanent disfigurement. Use caution and common sense when operating this product and after cooking is finished.
- Keep children and pets away from the cooker at all times. Carefully monitor all activity around cooker to avoid burns or other injuries. Do not wear loose clothing or allow long hair to hang freely while lighting or using the cooker.
- This appliance will be hot during and after use. Use insulated oven mitts or gloves for protection from hot surfaces or splatter from cooking liquids. Always wear closed toe shoes while cooking with this appliance.

# ⚠ WARNING ⚠

## GENERAL OPERATING - CONTINUED

- Use caution when walking or standing near cooker as splattered liquids may have created a slick surface. Do not walk between cooker and propane tank as this creates a trip hazard. Tripping over the hose could overturn the cooker or knock cooking vessel of hot liquid from cooker causing severe burns.
- Avoid bumping of or impact with the appliance to prevent spillage or splashing of hot cooking liquid which can cause severe burns.
- DO NOT move the appliance when in use. Allow the cooking vessel to cool down to 115°F (45°C) before moving, cleaning or storing.
- Never overfill the cooking vessel with water. Overfilled cooking vessels can boil over and cause severe burns. Follow instructions in this manual for establishing proper water level.
- Sober adult operation ONLY! Read and understand this manual before using this appliance. The use of alcohol, prescription or nonprescription drugs may impair ability to properly assemble or safely operate this appliance.
- DO NOT place empty cooking vessel on the cooker while in operation as it could melt. Use caution when placing anything in cooking vessel while the appliance is in operation.
- Children can fall into a cooking vessel and drown in even a small amount of liquid. Keep cooking vessel out of reach of children. Do not store cooking vessel with liquid inside.
- When cooking, have a Type BC or ABC fire extinguisher readily accessible in case of fire.
- This appliance is not intended for and should never be used as a heater.
- Do not use this cooker for other than its intended purpose.
- Combustion by-products from the use of this product contain chemicals known to the State of California to cause cancer, birth defects, or other reproductive harm.
- Never use glassware, plastic, or ceramic cookware on this appliance.
- Only use replacement/accessory parts manufactured by Barbour International, Inc. Repairs should be performed by Barbour International, Inc.
- **If you see, smell or hear the hiss of escaping gas from the liquid propane cylinder.**
  1. Move away from liquid propane cylinder.
  2. Do not attempt to correct the problem yourself.
  3. Call your fire department.

# ASSEMBLY INSTRUCTIONS

READ ALL SAFETY WARNINGS & ASSEMBLY INSTRUCTIONS CAREFULLY BEFORE ASSEMBLING OR OPERATING YOUR COOKER. Inspect contents in the box to ensure all parts are included and undamaged.

**FOR MISSING PARTS OR ASSISTANCE, PLEASE CALL 1-800-864-6194 M-F 8am - 5pm CST.**

Proof of purchase will be required.

## TOOLS REQUIRED:

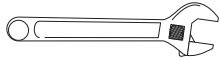

Adjustable Wrench

## PARTS INCLUDED:

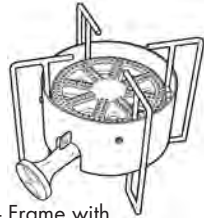

1- Frame with BG14 Burner



1- Regulator Hose Assembly #M5HPR-30



1- Air Shutter



1 - Long Bolt



1- Brass Orifice Connector



1- Spring



1- Heat Shield



1 - Nut

## COOKER ASSEMBLY

1. Remove components from the box and packing.
2. **Attach Heat Shield to Support Bar**  
Line up heat shield over hole in support bar. Slide long bolt through hole and attach nut. Wrench tighten.
3. **Attach Hose to Burner** - Refer to Connecting Regulator Hose Assembly to Cooker on page 11.

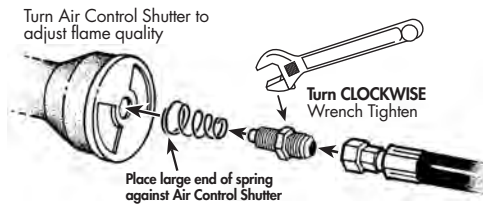

**IMPORTANT:** Must be able to turn Air Control Shutter... **DO NOT** over tighten!

### KAB4

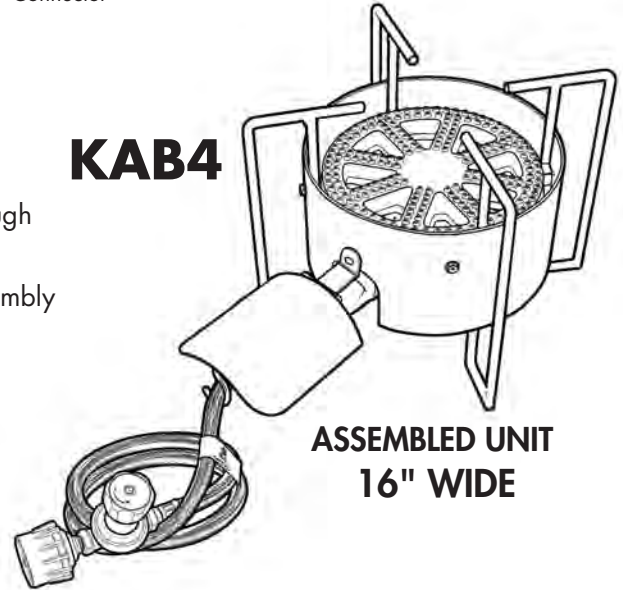

**ASSEMBLED UNIT  
16" WIDE**

## TOOLS REQUIRED:



Adjustable Wrench

## PARTS INCLUDED:

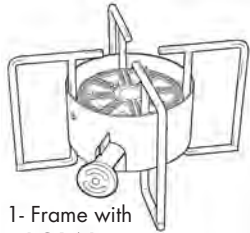

1- Frame with BG14 Burner



1- Regulator Hose Assembly #M5HPR-30



1- Air Shutter



1 - Long Bolt



1- Brass Orifice Connector



1- Spring



1- Heat Shield



1 - Nut

## COOKER ASSEMBLY

1. Remove components from the box and packing.
2. **Attach Heat Shield to Support Bar**  
Line up heat shield over hole in support bar. Slide long bolt through hole and attach nut. Wrench tighten.
3. **Attach Hose to Burner** - Refer to Connecting Regulator Hose Assembly to Cooker on page 11.

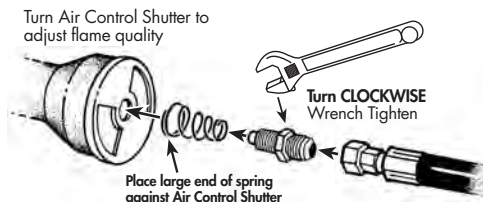

**IMPORTANT:** Must be able to turn Air Control Shutter... **DO NOT** over tighten!

### KAB6

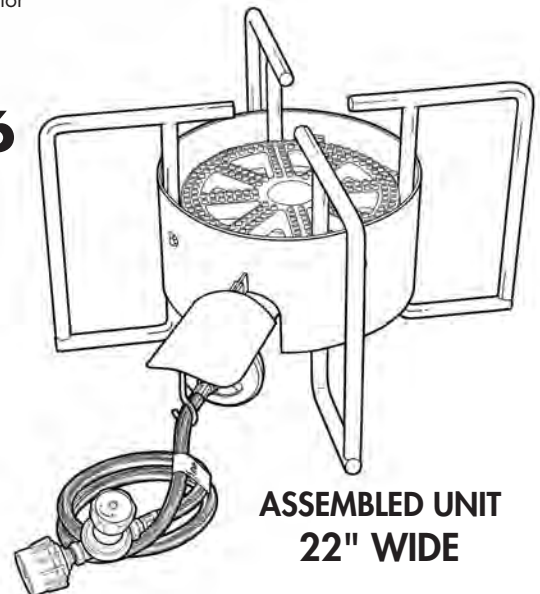

**ASSEMBLED UNIT  
22" WIDE**

# LP GAS CYLINDER SPECIFICATIONS

**! DANGER !**

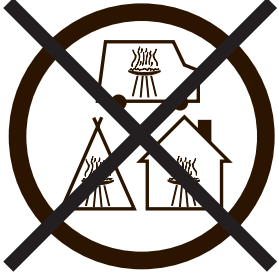

## CARBON MONOXIDE HAZARD

This appliance can produce carbon monoxide which has no odor.

Using it in an enclosed space can kill you.

Never use this appliance in an enclosed space such as a camper, tent, car or home.

**! WARNING !**

### LP GAS CYLINDER (NOT SUPPLIED WITH THIS COOKER)

The LP (Liquid Propane) gas cylinder specifically designed to be used with this cooker must have a 20 lb (9.1 kg) capacity incorporating a Type-1 cylinder valve and an over-filling protection device (OPD).

- DO NOT connect this cooker to an existing #510 POL cylinder valve with Left Hand Threads. The Type-1 valve can be identified with the large external threads on the valve outlet.
- DO NOT connect to a propane cylinder exceeding this capacity.
- DO NOT connect to a cylinder that uses any other type of valve connection device.

## LP GAS CYLINDER

To check your local codes, see your local LP gas dealer or natural gas company. This cooker is not intended to be connected to a natural gas supply line.

When purchasing or exchanging a cylinder for your gas cooker, it must be constructed and marked in accordance with the specifications for LP gas cylinders by the U.S. Department of Transportation (DOT) or the National Standard of Canada, CAN/CSA-B339, Cylinders, Spheres and Tubes for the Transportation of Dangerous Goods as applicable with a listed over-filling device (OPD).

### The cylinder must also be equipped with:

- A shut-off valve terminating in a Type-1 gas cylinder valve outlet.
- A Type-1 valve that prevents gas flow until a positive seal is obtained.
- An arrangement for vapor withdrawal.
- A collar to protect the cylinder shut-off valve.
- A safety relief device having direct communication with the vapor space of the cylinder.
- A listed Over-filling Prevention Device (OPD).
- A protective cap on cylinder Type-1 Outlet.

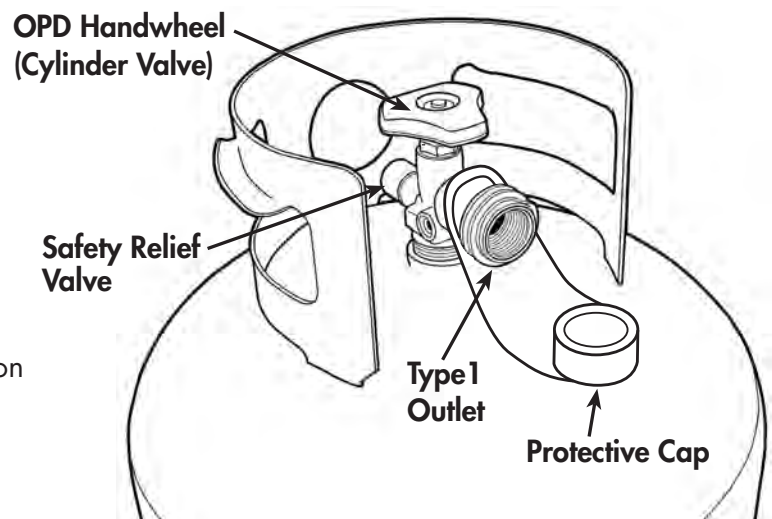

## ⚠️ WARNING ⚠️

- Turn off the cylinder valve when your cooker is not in use.
- Handle the LP gas cylinder with care.
- Always secure the LP gas cylinder in an upright position.
- Never connect an unregulated LP gas cylinder to your cooker.
- DO NOT expose LP gas cylinders to excessive heat or ignition sources.
- DO NOT store a spare LP gas cylinder near your cooker.
- Allow only qualified LP gas dealers to fill or repair your LP gas cylinder
- DO NOT allow the LP gas cylinder to be filled beyond 80% capacity.
- Read and follow all warnings/instructions that are on the cylinder and that accompany this product.

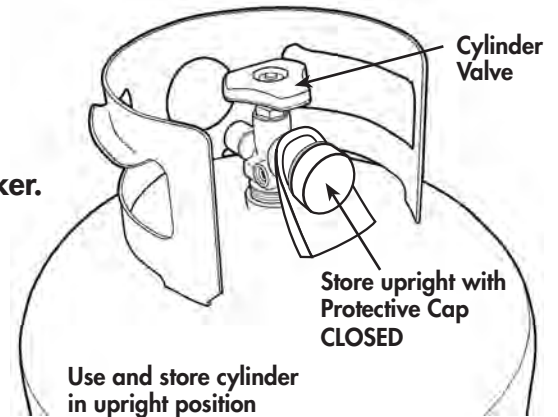

## ⚠️ DANGER ⚠️

- Never store spare LP gas cylinder near your cooker. This could cause excess pressure to be expelled through the vapor relief valve resulting in fire, explosion, or severe personal injury, including death.

**NOTE: PROPANE GAS IS HEAVIER THAN AIR AND WILL COLLECT IN LOW AREAS.  
PROPER VENTILATION IS EXTREMELY IMPORTANT**

- Keep the ventilation opening(s) of the LP gas cylinder enclosure free and clear from obstruction and debris.
- DO NOT insert any foreign objects into the valve outlet. Damage to the back-check could result. A damaged back-check can cause a leak, possibly resulting in explosion, fire, severe personal injury, bodily harm or death.

## ⚠️ WARNING ⚠️

### **FILLING THE LP GAS CYLINDER:**

- Allow only qualified LP gas dealers to properly fill or repair your LP gas cylinder.
- New tanks should be purged prior to filling; inform LP gas dealer if you are using a new tank.
- DO NOT allow the cylinder to be filled beyond 80% capacity. Over-filled tanks can create a dangerous condition. Over-filled tanks can build up pressure and cause the relief valve to expel propane gas vapors. The vapor is combustible and if it comes in contact with a spark source or flame; an explosion causing severe burns, bodily harm, or death could occur.
- Always use a protective cylinder cap when cooker is not connected to cylinder.
- If you exchange a cylinder with a qualified exchange program, be sure the cylinder has a Type-1 valve and an over-filling prevention device (OPD).

# REGULATOR HOSE ASSEMBLY

Your cooker is equipped with a Type-1 connection device with the following features:

1. The system will not allow gas flow from the cylinder until a **positive connection** to the cylinder valve has been made.

**NOTE:** The cylinder valve must be turned off (clockwise) before any connection is made or removed.

2. A **flow limiting device**, when activated, restricts the flow of gas to 10 cubic feet per hour.

**NOTE:** the flow limiting device is a safety feature that can be activated when attempting to light cooker. If this occurs, refer to **Trouble Shooting** on pages 22-23 for proper remedy.

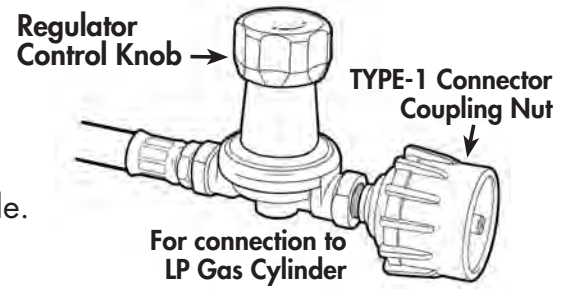

## ⚠ WARNING ⚠

The pressure regulator and hose assembly supplied with your gas cooker is designed to work with an LP gas supply cylinder.

- DO NOT attempt to connect it to any other fuel supply source such as a natural gas line.
- DO NOT use any other pressure regulator/hose assembly than the one supplied with your cooker.
- DO NOT attempt to adjust or repair the regulator. A replacement regulator can be supplied by contacting Barbour International, Inc. at 1-800-864-6194. The regulator is designed to operate at a maximum output pressure of 30 psi (pounds per square inch).

## ⚠ WARNING ⚠

- Never use your cooker without leak testing all gas connections, regulator hose assembly and weld seams on propane tank. See the section on "Gas Leak Testing" in this manual for proper procedures.

## CONNECTING REGULATOR HOSE ASSEMBLY TO BURNER

The Regulator Hose Assembly is a pre-assembled unit. Do not take apart. Simply connect the regulator hose assembly to the LP gas cylinder and to the cooker. An adjustable wrench is needed when attaching the hose to the burner.

Visually inspect the regulator hose assembly prior to each use. If there is evidence of abrasion, wear, cuts or leaks, the hose must be replaced prior to the appliance being put into operation.

Call 1-800-864-6194 for replacement Model #M5HPR-30. M-F 8am - 5pm CST.

Attach hose connector to the burner as shown below.

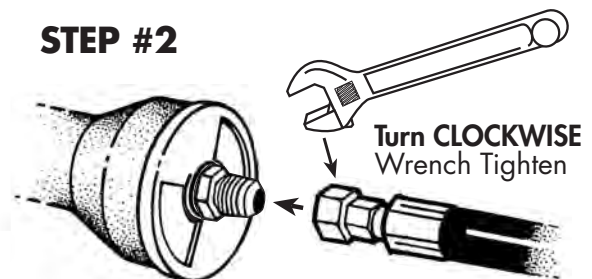
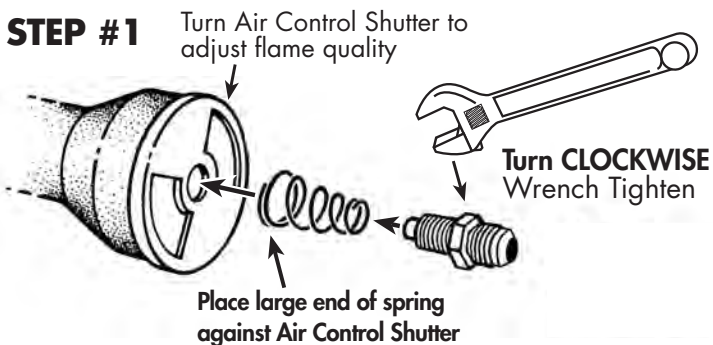

**IMPORTANT:** Must be able to turn Air Control Shutter... **DO NOT** over tighten!

## ⚠️ WARNING ⚠️

Insure the cylinder valve is **CLOSED** (valve turned clockwise) prior to connecting the LP gas cylinder to your cooker. Turn the regulator control knob counter-clockwise to properly close the regulator valve. Read and follow all instructions and warnings on the supply hose safety tags. Read and follow all warnings in this manual concerning the safe use of LP gas cylinders and the regulator hose assembly, before connecting cylinder to cooker. Read and follow all warnings on the LP gas cylinder.

## CONNECTING REGULATOR HOSE ASSEMBLY TO LP GAS CYLINDER

1. Check that cylinder is upright and the valve is closed by turning the knob clockwise.
2. Remove the protective safety cap from the cylinder valve and the Type-1 Coupling Nut.
3. Insert the nipple of the large coupling nut into the valve outlet. Insure that the coupling nut is centered properly.
4. Turn the large coupling nut clockwise by hand and tighten to a full stop. Take care not to cross thread the coupling nut onto the cylinder valve. Do not over-tighten the control knob on the regulator valve. Do not use tools to tighten connection.

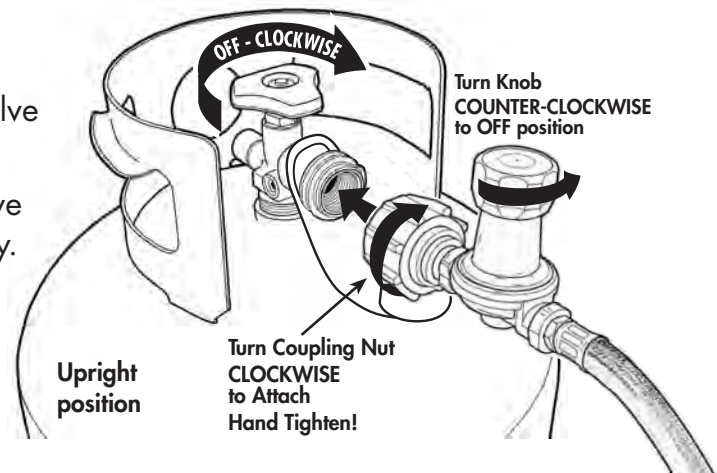

**NOTE:** If you are unable to make the connection, repeat steps 3 and 4.

5. Check that the hose does not contain kinks, does not come into contact with sharp edges, and does not contact surfaces that may become hot during use.
6. Leak check all fittings before lighting cooker. See section on "Gas Leak Test Instructions" on page 13.

## GAS LEAK TESTING

### ⚠️ DANGER ⚠️

#### LEAK TESTING

To prevent fire or explosion hazard:

- DO NOT smoke or permit ignition sources in the area while conducting a leak test.
- Perform test **OUTDOORS** only in a well ventilated area.
- Never perform a leak test with a match or open flame.
- Never perform a leak test while the cooker is in use or while cooker is still hot.

### ⚠️ WARNING ⚠️

#### WHEN TO PERFORM A LEAK TEST

- After assembling your cooker and before lighting for the first time, even if purchased fully assembled.
- Every time the LP gas cylinder is refilled or if any of the gas components are replaced.
- Any time your cooker has been moved.
- At least once per year or if your cooker has not been used for more than 60 days.

# GAS LEAK TEST INSTRUCTIONS

**Note:** The gas leak test must be performed in an area that has adequate lighting in order to see if bubbles are developing.

**DO NOT** use a flashlight to check for bubbles.

1. Create a mixture of 50% water and 50% liquid dishwashing soap.
2. Turn the gas cylinder valve to the OFF position (clockwise). Then turn regulator control knob to OFF position (counter-clockwise).
3. To turn ON the fuel supply, turn the cylinder valve knob one turn counter-clockwise. Gas will flow through and stop at the regulator.
4. Using a clean brush, apply the soap water mixture to the following:

- A** Cylinder Valve to Cylinder
- B** Connection Nut to Cylinder Valve
- C** Back side of Connection Nut to Brass Nipple
- D** Control Knob on Regulator
- E** Regulator connection to Gas Supply Hose
- F** LP Cylinder Welds
- G** Full length of Gas Supply Hose
- H** Gas Supply Hose connection to Burner Assembly

5. Check each place **A - F** for growing bubbles which indicates a leak.

6. Next, turn ON regulator control knob (clockwise) to permit gas to pass through the hose. Apply soap water mixture to full length of gas supply hose and connection to burner assembly. Check each place for growing bubbles, **G & H**, which indicates a leak.

7. Turn OFF gas supply valve (clockwise) on LP Gas Cylinder.

8. Turn regulator control knob to OFF position (counter-clockwise).

9. Tighten any leaking connections.

10. Repeat soap water mixture test until no leaks are detected.

**DO NOT use cooker if gas leaks cannot be stopped.**

**Call 1-800-864-6194 M-F 8am - 5pm CST for assistance, or contact a qualified appliance repair service.**

11. After you are certain there are no leaks, turn tank valve and regulator control knob to OFF position. Wait 5 minutes for any gas fumes to evacuate before lighting the burner.

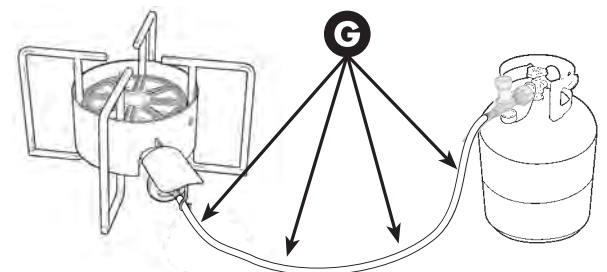
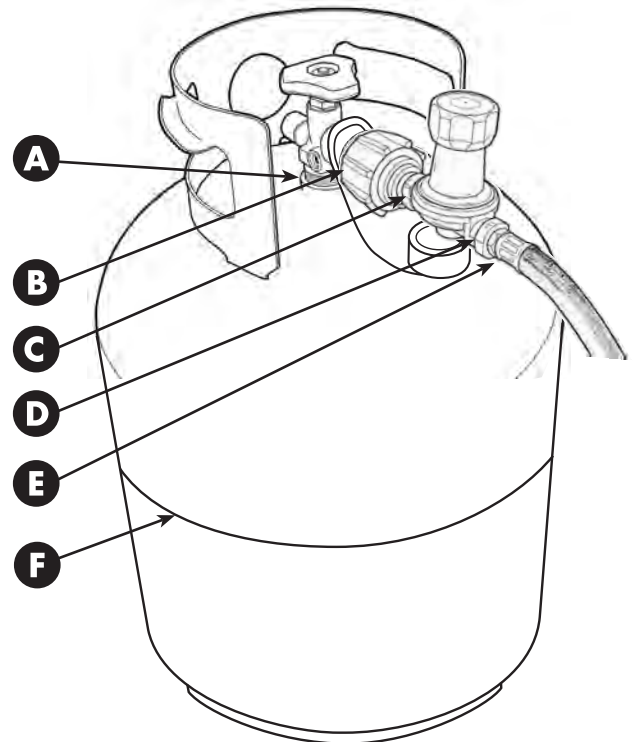

Watch for Bubbles

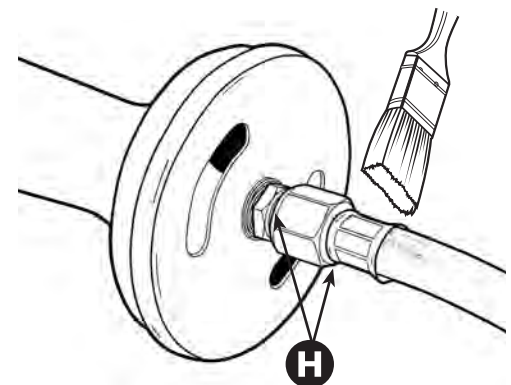

## ⚠ WARNING ⚠

If growing soap bubbles persist throughout any portion of the Gas Leak Test, terminate use immediately. For assistance, contact your propane dealer or Barbour International, Inc. at 1-800-864-6194.

## PRE-COOKING CHECK LIST

### ⚠ WARNING ⚠

**DO NOT** operate this cooker until you have read and understand **ALL** of the warnings and instructions in this manual. Property damage, bodily harm, severe burns and death could result from failure to follow these safety steps. These steps should be performed after the cooker has been assembled, stored, moved, cleaned, or repaired.

1. Insure that the cooker is properly assembled and connected to propane cylinder.
2. Position the cooker on level ground in a well ventilated location, a safe distance from combustible materials, buildings and overhangs. Propane cylinder should be positioned upwind from cooker so the heat of cooker does not reach cylinder. See section below on this page for **Positioning the Cooker**.
3. Inspect the gas supply hose for burns, chaffing kinks and proper routing before each use. Hose should be positioned at least 3 inches away from hot surfaces.
4. Leak check all gas connections on regulator hose assembly, LP cylinder valve and weld seams. See section on **Gas Leak Testing** on page 13.
5. Insure that all electrical supply cords are properly grounded and are kept away from this appliance, water and hot surfaces. **DO NOT** use external electrical sources with this appliance.
6. Determine proper amount of cooking liquid to use. See section for **Proper Amount of Cooking Liquid** on pages 17 - 18.
7. Follow Lighting Instructions. See section for **Lighting Instructions** on pages 15 - 16.
8. **Read, understand and follow all cooker operating instructions.**

## POSITIONING THE COOKER

1. Check wind direction.
2. Position cooker **DOWNWIND** from the nearest structure; no closer than 10-ft from nearest building or railing, keeping flames from any potential oil/grease fire away from nearest structure.
3. Position cooker **DOWNWIND** from the LP Gas Cylinder keeping a minimum distance of 20" apart so the heat of the cooker does not reach cylinder.
4. Position cooker on level ground in a well ventilated location, a safe distance from combustible materials, rails, buildings, overhangs or tree branches.

↑ **Make sure overhead is clear of combustible materials!** ↑

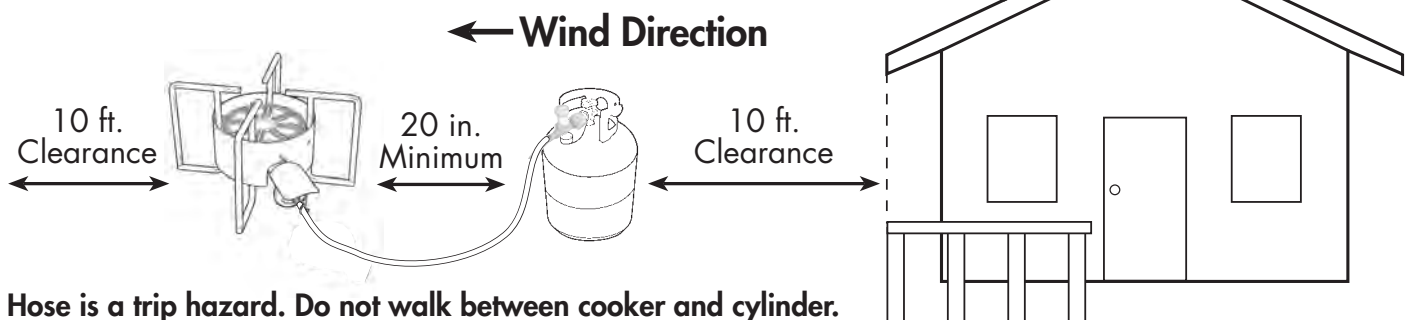

5. Check that gas supply hose does not contact surfaces that may become hot during use.

# LIGHTING INSTRUCTIONS

## ⚠ WARNING ⚠

**DO NOT** stand with head, body or arms over the cooker when lighting. Loose clothing and hair can catch fire.

Follow the instructions exactly. Read and follow all warnings and instructions in this manual before using your cooker.

1. Make sure the regulator control knob and cylinder valve are in the OFF positions.
2. Turn ON the fuel supply by S-L-O-W-L-Y rotating the cylinder valve counter-clockwise **one full turn**. **HINT: Turning the cylinder valve quickly causes a sudden rush of gas that sometimes activates the Gas Flow Limiting Device. To prevent this, always rotate cylinder valve S-L-O-W-L-Y.**
3. Place fire place match or long lighter over the burner, then S-L-O-W-L-Y turn regulator control knob clockwise until you hear gas HISSING to the burner. Then light the burner, keeping hands and face away from the top of the cooker. **After lighting, rotate cylinder valve to full open.**
4. Adjust air control shutter on burner for a blue flame. In direct sunlight, flame may appear clear.
5. Adjust the regulator control knob for desired flame height.

### BEFORE LIGHTING

Make sure LP Cylinder is OFF    Make sure Regulator is OFF

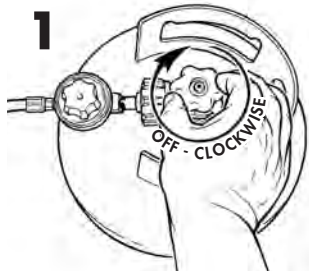

S-L-O-W-L-Y Turn  
LP Cylinder Valve One Full Turn

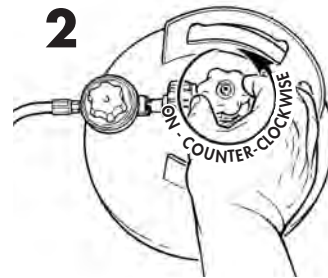

Gas will flow to and stop at closed regulator

### LIGHTING

Place Match over Burner

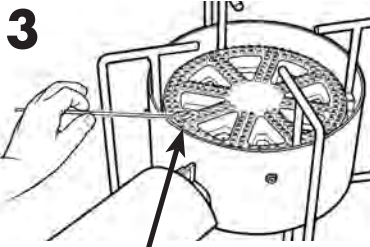

**LIGHT BURNER HERE!**

S-L-O-W-L-Y  
Turn Regulator Control Knob ON

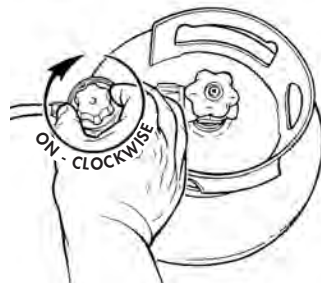

After lighting Burner, OPEN  
LP Cylinder Valve FULLY

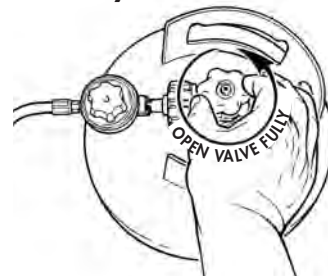

ADJUST Air Control Shutter  
for Blue Flame



ADJUST Regulator Control Knob  
for Flame Height

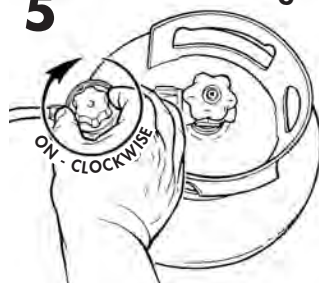

**NOTE:** The control knob (valve) on regulator hose assembly controls flame intensity only. It is not an ON/OFF valve. Practice rotating the regulator control knob to become familiar with flame adjustment.

### ⚠ WARNING ⚠

**DO NOT** light burner at air intake

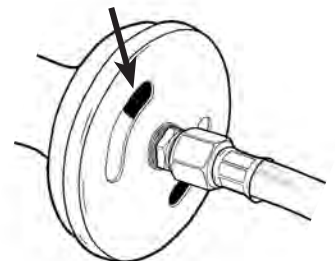

## BURNER FLAME CHECK

Adjust flame height using regulator control knob. Rotate air control shutter to achieve mostly blue flame. The air control shutter mounted on the front of burner helps to control the amount of air that mixes with the LP gas. A blue flame with little or no yellow flame indicates a proper air/gas mixture and provides the best heat. Adjust the air control shutter until the desired flame is achieved.

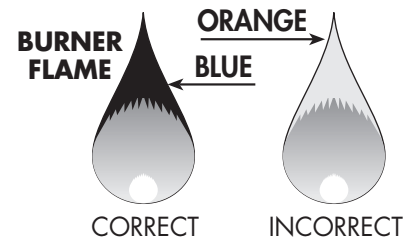

**NOTE:** Make sure the brass fitting on the hose is screwed onto the burner/air shutter and tightened securely. Do not over-tighten as the air shutter needs to move freely in order to adjust air intake. Check the regulator hose attachment for proper connection everytime propane tank is connected to cooker.

**HINT:** Before lighting, turn air control shutter on the burner to an almost closed position. This increases the gas portion of the air/gas mixture and makes the burner easier to light. After lighting, turn air control shutter to an open position to achieve a better flame.

When lighting for the first time, you will smell paint burning at the top of the cooker for a few minutes... This is normal.

If burner flame does NOT ignite immediately, or is accidentally extinguished, turn valve on LP Gas Cylinder clockwise to OFF. Then turn regulator control knob OFF counter-clockwise. Wait 5 minutes for gas to evacuate before re-lighting, then repeat steps 1-5 to re-light. Always use caution when re-lighting as cooker frame and cooking vessel will be hot.

If the burner does not light within the first few attempts, there is a problem with the gas supply. Turn off the gas at the cylinder and regulator. **DO NOT** attempt to operate the cooker until the problem is found and corrected. Refer to Troubleshooting on pages 21 - 22.

## HOW TO REIGNITE BURNER

Follow steps 1 through 5 on previous page, to reignite burner. Use caution when re-lighting the burner, as hot liquid from cooking vessel may have splattered and run down the sides of the unit creating a slick surface. Use caution not to bump the cooker or cooking vessel when re-lighting the burner.

## TURNING OFF THE COOKER

**NOTE:** Turn off LP gas cylinder valve first to prevent gas from being left in the regulator hose system under pressure.

1. Turn OFF the LP gas cylinder valve **clockwise** until it stops.
2. Turn regulator control knob to the OFF position, **counter-clockwise** until it stops.
3. To disconnect Regulator Hose Assembly, turn the large coupling nut **counter-clockwise** by hand.

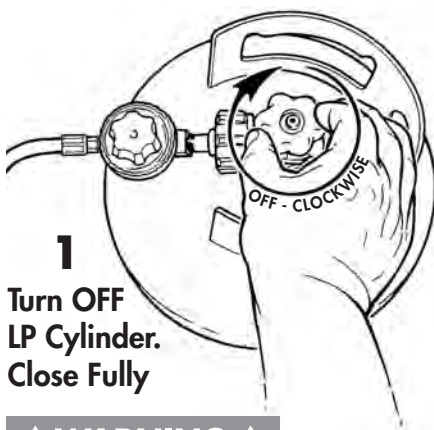

**1**  
Turn OFF  
LP Cylinder.  
Close Fully

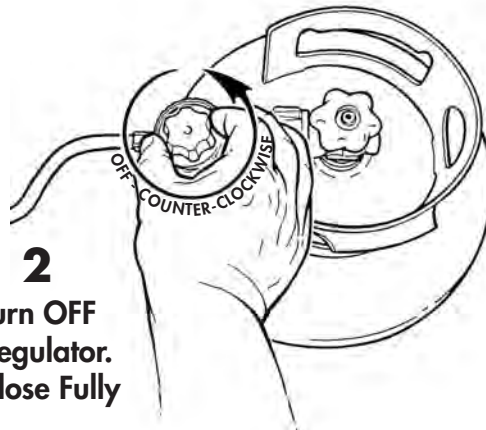

**2**  
Turn OFF  
Regulator.  
Close Fully

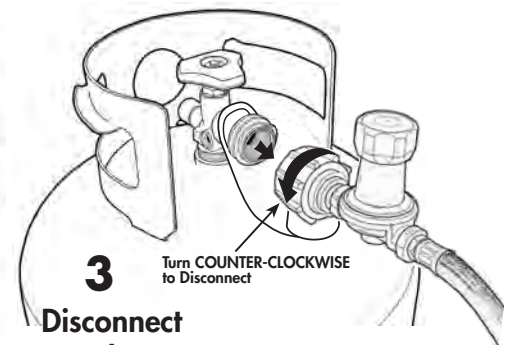

**3**  
Disconnect  
Regulator

**⚠ WARNING ⚠**

The LP gas cylinder valve should always be in the OFF or closed position when the cooker is not in use.

## OPERATING INSTRUCTIONS

### **⚠ WARNING ⚠**

Read, understand and follow all warnings and instructions contained in this manual. **DO NOT** skip any of the warnings and instructions contained in the preceding sections of this manual.

- **DO NOT** use a cooking vessel larger than 162-quart for boiling. **DO NOT** use a cooking vessel smaller than 14" diameter on this cooker.
- **DO NOT** use this cooker for frying with oil/grease.
- Determine what size cooking vessel to use and Proper Amount of Liquid for Cooking.
- Make sure cooker is positioned at least 10-ft from all combustible materials including building overhangs and tree branches. Follow positioning instructions on page 14.
- Check for gas leaks. Follow Gas Leak Testing Instructions on pages 12-13.
- Follow Lighting and Re-lighting Instructions on pages 15-16.
- Remain attended to the cooker at all times during heat up, cooking and cool-down period.
- Use extreme care when lowering food and utensils into and removing from hot liquid.
- When cooking is completed, turn off gas to the cooker. Follow Disconnecting Instructions in this manual.
- Follow General Maintenance and Storage Instructions of page 23.

## HOW TO DETERMINE PROPER AMOUNT OF LIQUID FOR COOKING

(For use with cooking vessels that have and do not have Maximum Fill Line)

**Do not use a cooking vessel larger than 162-quart for boiling. Do not use a cooking vessel smaller than 14" diameter on this cooker.**

### **⚠ WARNING ⚠**

If too much water is inside the cooking vessel, it is possible for spillovers to occur when adding a basket filled with food product, or during a rolling boil. Spillover of hot liquids can cause severe burns and property damage. Carefully read and follow these instructions.

### **BOILING WATER LEVEL DETERMINATION:**

1. Place the food product in the strainer basket.
2. Place the food product and strainer basket into the empty vessel.
3. Add water into the vessel until the food product is completely submerged. There must be a minimum of 3 inches between the water level and top of the vessel.
4. Remove the food product from the vessel. The remaining water level indicates the amount needed to cook the food product. Typically, the amount of water needed for boiling is one-third full or less.

## STEAMING WATER LEVEL DETERMINATION:

### **⚠ CAUTION ⚠**

Never allow all water to evaporate completely when steaming as the heat from this cooker can melt a hole in the cooking vessel.

Typically 2 to 3 inches of water is used for steaming food products. Use cooking vessel (stockpots) having perforated baskets that are elevated above the water level. Be certain your stockpot has a vented lid for steaming.

## BOILING INSTRUCTIONS

### **⚠ WARNING ⚠**

If too much water or oil is inside the cooking vessel, it is possible for spillovers to occur when adding a basket filled with food product, or during a rolling boil. Spillover of hot liquids can cause severe burns and property damage. Carefully read and follow these instructions.

1. Follow instructions to properly assemble and position the cooker. Perform gas leak test, and water level determination.
2. Add the determined amount of water into the cooking vessel.
3. Light the cooker by following Lighting Instructions in this manual.
4. Depending on the size of cooking vessel and volume of water used, heat up time can range from 15 to 45 minutes. Covering the cooking vessel with a lid will accelerate water heat up time to the boiling point.
5. Once water has achieved a rolling boil, reduce cooker flame as low as possible by turning regulator valve as directed.
6. Using an insulated mitt, carefully remove the lid.

### **⚠ CAUTION ⚠**

Open far side of the lid first so that steam and heat escape away from you.

7. Using an insulated mitt, carefully lower the food basket into the boiling water, then place lid back on the cooking vessel. **NOTE: Immersing the food basket will quickly reduce water temperature.**
8. Increase cooker flame to desired level by turning regulator control knob as directed. It will take several minutes for water temperature to increase and achieve a rolling boil.

### **⚠ CAUTION ⚠**

Once a rolling boil is achieved, reduce cooker flame to maintain the desired level. Lowering cooker flame reduces chance of a boil over during cooking.

## **FOLLOW 3-MINUTE : 15-MINUTE BOILING RULE**

Boiling time varies with type of food being cooked. Seafood generally has the shortest boiling time. For superior cooking results, follow these simple steps:

1. Heat water to rolling boil.
2. Reduce cooker flame and carefully lower food basket into boiling water and cover the pot.
3. Increase cooker flame and cook until a rolling boil is achieved.
4. Leaving pot covered, reduce cooker flame and allow rolling boil to continue for **3-minutes**.
5. After **3-minutes** have passed, **shut off gas to the cooker**. Leave the pot covered and allow to set another **15-minutes**.

**During this 15-minute period, the food will continue to cook and absorb seasoning without being over-cooked. Generally, the 3-minute : 15-minute rule results in shrimp and crawfish being perfectly cooked, seasoned and easy to peel.**

### **REMOVING BASKET FROM COOKING VESSEL:**

1. Shut off gas to the cooker.
2. Wearing an insulated mitt, carefully remove lid from pot.

## **⚠ CAUTION ⚠**

**Remember, lift the far side of lid first to protect you from escaping steam and heat.**

3. Wearing an insulated mitt, carefully and slowly lift basket from the cooking vessel.
4. Hold the basket above the cooking vessel to allow hot water to drain.

## **⚠ WARNING ⚠**

- Use extreme caution when lifting a food basket from boiling water.
- Be certain cooker is turned off.
- In addition to an insulated mitt, wear shoes, long pants and shirt sleeves to prevent burns from splashing hot water.
- Food baskets in stockpots from 60-qt to 162-qt are very heavy and should be a 2-person operation.
- A 2-person basket Lift Assist Bar is recommended for cooking vessels of 100-qt to 162-qt size.

5. Carefully pour out the food product and... enjoy!

# STEAMING INSTRUCTIONS

Typically 2 to 3 inches of water is used for steaming food products. Use cooking vessel (stockpot) having perforated basket that is **elevated** above the water level. Be certain your stockpot has a **vented lid** for steaming.

## **WARNING**

- **Use an insulated mitt when lifting stockpot lid when steaming. Steam escaping through the lid vent under pressure is invisible and can cause severe burns. Use extreme caution when removing stockpot lid when steaming or boiling.**
- **Do not allow water to evaporate completely during steaming. The bottom of aluminum stockpots will quickly warp and melt if all water evaporates; even under a low flame. If steaming for a long period of time you will need to occasionally add water to the stockpot.**

1. Follow instructions to properly assemble and position the cooker. Perform gas leak test, and water level determination.
2. Arrange food in the perforated basket.
3. Heat up time for 2 to 3 inches of water will be very fast.
4. Once boiling is achieved, reduce cooker flame by turning regulator valve as directed.
5. Using an insulated mitt, carefully lower food basket into the cooking vessel, then cover with lid. (Be certain food is not touching the water.)
6. Leave the cooker flame set low during cooking to maintain a steady boil.  
**Hint: Cooked seafood turns from translucent to opaque when done.**
7. When steaming is done, turn off gas to the cooker. Wearing an insulated mitt, carefully lift the lid and remove food basket from the cooking vessel.

## TROUBLE SHOOTING TIPS

Sometimes the burner does not light or has a only a meager match flame. Other times, the flame blows out, burns yellow, or there is a flame inside the burner tube. These symptoms are common and easy to remedy. **The following Trouble Shooting Tips cover most questions and problems associated with outdoor gas cooker appliances. Save this manual for future reference.**

### 1. SYMPTOM:

Burner lights but the flame remains very small and will not increase for heat-up and cooking.

### CAUSE:

Both LP cylinder and regulator couplings contain an **EXCESS FLOW** safety device that shuts off 90 percent of gas flow should the hose be cut or severed. **Sometimes this safety device can be activated when lighting the burner.** Opening the cylinder valve **too quickly** can create the rapid flow of gas that activates the excess flow safety device.

### POSSIBLE SOLUTION:

Repeat **Lighting Instructions** steps 1 through 5 on on page 15. Follow lighting instructions and be certain to S-L-O-W-L-Y open cylinder valve **one full turn**, then S-L-O-W-L-Y open regulator valve when lighting.

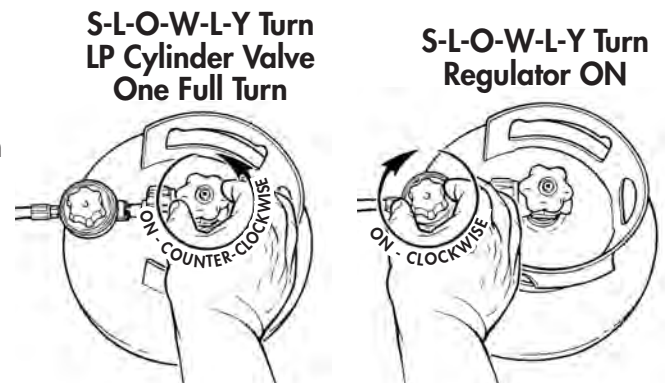

### 2. SYMPTOM:

Burner will not light.

### CAUSE:

Blockage in burner from insects, spider webs, dirt, dobees or wasp nests and debris. This is a frequent problem in the Deep South.

### POSSIBLE SOLUTION:

Clean burner to remove spiders, insect nests and other debris.

1. Turn gas OFF at LP cylinder valve and at regulator control knob.
2. Disconnect regulator hose assembly from burner and remove air control shutter.

**NOTE: Wear eye protection when cleaning burner.**

3. Use a narrow bottle brush or a stiff wire bent into a small hook to run through the burner tube. Push the bottle brush or bent wire back and forth through the burner tube.
4. Wire brush entire surface of burner to remove food residue and dirt.
5. Re-assemble air shutter and brass orifice connector on burner. Re-connect hose to burner.
6. If burner is damaged, obtain a replacement burner.

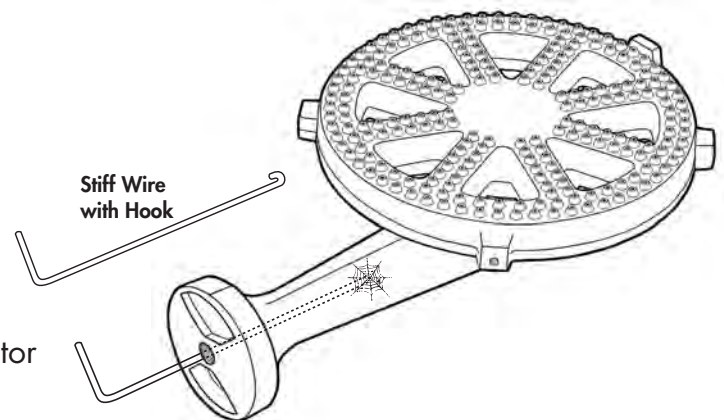

**Model BG14**

# TROUBLE SHOOTING GUIDE

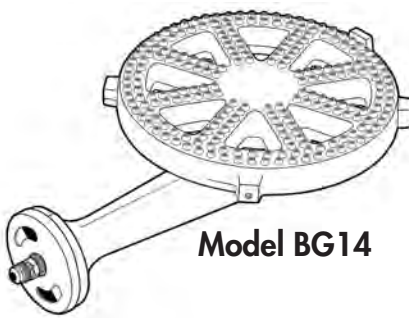
SYMPTOM	CAUSE	POSSIBLE SOLUTION
<b>Burner lights but the flame remains very small</b> Repeated from page 21	Rapid gas flow from propane tank activates EXCESS FLOW safety device	Repeat lighting instructions and be certain to S-L-O-W-L-Y open cylinder valve one full turn, then S-L-O-W-L-Y open regulator valve to light burner
<b>Burner will not light</b> Repeated from page 21	Blockage in burner from spider webs, insects, dirt dobbers and debris	Disconnect hose from burner. Clean and check burner for spiders, insect nests and debris
<b>Burner will not light and burner tube is clean</b>	Too much air and not enough gas	Turn air shutter to almost closed position, then re-light the burner
	Not enough gas flow from propane tank	Open propane tank valve all the way
	Low gas level in propane tank, or tank is empty	Check gas level in propane tank, re-fill or exchange tank
	Faulty burner	Contact <b>1-800-864-6194; Model BG14</b>
<b>Yellow, sooty, irregular flame</b>	Air shutter not adjusted correctly causing too much gas in mixture	Adjust air shutter on the burner until flame is blue - See page 16
	Blockage in burner	Clean and check burner for spiders, insect nests and debris
<b>Hissing or gurgling sounds coming through regulator hose assembly from tank to burner</b> <div style="background-color: #cccccc; padding: 2px; display: inline-block;"><b>⚠ WARNING ⚠</b></div> <b>Do not use this appliance if gas leaks cannot be stopped and corrected.</b>	Water in burner	Check burner for moisture, make sure burner is dry
	Damaged hose	Perform soapy water test to check for cracks in hose. See pages 12-13; <b>Model M5HPR30</b>
	Gas leak	Perform soapy water test to check all connections - See pages 12-13
<b>Flame has gone out</b>  <p style="text-align: center;"><b>Model BG14</b></p>	Low gas level in propane tank, or tank is empty	Check gas level in propane tank
	Too much wind	Check wind direction and set cooker away from windy areas
	Blockage in burner	Clean and check burner for spiders, insect nests and debris
	Water in burner	Check burner for moisture, make sure burner is dry
	Faulty burner	Contact <b>1-800-864-6194; Model BG14</b>

## GENERAL MAINTENANCE & STORAGE

Intense heat from the cooker will burn away paint from parts of the frame and windscreen flashing. This is normal and will cause a slight 'odor' for a few minutes during the initial use. The exposed steel will rust. Occasional care must be taken to prolong the life of your cooker.

1. Store cooker in a dry place. Do not store outside exposed to weather. Storage of a gas cooker appliance indoors is permissible only if the cylinder is disconnected. If storing cooker indoors, detach and leave LP cylinder outdoors. LP cylinders must be stored outdoors out of the reach of children and must NOT be stored in a building, garage or any other enclosed area.
2. Occasionally spray paint on affected areas of cooker frame after it has cooled.
3. Spray WD-40 on the burner grid after it has cooled.

### **⚠ DANGER ⚠**

**Spray paint and other aerosols contain flammable PETROLEUM DISTILLATES under pressure. Flame from burner or heat from cooker may cause spray can to burst violently resulting in death, serious burns and bodily harm. Perform all touch up maintenance to cool dry cooker frame and burner, below 115°F (45°C).**

4. For long term storage, cover the cast iron burner and regulator hose assembly in a plastic bag.
5. Spiders and small insects have been known to spin webs inside the burner tube. Obstructions in the burner tube interfere with the flow and mixture of air and gas through the burner. A clogged burner tube may result in a fire beneath the appliance. If this happens, remove the burner from the frame and clean the burner tube with a stiff, bent wire. Inspect and clean inside the top burner ports as well.
6. Turn air control shutter to closed position after each use to reduce chance of insect intrusion.
7. Do not tamper with or attempt repairs on the burner, frame, valves or LP cylinder. Allow only qualified LP gas dealers to make repairs. For replacement parts call Barbour International, Inc. at **1-800-864-6194**.
8. Always close LP cylinder valve first after use. Always use and store LP cylinder in an upright position. Never store or transport LP cylinders in occupied enclosures.
9. Check and tighten any loose hardware before each use.
10. Never store cooking liquids in aluminum cooking pots. Salt and seasoning will form pit holes in the bottom of the pot.

### **⚠ WARNING ⚠**

**Discard any aluminum cooking vessel should cooking oil leak through pit holes. Leaking oil will ignite and cause a fire.**

11. Inspect entire appliance including regulator hose assembly and burner assembly before each use. Replace any damaged or worn parts. Use only parts specified by Barbour International, Inc.

## CARE & USE INSTRUCTIONS FOR COOKWARE

### Polished Aluminum Pots

1. It is recommended to season aluminum pots before use. Pour small amount of vegetable oil inside and spread it with a paper towel until the entire bottom and sides are coated. Let it stand for 10 minutes. Wash out the interior of the pot, it will be ready to use. DO NOT apply to flame during any of this process.

## **⚠ CAUTION ⚠**

**Empty aluminum pots will melt if placed on cooker over an open flame.**

2. After cooking, let pans and lids cool gradually. Do not pour cold water into a hot pan. This can cause the bottom of the pan to warp, and it can cause oil/grease to splatter. Always wash the pans thoroughly in hot, soapy detergent after each use to remove all traces of food, salt, or grease particles that will burn causing stains when the pan is reheated.
3. Seasoning the pots will make cleaning easier. Scouring pads and aluminum cleaners are okay for the interior of the pots, but will scratch the exterior.
4. Polished aluminum pots will tarnish and discolor with normal use.  
**Our motto is: "The uglier the pot, the better it cooks!"** Occasional use of "Cream of Tartar" will bring back some of the luster. However, aluminum pots will tarnish and become dull with normal use.
5. Boiling with large quantities of salt is very corrosive and can cause **pits** in the pot and basket. To reduce the chance of this occurring, do not allow salt water or seasoned oil/grease to remain in the pot for a long period of time after the pot has cooled. The basket and pot should be thoroughly cleaned after each use. DO NOT store cooking oil inside the pots. Salt and seasonings will settle and can cause pits to form at the bottom of the pot.

### Stainless Steel Cookware

1. Before using for the first time, wash in hot soapy water. Dry immediately to prevent water spots. To prevent scratches, avoid using sharp utensils when cooking.
2. Discoloration of stainless steel cookware will result if the pieces are allowed to overheat excessively. For hard-to-clean stains or discoloration of the stainless steel, use a nonabrasive stainless steel cleaner. Follow the directions on the container using a clean, damp sponge or cloth. Do Not scrub finish with a soap-filled steel wool pad or harsh abrasive cleanser as scratching will occur.

### Cast Iron Cookware Seasoning Instructions

Seasoning prevents rust & keeps food from sticking.

1. Wash cast iron cookware in warm soapy water to remove the Paraffin wax coating.
2. Rinse and dry thoroughly.
3. Coat the entire surface of the cookware with solid vegetable shortening. Place in 300°F oven for one hour. **Hint:** Season the cookware outside in a gas grill keeping smoke and vapors away from the house.
4. Remove from oven or gas grill, pour out excess grease and wipe with a paper towel. Properly seasoned cast iron cookware will turn black after repeated use. This is normal.

# GRILLING PRODUCTS BY BAYOU CLASSIC®

## 100% NATURAL HARDWOOD CHARCOAL

### HIGH DENSITY NO SCRAP LUMBER FILLERS

- Burns Hotter, Last Longer
- Produces a Clean Burn with Less Ash



**500-408**  
8-LB. LUMP CHARCOAL



**500-418**  
18-LB. LUMP CHARCOAL

- 100% Natural Briquets contains same hardwood as
- Bayou™ Lump Charcoal Briquets bound together with Natural Corn Starch
- Lights Faster, Consistent Burn, Long Lasting

**NO CHEMICAL ADDITIVES  
NO LIMESTONE FILLERS**



**500-416**  
16-LB. CHARCOAL BRIQUETS



**500-724**  
24" BARREL GRILL



**500-736**  
36" SMOKER GRILL  
with FIREBOX



**500-746**  
48" VERTICAL SMOKER  
with 36" GRILL  
and FIREBOX



**500-515**  
CERAMIC CYPRESS® GRILL



**500-410**  
FOLD & GO  
CHARCOAL GRILL



**500-511**  
CHARCOAL STARTER



**0770-PDQ**  
STAINLESS STEEL  
LEG & WING RACK



**0880-CS**  
STAINLESS STEEL  
BEERCAN CHICKEN RACK



**1040-CS**  
STAINLESS STEEL  
GRILL TOOL

# OTHER PRODUCTS BY BAYOU CLASSIC®



**Stainless Steel and Aluminum Stockpots**  
24-Qt. - 162-Qt.



**Stainless Steel Stockpots with Spigot**  
36-Qt. & 44-Qt.



**Stainless Steel 6-PC. Brew Kettle Set**  
8, 10 & 16-Gallon



**5020 or 5025**  
5" or 12" Stainless Steel Thermometer



**Cast Iron Cookware**  
Dutch Ovens, Skillets, Griddles, and more



**M5HPR30**  
High Pressure LPG Stainless Braided Hose

30 PSI



**SQ14**  
Outdoor Patio Stove



**SP2**  
Double Jet Cooker with Hose Guard



**SP10**  
High Pressure Cooker



**DB375**  
Dual Burner Outdoor Patio Stove

**Jambalaya Kits**  
4-Gal. to 30 Gal.



**CHECK OUT OUR WEBSITE!**

**[www.thebayou.com](http://www.thebayou.com)**

For Questions and Information call us at: **1-800-864-6194**  
Monday - Friday 8:00am - 5:00pm CST

**Barbour International, Inc. • 101 Cypress Way • Brandon, MS 39042**