

This Owner's Manual is provided and hosted by [Appliance Factory Parts](http://www.appliancefactoryparts.com).



# Bayou Classic SP31 Owner's Manual

[Shop genuine replacement parts for Bayou Classic  
SP31](#)



[Find Your Bayou Classic Wood or Gas Stove Parts - Select From 25 Models](#)

----- Manual continues below -----

# BAYOU CLASSIC®



**READ MANUAL  
BEFORE USE**

MODEL  
#SP31/SS31

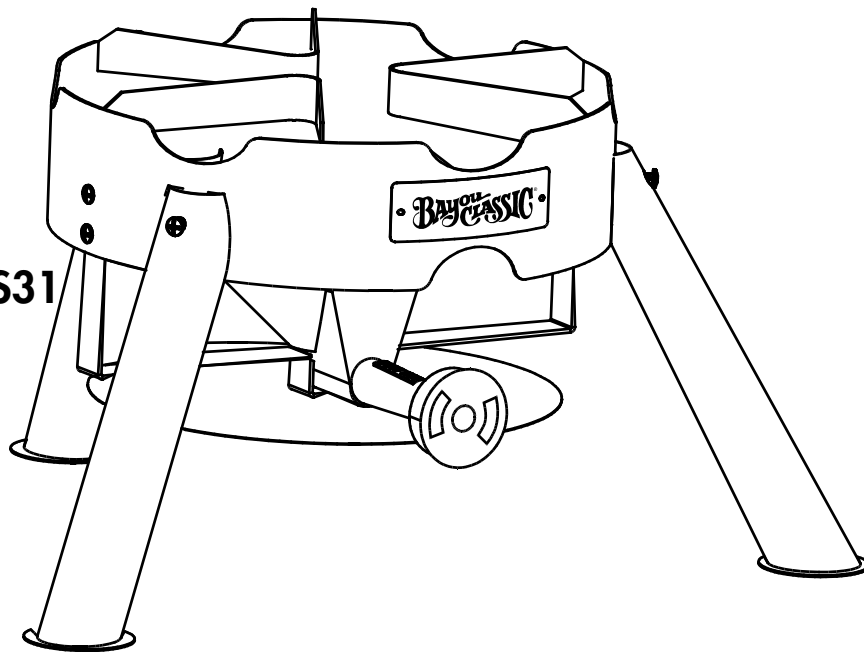

## LP GAS COOKER

# OWNER'S MANUAL

**SAFETY ALERTS, ASSEMBLY & OPERATING INSTRUCTIONS  
GENERAL MAINTENANCE & STORAGE**

This manual is for Barbour International "Bayou Classic" products only. If you are using another manufacturer's product, refer to the manual supplied with that product.

### **KEEP THIS MANUAL FOR FUTURE REFERENCE**

This Instruction Manual contains important information necessary for the proper assembly and safe use of this appliance. You must carefully read and follow all warnings and instructions in this manual before assembling and using this appliance.

### **NOT FOR COMMERCIAL USE**

For Questions and Information call us at:  
**1-800-864-6194** • Monday - Friday 7:30am - 4:30pm CST

Barbour International, Inc. • 101 Cypress Way • Brandon, MS 39042 • [www.thebayou.com](http://www.thebayou.com)

# SAFETY SYMBOLS

The symbols and boxes shown below explain what each heading means. Read and follow all of the safety warnings and instructions contained in this manual and on the cooker.

 **THE PURPOSE OF THIS SAFETY ALERT SYMBOL IS TO ATTRACT YOUR ATTENTION TO POSSIBLE HAZARDS AS YOU ASSEMBLE AND USE THIS PRODUCT.**

 **THE PURPOSE OF THIS SAFETY ALERT SYMBOL INDICATES FAILURE TO FOLLOW WARNINGS COULD RESULT IN FIRE OR EXPLOSION. PAY CLOSE ATTENTION TO THE INFORMATION WHICH FOLLOWS!**

 → Indicates an imminently hazardous situation which, if not avoided, will result in death or serious injury.

 → Hazard or unsafe practices which could result in severe property damages, personal injury, or death.

 → Hazard or unsafe practices which could result in minor personal injury, product, or property damages.

Carefully read and follow all **WARNINGS**, **SAFETY PRECAUTIONS** and **OPERATING INSTRUCTIONS** contained in this manual and on the cooker.

**DO NOT** skip any of the warnings and instructions! **SAVE THIS MANUAL FOR FUTURE REFERENCE.**

 **WARNING**

**FAILURE TO FOLLOW THESE INSTRUCTIONS COULD RESULT IN FIRE OR EXPLOSION WHICH COULD CAUSE PROPERTY DAMAGE, PERSONAL INJURY OR DEATH.**

- This cooker is a high pressure gas appliance for **OUTDOOR USE ONLY**.
- This cooker does not have automatic thermostat controls so must be attended and monitored at all times during use.
- Do not use a cooking vessel smaller than 12-inches diameter.
- This cooker is not intended to be used to fry turkeys!

 **DANGER**

**IF YOU SMELL GAS:**

1. Shut off gas to the appliance.
2. Extinguish any open flame.
3. Open lid.
4. If odor continues, keep away from the appliance and immediately call your gas supplier or your fire department.

 **WARNING**

- Do not store spare LP cylinder within 10 feet (3 m) of this appliance.
- Do not store or use gasoline or other flammable liquids or vapors within 25 feet (8 m) of this appliance.
- When cooking with oil/grease, do not allow the oil/grease to get hotter than 350°F (177°C).
- Do not leave oil/grease unattended.

## **DANGER**

- Never operate this appliance unattended. A sober, adult must attend and monitor this appliance at all times during use.
- Never operate this appliance within 10 feet (3.0 m) of any structure, combustible material or additional gas cylinders.
- Never allow oil or grease to get hotter than 350°F (177°C). If temperature exceeds 350°F (177°C), turn flame down to reduce heat. If temperature continues to rise, immediately turn burner or gas supply off. If oil/grease begins to smoke, regardless of temperature, immediately turn burner or gas supply off.
- Heated liquids remain at scalding temperatures long after the cooking process. Never touch the cooking appliance until liquids have cooled to 115°F (45°C) or less.

## **NOTE TO CONSUMER**

This LP Gas Cooker is a specialized high pressure gas appliance having greater heat output than traditional kitchen stoves. It is referred to as **cooker** and **appliance** in this manual and on warning tags. This cooker does not have automatic thermostat controls so must be attended and monitored at all times during use.

This LP Gas Cooker is for **OUTDOOR USE ONLY!**

As with any cooking appliance, care must be taken to follow all Safety Precautions and Instructions in order to achieve safe and satisfactory cooking results.

Restrict the use of this appliance to adults who can read, understand and follow the warnings and instructions in this manual, and on the cooker. Safety Alerts alone cannot eliminate the hazards that they signal. Strict compliance with these instructions, plus common sense operation, are primary accident prevention measures.

If having any doubts or concerns about your ability to use this product contact Bayou Classic®.

Should you still have concerns about operating this product, then do not use. Contact your dealer for return and refund. **Remember; Think Safety and Use Common Sense!**

## **DANGER**

### **IF OIL OR GREASE FIRE OCCURS**

**In the event of an oil/grease fire, do not attempt to extinguish with water. Immediately call your local Fire Department. A Type BC or ABC dry chemical fire extinguisher may in some cases contain the fire.**

**If a fire occurs INSIDE THE COOKING VESSEL follow these steps.**

- Turn off gas supply.
- Wearing a protective glove, cover the pot with a lid. DO NOT re-open lid as the oil/grease fire could re-ignite. Allow cooking vessel to cool down to 115°F (45°C) before opening lid.

**If a fire occurs OUTSIDE THE COOKING VESSEL follow these steps.**

- Turn off the gas supply if possible.
- Wearing a protective glove, cover the pot with a lid if possible.
- Call the local Fire Department if property damage is possible.
- Attempt to extinguish using a chemical fire extinguisher specified.
- Once fire is extinguished, DO NOT re-open lid as the oil/grease fire could re-ignite. Allow cooking vessel to cool down to 115°F (45°C) before opening lid.

# Safety Precautions & Warnings

Outdoor gas appliances do not have automatic thermostat controls so must be attended and monitored at all times during use.



**WARNING**

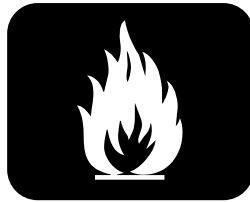

**FIRE HAZARD**



**READ MANUAL  
BEFORE USE**



**NEVER LEAVE  
UNATTENDED**



**OUTDOOR USE  
ONLY**



**INSURE PROPER  
POSITIONING**

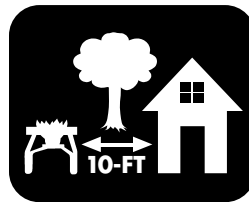

**KEEP AWAY FROM  
FLAMMABLE  
OBJECTS**

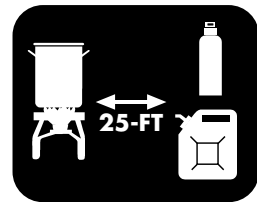

**KEEP FLAMMABLE  
MATERIALS AWAY**

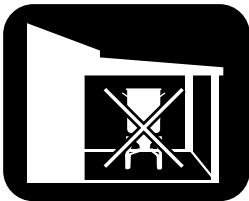

**NEVER USE UNDER  
FLAMMABLE  
OVERHANG**



**NEVER USE ON  
FLAMMABLE  
SURFACES**



**KEEP FIRE  
EXTINGUISHER  
NEARBY**

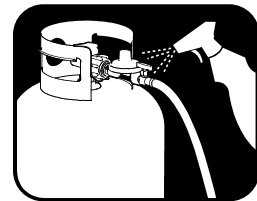

**ALWAYS PERFORM  
GAS LEAK TEST**



**TRIP HAZARD  
WATCH YOUR STEP**



**KEEP CHILDREN  
AND PETS AWAY  
FROM COOKER**



**NEVER LEAN  
OVER BURNER**

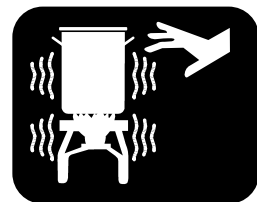

**HOT DURING AND  
AFTER USE!**

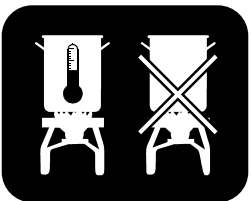

**USE THERMOMETER  
WHEN FRYING**

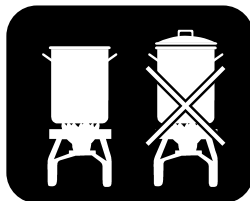

**NO LID ON POT  
WHEN FRYING**



**NO BARE FEET**



**DO NOT FRY  
TURKEYS**

**Failure to follow these instructions could result in fire or explosion which could cause property damage, personal injury or death!**

**Remember: Think Safety and Use Common Sense!**

## **WARNING**

### **GENERAL OPERATING**

- This appliance does not have automatic thermostat controls so must be attended and monitored at all times during use. Even when burner is set at a low flame, never leave the cooker unattended.
- This appliance has an open flame. In sunlight or other bright light, the flame may be almost invisible. Use extreme caution keeping hands, hair and clothing away from the cooker. Do not lean over the cooker when lighting burner. Long hair and loose clothing can catch fire during lighting and operation.
- This is an ATTENDED appliance, DO NOT leave this appliance unattended while heating oil, grease or water, cooking food or when hot after use. Heated liquid can remain at scalding temperatures long after cooking has ended.
- Keep children and pets away from the cooking area at all times. Carefully monitor all activity around cooker to avoid burns or other injuries.
- This appliance will be hot during and after use. Use insulated oven mitts or gloves for protection from hot surfaces or splatter from cooking liquids. Always wear closed toe shoes while cooking with this appliance.
- Use caution when walking or standing near cooker as splattered oil may have created a slick surface. Do not walk between cooker and propane tank as this creates a trip hazard. Tripping over the hose could overturn the cooker causing severe burns.
- Avoid bumping of or impact with the appliance to prevent spillage or splashing of hot cooking liquid which can cause severe burns.
- DO NOT move the appliance when in use. Allow cooking vessel to cool down to 115°F (45°C) before moving, cleaning or storing.
- Should the cooker flame go out during use, turn all gas valves off. Wait 5 minutes for gas to evacuate before re-lighting. See instructions in this manual for correct procedures.
- Never overfill a cooking vessel with oil, grease or water. Overfilled cooking vessels can boil over and cause a fire.
- After a period of storage or nonuse, check this appliance for gas leaks and burner obstructions before use. See instructions in this manual for correct procedures.
- Sober adult operation ONLY! The use of alcohol, prescription or nonprescription drugs may impair the ability to properly assemble or safely operate this appliance.
- DO NOT place an empty cooking vessel on the cooker while in operation as it could melt. Use caution when placing anything in a cooking vessel while the appliance is in operation.
- When cooking with oil/grease, have a Type BC or ABC fire extinguisher readily accessible.
- This appliance is not intended for and should never be used as a heater.
- Do not use this cooker for other than its intended purpose.
- Never use glassware, plastic, or ceramic cookware on this appliance.
- Only use replacement/accessory parts manufactured by Barbour International, Inc.
- Combustion by-products from the use of this product contain chemicals known to the State of California to cause cancer, birth defects, or other reproductive harm.
- This product contains a chemical(s) known to the State of California to cause cancer, birth defects or other reproductive harm.

## **WARNING**

### **COOKING WITH OIL OR GREASE**

- When cooking with oil or grease, a thermometer **MUST** be used for reasonable temperature reading. Follow instructions for **proper testing, installation and use of a thermometer in this manual**.
- Cooking oil pre-heat up to over-heat times can vary significantly with relatively small adjustments to regulator; variable wind, ambient temperature, altitude, starting oil temperature, and type of cooking oil used.
- Carefully monitor temperature of cooking oil with your thermometer and adjust regulator control valve as needed to prevent oil/grease from overheating.
- Never allow oil or grease to exceed 350°F (177°C). Oil or grease can ignite and catch fire at temperatures above 350°F (177°C).
- Due to varying heating and cooking times, check your thermometer every 3 minutes to ensure cooking oil does not exceed 350°F (177°C).
- High pressure cookers can typically heat 3 quarts of cooking oil/grease to 350°F (175°C) in 3 to 5 minutes.
- Even when burner is set at a low flame, never leave the cooker unattended. Cooking oil/grease will heat up quickly.
- **DO NOT** use a lid when pre-heating or cooking with oil. Using a lid when frying greatly increases the potential of over-heating the oil to ignition and fire.
- Smoking oil is an indication that the oil is too hot and may ignite. Regardless of thermometer reading, if the oil/grease starts to smoke, turn **OFF** fuel supply to the burner and **STOP COOKING IMMEDIATELY**. This indicates the thermometer is not working properly.
- Never overfill the cooking vessel with oil/grease or water. Follow instructions in this manual for establishing proper liquid levels for cooking.
- When frying with oil or grease, all food products **MUST** be completely thawed and towel dried to remove excess water. Failure to completely thaw and dry foods may cause oil or grease to overflow from cooking vessel. If ice is present on the food, it means the thawing process is not complete and may cause a boil over when placed into **HOT** oil causing a fire and severe burns.
- Never drop food or accessories into hot liquids. Wear protective gloves and **S-L-O-W-L-Y** lower food and accessories into cooking oil in order to prevent splashing or overflow. Be careful when removing food from oil. It is hot and could cause burns.
- In the event of rain, snow, hail, sleet or other form of precipitation while cooking with oil, cover the cooking vessel and immediately turn off the burner and gas supply. **DO NOT MOVE** cooker or cooking vessel.

## **WARNING**

### **PLACEMENT OF COOKER**

- **This cooker shall be used OUTDOORS ONLY.** **DO NOT** use in a building, home, garage, balcony, porch, tent or any other enclosed area. Gas cookers shall not be used on or under apartment, condominium balcony or deck. **DO NOT** install or use in or on recreational vehicles or boats.
- **DO NOT** operate this Gas Cooker closer than 10 feet (3m) from any combustible materials including walls or railing, or under overhead construction and tree branches as these materials could ignite should oil/grease fire occur.
- The cooker must be positioned on a level, stable, noncombustible surface such as brick, concrete or dirt. Do not position cooker on wood, asphalt or plastic which may burn, blister or melt.

## **⚠️ WARNING ⚠️**

### **PLACEMENT OF COOKER - CONTINUED**

- Keep the cooking area clear and free of any combustible material such as household chemicals, paint, gasoline and other flammable vapors and liquids. Do not store or use gasoline or other liquid/aerosols with flammable vapors within 25 feet (7.5m) of this cooker.
- Prior to lighting the burner, check wind direction for placement of cooker **DOWNWIND** from upright LP cylinder. The cooker must be **DOWNWIND** and at least 20" away from the LP cylinder to keep heat away from LP cylinder.
- Check that gas supply hose does not contact surfaces that may become hot during use.
- Installation of this product must conform with local codes or, in the absence of local codes, with the National Fuel Gas Code, ANSI Z223.1/NFPA 54, Storage and Handling of Liquefied Petroleum Gases, ANSI/NFPA 58, Natural Gas and Propane Installation Code, CSA B149.1, Propane Storage and Handling, CSA B149.2, or the Standard for Recreational Vehicles, ANSI A119.2/NFPA 1192 and the Recreational Vehicle Code, CSA z240 RV series.

↑ **Make sure overhead is clear of combustible materials!** ↑

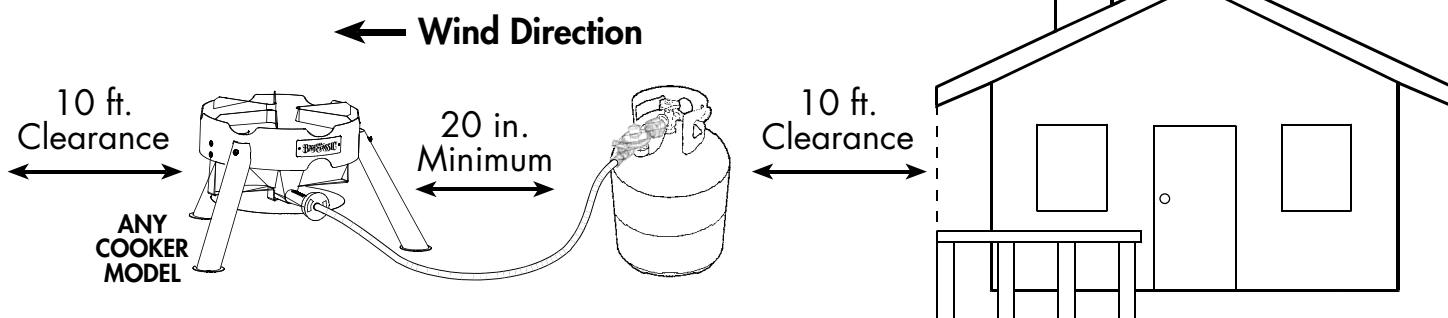

## **PRE-COOKING CHECK LIST AND OPERATING INSTRUCTIONS**

### **⚠️ WARNING ⚠️**

**DO NOT operate this cooker until you have read and understand ALL of the warnings and instructions in this manual. Property damage, bodily harm, severe burns and death could result from failure to follow these safety steps. These steps should be performed after the cooker has been assembled, stored, moved, cleaned, or repaired.**

1. Insure that the cooker is properly assembled and connected to propane cylinder.
2. Position the cooker on level ground in a well ventilated location, at least 10-ft from combustible materials, tree branches, buildings and overhangs. Propane cylinder should be positioned upwind from cooker so the heat of cooker does not reach cylinder.
3. Inspect the gas supply hose for burns, chaffing, kinks and proper routing before each use. Hose should be positioned at least 3 inches away from hot surfaces.
4. Leak check all gas connections on regulator hose assembly, LP cylinder valve and weld seams.
5. Remain attended to the cooker and when frying check the thermometer every 3 minutes.
6. Follow Lighting and Re-lighting instructions on pages 14 - 15.
7. Use extreme care when lowering food and utensils into and removing from hot oil or liquid.
8. When cooking is completed, turn off gas to the cooker. Follow Disconnecting Instructions in this manual.
9. Follow General Maintenance and Storage Instructions on page 18.

# ASSEMBLY INSTRUCTIONS

READ ALL SAFETY WARNINGS & ASSEMBLY INSTRUCTIONS CAREFULLY BEFORE ASSEMBLING OR OPERATING YOUR COOKER. Inspect contents in the box to ensure all parts are included and undamaged.

**FOR MISSING PARTS OR ASSISTANCE, PLEASE CALL 1-800-864-6194 M-F 7:30am - 4:30pm CST.**

Proof of purchase will be required.

## Model #SP31/SS31

### TOOLS REQUIRED:

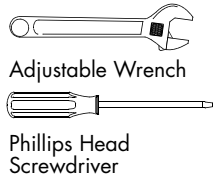

### PARTS INCLUDED:

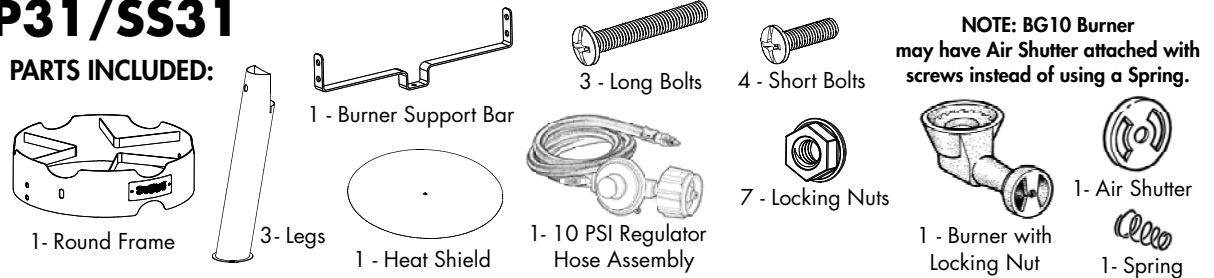

NOTE: BG10 Burner may have Air Shutter attached with screws instead of using a Spring.

## COOKER ASSEMBLY

1. Remove components from the box and packing. Turn base frame **upside down** as shown. Assemble cooker while in this upside down position.
2. **Mount Burner Support Bar** - Line up holes in support bar to the holes in the frame as shown. Attach bolts and nuts as shown. Wrench tighten.
3. **Attach Burner and Heat Shield to Support Bar**  
Remove locking nut from bottom of burner. Turn burner upside down as shown. Position long end of burner above large "U" in the frame. Position body of burner below support bar as shown. Line up burner bolt to center hole in support bar. Insert the bolt through the support bar. Place heat shield over bolt. Attach locking nut and wrench tighten.
4. **Attach Legs to Base Frame** - Slide legs on frame to match holes. Insert and hand tighten all bolts and nuts. **NOTE: You will wrench tighten leg bolts at a later stage.**
5. **Attach Hose to Burner** - Refer to Connecting Regulator Hose Assembly to Cooker on page 12. **NOTE: Do not over tighten brass hose connector to burner.** The air control shutter must be able to easily turn for adjustment of flame quality. If you have over tightened the brass hose connector to the burner and the shutter cannot turn, then unscrew the brass hose connector until the shutter can be easily turned... **Very Important!**
6. Return frame to upright position. Wrench tighten all leg bolts.

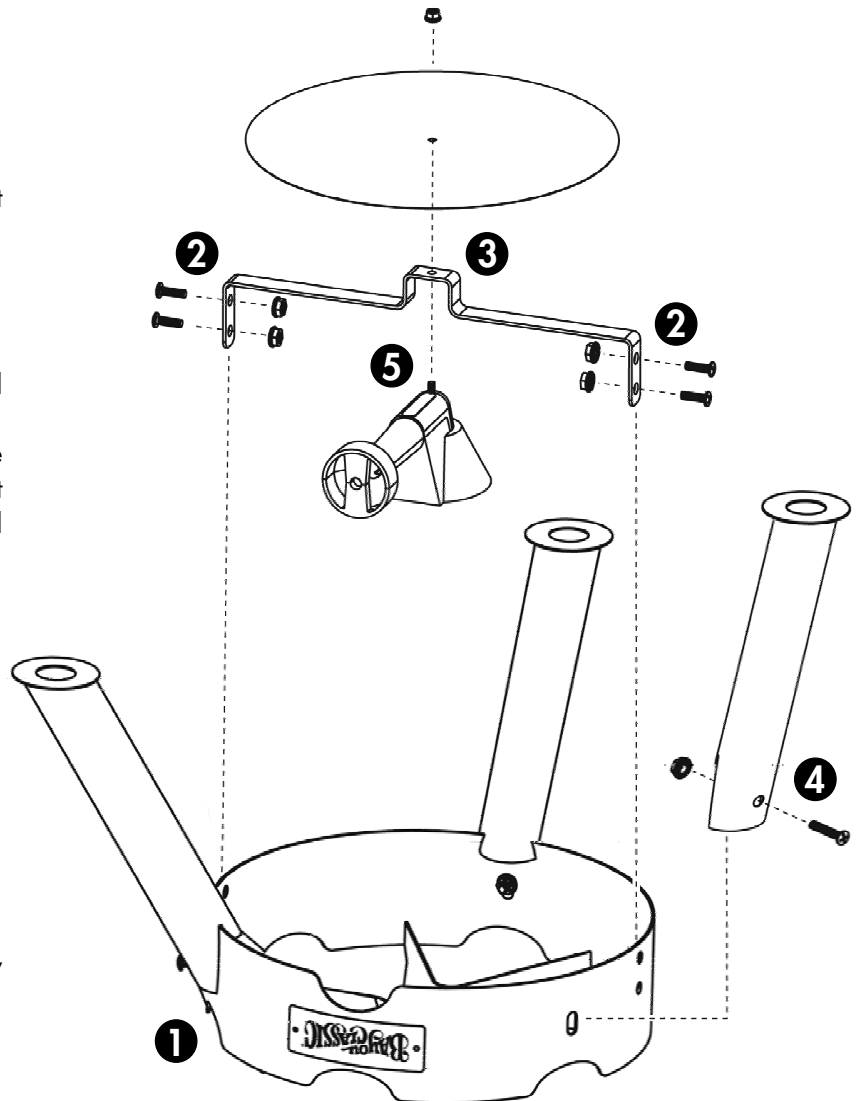

## **! DANGER !**

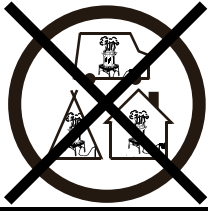

# **CARBON MONOXIDE HAZARD**

This appliance can produce carbon monoxide which has no odor.

Using it in an enclosed space can kill you.

Never use this appliance in an enclosed space such as a camper, tent, boat, car or home.

## **! WARNING !**

### **LP GAS CYLINDER**

- Use only a 20 pound LP Gas Cylinder or smaller with a protective collar.
- LP (propane) gas is colorless, tasteless, heavier than air, and is both flammable and explosive. Combustion of propane consumes oxygen and produces carbon monoxide, a poisonous gas. Therefore, never operate an outdoor cooker appliance inside a building or confined area where ventilation may be restricted. Make sure the LP cylinder and the cooker are placed in an open area. DO NOT obstruct the flow of combustion and ventilation air.
- Never use a gas cylinder if it shows signs of dents, gouges, bulges, fire damage, erosion, leakage, excessive rust, or other forms of visible external damage. The cylinder may be hazardous and should be checked by a qualified liquid propane supplier.
- Never attach a gas cylinder, move or alter fittings while cooker is hot or in operation.
- Do not attempt to disconnect the regulator hose assembly while cooker is in operation.
- When cooker use is complete, always turn the LP cylinder valve OFF first, then turn the regulator control valve OFF. Turning the cylinder OFF first allows remaining gas to flow out of the regulator hose assembly before the regulator control valve is turned OFF.
- DO NOT use external electrical sources with this appliance.
- Storage of this appliance indoors is permissible only if the cylinder is disconnected and removed from the appliance and left outdoors. Cylinders must be stored outdoors out of the reach of children and must not be stored in a building, garage or any other enclosed area.
- The installation of this appliance must conform with local codes or, in absence of local codes, with the National Fuel Gas Code, ANSI Z223.1/NFPA 54, Storage and Handling of Liquefied Petroleum Gases, ANSI/NFPA 58, Natural Gas and Propane Installation Code, CSA B149.1, Propane Storage and Handling, CSA B149.2, or the Standard for Recreational Vehicles, ANSI A119.2/NFPA 1192 and the Recreational Vehicle Code, CSA z240 RV Series.
- Refer to section about LP Gas Cylinder Information on pages 9 - 10 in this manual.

## **! DANGER !**



- A. DO NOT store a spare LP cylinder under or near a gas cooker appliance.
- B. Never fill the cylinder beyond 80% full.
- C. If the information in (A) and (B) are not followed exactly, a fire causing death or serious injury may occur.

## **LP GAS CYLINDER SPECIFICATIONS** NOT SUPPLIED WITH THIS COOKER

## **! WARNING !**

### **LP GAS CYLINDER**

The LP (Liquid Propane) gas cylinder specifically designed to be used with this cooker must have a 20 lb (9.1 kg) capacity incorporating a Type-1 cylinder valve and an over-filling protection device (OPD).

- DO NOT connect this cooker to an existing #510 POL cylinder valve with Left Hand Threads. The Type-1 valve can be identified with the large external threads on the valve outlet.
- DO NOT connect to a propane cylinder exceeding this capacity.
- DO NOT connect to a cylinder that uses any other type of valve connection device.

To check your local codes, see your local LP gas dealer or natural gas company. This cooker is not intended to be connected to a natural gas supply line.

When purchasing or exchanging a cylinder for your gas cooker, it must be constructed and marked in accordance with the specifications for LP gas cylinders by the U.S. Department of Transportation (DOT) or the National Standard of Canada, CAN/CSA-B339, Cylinders, Spheres and Tubes for the Transportation of Dangerous Goods as applicable with a listed over-filling device (OPD).

The cylinder must also be equipped with:

- A shut-off valve terminating in a Type-1 gas cylinder valve outlet.
- A Type-1 valve that prevents gas flow until a positive seal is obtained.
- An arrangement for vapor withdrawal.
- A collar to protect the cylinder shut-off valve.
- A safety relief device having direct communication with the vapor space of the cylinder.
- A listed Over-filling Prevention Device (OPD).
- A protective cap on cylinder Type-1 Outlet.

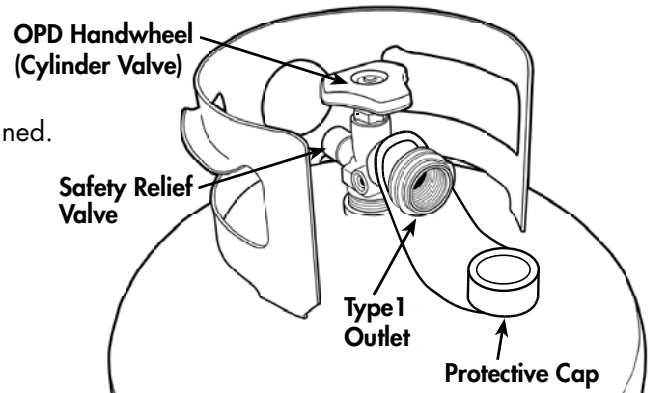

## ⚠️ WARNING 🔥

### FILLING THE LP GAS CYLINDER:

- Allow only qualified LP gas dealers to properly fill or repair your LP gas cylinder.
- New tanks should be purged prior to filling; inform LP gas dealer if you are using a new tank.
- DO NOT allow the cylinder to be filled beyond 80% capacity. Over-filled tanks can create a dangerous condition. Over-filled tanks can build up pressure and cause the relief valve to expel propane gas vapors. The vapor is combustible and if it comes in contact with a spark source or flame; an explosion causing severe burns, bodily harm, or death could occur.
- Always use a protective cylinder cap when cooker is not connected to cylinder.
- If you exchange a cylinder with a qualified exchange program, be sure the cylinder has a Type-1 valve and an over-filling prevention device (OPD).

## ⚠️ WARNING 🔥

- Turn off the cylinder valve when your cooker is not in use.
- Handle the LP gas cylinder with care.
- Always secure the LP gas cylinder in an upright position.
- Never connect an unregulated LP gas cylinder to your cooker.
- DO NOT expose LP gas cylinders to excessive heat or ignition sources.
- Read and follow all warnings/instructions that are on the cylinder and that accompany this product.
- Allow only qualified LP gas dealers to fill or repair your LP gas cylinder
- DO NOT allow the LP gas cylinder to be filled beyond 80% capacity.

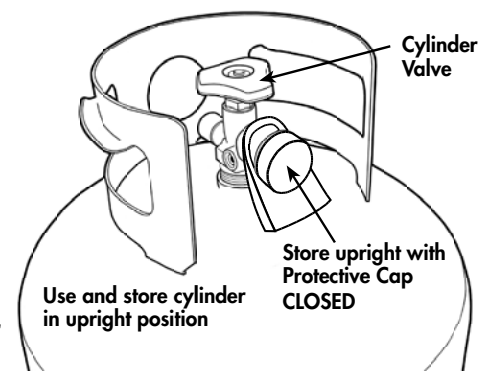

## ⚠️ DANGER 🔥

- Never store spare LP gas cylinder near your cooker. This could cause excess pressure to be expelled through the vapor relief valve resulting in fire, explosion, or severe personal injury, including death.  
**NOTE: PROPANE GAS IS HEAVIER THAN AIR AND WILL COLLECT IN LOW AREAS. PROPER VENTILATION IS EXTREMELY IMPORTANT**
- Keep the ventilation opening(s) of the LP gas cylinder enclosure free and clear from obstruction and debris.
- DO NOT insert any foreign objects into the valve outlet. Damage to the back-check could result. A damaged back-check can cause a leak, possibly resulting in explosion, fire, severe personal injury, bodily harm or death.

# REGULATOR HOSE ASSEMBLY

## ⚠️ WARNING 🔥

- The pressure regulator hose assembly supplied with this product must be used.
- Clean and inspect the hose before each use for any evidence of abrasion, wear, cuts or leaks. Hose must be replaced prior to use if any of these issues are found. Only use manufacturer recommended replacement assembly.
- Replace regulator hose assembly at least every two years.
- Keep the fuel supply hose away from any heated surface.
- Refer to instructions for connecting regulator hose assembly to LP gas cylinder and burner in this manual.
- The valve on regulator hose assembly controls the flame intensity only, it is not an ON/OFF valve.
- DO NOT attempt to connect to any other fuel supply source such as a natural gas line.
- DO NOT attempt to adjust or repair the regulator. A replacement can be supplied by contacting the manufacturer.
- DO NOT attempt to disassemble the regulator assembly.

## REGULATOR HOSE ASSEMBLY

- Use only the regulator hose assembly that is supplied with this appliance. Clean and inspect the hose before each use of the cooker. If there is evidence of abrasion, wear, cuts or leaks, the hose must be replaced prior to the cooker being put into operation. Replace regulator hose assembly at least every two years.

**This part can be purchased by contacting [www.thebayou.com](http://www.thebayou.com).**

- Refer to instructions for connecting regulator hose assembly to LP gas cylinder and burner in this manual.
- **The valve on regulator hose assembly controls flame intensity only. It is not an ON/OFF valve. Use LP Cylinder Valve to turn gas ON and OFF.**

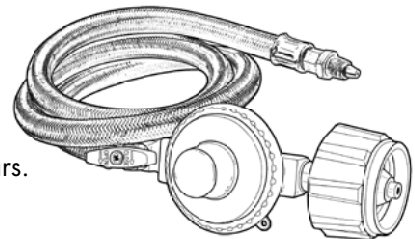

**Your cooker is equipped with a Type-1 connection device with the following features:**

1. The system will not allow gas flow from the cylinder until a **positive connection** to the cylinder valve has been made.  
**NOTE:** The cylinder valve must be turned off (clockwise) before any connection is made or removed.

2. A **GAS FLOW LIMITING DEVICE**, when activated, restricts the flow of gas to 10 cubic feet per hour.

**NOTE:** the flow limiting device is a safety feature that can be activated when attempting to light cooker. If this occurs, refer to **Trouble Shooting** on pages 16 - 17 for proper remedy.

3. After cooking is finished and cylinder valve is turned off; turn the Regulator Control Knob **counter-clockwise** to the **OFF** position. This will reduce possibility of activating the **Gas Flow Limiting Device** the next time you light the cooker.

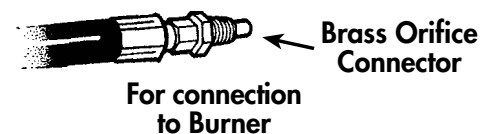
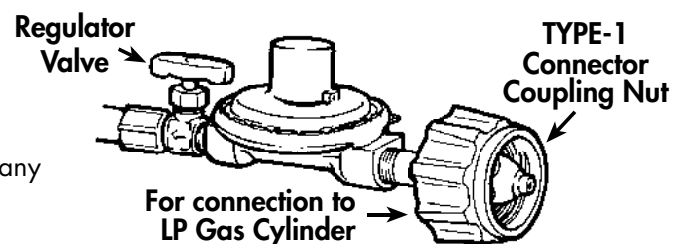

## ⚠️ WARNING 🔥

**Insure the cylinder valve is CLOSED prior to connecting the LP gas cylinder to your cooker. Turn the regulator control knob to properly close the regulator valve. Read and follow all instructions and warnings on the supply hose safety tags. Read and follow all warnings in this manual concerning the safe use of LP gas cylinders and the regulator hose assembly, before connecting cylinder to cooker. Read and follow all warnings on the LP gas cylinder.**

## CONNECTING REGULATOR HOSE ASSEMBLY TO LP GAS CYLINDER

1. Check that cylinder is upright and the valve is closed by turning the knob clockwise.
2. Remove the protective safety cap from the cylinder valve and the Type-1 Coupling Nut on the regulator
3. Insert the nipple of the large coupling nut into cylinder valve outlet. Insure that the coupling nut is centered properly.
4. Turn the large coupling nut clockwise by hand and tighten to a full stop. Take care not to cross thread the coupling nut onto the cylinder valve. Do not use tools to tighten connection.

**NOTE:** If you are unable to make the connection, repeat steps 3 and 4.

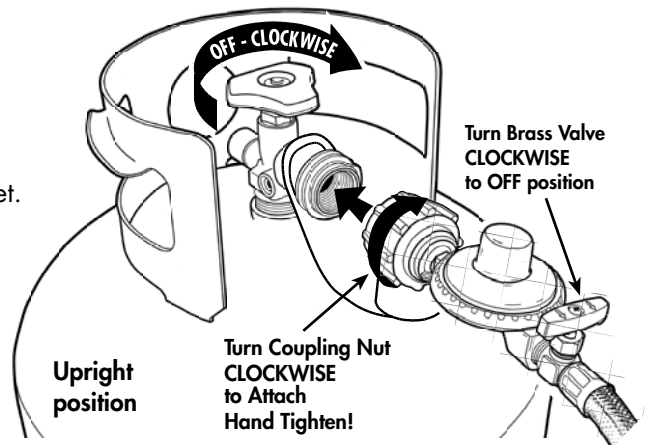

5. Check that the hose does not contain kinks, does not come into contact with sharp edges, and does not contact surfaces that may become hot during use.
6. Leak check all fittings before lighting cooker. See section on "Gas Leak Test Instructions" on page 13.

## CONNECTING REGULATOR HOSE ASSEMBLY TO COOKER

The Regulator Hose Assembly is a pre-assembled unit. Do not take apart. Simply connect the regulator hose assembly to the LP gas cylinder and to the cooker. An adjustable wrench is needed when attaching the hose to the burner. Visually inspect the regulator hose assembly prior to each use. If there is evidence of abrasion, wear, cuts or leaks, the hose must be replaced prior to the appliance being put into operation.

**Attach hose connector to the burner in one of two ways as shown below.**

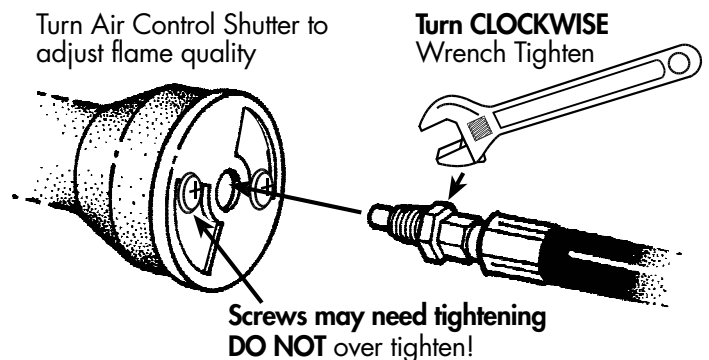

## GAS LEAK TEST

### **! WARNING !**

#### **WHEN TO PERFORM A LEAK TEST**

- After assembling your cooker and before lighting for the first time, even if purchased fully assembled.
- Every time the LP gas cylinder is refilled or if any of the gas components are replaced.
- Any time your cooker has been moved.
- At least once per year or if your cooker has not been used for more than 60 days.

### **! DANGER !**

#### **GAS LEAK TESTING**

To prevent fire or explosion hazard:

- DO NOT smoke or permit ignition sources in the area while conducting a leak test.
- Perform test OUTDOORS only in a well ventilated area.
- Never perform a leak test with a match or open flame.
- Never perform a leak test while the cooker is in use or while cooker is still hot.

# GAS LEAK TEST INSTRUCTIONS

**Note:** The gas leak test must be performed in an area that has adequate lighting in order to see if bubbles are developing. **DO NOT** use a flashlight to check for bubbles.

1. Create a mixture of 50% water and 50% liquid no-ammonia base dishwashing soap.
2. Turn the gas cylinder valve **I** to the OFF position (clockwise). Then turn regulator control knob **J** to OFF position (as indicated on knob).
3. To turn ON the fuel supply, turn the cylinder valve knob **I** one turn in the ON direction or OPEN direction. Gas will flow through and stop at the regulator.
4. Using a clean brush or spray bottle, apply the soap water mixture to the following:
  - A** Cylinder Valve to Cylinder
  - B** Connection Nut to Cylinder Valve
  - C** Back side of Connection Nut to Brass Nipple
  - D** Control Knob on Regulator
  - E** Regulator connection to Gas Supply Hose
  - F** LP Cylinder Welds
  - G** Full length of Gas Supply Hose
  - H** Gas Supply Hose connection to Burner Assembly
5. Check each place **A - F** for growing bubbles which indicates a leak.
6. Next, turn ON regulator control knob **J** to permit gas to pass through the hose. Check each place listed for growing bubbles, **G & H**, which indicates a leak. **NOTE: Do not allow gas to flow more than 5 - 10 seconds while checking for leaks, and then turn off gas supply at the cylinder. During this process, gas will be flowing out the burner into the air.**
7. Turn OFF gas cylinder valve **I** (clockwise) on LP Gas Cylinder.
8. Turn regulator control knob **J** to OFF position.
9. Tighten any leaking connections.
10. Repeat soap water mixture test until no leaks are detected. **DO NOT use cooker if gas leaks cannot be stopped.**
11. If no leaks are detected, leave the gas supply at cylinder valve and regulator turned off until you are ready to use product.
12. Wash off soapy residue with cold water and towel dry.
13. Wait 5 minutes to allow all gas to evacuate the area before lighting burner.

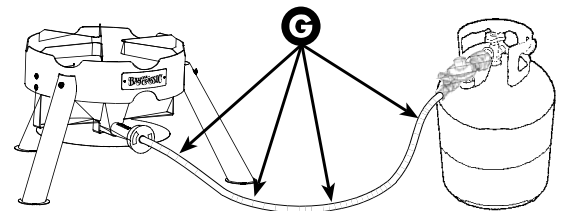
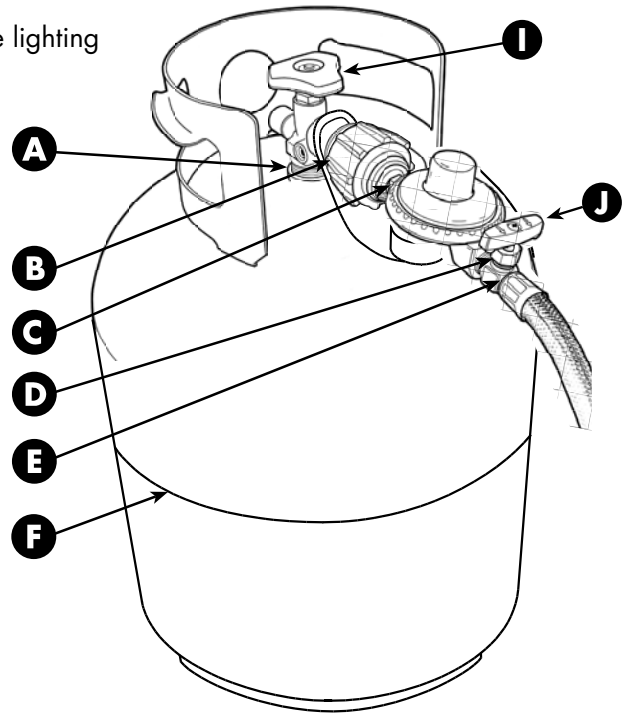

Watch for Bubbles

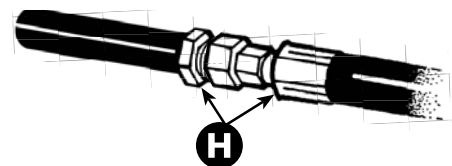
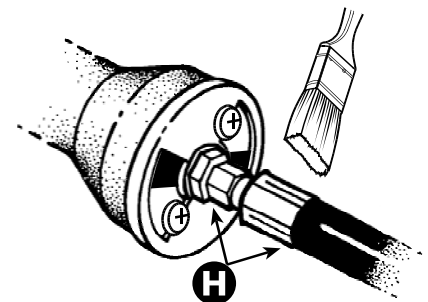

## **! WARNING**

**If growing soap bubbles persist throughout any portion of the Gas Leak Test, terminate use immediately. For assistance, contact your propane dealer or Barbour International, Inc. at 1-800-864-6194.**

# LIGHTING INSTRUCTIONS for BURNER COOKER

## ⚠ WARNING ⚠

**DO NOT** stand with head, body or arms over the cooker when lighting. Loose clothing and hair can catch fire.

**Follow the instructions exactly.** You should have already assembled hose/regulator to supply tank/cylinder and cooker. You should have already leak checked the connections, as instructed in this manual, prior to attempting to operate the cooker.

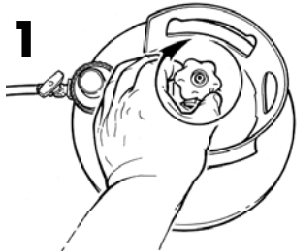

**1** Look at the tank/cylinder valve knob and the top will be labeled with the direction you need to turn it to OPEN (let gas flow) or CLOSE (shut gas flow off).

**Make sure the tank/cylinder valve is in the OFF position.**

Check this by rotating the valve in the CLOSE direction until it stops.

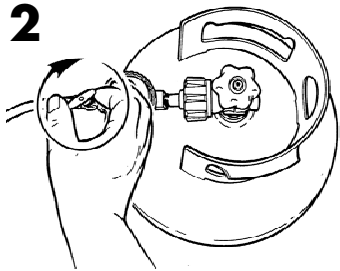

**2** Look at the regulator control valve and the top will be labeled with the direction you need to turn it to OPEN (let gas flow) or CLOSE (shut gas flow off). **Make sure the regulator control valve is in the OFF position.** Check this by rotating the valve in the CLOSE direction until it stops. **NOTE:** if the regulator control valve is left in the ON position, the Gas Flow Limiting device may be activated when the tank/cylinder valve is turned ON, which will limit gas flow and can prevent the cooker from lighting.

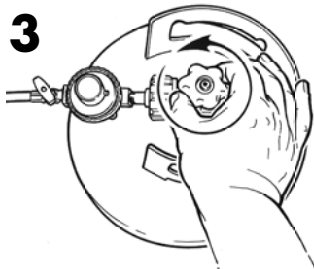

**3** Turn on the fuel supply by **S-L-O-W-L-Y** rotating the tank/cylinder valve one full turn in the OPEN direction. **HINT:** Turning the tank/cylinder valve quickly causes a sudden rush of gas that sometimes activates the Gas Flow Limiting Device. To prevent this, always rotate tank/cylinder valve S-L-O-W-L-Y.

**4** Position fireplace match or long lighter over the burner, then **S-L-O-W-L-Y** turn regulator control valve until you hear gas **HISSING** from the burner. Burner should light immediately. **CAUTION:** The flame may be difficult to see in direct sunlight. Do not remove match or lighter until you are sure flame is lit.

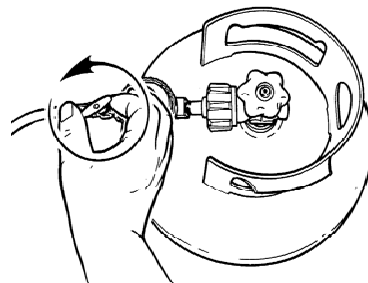
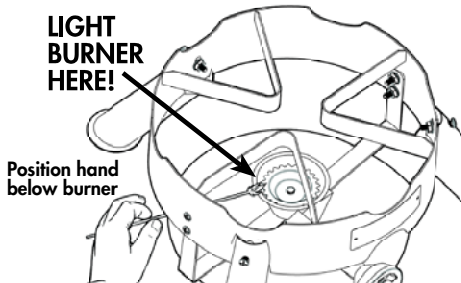

## ⚠ WARNING ⚠

**DO NOT** light burner at air intake

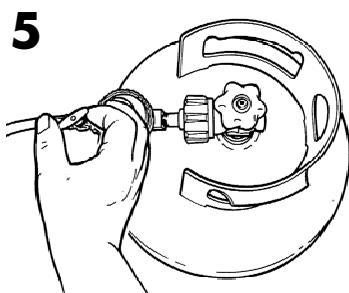
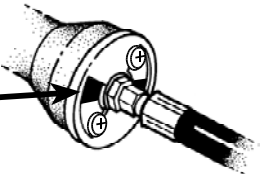

**5** If flame fails to light within 3 - 5 seconds, turn off gas flow by rotating the regulator valve in the CLOSE direction until it stops. Allow gas to evacuate/dissipate before attempting to relight the burner by repeating step 6. **NOTE:** If the cooker does not light within the first few attempts, there is a problem with the gas supply. Turn off the gas at the tank/cylinder and regulator. **DO NOT** attempt to operate the cooker until the problem is found and corrected. Refer to troubleshooting section of this manual.

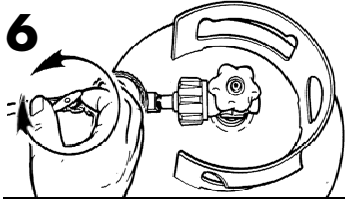

## 6 Adjust the regulator valve for the desired flame height.

**NOTE:** The regulator control knob controls flame intensity only. It is not an ON/OFF valve. Practice rotating the regulator control knob to become familiar with flame adjustment.

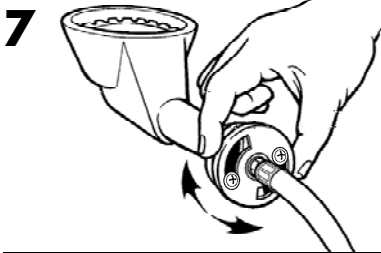

**7 Your burner has an air control shutter, rotate the shutter until a blue flame is achieved.** In direct sunlight, flame may appear clear. If the air shutter is tightened and will not turn. Turn OFF the burner and loosen screws enough to turn the air shutter and it will hold its position. Once ideal flame has been established, you can tighten the screws fully. **WARNING:** never adjust a hot burner. Only adjust when it is OFF and cool to touch.

## BURNER FLAME CHECK

Adjust flame height using regulator valve. Rotate air control shutter to achieve mostly blue flame. The air control shutter mounted on the front of burner helps to control the amount of air that mixes with the LP gas. A blue flame with little or no yellow flame indicates a proper air/gas mixture and provides the best heat. Adjust the air control shutter until the desired flame is achieved.

**NOTE:** Make sure the brass fitting on hose is screwed into the burner/air shutter and tightened securely. Do not over-tighten as the air shutter needs to move freely in order to adjust air intake. Check the attachment for proper connection everytime propane tank is connected to cooker.

**HINT:** Before lighting, turn air control shutter on the burner to an almost closed position. This increases the gas portion of the air/gas mixture and makes the burner easier to light. After lighting, turn air control shutter to an open position to achieve a better flame.

If burner flame does NOT ignite immediately, or is accidentally extinguished, turn LP Gas Cylinder Valve clockwise to OFF. Then turn regulator valve clockwise to OFF position. Wait 5 minutes for gas to evacuate before re-lighting, then repeat steps 1- 4 to re-light. Always use caution when re-lighting as cooker frame and cooking vessel will be hot.

If the burner does not light within the first few attempts, there is a problem with the gas supply. Turn off the gas at the cylinder and regulator. **DO NOT** attempt to operate the cooker until the problem is found and corrected. Refer to Troubleshooting on Pages 16 - 17.

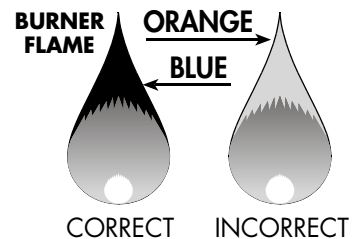

## HOW TO REIGNITE

Follow steps 1-4 on previous page, to reignite burner. Use caution when re-lighting the burner, as hot oil from cooking vessel may have splattered and run down the sides of the unit creating a slick surface. Use caution not to touch the cooker or cooking vessel when re-lighting the burner.

## TURNING OFF COOKER AND DISCONNECTING HOSE

**NOTE:** Turn off LP gas cylinder valve first to prevent gas from being left in the regulator hose system under pressure.

1. Turn OFF the LP gas cylinder valve **clockwise** until it stops.
2. Turn regulator valve to the OFF position, **clockwise** until it stops.
3. To disconnect Regulator Hose Assembly, turn the large coupling nut **counter-clockwise** by hand.

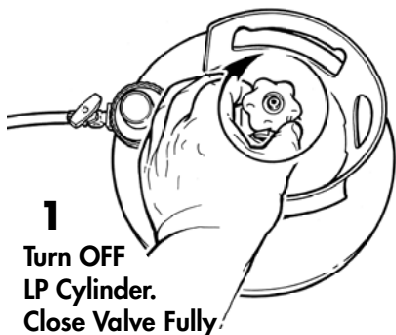

**1**  
Turn OFF  
LP Cylinder.  
Close Valve Fully.

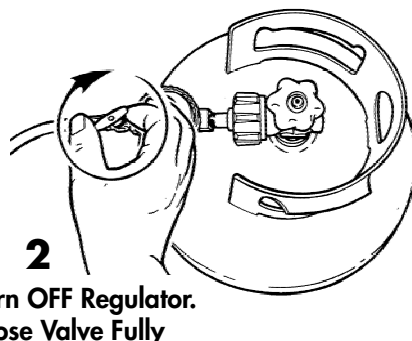

**2**  
Turn OFF Regulator.  
Close Valve Fully

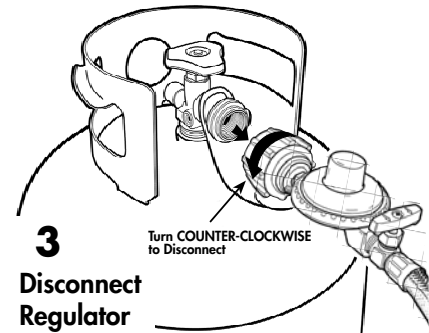

**3**  
Disconnect  
Regulator

## ⚠ WARNING ⚠

The LP gas cylinder valve must always be in the OFF or closed position when the cooker is not in use.

# TROUBLE SHOOTING GUIDE

| SYMPTOM  | CAUSE   | POSSIBLE SOLUTION   |
|--|---|---|
| Cooker lights but the flame remains very small   | Rapid gas flow from propane tank activates EXCESS FLOW safety device because regulator control valve is not in OFF position | Repeat lighting instructions and be certain to S-L-O-W-L-Y open cylinder valve one full turn, then S-L-O-W-L-Y open regulator valve to light burner. It may be necessary to disconnect, then reconnect the regulator to the cylinder in order to reset the gas flow system. After doing this, make certain regulator control valve is turned <b>CLOCKWISE</b> to <b>OFF</b> position. |
| Cooker will not light  | Orifice Hole is blocked   | Disconnect hose from burner. Clean and check burner for spiders, insect nests and debris  |
| Burner will not light and burner tube is clean   | Too much air and not enough gas   | Turn air shutter to almost closed position, then re-light the burner  |
|  | Not enough gas flow from propane tank   | Open cylinder valve all the way   |
|  | Low gas level in propane tank, or tank is empty   | Check gas level in propane tank, re-fill or exchange tank   |
|  | Damaged regulator hose assembly   | Contact <b>1-800-864-6194</b>   |
| Yellow, sooty, irregular flame   | Air shutter not adjusted correctly causing too much gas in mixture  | Adjust air shutter on the burner until flame is blue - See page 15  |
|  | Blockage in burner  | Clean and check burner for spiders, insect nests and debris   |
| Hissing or gurgling sounds coming through gas train from tank to burner<br> <b>WARNING</b><br>Do not use this appliance if gas leaks cannot be stopped and corrected. | Water in burner   | Check burner for moisture, make sure burner is dry  |
|  | Damaged hose  | Perform soapy water test to check for cracks in hose. See page 13   |
|  | Gas leak  | Perform soapy water test to check all connections - See page 13   |
| Flame has gone out   | Low gas level in propane tank, or tank is empty   | Check gas level in propane tank   |
|  | Too much wind   | Check wind direction and set cooker away from windy areas   |
|  | Blockage in burner  | Clean and check burner for spiders, insect nests and debris   |
|  | Water in burner   | Check burner for moisture, make sure burner is dry  |
|  | Damaged burner  | Contact <b>1-800-864-6194</b>   |

**NOTE:** Replacement Parts can be purchased at [www.thebayou.com](http://www.thebayou.com) or call **1-800-864-6194**.

## TROUBLE SHOOTING TIPS

Sometimes the burner does not light or has a only a meager match flame. Other times, the flame blows out, burns yellow, or there is a flame inside the burner tube. These symptoms are common and easy to remedy. **The following Trouble Shooting Tips cover most questions and problems associated with outdoor gas cooker appliances. Save this manual for future reference.**

### SYMPTOM #1:

Burner lights but the flame remains very small and will not increase for heat-up and cooking.

### CAUSE:

Both LP cylinder and regulator couplings contain an **EXCESS FLOW** safety device that shuts off 90 percent of gas flow should the hose be cut or severed. **Sometimes this safety device can be activated when lighting the burner.** Opening the cylinder valve **too quickly** can create the rapid flow of gas that activates the excess flow safety device.

### POSSIBLE SOLUTION:

Repeat **Lighting Instructions** steps 1 through 4 on on pages 14 - 15. Follow lighting instructions and be certain to S-L-O-W-L-Y open cylinder valve **one full turn**, then S-L-O-W-L-Y open regulator control valve when lighting.

### SYMPTOM #2:

Burner will not light.

### CAUSE:

Blockage in burner from insects, spider webs, dirt, dobee or wasp nests and debris. This is a frequent problem in the Deep South.

### POSSIBLE SOLUTION:

Clean burner to remove spiders, insect nests and other debris.

1. Turn gas OFF at LP cylinder valve and at regulator control knob.
2. Disconnect regulator hose assembly from burner and remove air control shutter.
3. Turn cooker frame upside down. Disconnect retaining nut from burner support bar, then remove burner from frame.
4. Loosen and disconnect central bolt from burner and remove flame spreader from burner cup.

**NOTE: Wear eye protection when cleaning burner.**

5. Use a narrow bottle brush or a stiff wire bent into a small hook to run through the burner tube. Push the bottle brush or bent wire back and forth through the burner tube.
6. Hold the burner with the tube facing down and spray water from a garden hose into the opening in the burner cup.
7. It may be necessary to repeat steps 5 & 6 until water flows freely out of the burner tube.
8. Wire brush entire surface of burner to remove food residue and dirt.
9. Wire brush bottom of flame spreader and side ports to be certain all grooves are free of debris.
10. Re-assemble flame spreader and air shutter on burner. Reinstall burner, heat shield and locking nut on support bar inside cooker stand. Re-connect hose to burner.
11. If burner is damaged, a replacement burner can be purchased.

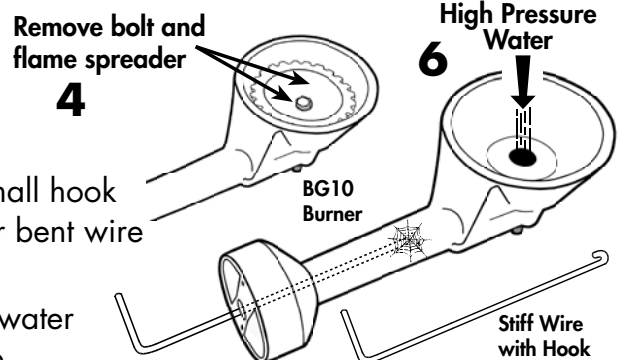
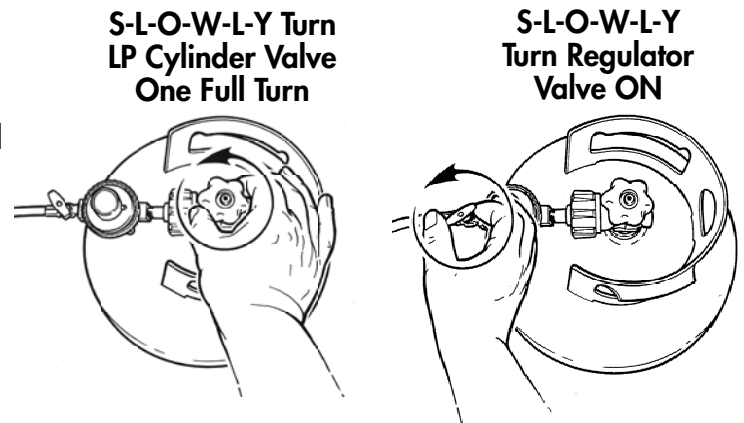

## GENERAL MAINTENANCE & STORAGE

Intense heat from the cooker will burn away paint from parts of the frame, windscreen flashing, and flame spreader. This is normal and will cause a slight 'odor' for a few minutes during the initial use. The exposed steel will rust. Occasional care must be taken to prolong the life of your cooker.

1. Before using this appliance to cook for the first time:
  - A. Light the cooker.
  - B. Run for 5 - 7 minutes and allow the cooker to burn away manufacturing oil and residue. It is normal to have a slight odor or smoke for a few minutes during the initial use.
2. Store cooker in a dry place. Do not store outside exposed to weather. Storage of a gas cooker appliance indoors is permissible only if the cylinder is disconnected. If storing cooker indoors, detach and leave LP cylinder outdoors. LP cylinders must be stored outdoors out of the reach of children and must NOT be stored in a building, garage or any other enclosed area.
3. Occasionally spray exposed areas of steel cooker frame after it has cooled with high temperature grill paint.
4. Spray WD-40 on the burner grid after it has cooled.

### **DANGER**

**Spray paint and other aerosols contain flammable PETROLEUM DISTILLATES under pressure. Flame from burner or heat from cooker may cause spray can to burst violently resulting in death, serious burns and bodily harm. Perform all touch up maintenance to a cool, dry cooker frame and burner, below 115°F (45°C).**

5. For long term storage, cover cast iron burners, regulator hose assembly, and jet tube in a plastic bag.
6. Spiders and small insects have been known to spin webs inside the burner tube. Obstructions in the burner tube interfere with the flow and mixture of air and gas through the burner. A clogged burner tube may result in a fire beneath the appliance. If this happens, clean the burner tube with a stiff, bent wire.
7. Turn air control shutter to closed position after each use to reduce chance of insect intrusion.
8. Do not tamper with or attempt repairs on the burners, frames, regulator valves, or LP cylinder. Allow only qualified LP gas dealers to make repairs. For replacement parts contact **Barbour International, Inc.**
9. **Always close LP cylinder valve and regulator valve after use.** Always use and store LP cylinder in an upright position. Never store or transport LP cylinders in occupied enclosures.
10. Check and tighten any loose hardware before each use.

### **WARNING**

**Discard any cooking vessel should cooking oil leak through pit holes. Leaking oil will ignite and cause a fire.**

12. Inspect entire cooker including regulator hose assembly and burner assembly before each use. Replace any damaged or worn parts. Use only parts specified by Barbour International, Inc.

# LIMITED WARRANTY

Barbour International, Inc. ("Vendor") warrants to the original retail purchaser of this gas fryer/cooker and no other person, that if this gas fryer/cooker is assembled and operated in accordance with the printed instructions accompanying it, then for a period of one (1) year from the date of purchase, all parts in such gas fryer/cooker shall be free from defects in material and workmanship. Vendor may require reasonable proof of your date of purchase from an authorized retailer or distributor. Therefore, you should retain your sales slip or invoice. This Limited Warranty shall be limited to the repair or replacement of parts, which prove defective under normal use and service and which Vendor shall determine in its reasonable discretion upon examination to be defective. Before returning any parts, you should contact Vendor's Customer Service Department using the contact information listed below. If Vendor confirms, after examination, a defect covered by this Limited Warranty in any returned part, and if Vendor approves the claim, Vendor will replace such defective part without charge. If you return defective parts, transportation charges must be prepaid by you. Vendor will return replacement parts to the original retail purchaser, freight or postage prepaid.

This Limited Warranty does not cover any failures or operating difficulties due to accident, abuse, misuse, alteration, misapplication, improper installation or improper maintenance or service by you or any third party, or failure to perform normal and routine maintenance on the gas fryer/cooker, as set out in this owner's manual. In addition, the Limited Warranty does not cover damage to the finish, such as scratches, surface chips and cracks, discoloration, rust or other weather damage, after purchase.

This Limited Warranty is in lieu of all other express warranties. Vendor disclaims all warranties for products that are purchased from sellers other than authorized retailers or distributors. AFTER THE PERIOD OF THE ONE (1)-YEAR EXPRESS WARRANTY, VENDOR DISCLAIMS ANY AND ALL IMPLIED WARRANTIES, INCLUDING WITHOUT LIMITATION THE IMPLIED WARRANTIES OF MERCHANTABILITY AND FITNESS FOR A PARTICULAR PURPOSE. FURTHER, VENDOR SHALL HAVE NO LIABILITY WHATSOEVER TO PURCHASER OR ANY THIRD PARTY FOR ANY SPECIAL, INDIRECT, PUNITIVE, INCIDENTAL, OR CONSEQUENTIAL DAMAGES. Vendor assumes no responsibility for any defects caused by third parties. This Limited Warranty gives the purchaser specific legal rights; a purchaser may have other rights depending upon where he or she lives. Some jurisdictions do not allow the exclusion or limitation of special, incidental or consequential damages, or limitations on how long a warranty lasts, so the above exclusion and limitations may apply to you.

Vendor does not authorize any person or company to assume for it any other obligation or liability in connection with the sale, installation, use, removal, return, or replacement of its equipment, and no such representations are binding on Vendor.



FOR OTHER PRODUCTS

# BAYOU CLASSIC<sup>®</sup>

**CHECK OUT  
OUR WEBSITE!**  
[www.thebayou.com](http://www.thebayou.com)

BCA000153-000