

This Owner's Manual is provided and hosted by [Appliance Factory Parts](http://ApplianceFactoryParts.com).

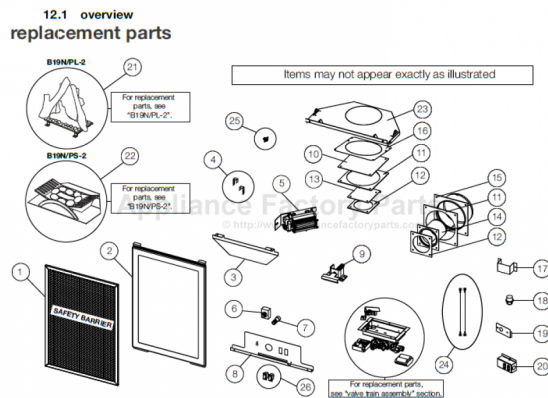

# Napoleon GD19N-2 Owner's Manual

[Shop genuine replacement parts for Napoleon GD19N-2](#)



[Find Your Napoleon Fireplace Parts - Select From 171 Models](#)

----- Manual continues below -----

# NAPOLLEON



DISTINCT DIRECT VENT FIREPLACES  
[napoleonfireplaces.com](http://napoleonfireplaces.com)

# Find your happy (fire)place.

Throughout the ages, people have gathered around fires to share in life's greatest joys. There's just something about the glow of flickering flames that makes special moments feel even warmer.

A Napoleon fireplace is uniquely designed to brighten the vibe of any room in your house. Napoleon has an incredible range of designer options to fit any vision.

A fire not only raises the warmth and ambiance of a room, it can raise the value of your home. A fireplace offers some of the highest returns of any remodeling project. And that should make you feel good all over.

And so you can keep enjoying that positive glow for years and years and years to come, every Napoleon fireplace is backed by the President's Limited Lifetime Warranty.

Torch™ - GT8 .....	4 - 5
Vittoria™ - GD19 .....	6 - 7
Park Avenue™ - GD82T-PAE .....	8 - 9
Tureen™ - GD82T-TE .....	10 - 11
Plazmafire™ 31 - WHD31 .....	12 - 13
Plazmafire™ 48 - WHD48 .....	14 - 15
Crystallo™ - BGD36CFG .....	16 - 17
Grandville™ 36 CF - BGD36CF .....	18 - 19
Napoleon's Outstanding Features .....	20 - 21
Detailed Specifications & Line Drawings .....	22 - 25



We are proud to be recognized as one of Canada's Best Managed Companies and are dedicated to providing quality, home comfort products for over 40 years and counting.

Cover Photo - The Plazmafire 48 shown with Black Surround.





**HOT SPOTS**  
RESEARCH STUDY

Napoleon's Hot Spots Research Study delivers in-home. In particular, how to help you add relaxation and functionality to rooms to enhance your memorable moments. Throughout this brochure we will share some of our findings. For more inspiration visit [napoleonfireplaces.com](http://napoleonfireplaces.com)

The Park Avenue™ shown with Rectangular

# Torch®

## Modern Simplicity

Napoleon's Torch® is an ultra modern fireplace with a slim design featuring a reflective, prism shaped firebox. The simplicity of the single luminous flame glows with artistic character. The perfect accent for bedrooms, bathrooms, kitchens, entranceways, hallways, offices, bars, lounges and waiting rooms. Versatile installations make the Torch® ideal for new construction and renovation projects, especially where space is limited.



Brushed Stainless Steel

### Options & Accessories



Adjustable Mounting Cabinets, Two Finish Options

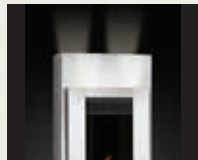

LED Accent Light Kit  
Four Lights Included



Push Button Auto Ignition

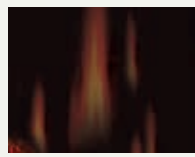

MIRRO-FLAME™ Porcelain Reflective Radiant Panels (included)



The Living Room, Kitchen  
prime targets for comfort  
get these rooms right



**GT8**

6,000 BTU's

Viewing Area: 10 1/2" W x 26" H

For more detailed specifications on this unit, see page 22

# Vittoria™

## Modern Simplicity

Its sleek, tall, slender design, the Vittoria™ gas fireplace easily installs into smaller wall applications... perfect for entranceways and corner wall installations. With the choice of a traditional log set and facing kits or mineral rock setting and contemporary facing kits, the Vittoria™ offers two entirely different looks. The Vittoria™ features Napoleon's exclusive NIGHT LIGHT™, electronic ignition with battery back-up and heat radiating ceramic glass. Either choice, traditional or modern, the Vittoria™ is the perfect fireplace for smaller living spaces.



Contemporary Black



Traditional Hammer Surround

### Options & Accessories



Ornamental Insets, Painted Metallic Black Finish



F45 & F60 Remote Controls On/Off with Digital Screen

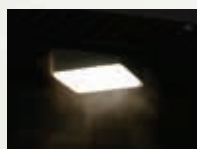

Exclusive NIGHT LIGHT™



Mineral Rock Burner Assembly

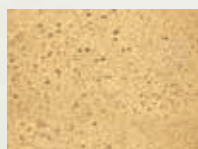

Decorative Sandstone Brick/Stone Panels

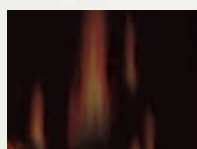

MIRRO-FLAME™ Porcelain Reflective Radiant Panels



Contemporary Brushed Stainless Steel Surround



**GD19**

Up to 11,500 BTU's

Viewing Area: 16 5/8" W x 24" H

For more detailed specifications on this unit, see page 22

The Vittoria™ shown with Traditional

# Park Avenue™

## European Styling

This tall, dark, handsome fireplace features a unique, clean design with advanced burner technology, creating the most realistic flames in the industry. The Park Avenue™ deluxe model is offered as a complete package including an exclusive NIGHT LIGHT™, heat circulating blower, multi-function remote control (controlling the flame, blower and NIGHT LIGHT™) and PHAZERAMIC™ advanced flame burner technology. Exclusive designer accessories make the Park Avenue™ perfect for any room in your home.



Rectangular Black Heritage Surround

### Options & Accessories



Andirons



Remote Control (Included)



Sandstone Herringbone  
Decorative Brick Panels



Exclusive NIGHT LIGHT™

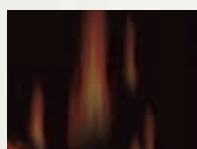

MIRRO-FLAME™ Porcelain  
Reflective Radiant Panels



Brushed Stainless Steel Surround  
Hearth Pad



*A fireplace can be  
warmth and intima  
great light, privacy  
spaces for added a*



**GD82T-PAE**

Up to 26,000 BTU's

Viewing Area: 22" W x 29" H

For more detailed specifications on this unit, see page 23

The Park Avenue™ shown with Arched Black Heron

# Tureen™

## Style and Elegance

Napoleon's Tureen™ features a totally unique modern style, a heavy gauge Medallion™ burner system, an exclusive NIGHT LIGHT™, stylish river rocks and a remarkable towering flame. The contemporary ceramic bowl, decorative accessories and concave satin chrome reflective panel give the Tureen™ its impressive design, certain to create a dynamic and extraordinary focal point wherever it is installed.

### Options & Accessories



Remote Control (Included)



MIRRO-FLAME™ Porcelain Reflective Radiant Panels



Rectangular Black Surround



Arched Black Heritage Pattern



**GD82T-TE**

Up to 26,000 BTU's  
Viewing Area: 22" W x 29" H

For more detailed specifications on this unit, see page 23

# Plazmafire™ 31

## Easy Installation

Ideal for modern and contemporary rooms, Napoleon's Plazmafire™ 31 features easy installation and all of the conveniences of a direct vent gas fireplace. Virtually endless installation possibilities, it's almost as easy as hanging a picture on the wall. With an impressive viewing area, 20,000 BTU's, exclusive Topaz CRYSTALINE™ ember bed and slate brick panels, Napoleon's Plazmafire™ is a great addition to our modern fireplace collection and to any room in your home.



Painted Black Rectangular Surround

### Options & Accessories



F45 & F60 Remote Controls  
On/Off with Digital Screen

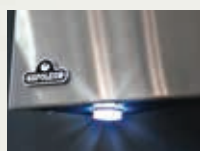

LED Light Kit  
Two Lights Included



Slate Brick Panel  
(included)



Blue Glass Embers



Amber Glass Embers



Black Glass Embers



Red Glass Embers

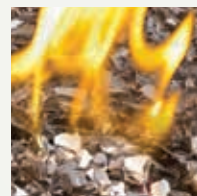

Topaz Glass Embers  
(Included)

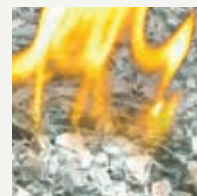

Clear Glass Embers



**WHD31**

20,000 BTU's

Viewing Area: 31 1/2" W x 16 1/2" H

For more detailed specifications on this unit, see page 24

# Plazmafire™ 48

## Stunning Appearance

Napoleon's wall hung Plazmafire™ 48 is a beautiful, modern gas fireplace. Designed with a focus on ease of installation, requires no special framing and can be quickly mounted to an existing wall with its simple mounting bracket. With virtually endless installation possibilities, it's almost as easy as hanging a picture on the wall. The Plazmafire™ 48 comes complete with MIRRO-FLAME™ Porcelain Reflective Radiant Panels and CRYSTALINE™ Topaz glass embers.



Painted Black Rectangular Surround

### Options & Accessories



Proflame II Remote Control (Included)



eFIRE Remote App with Proflame II System Available (Optional)



LED backlit light kit



Blue Glass Embers



Amber Glass Embers



Black Glass Embers



Red Glass Embers

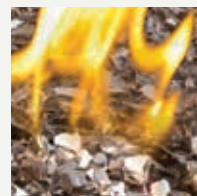

Topaz Glass Embers (Included)

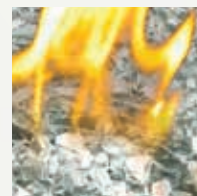

Clear Glass Embers



*Napoleon's Hot Spots  
show over 90% of people  
desire a fireplace in*



## **WHD48**

Up to 26,000 BTU's

Viewing Area: 36 1/2" W x 16 1/2" H

For more detailed specifications on this unit, see page 24

The Plazmafire™ 48 st

# Crystallo™

It's Crystal Clear...

A clean face design with an exclusive CRYSTALINE™ ember bed embraces Napoleon's collection of modern fireplaces. The Crystallo™ provides inspiration to create a hearth experience that focuses on warmth, beauty and style. The Crystallo™ comes included with MIRRO-FLAME™ Porcelain Reflective Radiant Panels and a multi-function LED spectrum light strip. The LED light strip transitions through the entire RGB color range or can be set to any color (including white) that suits your décor and act as an exclusive NIGHT LIGHT™. A unique hearth idea that sparkles with modern elegance!



F45 & F60 Remote Controls  
On/Off with Digital Screen

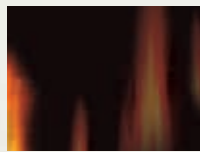

MIRRO-FLAME™ Porcelain  
Reflective Radiant Panels  
(included)

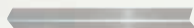

Satin Chrome Lower Trim



Blue Glass Embers



Amber Glass Embers



Black Glass Embers



Red Glass Embers

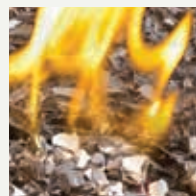

Topaz Glass Embers  
(Included)

LOW ENERGY  
**LED**  
TECHNOLOGY



**BGD36CFG**

Up to 17,000 BTU's

Viewing Area: 40" W x 34" H

For more detailed specifications on this unit, see page 25



**LED Spectrum Light Strip**

The LED lights transition through an array of colors.  
(feature image shown above shows the color transition)

The Crystallo™ Shown with Dia

# Grandville™ 36 CF

## Best of Both Worlds

The Napoleon Grandville™ 36 CF gas fireplace with heat radiating glass, beautiful display of YELLOW DANCING FLAMES® and realistic PHAZER® log set makes it the perfect complement to a crisp, contemporary design. The perfect fireplace for those wanting a traditional look but a clean face contemporary style, the Grandville™ 36 CF gives you the best of both worlds.



F45 & F60 Remote Controls  
On/Off with Digital Screen



MIRRO-FLAME™ Porcelain  
Reflective Radiant Panels  
(included)



Mineral Rock Kit



Diamond Dust Convex Surround



**BGD36CF**

Up to 17,000 BTU's

Viewing Area: 40" W x 34" H

For more detailed specifications on this unit, see page 25

The Grandville™ 36 CF s

# Outstanding Features

of Napoleon's Advanced Technology



## Advanced Burner Technology

Napoleon's sophisticated burner system offers superior flame technology. Strategically placed burner ports create the most realistic **YELLOW DANCING FLAMES**® in the industry.



## Finely Tuned Precision Valves

Surrounded with a protective cast aluminum jacket, the precision valves allow for ultimate reliability and 100% **SAFE GUARD**™ gas control system.

## Minimum 30% savings on heating costs with Zone Heating



Zone Heating means you are heating the rooms that you use the most with an alternate heat source, like a Napoleon gas fireplace. Zone Heating is the obvious solution for families concerned about rising fuel costs.



## Outstanding

Fine details of Napoleon handcrafted lifetime.

## Safety Screen

Napoleon, have developed aesthetically appliance to peace of m

## Direct Vent System

1. Zero clearance to combustible framing\*
2. Forced convection heated room air
3. Radiant heat
4. High Heat Ceramic or Tempered Glass increases the radiant heat that is dispersed throughout the room. Save up to 30% on energy costs with radiant heat and Zone Heating
5. Cool room air is naturally drawn through the lower opening, circulates around the firebox, and expels into the living space as warm air
6. Optional air circulating variable speed blower with high temperature bearings increases efficient heating
7. Advanced ceramic burner system (selected models)
8. MIRRO-FLAME™ Porcelain Reflective Radiant Panels further increase radiant heat (optional on most models)
9. Advanced burner technology produces the most realistic flames in the industry
10. Sealed combustion chamber
11. Optional rear exhaust (selected models)

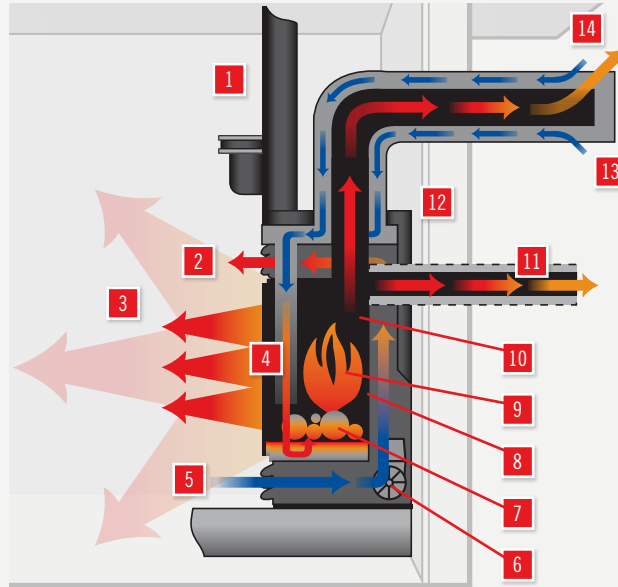

12. Efficient heat exchange system
13. Combustion air inlet
14. Flue gas outlet

With over 35 years of research and development, Napoleon has perfected direct vent technology to offer you a fireplace, stove or insert that easily fits into your lifestyle.

With Napoleon's direct vent technology, you can design and install your fireplace in unique locations where it wasn't possible before with traditional masonry fireplaces. Even your basement can be transformed into a warm, inviting oasis for your family and friends to enjoy.

Whether you are renovating, building or replacing an inefficient fireplace product, Napoleon helps guide you in the right direction to find the product that's right for you and your home. Napoleon Fireplaces are a smart investment that will bring many years of affordable luxury to you and your family.

\*See installation manual for details

## Direct Vent Power Venting System

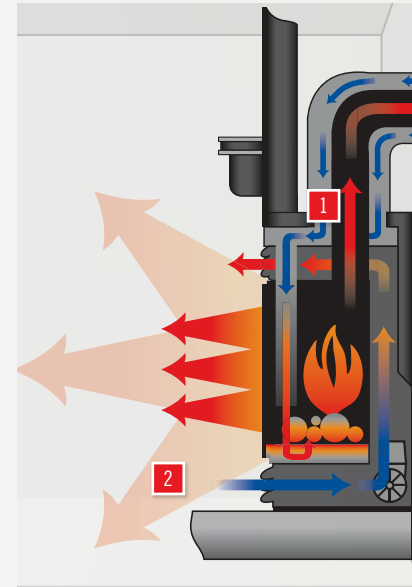

1. Suitable for exhaust products with various vent diameters
2. Installation friendly maintenance free durable construction
3. Blower mounted outside at terminal with WHISPER QUIET™ operation inside

Napoleon's power venting system allows direct vent installations. The option of having the fireplace, along with the ability to "s... installation when the desired fireplace loc... an outside wall. The blower that pulls th... mounted outside at the terminal which p... inside the home.

**Available for Select Models**

## Torch®

Shown on pages 4 & 5

\*Fronts/Surrounds may change unit dimensions

Model	BTU's (Input)		Venting 4" x 7"	Height		Front Width		Depth		Glass Type	Viewing Area	
	Natural Gas	Propane		Actual	Framing	Actual	Framing	Actual	Framing		Height	Width
GT8	6,000	6,000	Rear	43 3/4"	44 1/4"	12"	14 1/2"	6 3/4"	7"	Ceramic	26"	10 1/2"

Certified under Canadian and American National Standards.

## Vittoria™

Shown on pages 6 & 7

\*Fronts/Surrounds may change unit dimensions

Model	BTU's (Input)		Venting 4" x 7"	Height		Front Width		Depth		Glass Type	Viewing Area	
	Natural Gas	Propane		Actual	Framing	Actual	Framing	Actual	Framing		Height	Width
GD19	11,500	11,000	Top/Rear	34 1/8"	34 3/8"	21 3/4"	22 1/4"	13"	13 1/4"	Ceramic	24"	16 5/8"

Certified under Canadian and American National Standards.

## Park Avenue™

Shown on pages 8 & 9

\*Fronts/Surrounds may change unit dimensions

Model	BTU's (Input)		Venting 4" x 7"	Height		Front Width		Depth		Glass Type	Viewing Area		
	Natural Gas	Propane		Actual	Framing	Actual	Framing	Actual	Framing		Height	Width	End
GD82T-PAE	26,000	26,000	Top	58"	58 1/4"	28"	29"	22 1/8"	22 1/2"	Ceramic	29"	22"	5 1/2"

Certified under Canadian and American National Standards.

## Tureen™

Shown on pages 10 & 11

\*Fronts/Surrounds may change unit dimensions

Model	BTU's (Input)		Venting 4" x 7"	Height		Front Width		Depth		Glass Type	Viewing Area		
	Natural Gas	Propane		Actual	Framing	Actual	Framing	Actual	Framing		Height	Width	End
GD82T-TE	26,000	26,000	Top	58"	58 1/4"	28"	29"	22 1/8"	22 1/2"	Ceramic	29"	22"	5 1/2"

Certified under Canadian and American National Standards.

Figures may vary with individual conditions such as floor plan layout, insulation value/heat loss of the house and geographical location. Measurements to be used as a guide only. Consult your owner's manual for complete and up-to-date installation instructions and proper clearances to combustible materials.

## Plazmafire™ 31

Shown on pages 12 & 13

\*Fronts/Surrounds may change unit dimensions

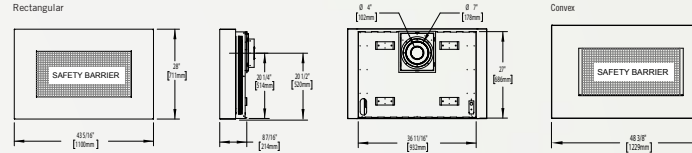

Model	BTU's (Input)		Venting 4" x 7"	Height		Front Width		Depth		Glass Type	Viewing Area	
	Natural Gas	Propane		Actual	Framing	Actual	Framing	Actual	Framing		Height	Width
WHD31 - Rectangular	20,000	16,000	Rear	28"	N/A*	43 5/16"	N/A*	8 7/16"	N/A*	Ceramic	16 1/2"	31 1/4"
WHD31 - Convex	20,000	16,000	Rear	28 7/16"	N/A*	48 3/8"	N/A*	10 3/4"	N/A*	Ceramic	16 1/2"	31 1/4"

Certified under Canadian and American National Standards.

## Plazmafire™ 48

Shown on pages 14 & 15

\*Fronts/Surrounds may change unit dimensions

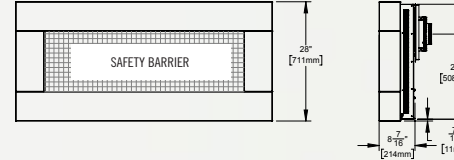

Model	BTU's (Input)		Venting 5" x 8"	Height		Front Width		Depth		Glass Type	Viewing Area	
	Natural Gas	Propane		Actual	Framing	Actual	Framing	Actual	Framing		Height	Width
WHD48	28,000	28,000	Rear	28"	N/A	60 3/16"	N/A	8 7/16"	N/A	Ceramic	16 1/2"	31 1/4"

Certified under Canadian and American National Standards.

## Crystallo™ - BGD36CFG

Shown on pages 16 & 17

\*Fronts/Surrounds may change unit dimensions

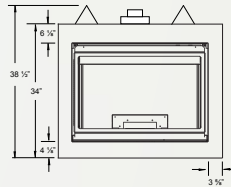

Model	BTU's (Input)		Venting 4" x 7"	Height		Front Width		Depth		Glass Type	Viewing Area	
	Natural Gas	Propane		Actual	Framing	Actual	Framing	Actual	Framing		Height	Width
BGD36CFG	17,000	17,000	Top/Rear	38 1/2"	38 3/4"	40"	40 1/2"	17"	17 1/4"	Tempered	19"	31 1/4"

Certified under Canadian and American National Standards.

## Granville™ 36 - BGD36CF

Shown on pages 18 & 19

\*Fronts/Surrounds may change unit dimensions

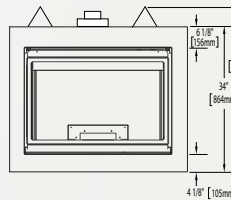

Model	BTU's (Input)		Venting 4" x 7"	Height		Front Width		Depth		Glass Type	Viewing Area	
	Natural Gas	Propane		Actual	Framing	Actual	Framing	Actual	Framing		Height	Width
BGD36CF	17,000	17,000	Top/Rear	38 1/2"	38 3/4"	40"	40 1/2"	17"	17 1/4"	Tempered	19"	31 1/4"

Certified under Canadian and American National Standards.

Figures may vary with individual conditions such as floor plan layout, insulation, etc. Measurements to be used as a guide only. Consult your owner's manual for complete and up-to-date installation instructions.



# NAPOLEON - CELEBRATING OVER 40 YEARS OF HOME COMFORT PRODUCTS



24 Napoleon Road, Barrie, Ontario, Canada L4M 0G8  
103 Miller Drive, Crittenden, Kentucky, USA 41030  
7200 Trans Canada Highway, Montreal, Quebec, Canada H4T 1A3

Tel: 1-866-820-8686  
napoleonfireplaces.com

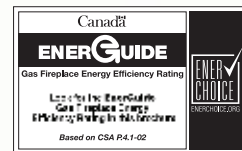

Authorized Dealer

Consult your owner's manual for complete installation instructions and proper clearances to combustible materials. Check all local and national building codes and gas regulations. All specifications are subject to change without prior notice due to on-going product improvements. Products may not be exactly as shown. Flame height and activity is influenced by varying vent configurations and may not appear as shown. Napoleon is a registered trademark of Wolf Steel Ltd. © Wolf Steel Ltd. EnerGuide - A Canadian efficiency standard based on frequent, short start-up and cool-down cycles. All appliances sold in Canada are subject to this EnerGuide rating system. AFUE- A US efficiency standard (Department of Energy) based on extended on/off cycles, more typical of fireplace usage. Steady State - Reflects the highest possible overall heating efficiency.