

This Owner's Manual is provided and hosted by [Appliance Factory Parts](http://www.appliancefactoryparts.com).



MAGIC CHEF HMBR440SE Owner's Manual

[Shop genuine replacement parts for MAGIC CHEF
HMBR440SE](#)



[Find Your MAGIC CHEF Refrigerator Parts - Select From 316 Models](#)

----- Manual continues below part list -----

Available Replacement Parts for MAGIC CHEF HMBR440SE

[20122990019](#)

Long Adjustable Foot

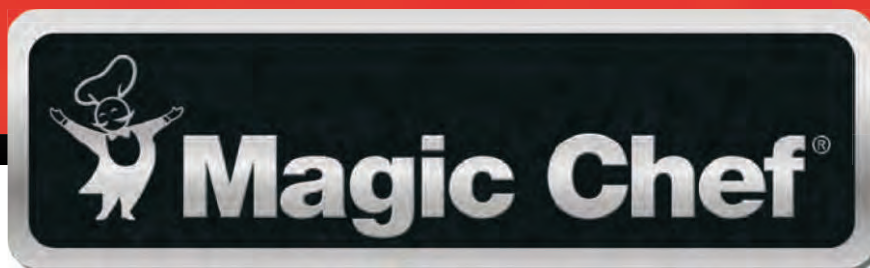

4.4 Cu. Ft. Compact Refrigerator

User's Manual

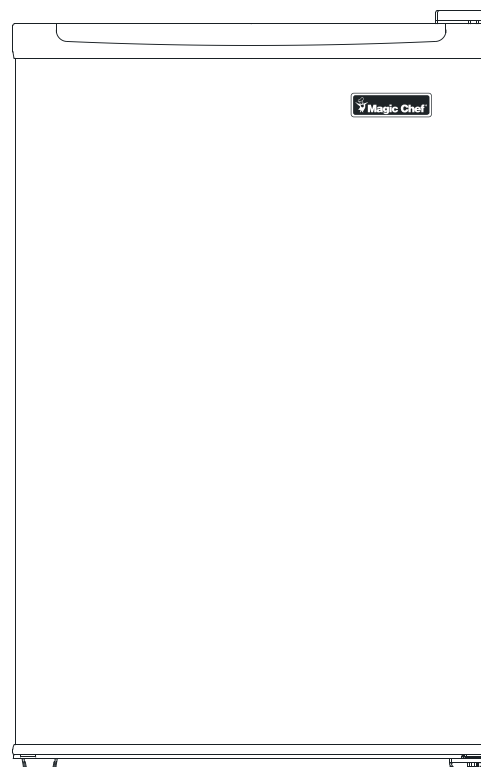

Model HMBR440WE / HMBR440BE / HMBR440SE

**PLEASE READ THIS MANUAL CAREFULLY BEFORE USING YOUR
REFRIGERATOR AND KEEP IT FOR FUTURE REFERENCE.**



Product Registration

Thank you for purchasing a Magic Chef® product. The first step to protect your new product is to complete the product registration on our website: www.mcappliance.com/register. The benefits of registering your product include the following:

1. Registering your product will allow us to contact you regarding a safety notification or product update.
2. Registering your product will allow for more efficient warranty service processing when warranty service is required.
3. Registering your product could act as your proof of purchase in the event of insurance loss.

Once again, thank you for purchasing a Magic Chef® product.

TABLE OF CONTENTS

NAMES OF THE PARTS.....	3
SPECIFICATIONS.....	3
IMPORTANT SAFETY INSTRUCTIONS.....	4 - 5
INSTALLATION INSTRUCTION	
BEFORE USING YOUR REFRIGERATOR	6
INSTALLING YOUR REFRIGERATOR	6
ELECTRICAL CONNECTION.....	6 - 7
OPERATING YOUR REFRIGERATOR	
TEMPERATURE CONTROL.....	8
ICE TRAY.....	8
THE CHILLER COMPARTMENT.....	8
HOW TO DEFROST	8 - 9
HOW TO CHANGE THE INTERIOR LIGHT.....	9
CHANGING THE REVERSIBLE DOOR	10 - 12
CARE AND MAINTENANCE	
CLEANING YOUR REFRIGERATOR.....	13
VACATION TIME.....	13
MOVING YOUR REFRIGERATOR.....	13
ENERGY SAVING TIPS.....	13
TROUBLESHOOTING GUIDE.....	14 - 15
REFRIGERATOR WARRANTY.....	16

NAMES OF THE PARTS

MODEL NO. HMBR440WE/HMBR440BE/HMBR440SE

- 1- Top hinge with cover
- 2- Chiller compartment
- 3- Drip tray
- 4- Temperature control
- 5- Full shelf
- 6- Full shelf
- 7- Crisper cover
- 8- Crisper
- 9- Leveling leg
- 10- Door bin
- 11- Can holders (Total 3)
- 12- Door bin
- 13- Door bin
- 14- Bottom hinge with leveling leg

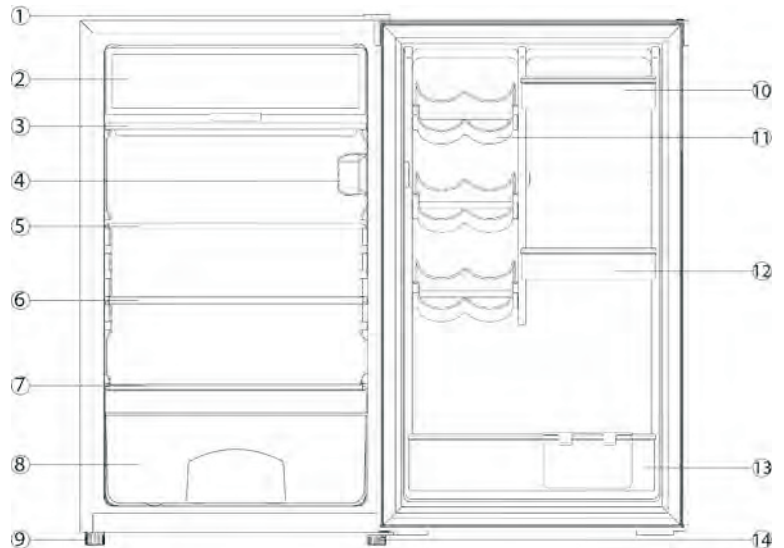

⚡ WARNING ⚡: Never touch the interior of the Freezer Chamber or frozen foods in the compartment with wet hands as this could result in frost bite.

SPECIFICATIONS

Model

HMBR440WE/HMBR440BE/HMBR440SE

Product Description	Magic Chef Refrigerator		
Model No.	HMBR440WE/HMBR440BE/HMBR440SE		
Capacity	4.4 Cu. Ft.		
Unit Dimensions (inches)	Width	Height	Depth
	19.5"	33.1"	22.0"
Net Weight (lbs)	57(lbs)		

IMPORTANT SAFETY INSTRUCTIONS

	<p>To reduce the risk of fire, electrical shock, or injury when using your refrigerator, follow these basic precautions:</p>
<ul style="list-style-type: none"> • Read all instructions before using the refrigerator. • DANGER or WARNING: Risk of child entrapment. • To avoid the possibility of child entrapment, please take the following precautions before throwing out the refrigerator. <ul style="list-style-type: none"> - Remove all doors from the unit. - Leave the shelves in place so that children may not easily climb inside. • Never allow children to operate, play with, or crawl inside the refrigerator. • Never clean refrigerator parts with flammable fluids. The fumes can create a fire hazard or explosion. • Do not store or use gasoline or any other flammable vapors and liquids in the vicinity of this or any other refrigerator. The fumes can create a fire hazard or an explosion. <p style="text-align: center;">-Save these instructions-</p>	



To reduce the risk of fire, electrical shock, or injury follow these basic precautions when using your refrigerator.

- 1) **WARNING**—Keep ventilation openings, in the appliance enclosure or in the built-in structure, clear of obstruction.
- 2) **WARNING**—Do not use mechanical devices or other means to accelerate the defrosting process, other than those recommended by the manufacturer.
- 3) **WARNING**—Do not damage the refrigerant tubing to increase the risk of a leak when handle, move and use of refrigerator.
- 4) **WARNING**—Do not use electrical appliances inside the food storage compartments of the appliance, unless they are of the type recommended by the manufacturer.
- 5) **WARNING**—**DANGER:** Never allow children to play with, operate, or crawl inside the refrigerator. Risk of child entrapment. Before you throw away your old refrigerator or freezer:
 - Take off the doors
 - Leave the shelves in place so that children may not easily climb inside.
- 6) The appliance has to be unplugged before carrying out user maintenance on the appliance.
- 7) This appliance can be used by children age 8 years and above and persons with reduced physical sensory or mental capabilities or lack of experience and knowledge if they have been given supervision or instruction concerning use of the appliance in a safe way and understand the hazards involved. Children should not play with the appliance. Cleaning and maintenance should not be made by children without supervision.
- 8) If the component part is damaged, it must be replaced by the manufacturer, its service agent or similar qualified persons in order to avoid a hazard.
- 9) Please abandon the refrigerator according to local regulations as the unit contains flammable blowing gas and refrigerant.
- 10) Follow local regulations regarding disposal of the appliance due to flammable refrigerant and blowing gas. All refrigeration products contain refrigerants, which under the guidelines of federal law must be removed before disposal. It is the consumer's responsibility to comply with federal and local regulations when disposing of this product.

- 11) This appliance is intended to be used in household and similar environments such as
 - staff kitchen areas in shops, offices and other working environments;
 - farm houses and by clients in hotels, motels and other residential type environments;
 - bed and breakfast type environments;
 - catering and similar non-retail applications.
- 12) Do not store or use gasoline or any inflammable liquors and liquids inside or in the vicinity of refrigerator.
- 13) Do not use an extension cord with this appliance. If the power cord is too short, have a qualified electrician install an outlet near the appliance. Use of an extension can negatively affect the unit's performance.



Caution: risk of fire



IT IS HAZARDOUS FOR ANYONE OTHER THAN AUTHORIZED SERVICE PERSONNEL TO CARRY OUT SERVICES OR REPAIRS INVOLVING THE REMOVAL OF COVERS.



TO AVOID THE RISK OF AN ELECTRICAL SHOCK DO NOT ATTEMPT REPAIRS YOURSELF.

INSTALLATION INSTRUCTIONS

Before Using Your Refrigerator

- Remove the exterior and interior packing.
- Before connecting the refrigerator to the power source, let it stand upright for approximately 4 hours. This will reduce the possibility of a malfunction in the cooling system from improper handling during transportation.
- Clean the interior surface with lukewarm water using a soft cloth. (Cleaning instruction on page 11)

Installing Your Refrigerator

- This appliance is designed to be free standing only, and should not be recessed or built-in.
- Place your refrigerator on a floor that is strong enough to support the refrigerator when it is fully loaded.
- Allow 5 inches of space between the back and sides of the refrigerator, which allows the proper air ventilation. Adjust the feet to keep the refrigerator level.
- Locate the refrigerator away from direct sunlight and sources of heat (stove, heater, radiator, etc.). Direct sunlight may affect the acrylic coating and heat sources may increase electrical consumption. Ambient temperature below 50°F (10°C) or above 85°F (29.4°C) will hinder the performance of this appliance. **This unit is not designed for use in a garage or any other outside installation.**
- Avoid locating the refrigerator in moist areas.
- Plug the refrigerator into dedicated, properly installed-grounded wall outlet. Do not under any circumstances cut or remove the third (ground) prong from the power cord. Any questions concerning power and/or grounding should be directed toward a certified electrician or an authorized service center. **This unit is not designed to be installed in an RV or used with an inverter.**
- After plugging the appliance into a wall outlet, turn the unit on and allow the unit to cool down for 2~3 hours under before placing food in the refrigerator or freezer compartment.

Electrical Connection

⚡WARNING⚡

Improper use of the grounded plug can result in the risk of electrical shock. If the power cord is damaged, have it replaced by an authorized service center.

This refrigerator should be properly grounded for your safety. The power cord of this refrigerator is equipped with a three-prong plug which mates with standard three prong wall outlets to minimize the possibility of electrical shock.

Do not, under any circumstances, cut or remove the third ground prong from the power cord supplied.

This refrigerator requires a standard 115 Volt A.C. ~/60Hz electrical outlet with three-prong ground.

This refrigerator is not designed to be used with an inverter.

The cord should be secured behind the refrigerator and not left exposed or dangling to prevent accidental injury.

Never unplug the refrigerator by pulling the power cord. Always grip the plug firmly and pull straight out from the receptacle.

Do not use an extension cord with this appliance. If the power cord is too short, have a qualified electrician or service technician install an outlet near the appliance. Use of an extension cord can negatively affect the performance of the unit.

If any problems with the appliance persist, please contact our Customer Service Dept. to consult with a representative at **888 775-0202** or visit our website to request warranty service at **www.mcappliance.com**.

OPERATING YOUR REFRIGERATOR

Temperature Control

- Your refrigerator has one control for regulating the temperature. The temperature control is located on the upper right hand corner of the interior compartment.
- The first time you turn the unit on, adjust the temperature control knob to "5" and run for at least 2 hours before putting foods inside. This will ensure the cabinet is thoroughly chilled before food is put in.
- The range of the refrigerator temperature control is from position "1" to "5". Adjust the temperature control to the setting that best suits your needs. The setting of "3" should be appropriate for home or office refrigerator use.
- To turn off the refrigerator, please turn the temperature control knob to "0". Please note that turning the temperature control knob to "0" position stops the cooling cycle, but does not disconnect the power supply to the refrigerator.

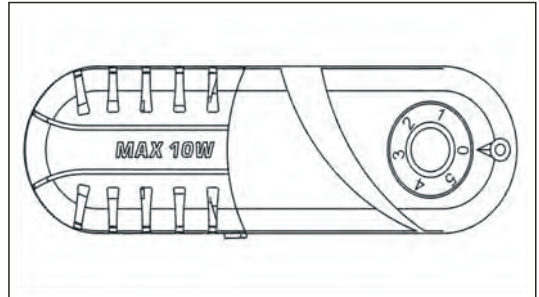

• **NOTE;**

- If the unit is unplugged, loses power; you must wait 3 to 5 minutes before restarting the unit. If you attempt to restart before this time delay, the refrigerator will not start.
- Large amounts of food will lower the cooling efficiency of the appliance.
- Do not place the foods on the air outlet, and leave spaces for airflow.
- If you choose to change the thermostat setting, adjust thermostat control by one increment at a time. Allow several hours for temperature to stabilize between adjustments.

Ice Tray

- Recommended temperature control setting for ice making is "5".
- Fill the ice cube tray (2/3 capacity) with cold water and place the tray on the bottom of the chiller compartment to freeze properly.
- To eject the ice cubes from the tray, place over the ice bucket and twist slightly.
- Re-set the temperature control to setting "3".



The Chiller Compartment

- This compartment is designed for the ice making and short-term storage of some commercially frozen foods.
- The temperature of the chiller compartment may not reach temperature low enough to store frozen foods and works well when the food is already frozen prior to storage.
- Place frozen food into the freezer as quickly as possible after purchase. If there are instructions on the packet, carefully follow these instructions regarding storage times.

How To Defrost

This refrigerator is equipped with a "Push Button" defrost thermostat system. To activate the defrost cycle, simply push (in) the red defrost button located in the center of the control knob/dial (do not turn the control knob/dial to zero/off). The defrost cycle is initiated immediately. When defrosting is complete, the "Push Button" will release (pop-out) automatically and resume normal operating conditions at the same temperature setting.

NOTE: If the “Push Button” is activated (pushed-in) accidentally, it will not be possible to “manually” pull-out the push button (deactivate the defrost cycle). You must let the defrost cycle run its course.

Defrosting of your refrigerator should take place whenever ice build-up inside the freezer compartment reaches 1/4” (6mm) thick. Defrosting may take a few hours, depending on the amount of accumulated ice and ambient indoor temperature. To speed up the defrosting process, remove all frozen foods from the freezer section. Leaving the door partially ajar for a short period of time will also speed up the process.

Important: You must remember to close the refrigerator door before the defrost cycle terminates and normal operating conditions resume automatically. The drip tray should be in position directly below the freezer compartment to catch condensed water during defrosting.

Note: Never use sharp or pointed instruments to remove ice from the freezer compartment. The freezer compartment contains refrigerated gas lines and if accidentally punched/pierced, will render the refrigerator inoperable and void the manufacturer’s warranty.

DO NOT ALLOW THE REFRIGERATOR TO CONTINUE OPERATION IF THE FREEZER COMPARTMENT IS PIERCED.

After defrosting is complete, set the control to maximum for 2 to 3 hours before returning to the desired position. When the refrigerator is not to be used for a long period of time, disconnect the appliance from the electrical supply and leave the door partially open. This will help to reduce mold and mildew build-up.

Note: Wait 3 to 5 minutes before attempting to restart the refrigerator if operation has been interrupted.

How To Change the interior light

NOTE: All parts removed must be saved to do the reinstallation of the light bulb. Before removing the light bulb, unplug the appliance from the power supply. Failure to do so could result in electrical shock or personal injury.

1. Hold the lamp cover and push toward inside of the cabinet
2. Remove the lamp cover.
3. Unscrew the old bulb and install the new bulb.
4. Re-install the lamp cover.

CHANGING THE REVERSIBLE DOOR

CAUTION: To avoid personal injury to yourself and/or property, we recommend someone assist you during the door reversal process.

1. Tilt the unit slightly towards the rear and prop it securely. Two people are required to tilt the unit during the door reversal process.

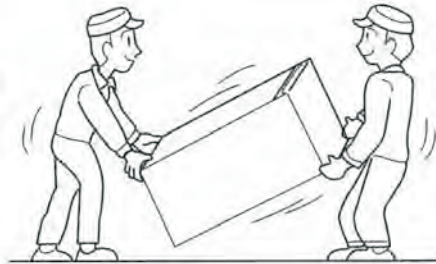

2. Remove the top right hinge cover.

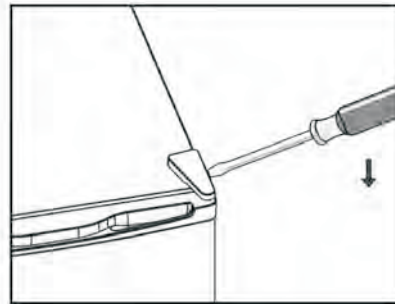

3. Undo the screws. Then remove the hinge bracket.

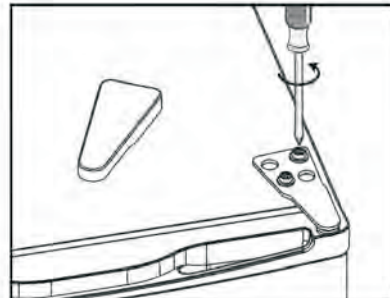

4. Remove the top left screw cover.

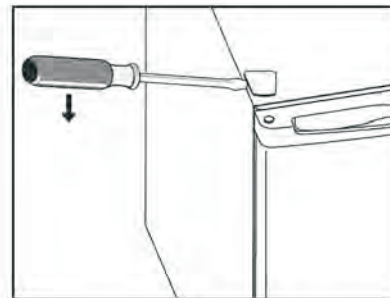

5. Move the core cover from left side to right side. And then lift the door and place it on a padded surface to prevent it from scratching.

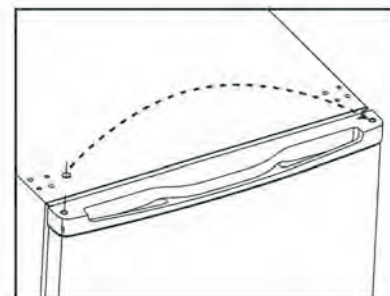

6. Remove the screws and bottom hinge. Then remove the adjustable feet from both side.

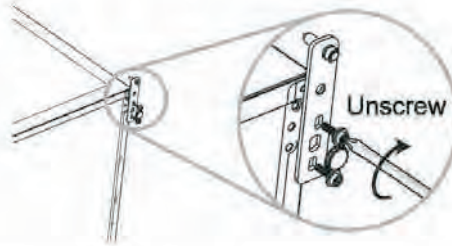

7. Unscrew and remove the bottom hinge pin, turn the bracket over and replace it.

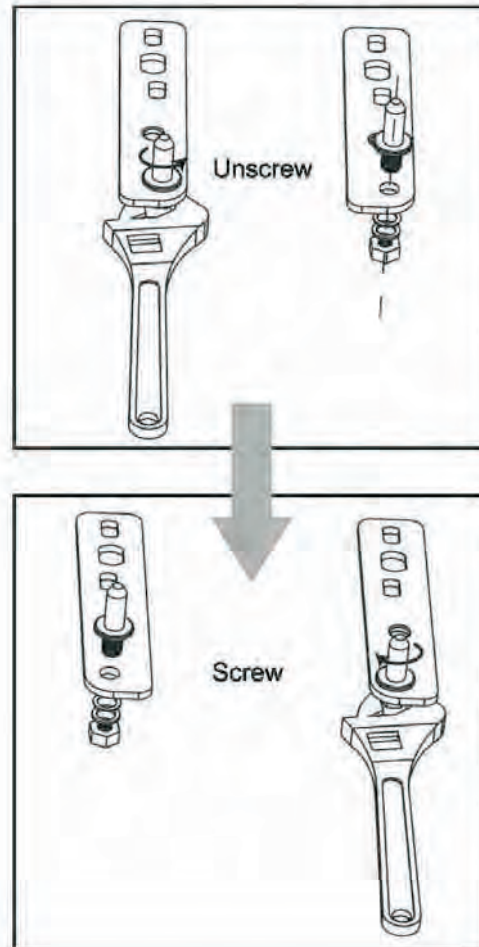

8. Refit the bracket fitting the bottom hinge pin. Replace both adjustable feet.

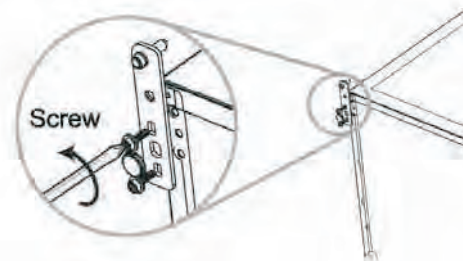

9. Place the door back on. Ensure the door is aligned horizontally and vertically so that the seals are closed on all sides before finally tightening the top hinge.
10. Insert the hinge bracket and screw it to the top of the unit.
11. Use a spanner to tighten it if necessary.

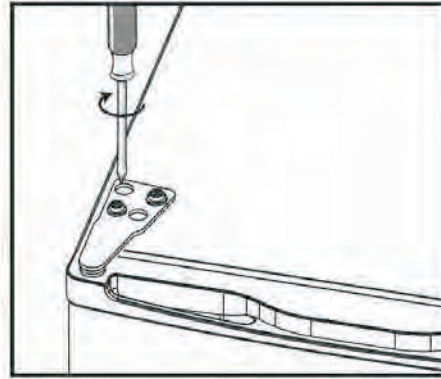

12. Put the hinge cover and the screw cover back.

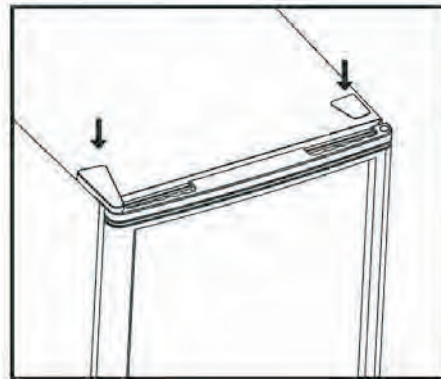

13. With the door closed, check that the door is aligned horizontally and vertically and that the seals are closed on all sides before finally tightening the bottom hinge. Re-adjust the leveling feet as needed.

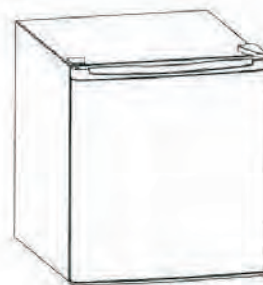

CARE AND MAINTENANCE

Cleaning Your Refrigerator

- Upon installation of your new appliance, it is recommended that it be cleaned thoroughly.
- Turn the temperature control knob to “0” and then unplug the unit from the wall outlet.
- Remove all food content.
- Wash the inside with a damp warm cloth soaked in lukewarm water and baking soda solution. The solution should be about 2 tablespoons of baking soda to a quart of water.
- Be sure to keep the door gasket (seal) clean to keep the unit running efficiently.
- The outside of the refrigerator should be cleaned with mild detergent and warm water.
- Dry the interior and exterior with a soft cloth.

Vacation Time

- Turn the temperature control knob to “0” and then unplug the unit from the wall outlet.
- Remove all the food.
- Clean the refrigerator.
- Leave the door open slightly to avoid possible formation of condensation, mold, or odor.
- Use extreme caution in the case of children. The unit should not be accessible to child’s play.
- **Short vacations:** Leave the refrigerator operating during vacations of less than three weeks.
- **Long vacations:** If the appliance will not be used for several months, remove all food and unplug the power cord. Clean and dry the interior thoroughly. To prevent odor and mold growth, leave the door open slightly: blocking it open if necessary or have the door removed.

Moving Your Refrigerator

- Turn the temperature control knob to “0” and then unplug the unit from the wall outlet.
- Remove all the food.
- Securely tape down all loose items inside your refrigerator.
- Tape the doors shut.
- Be sure the refrigerator stays in the upright position during transportation.

Energy Saving Tips

- The refrigerator should be located in the coolest area of the room, away from heat producing appliances or heating ducts, and out of the direct sunlight.
- Let hot foods cool to room temperature before placing in the refrigerator. Overloading the refrigerator forces the compressor to run longer. Foods that freeze too slowly may lose quality, or spoil.
- Be sure to wrap foods properly, and wipe containers dry before placing them in the refrigerator. This cuts down on frost build-up inside the refrigerator.
- Organize and label food to reduce door openings and extended searches. Remove as many items as needed at one time, and close the door as soon as possible.

TROUBLESHOOTING GUIDE

You can solve many common refrigerator problems easily, saving you the cost of a possible service call. Try the suggestions below to see if you can solve the problem before calling for service.

PROBLEM	POSSIBLE CAUSE
Refrigerator does not operate.	Not plugged in. The circuit breaker tripped or a blown fuse.
Compressor turns on and off frequently.	The room temperature is hotter than normal. A large amount of food has been added to the refrigerator. The door is opened too often. The door is not closed completely. The temperature control is not set correctly. The door gasket does not seal properly. The refrigerator does not have the correct clearances. The refrigerator has recently been disconnected for a period of time. 4 hours are required for the refrigerator to cool down completely.
Temperature inside the refrigerator is too warm.	Temperature control is set too warm. Turn the control to a cooler setting and allow several hours for the temperature to stabilize. Door is kept open too long or is opened too frequently. Warm air enters the refrigerator every time the door is opened. Open the door less often. The door is not closed completely. The door gasket does not seal properly. A large amount of warm or hot food might have been stored recently. Wait until the refrigerator has had a chance to reach its selected temperature. The refrigerator has recently been disconnected for a period of time. 4 hours are required for the refrigerator to cool down completely.
Temperature inside the refrigerator is too cold.	Temperature control is set too cold. Turn the control to a warmer setting and allow several hours for the temperature to stabilize.
Temperature of external refrigerator surface is warm.	The exterior refrigerator walls can be as much as 30°F warmer than room temperature. This is normal while the compressor works to transfer heat from inside the refrigerator cabinet.
Popping or cracking sound when compressor comes on.	Metal parts undergo expansion and contraction, as in hot water pipes. This is normal. Sound will level off or disappear as refrigerator continues to run.
Bubbling or gurgling sound, like water boiling.	Refrigerant (used to cool refrigerator) is circulating throughout the system. This is normal.
Vibrations.	Check to assure that the refrigerator is on a level surface. Floor is uneven or weak. Refrigerator rocks on the floor when it is moved slightly. Be sure floor can adequately support refrigerator. Level the refrigerator by putting wood or metal shims under

	<p>part of the refrigerator. The refrigerator is touching the wall. Re-level the refrigerator and move it from the wall. See "Installation Instructions".</p>
Moisture forms on inside refrigerator walls.	<p>Weather is hot and humid, which increases internal rate of frost build-up. This is normal. Door is slightly open. Door is kept open too long, or is opened too frequently. Open the door less often. The door is not sealed properly.</p>
Moisture forms on outside of refrigerator.	<p>Door is slightly open, causing cold air from inside the refrigerator to meet warm moist air from outside.</p>
The door will not close properly.	<p>The refrigerator is not on a level surface. The gasket is dirty.</p>



Limited Warranty

MC Appliance Corporation warrants each new Compact Refrigerator to be free from defects in material and workmanship, and agrees to remedy any such defect or to furnish a new part(s), at the company's option, for any part(s) of the unit that has failed during the warranty period. Parts and labor expenses are covered on this unit for a period of one year from the date of purchase. A copy of the dated sales receipt or invoice is required to receive warranty service, replacement or refund.

In addition, MC Appliance Corporation warrants the compressor (parts only) to be free from defects in material and workmanship for a period of five years. The consumer is responsible for all labor and transportation expenses related to the diagnosis and replacement of the compressor after the initial one-year warranty expires. In the event the unit requires replacement or refund under the terms of this warranty, the consumer is responsible for all transportation expenses to return the unit to our factory prior to receiving a replacement unit or refund. A copy of the dated sales receipt/invoice is required to receive warranty service, replacement or refund.

This warranty covers appliances in use within the contiguous United States, Alaska, Hawaii and Puerto Rico. This warranty does not cover the following:

- Damages due to shipping damage or improper installation.
- Damages due to misuse or abuse.
- Content losses due to failure of the unit.
- Inside components such as door panels, door shelves, racks, light bulbs, etc.
- Repairs performed by unauthorized service agents.
- Service calls that do not involve defects in material and workmanship such as instructions on proper use of the product or improper installation.
- Replacement or resetting of house fuses or circuit breakers.
- Failure of this product if used for other purposes than its intended purpose.
- Disposal costs for any failed unit not returned to our factory.
- Any delivery/installation costs incurred as the result of a unit that fails to perform as specified.
- Expenses for travel and transportation for product service if your appliance is located in a remote area where service by an authorized service technician is not available.
- The removal and reinstallation of your appliance if it is installed in an inaccessible location or is not installed in accordance with published installation instructions.
- Refunds for non repairable products are limited to the price paid for the unit per the sales receipt.
- This warranty is non transferable. This warranty applies only to the original purchaser and does not extend to any subsequent owner(s).

Limitations of Remedies and Exclusions:

Product repair in accordance with the terms herein, is your sole and exclusive remedy under this limited warranty. Any and all implied warranties including merchantability and fitness for a particular purpose are hereby limited to one year or the shortest period allowed by law. MC Appliance Corporation is not liable for incidental or consequential damages and no representative or person is authorized to assume for us any other liability in connection with the sale of this product. Under no circumstances is the consumer permitted to return this unit to the factory without the prior written consent of MC Appliance Corporation.

Some states prohibit the exclusion or limitation of incidental or consequential damages, or limitations on implied warranties. This warranty gives you specific legal rights, and you may also have other rights which vary from state to state.

Model	Parts & Labor	Compressor (Parts Only)	Type of Service
HMBR440WE	One Year	Five Years	Carry In
HMBR440BE	One Year	Five Years	Carry In
HMBR440SE	One Year	Five Years	Carry In

For Service or Assistance please call **888-775-0202** or visit us on the web at **www.mcappliance.com** to request warranty service or order parts.



**CNA International, Inc. d/b/a MC Appliance Corporation. All rights reserved.
Magic Chef® logo is a registered trademark of CNA International, Inc.**

www.mcappliance.com

Printed in China