

This Owner's Manual is provided and hosted by [Appliance Factory Parts](#).



MAGIC CHEF EW13F1ST Owner's Manual

[Shop genuine replacement parts for MAGIC CHEF
EW13F1ST](#)



[Find Your MAGIC CHEF Microwave Parts - Select From 180 Models](#)

----- Manual continues below -----



1.3 cu.ft. Full Stainless Steel Microwave Oven

EW13F1ST

Operation Instructions
and Cooking Guide

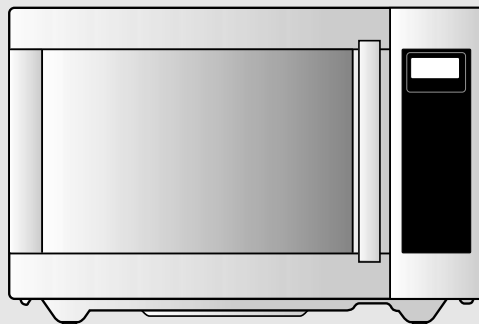

Before operating this oven, please read these instructions completely.

PRECAUTIONS TO AVOID POSSIBLE EXPOSURE TO EXCESSIVE MICROWAVE ENERGY

- (a) Do not attempt to operate this oven with the door open since open-door operation can result in harmful exposure to microwave energy. It is important not to defeat or tamper with the safety interlocks.
- (b) Do not place any object between the oven front face and the door or allow soil or cleaner residue to accumulate on sealing surfaces.
- (c) Do not operate the oven if it is damaged.
It is particularly important that the oven door close properly and that there is no damage to the: (1) door (bent), (2) hinges and latches (broken or loosened), (3) door seals and sealing surfaces.
- (d) The oven should not be adjusted or repaired by anyone except properly qualified service personnel.

TABLE OF CONTENTS

PRECAUTIONS	1
IMPORTANT SAFETY INSTRUCTIONS	2
FEDERAL COMMUNICATIONS COMMISSION RADIO FREQUENCY INTERFERENCE STATEMENT (U.S.A ONLY)	3
GROUNDING INSTRUCTIONS	3
INSTALLATION	4
SPECIFICATIONS	5
FEATURES DIAGRAM	6
OPERATION PROCEDURE	8
CONTROLS	9
SETTING THE CLOCK	9
TIME DEFROSTING	9
WEIGHT DEFROSTING	10
COOKING IN ONE STAGE	11
COOKING IN TWO STAGES	11
KITCHEN TIMER MODE	12
SPEEDY COOK	13
ONE TOUCH COOKING	13
LESS, MORE	15
CHILD SAFETY LOCK	15
TO STOP THE OVEN WHILE THE OVEN IS OPERATING	15
UTENSIL TEST	16
COOKING UTENSILS	16
COOKING TECHNIQUES	17
DEFROSTING GUIDE	18
DEFROSTING CHART	19
COOKING CHART	20
REHEATING CHART	21
CARE OF YOUR MICROWAVE OVEN	23
USE YOUR MICROWAVE OVEN SAFELY	24
QUESTIONS AND ANSWERS	25
WEIGHT & MEASURE CONVERSION CHART	26
BEFORE YOU CALL FOR SERVICE	26

IMPORTANT SAFETY INSTRUCTIONS

When using electrical appliances, basic safety precautions should be followed, including the following:

WARNING-To reduce the risk of burns, electric shock, fire, injury to persons or exposure to excessive microwave energy:

1. Read all instructions before using the appliance.
2. Read and follow the specific "PRECAUTIONS TO AVOID POSSIBLE EXPOSURE TO EXCESSIVE MICROWAVE ENERGY" found on page 1.
3. This appliance must be grounded. To ensure continued protection against shock hazard, connect only to properly grounded outlet. See "GROUNDING INSTRUCTIONS" found on page 3.
4. Install or locate this appliance only in accordance with the provided installation instructions.
5. Some products such as whole eggs and sealed containers - for example, closed glass jars-may explode and should not be heated in this oven.
6. Use this appliance only for its intended use as described in this manual. Do not use corrosive chemicals or vapors in this appliance. This type of oven is specifically designed to heat, cook, or dry food. It is not designed for industrial or laboratory use.
7. As with any appliance, close supervision is necessary when used by children.
8. Do not operate this appliance if it has a damaged cord or plug, if it is not working properly, or if it has been damaged or dropped.
9. This appliance should be serviced only by qualified service personnel. Contact nearest authorized service facility for examination, repair or adjustment.
10. Do not cover or block any openings on the appliance.
11. Do not store this appliance outdoors. Do not use this product near water — for example, near a kitchen sink, in a wet basement, or near a swimming pool, and the like.
12. Do not immerse cord or plug in water.
13. Keep cord away from heated surfaces.
14. Do not let cord hang over edge of table or counter.
15. Either:
 - a) When cleaning surfaces of door and oven that comes together on closing the door, use only mild, non-abrasive soaps or detergents applied with a sponge or soft cloth , or
 - b) When separate cleaning instructions are provided, See door surface cleaning instructions on (page.23).
16. To reduce the risk of fire in the oven cavity:
 - a) Do not overcook food. Carefully attend appliance if paper, plastic, or other combustible materials are placed inside the oven to facilitate cooking.
 - b) Remove wire twist-ties from paper or plastic bags before placing bag in oven.
 - c) If materials inside the oven should ignite, keep oven door closed, turn oven off, and disconnect the power cord, or shut off power at the fuse or circuit breaker panel.
 - d) Do not use the cavity for storage purposes. Do not leave paper products, cooking utensils, or food in the cavity when not in use.
17. Do not use this microwave oven to heat corrosive chemicals (for example, sulfides and chlorides). Vapours from such corrosive chemicals may interact with the contact and springs of the safety interlock switches thereby rendering them inoperable.
18. Keep the waveguide cover clean at all times. Wipe the oven interior with a soft damp cloth after each use. If you leave grease or fat anywhere in the cavity it may overheat, smoke or even catch fire when next using the oven.
19. Never heat oil or fat for deep frying as you cannot control the temperature and doing so may lead to overheating and fire.

SAVE THESE INSTRUCTIONS

FEDERAL COMMUNICATIONS COMMISSION RADIO FREQUENCY INTERFERENCE STATEMENT (U.S.A ONLY)

WARNING:

This equipment generates and uses ISM frequency energy and if not installed and used properly, that is in strict accordance with the manufacturer's instructions, may cause interference to radio and television reception.

It has been type-tested and found to comply with limits for an ISM equipment pursuant to part 18 of FCC rules, which are designed to provide reasonable protection against such interference in a residential installation.

However, there is no guarantee that interference will not occur in a particular installation.

If this equipment does cause interference to radio or television reception, which can be determined by turning the equipment off and on, the user is encouraged to try correct the interference by one or more of the followings.

- Reorient the receiving antenna of radio or television.
- Relocate the microwave oven with respect to the receiver.
- Move the microwave oven away from the receiver.
- Plug the microwave oven into a different outlet so that microwave oven and receiver are on different branch circuits.

THE MANUFACTURER is not responsible for any radio or TV interference caused by UNAUTHORIZED MODIFICATION to this microwave oven. It is the responsibility of the user to correct such interference.

GROUNDING INSTRUCTIONS

This appliance must be grounded. In the event of an electrical short circuit, grounding plug reduces the risk of electric shock by providing an escape wire for electric current. This appliance is equipped with a cord having a grounding wire with a grounding plug. The plug must be plugged into an outlet that is properly installed and grounded.

WARNING: Improper use of the grounding can result in a risk of electric shock.

Consult a qualified electrician or serviceman if the grounding instructions are not completely understood, or if doubt exists as to whether the appliance is properly grounded, and either:

- (1) If it is necessary to use an extension cord, use only a 3-wire extension cord that has a 3-blade grounding plug, and a 3-slot receptacle that will accept the plug on the appliance. The marked rating of the extension cord shall be equal to or greater than the electrical rating of the appliance, or
- (2) Do not use an extension cord, if the power supply cord is too short, have a qualified electrician or serviceman install an outlet near the appliance.

INSTALLATION

1 Examine the oven after unpacking.

Check for damage such as a misaligned door, broken door or dent in the cavity. If any damage is visible, **DO NOT INSTALL**, and notify your dealer immediately.

2 Level, flat location.

Install the microwave oven on a level, flat surface.

3 Ventilation

Do not block air vents. If they are blocked during operation, the oven may overheat and eventually cause a failure. For proper ventilation, allow 4 inches of space between oven top, sides, rear and adjacent surfaces.

4 Away from radio and TV sets

Poor television reception and radio interference may result if the oven is located close to a TV, radio, antenna, feeder, etc. Place the oven as far from them as possible.

5 Away from heating appliances and water taps

Keep the oven away from heat, steam or splashing liquids. These things can adversely affect oven wiring and contacts.

6 Power supply

This microwave oven requires a power supply of approximately 15 Amperes, 120 Volts, 60 Hz and a grounded outlet. A short power cord is provided to reduce the risk of the user becoming entangled in or tripping over a longer cord. Longer cord sets or extension cords are available and may be used if care is exercised in their use.

If an extension cord is used, the marked electrical rating of the cord should be at least as great as the electrical rating of the oven in their use.

The Extension cord must be a grounding-type 3-wire cord. The longer cord should be arranged so that it will not drape over the counter top or tabletop where it can be pulled on by children or tripped over unintentionally.

7 The minimum height of free space necessary above the top surface of the oven is 100mm.

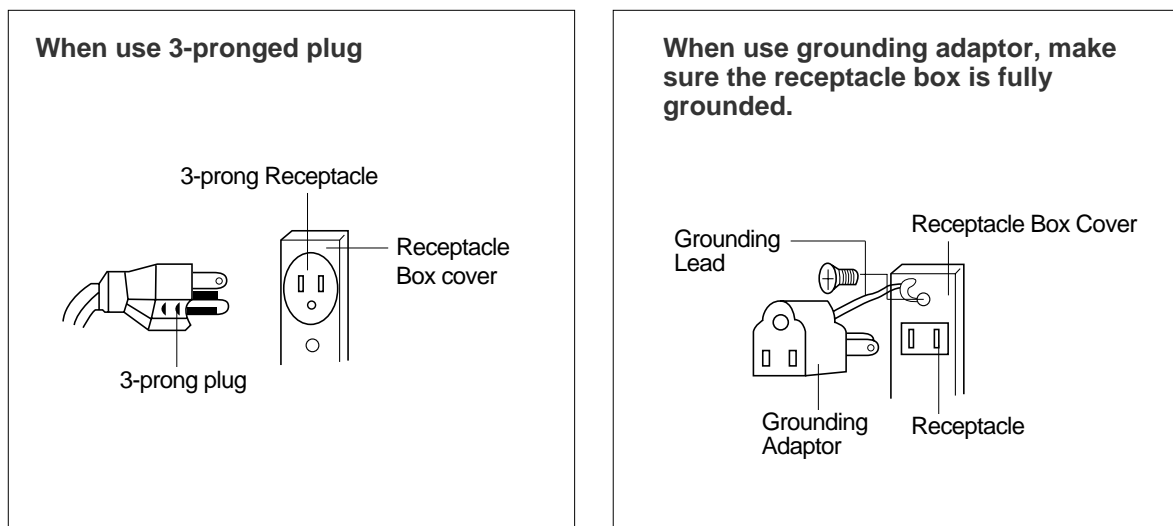

"THE CANADIAN ELECTRICAL CODE DOES NOT ALLOW THE USE OF THE GROUNDING ADAPTOR"

SPECIFICATIONS

POWER SUPPLY		120V AC 60 Hz SINGLE PHASE WITH GROUNDING
MICROWAVE	POWER CONSUMPTION	1500 W
	OUTPUT POWER	1100 W
	FREQUENCY	2450 MHz
OUTSIDE DIMENSIONS (W X H X D)		560 x 344 x 471 mm (22 x 13.5 x 18.5 in.)
CAVITY DIMENSIONS (W X H X D)		369 x 246 x 394 mm (14.5 x 9.7 x 15.5 in.)
NET WEIGHT		APPROX. 16.7 kG (36.8 lbs.)
TIMER		99 min. 99 sec.
POWER LEVELS		10 LEVELS

** Specifications are subject to change without notice.*

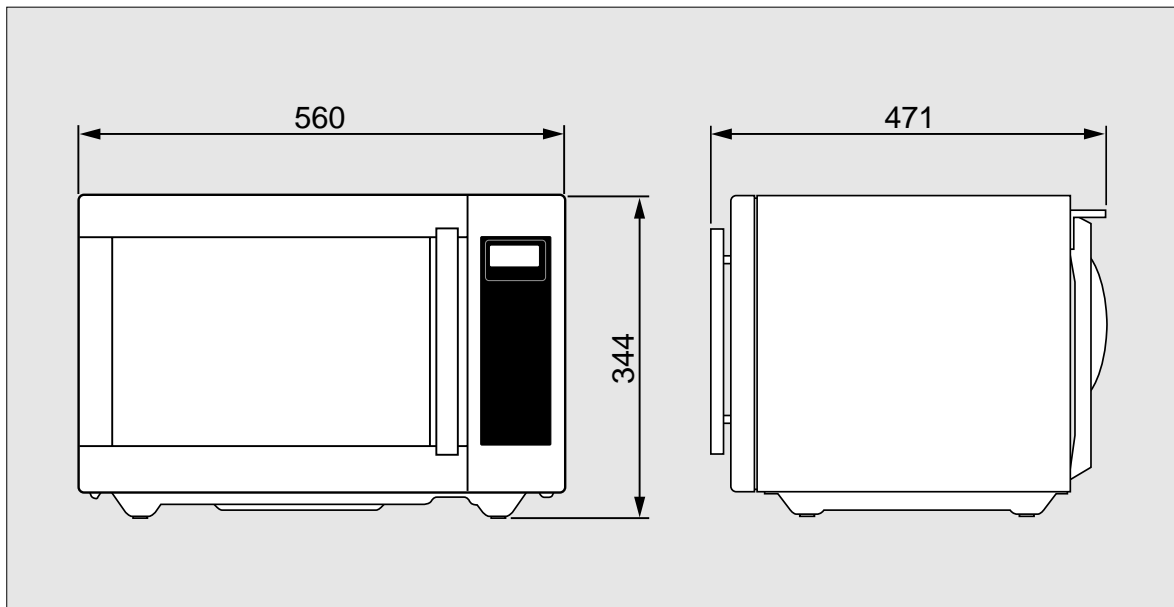

FEATURES DIAGRAM

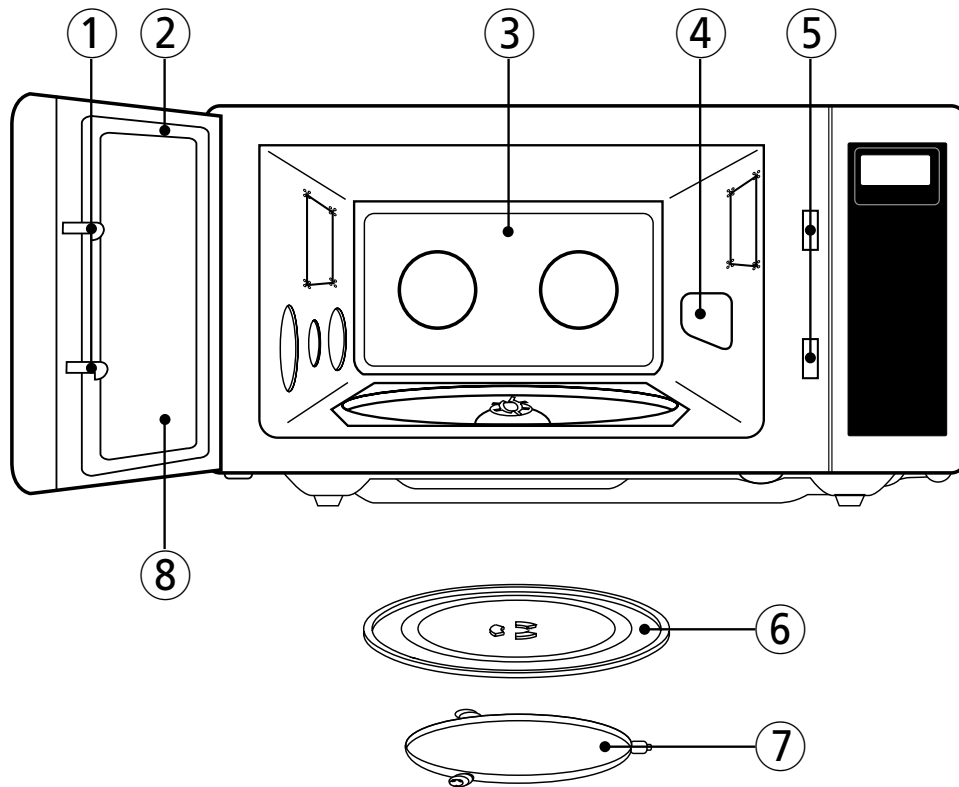

- ① **Door latch** - When the door is closed it will automatically lock shut. If the door is opened while the oven is operating, the magnetron will automatically shut off.
- ② **Door seal** - The door seal maintains the microwave within the oven cavity and prevents microwave leakage.
- ③ **Oven cavity**
- ④ **Spatter shield** - Protects the microwave outlet from splashes of cooking foods.
- ⑤ **Safety interlock system** - Prevents the oven from operating while the door is opened.
- ⑥ **Glass cooking tray** - Made of special heat resistant glass. The tray must always be in proper position before operating.
- ⑦ **Roller guide** - Supports the glass cooking tray.
- ⑧ **Door screen** - Allows viewing of food. The screen is designed so that light can pass through, but not the microwaves.

FEATURES DIAGRAM (continued)

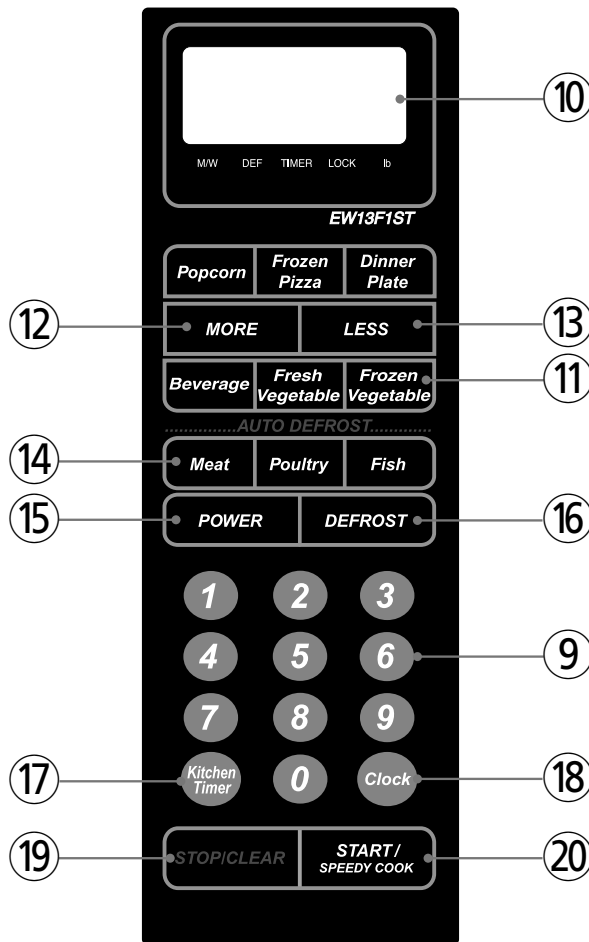

- ⑨ **TIME SET PAD** - Used to set the cooking time and the present time.
- ⑩ **DISPLAY** - Cooking time, power level, indicators and present time are displayed.
- ⑪ **ONE TOUCH** - Used to cook or reheat specific quantities of food.
- ⑫ **MORE** - Used to add time to cooking.
- ⑬ **LESS** - Used to remove time from cooking.
- ⑭ **AUTO DEFROST** - Used to defrost foods.(for weight)
- ⑮ **POWER** - Used to set power level.
- ⑯ **DEFROST** - Used to defrost foods.(for time)
- ⑰ **KITCHEN TIMER** - Used as a minute timer, delay cooking, hold setting after cooking.
- ⑱ **CLOCK** - Used to set clock.
- ⑲ **STOP/CLEAR** - Used to stop the oven operation or to delete the cooking data.
- ⑳ **START /SPEEDY COOK**- Used to start the oven and also used to set a reheat time.

OPERATION PROCEDURE

This section includes useful information about oven operation.

1. Plug power supply cord into a standard 3- pronged 15 Amp, 120V AC 60Hz power outlet.
2. After placing the food in a suitable container, open the oven door and put it on the glass tray.
The glass tray and roller guide must always be in place during cooking.
3. Shut the door. Make sure that it is firmly closed.

1 The oven light is on when the microwave oven is operating or the door is opened.

2 The oven door can be opened at any time during operation by opening the door. The oven will automatically shut off.

3 Each time a pad is touched, a BEEP will sound to acknowledge the touch.

4 The oven automatically cooks on full power unless set to a lower power level.

5 The display will show ":0" when the oven is plugged in.

6 Time clock returns to the present time when the cooking time ends.

7 When the STOP/CLEAR pad is touched during the oven operation, the oven stops cooking and all information retained.

To erase all information (except the present time), touch the STOP/CLEAR pad once more. If the oven door is opened during the oven operation, all information is retained.

8 If the START pad is touched and the oven does not operate, check the area between the door and door seal for obstructions and make sure the door is closed securely. The oven will not start cooking until the door is completely closed or the program has been reset.

Make sure the oven is properly installed and plugged into the electrical outlet.

WATTAGE OUTPUT CHART

- The power-level is set by touching the POWER pad. The chart shows the display, the power level and the percentage of power.

Touch POWER pad	Power Level (Display)	Approximate Percentage of Power
once	P-HI	100%
twice	P-90	90%
3 times	P-80	80%
4 times	P-70	70%
5 times	P-60	60%
6 times	P-50	50%
7 times	P-40	40%
8 times	P-30	30%
9 times	P-20	20%
10 times	P-10	10%
11 times	P-00	0%

CONTROLS

SETTING THE CLOCK

When the oven is first plugged in, the display will flash ":0" and a tone will sound. If the AC power ever goes off, the display shows ":0" when the power comes back on.

CLOCK

1. Touch CLOCK pad.
This is a 12 hour clock system.
2. Touch CLOCK pad once more.
This is a 24hour clock system.
3. Enter the correct time of day by touching the numbers in sequence.
4. Touch CLOCK pad.
5. Touch STOP/CLEAR pad.

NOTE: This oven has multiple clock system. If you want 12 hour clock system, omit this step.

The display stops blinking, and the colon start blinking. If you selected 12 hour clock system, this digital clock allows you to set from 1:00 to 12:59. If you selected 24 hour clock system, this digital clock allows you to set from 0:00 to 23:59.

NOTE: If you attempt to enter an incorrect time, the time will not be set and a error signal tone will sound. Touch the CLOCK pad and re-enter the time.

TIME DEFROSTING

When DEFROST is selected, the automatic cycle divides the defrosting time into periods of alternating defrost and stand times by cycling on and off.

DEFROST

1. Touch DEFROST pad.
The DEFROST indicator lights and " : 0" is displayed.
2. Touch number pads for the desired defrosting time.
The display will show the numbers you pressed in the order you touched.
3. Touch START pad.

NOTE: Your oven can be programmed for 99 minutes 99 seconds.(99:99)

When you touch START pad, the DEF indicator starts blinking to show the oven is in the DEFROST mode. The display counts down the time to show you how much defrosting time is left in the DEFROST mode. The oven beeps during the defrosting cycle to signal that the food needs to be turned or rearranged. When the defrosting time ends, you will hear 3 beeps.

WEIGHT DEFROSTING

WEIGHT DEFROSTING lets you easily defrost food by eliminating guesswork in determining defrosting time. Follow the steps below for easy defrosting.

MEAT	1. Touch MEAT pad.	The lb indicator light and "1.0" is displayed.
	2. Select desired defrosting weight.	The display will show what you touched.
	3. Touch START pad.	MEAT DEFROSTING begins.
POULTRY	1. Touch POULTRY pad.	The lb indicator light and "1.5" is displayed.
	2. Select desired defrosting weight.	The display will show what you touched.
	3. Touch START pad.	POULTRY DEFROSTING begins.
FISH	1. Touch FISH pad.	The lb indicator light and "0.5" is displayed.
	2. Select desired defrosting weight.	The display will show what you touched.
	3. Touch START pad.	FISH DEFROSTING begins.

* WEIGHT DEFROST CHART

Touch pad	MEAT	POULTRY	FISH
once	1.0 lb	1.5 lb	0.5 lb
twice	1.5 lb	2.0 lb	1.0 lb
3 times	2.0 lb	2.5 lb	1.5 lb
4 times	2.5 lb	3.0 lb	2.0 lb

The defrosting time is automatically determined by the weight selected. The lb indicator goes off and the DEF indicator blinks and the defrosting time counts down in the display window. The oven beeps during the defrosting cycle to signal that the food needs to be turned or rearranged. When the defrosting time ends, you will hear 3 beeps.

COOKING IN ONE STAGE

POWER	x6	1. Touch POWER pad. (Select desired power level.)	The M/W indicator lights. The display will show what you touched.
2. Touch the number pads for the cooking time.			<p>NOTE: If steps 1 is omitted, the oven will cook at full power.</p>
3. Touch START pad.			<p>NOTE: Your oven can be programmed for 99 minutes 99 seconds. (99:99)</p>

When you touch START pad, the M/W indicator starts blinking to show the oven is cooking. The display counts down the time to show how much cooking time is left. When the cooking time ends, you will hear 3 beeps.

NOTE: Using lower power levels increases the cooking time which is recommended for foods such as cheese, milk and slow cooking of meats.

COOKING IN TWO STAGES

All recipes require frozen foods to be defrosted fully before cooking. This oven can be programmed to automatically defrost foods before cooking.

DEFROST	1. Touch DEFROST pad.	The DEF indicator lights and “ : 0” is displayed.
	2. Touch number pads for the defrosting time you want.	The display will show the numbers you pressed in the order you touched.
POWER	x6	3. Touch POWER pad. (Select desired power level.)
	4. Touch number pads for desired cooking time.	The M/W indicator lights and “ P-50” is The display will show what you touched. This example shows power level 5.
	5. Touch START pad.	The display will show the number you pressed in the order you touched.

When you touch START pad, the DEF and M/W indicators come on to confirm the power levels selected. The DEF indicator starts blinking to show you that the oven is in DEFROST mode. The display counts down the time remaining in DEFROST mode. When the oven beeps, turn over, break apart and/or redistribute the food. At the end of DEFROST mode, the oven will beep and start M/W cook. The DEF indicator goes off and the M/W indicator starts blinking. The display counts down the time remaining in M/W cook. When M/W cook ends, you will hear 3 beeps.

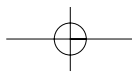

KITCHEN TIMER MODE

Timer operates as a minute timer, can be set to delay cooking and used as a hold setting after cooking. However delay cooking can not be programmed for defrost. Timer operates without microwave energy.

HOW TO USE AS A MINUTE TIMER

KITCHEN TIMER	1. Touch KITCHEN TIMER pad.	The TIMER indicator lights and “ : 0 ” is displayed.
	2. Press the amount of time you want to count down.	The display will show the numbers you pressed in the order you touched.
	3. Touch START pad.	The display counts down the time remaining in KITCHEN TIMER mode. When KITCHEN TIMER mode ends, you will hear 3 beeps.

HOW TO USE TO DELAY THE START OF COOKING

KITCHEN TIMER	1. Touch KITCHEN TIMER pad.	The TIMER indicator lights and “ : 0 ” is displayed.
	2. Press the amount of time you want to delay time.	The display will show the numbers you pressed in the order you touched.
	3. Program the desired power level and cooking time for food to be cooked.	The M/W indicator lights and the selected power level & cooking time are displayed.
	4. Touch START pad.	The kitchen timer will begin counting down to zero and cooking will then begin.

HOW TO USE TO SET A HOLDING TIME

KITCHEN TIMER	1. Program the desired cooking time.	The M/W indicator lights and “ : 0 ” is displayed.
	2. Touch KITCHEN TIMER pad.	The TIMER indicator lights and “ : 0 ” is displayed.
	3. Press the amount of time you want the oven to hold.	The display will show the numbers you pressed in the order you touched.
	4. Touch START pad.	Cooking will start. After cooking, stand time will count down.

NOTE: Your oven can be programmed for 99 minutes 99 seconds. (99:99)

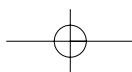

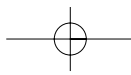

SPEEDY COOK

SPEEDY COOK allows you to reheat for 30 seconds at 100% (full power) by simply touching the SPEEDY COOK pad.

By repeatedly touching the SPEEDY COOK pad, you can also extend reheating time to 5 minutes by 30 second increments.

SPEEDY COOK

1. Touch SPEEDY COOK pad.

When you touch SPEEDY COOK, ":30" is displayed.

After 1.5 seconds, the oven starts reheating.

ONE TOUCH COOKING

One touch cook allows you to cook or reheat many of your favorite foods by touching just one pad. To increase quantity, touch chosen pad until number in display is same as desired quantity to cook. (except for POPCORN)

POPCORN

1. Remove plastic wrap. Follow manufacture's directions for placement and care in opening.
2. Touch POPCORN pad once for a 3.5 oz bag .

When you touch POPCORN pad once, "3.5" is displayed.

After the 1.5 seconds, the display shows the cooking time and the oven starts cooking.

- NOTE:**
1. Use prepackaged room-temperature microwave popcorn.
 2. Place bag in oven according to manufacturer's directions.
 3. Pop only one bag at a time.
 4. After popping, open bag carefully: popcorn and steam are extremely hot.
 5. Do not reheat unpopped kernels or reuse bag.
 6. Do not leave oven unattended while popping popcorn.

CAUTION : If prepackaged popcorn is of a different weight than the recommended weight, do not use the POPCORN pad. Follow the manufacturer instruction.

FROZEN PIZZA

1. Follow package directions for preparation model.
2. Touch FROZEN PIZZA pad once for 7 oz pizza or twice for 14 oz pizza.

When you touch FROZEN PIZZA pad once, "7" is displayed.

After 1.5 seconds, the display shows the cooking time and the oven starts cooking.

* FROZEN PIZZA *

- 7 oz : Touch FROZEN PIZZA once.
- 14 oz : Touch FROZEN PIZZA twice within 1.5 seconds.

- NOTE:**
1. Use only frozen pizza at a time.
 2. Use only frozen pizza made for microwave ovens.
 3. If the cheese of frozen pizza does not melt sufficiently, cook a few seconds longer.
 4. Some brands of frozen pizza may required more or less cooking time.

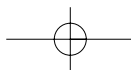

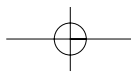

ONE TOUCH COOKING (CONTINUED)

BEVERAGE

1. Pour beverage in microwave mug. Place it on the turntable. Do not cover. Stir before serving.
2. Touch BEVERAGE pad once for 1 cup, twice for 2 cups or three times for 3 cups.

When you touch BEVERAGE pad once, "1" is displayed.
After 1.5 seconds, the display changes into cooking time of quantity and the oven starts cooking.

* BEVERAGE * (200ml/cup)

- 1 cup(mug) : Touch BEVERAGE once.
- 2 cups(mugs) : Touch BEVERAGE twice within 1.5 seconds.
- 3 cups(mugs) : Touch BEVERAGE three times within 1.5 seconds.

DINNER PLATE

1. Put foods in the microwave plate. Cover with vented plastic wrap.
2. Touch DINNER PLATE pad once for 12 oz dinner plate or twice for 15 oz of dinner plate.

When you touch DINNER PLATE pad once, "12" is displayed.
After 1.5 seconds, the display shows the cooking time and the oven starts cooking.

* DINNER PLATE *

- 12 oz : Touch DINNER PLATE once.
- 15 oz : Touch DINNER PLATE twice within 1.5 seconds.

FRESH VEGETABLE

1. Trim and wash the mixed vegetables. Place them in the round dish. Add to 2 Tbsp. water.
2. Touch FRESH VEGETABLE pad once for 7 oz of fresh vegetable or twice for 14 oz of fresh vegetable.

When you touch FRESH VEGETABLE pad once, "7" is displayed.
After 1.5 seconds, the display shows cooking time and the oven starts cooking.

* FRESH VEGETABLE *

- 7 oz : Touch FRESH VEGETABLE once.
- 14 oz : Touch FRESH VEGETABLE twice within 1.5 seconds.

FROZEN VEGETABLE

1. Place the vegetables in the round dish. Add to 2 Tbsp. water.
2. Touch FROZEN VEGETABLE pad once for 7 oz of frozen vegetable or twice for 14 oz of frozen vegetable.

When you touch FROZEN VEGETABLE pad once, "7" is displayed.
After 1.5 seconds, the display shows cooking time and the oven starts cooking.

* FROZEN VEGETABLE *

- 7 oz : Touch FROZEN VEGETABLE once.
- 14 oz : Touch FROZEN VEGETABLE twice within 1.5 seconds.

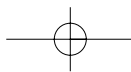

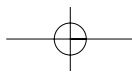

LESS, MORE

To alter one touch cooking or cooking time whilst oven is in operation, use LESS or MORE. (except for defrosting) Press LESS/MORE to decrease/increase the one touch cooking time in multiples of 10 seconds.

The overall one touch cooking time can be increased to a maximum of 99 minutes 50 seconds.

Press LESS/MORE to decrease/increase the cooking time in multiples of 1 minute.

The overall cooking time can be increased to a maximum of 99 minutes.

CHILD SAFETY LOCK

The safety lock prevents unwanted oven operation such as by small children.

To set, press and hold STOP/CLEAR for 3 seconds, LOCK indicator lights.

To cancel, press and hold STOP/CLEAR for 3 seconds, LOCK indicator goes off.

TO STOP THE OVEN WHILE THE OVEN IS OPERATING

1. Press STOP/CLEAR pad.
 - You can restart the oven by touching START pad.
 - Touch STOP/CLEAR once more to erase all instructions.
 - You must enter in new instructions.
2. Open the door.
 - You can restart the oven by closing the door and touching START.

NOTE: Oven stops operating when door is opened.

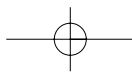

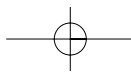

UTENSIL TEST	<p>Dishes that do not absorb microwave energy are best for microwave cooking. Lock on the label to verify that particular cups, glasses, plates are indeed suitable, especially paper goods. If you are not sure, try this utensil test to check.</p> <ul style="list-style-type: none"> • Put the empty utensil in the microwave oven. • Put one cup of water in a glass measure next to the empty utensil. • Heat on P-HI for 1 minute. • After 1 minute the water should be warm but the utensil should not. If the utensil is warm, it is not suitable for microwave cooking.
---------------------	---

COOKING UTENSILS

Recommended Use

- glass and glass-ceramic bowls and dishes - Use for heating or cooking.
- Microwave browning dish - Use to brown the exterior of small items such as steaks, chops, or pancakes. follow the directions provided with you browning dish.
- Microwaveable plastic wrap - Use to retain steam. Leave a small opening for some steam to escape and avoid placing it directly on the food.
- Wax paper - Use as a cover to prevent spattering.
- Paper towels and napkins - Use for short term heating and covering; they absorb excess moisture and prevent spattering. Do not use recycled paper towels, which may contain metal and can catch fire.
- Thermometers - Use only those labeled "Microwave Safe" and follow all directions. Check the food in several places. Conventional thermometers may be used once the food has been removed from the oven.

Limited Use

- Aluminum foil - Use narrow strips of foil to prevent overcooking of exposed areas. Using too much foil can damage your oven, so be careful.
- Ceramic, porcelain, and stoneware - use these if they are labeled "Microwave Safe." If they are not labeled, test them to make sure they can be used safely. Never use dishes with metallic trim.
- Plastic - Use only if labeled "Microwave Safe." Other plastics can melt.
- Straw, wicker, and wood - Use only for short-term heating, as they can be flammable.

Not Recommended

- Glass jars and bottles - Regular glass is too thin to be used in a microwave, and can shatter.
- Paper bags - These are a fire hazard, except for popcorn bags that are designed for microwave use.
- Styrofoam plates and cups - These can melt and leave an unhealthy residue on food.
- Plastic storage and food containers - Containers such as margarine tubs can melt in the microwave.
- Metal utensils - These can damage your oven. Remove all metal before cooking.

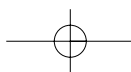

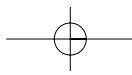

COOKING TECHNIQUES

Stirring

Stir foods such as casseroles and vegetables while cooking to distribute heat evenly.

Food at the outside of the dish absorbs more energy and heats more quickly, so stir from the outside to the center. The oven will turn off when you open the door to stir your food.

Arrangement

arrange unevenly shaped foods, such as chicken pieces or chops, with the thicker, meatier parts toward the outside of the turntable where they receive more microwave energy. To prevent overcooking, place thin or delicate parts toward the center of the turntable.

Shielding

Shield food with narrow strips of aluminum foil to prevent overcooking. Areas that need shielding include poultry wing-tips, the ends of poultry legs, and corners of square baking dishes. Use only small amounts of aluminum foil. Larger amounts can damage your oven.

turning

Turning

Turn foods oven midway through cooking to expose all parts to microwave energy. This is especially important with large items such as roasts.

Standing

Standing

Foods cooked in the microwave build up internal heat and continue to cook for a few minutes after the oven stops. Let foods stand to complete cooking, especially foods such as roasts and whole vegetables. Roasts need this time to complete cooking in the center without overcooking the outer areas. All liquids, such as soup or hot chocolate, should be shaken or stirred when cooking is complete. Let liquids stand a moment before serving. When heating baby food, stir well and test the temperature before serving.

Adding Moisture

Microwave energy is attracted to water molecules. Food that is uneven in moisture content should be covered or allowed to stand so that the heat disperses evenly. Add a small amount of water to dry food to help it cook.

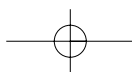

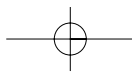

DEFROSTING GUIDE

GENERAL INFORMATION

- ⇒ Put the food on a microwave rack (roasts, bone-in pieces) or in a microwave casserole (small pieces such as cubes or strips) or weigh at home on a kitchen scale. Round number to the nearest tenth of a pound and choose that number with each item pads.
- ⇒ The shape of food items, especially larger ones, will vary affect the way defrost. Always check the status after the standing time. Fish, seafood and poultry should still be somewhat icy in the center the held under cold running water to finish defrosting. If more time is needed, use DEFROST by time to add time in small increments.
- ⇒ Halfway through the defrosting process, a series of beeps will indicate that it is time to change the position of the item being defrosted. The includes turning over or rotating the item, separating defrosted pieces or sections, or shielding.
- ⇒ Shielding means to use a 2-inch strip of aluminum foil to protect thinner or unevenly shaped part from beginning to cook. Microwave energy will not penetrate the foil. Some rules apply to the use of foil:
Do not let the foil pieces touch each other or the sides of the microwave oven.
Be sure that all ends are touched under and lie flat to the food.
Remember to adjust foil when a item is turned over and cover with wax paper.
- ⇒ To prepare food for freezer storage(and later defrosting), wrap tightly in moisture proof packaging. If using freezer plastic bags, be sure to let all the air out to prevent freezer bump on the food. Package so that food is as evenly shaped as possible ease in defrosting

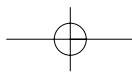
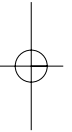
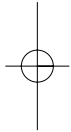

DEFROSTING CHART

Item and Weight	Defrosting Time	Standing Time	Special Techniques
BEEF Mined beef 454g (1 lb.)	7-9 min.	5-7 min.	Break apart and remove thawed portions with fork.
Stew Meat 681 (1 ¹ / ₂ lbs.)	8-10 min.	5-7 min.	Separate and rearrange once.
Loin Roast 907g (2 lbs.)	12-15 min.	7-10 min.	Turn over after half the time. Shield as needed.
Patties 4 (113g (4 oz.))	5-6 min.	5-7 min.	Turn over after half the time.
PORK Loin Roast 907g (2 lbs.)	12-14 min.	7-10 min.	Turn over after half the time. Shield as needed.
Spareibs 454g (1 lb.)	5-6 min.	5-7 min.	Separate and rearrange once.
Chops 4 (142g (5 oz.))	5-7 min.	5-7 min.	Separate and turn over once.
Minced 454g (1 lb.)	6-8 min.	5-7 min.	Break apart and remove thawed portions with fork.
POULTRY Whole Chicken 1134g (2 ¹ / ₂ lbs.)	16-18 min.	10-15 min.	Breat side down. Turn over after half the time. Shield as needed.
Chicken Breasts 454g (1 lb.)	6-8 min.	5-7 min.	Separate and rearrange once.
Fryer Chicken (cut up) 907g (2 lbs.)	9-11 min.	7-10 min.	Separate and rearrange once.
Chicken Thighs 681g (1 ¹ / ₂ lbs.)	8-12 min.	5-7 min.	Separate and rearrange once.
FISH & SEAFOOD Whole Fish 454g (1 lb.)	4-5 min.	5-7 min.	Turn over after half the time. Shield as needed.
Fish Fillets 681g (1 ¹ / ₂ lb.)	5-7 min.	5-7 min.	Separate and turn over once.
Shrimp 227g (1/2 lb.)	2-3 min.	5-7 min.	Separate and rearrange once.

* The times are approximate because freezer temperatures vary.

COOKING CHART

MEAT		
ITEM	POWER LEVEL	COOKING TIMER PER POUND
Beef		
Standing/rolled Rib - Rare	P-80	7-9 min.
- Medium	P-80	8-10 min.
- well done	P-80	10-12 min.
Ground Beef(to brown for casserole)	P-HI	4-6 min.
Hamburgers, Fresh or defrosted (4 oz. Each)		
2 patties	P-HI	2-4 min.
4 patties	P-HI	3-5 min.
Pork		
Loin, Leg	P-80	10-12 min.
Bacon		
4 slices	P-HI	1-2 min.
6 slices	P-HI	2-3 min.

NOTE: The above times should be regarded only as a guide. Allow for difference in individual tastes and preferences. The times may vary due to the shape, cut, and composition of the meat.

POULTRY		
ITEM	POWER LEVEL	COOKING TIMER PER POUND
Chicken		
Whole	P-HI	6-8 min.
Breast(boned)	P-80	5-7 min.
portions	P-80	6-8 min.
Turkey		
Whole	P-HI	9-11 min.

NOTE: The above times should be regarded only as a guide. Allow for difference in individual tastes and preferences. The times may vary due to the shape and composition of the food.

FRESH FISH				
ITEM	POWER LEVEL	COOKING TIME PER POUND	METHOD	STANDING TIME
Fish Fillets	P-HI	3-5 min.	Add 15-30 ml(1-2 Tbsp)	2-3 min.
Whole Mackerel, Cleaned and Prepared	P-HI	3-5 min.	-	3-4 min.
Whole Trout, Cleaned and Prepared	P-HI	4-6 min.	-	3-4 min.
Salmon Steaks	P-HI	4-6 min.	Add 15~30 ml(1~2 Tbsp)	3-4 min.

VEGETABLE					
ITEM	POWER LEVEL	PREPARATION	QUANTITY	COOKING TIME	STANDING TIME
Artichokes, fresh	P-HI	Whole	4(8 oz. each)	6-8 min.	5 min.
Artichokes, frozen	P-HI	Hearts	250g(9 oz. pkg)	7-9 min.	5 min.

VEGETABLE					
ITEM	POWER LEVEL	PREPARATION	QUANTITY	COOKING TIME	STANDING TIME
Asparagus, fresh	P-HI	1 ¹ / ₂ -in.pieces	500g(1 lb.)	4-6 min.	3 min.
Asparagus, frozen	P-HI	Whole spears	280g(10 oz. pkg)	5-7 min.	3 min.
Broccoli, fresh	P-HI	Spears	500g(1 lb.)	4-6 min.	-
Broccoli, frozen	P-HI	Whole or cut	280g(10 oz. pkg)	5-7 min.	3 min.
Brussels sprouts, fresh	P-HI	Whole	280g(10 oz. tub)	4-6 min.	-
Brussels sprouts, frozen	P-HI	Whole	280g(10 oz. pkg)	5-7 min.	3 min.
Carrots, fresh	P-HI	1/2-in.slices	500g(1 lb.)	5-7 min.	3 min.
Carrots, frozen	P-HI	Sliced	280g(10 oz. pkg)	3-4 min.	3 min.
Cauliflower, frozen	P-HI	florets	280g(10 oz. pkg)	3-4 min.	3 min.
Celery, fresh	P-HI	1/2-in.slices	500g(1 lb.)	4-6 min.	5 min.
Corn, fresh	P-HI	on cob, husked	4 ears	6-8 min.	5 min.
Corn, frozen	P-HI	on cob, husked	4 ears	6-8 min.	5 min.
	P-HI	whole kernel	280g(10 oz. pkg)	4-6 min.	3 min.
Eggplant, fresh	P-HI	cubed	500g(1 lb.)	4-6 min.	3 min.
	P-HI	whole, pierced	500-700g(1-1 ¹ / ₂ lb.)	5-7 min.	5 min.
Leeks fresh	P-HI	whole, ends	500g(1 lb.)	5-7 min.	5 min.
Lima beans, frozen	P-HI	whole	280g(10 oz. pkg)	4-6 min.	3 min.
Mixed vegetables frozen	P-HI	-	280g(10 oz. pkg)	4-6 min.	3 min.
Mushrooms, fresh	P-HI	sliced	500g(1 lb.)	3-4 min.	3 min.
Okra, frozen	P-HI	sliced	280g(10 oz. pkg)	4-6 min.	5 min.
Onions, fresh	P-HI	whole, peeled	8-10 small	6-8 min.	5 min.
Pea pods(snow peas), frozen	P-HI	whole	170g(6 oz. pkg)	3-4 min.	3 min.
Peas and carrots	P-HI	-	280g(10 oz. pkg)	3-4 min.	3 min.
Parsnips, fresh	P-HI	cubed	500g(1 lb.)	5-7 min.	5 min.
Potatoes, white or sweet, fresh	P-HI	whole	4(6 oz. each)	12-14 min.	3 min.
	P-HI	whole	8(6 oz. each)	13-15 min.	5 min.
Squash, summer, fresh	P-HI	1/2-in.slices	500g(1 lb.)	4-6 min.	3 min.
Squash, summer, frozen	P-HI	sliced	280g(10 oz. pkg)	4-6 min.	3 min.
Squash, winter, fresh	P-HI	whole, pierced	700g(1 ¹ / ₂ lbs.)	8-10 min.	5 min.
Squash, winter, frozen	P-HI	whipped	340g(12 oz. pkg)	6-8 min.	3 min.
Succotash, frozen	P-HI	-	280g(10 oz. pkg)	4-6 min.	3 min.
Turnips	P-HI	cubed	4 cups	6-8 min.	3 min.

REHEATING CHART

ITEM	QUANTITY	POWER LEVEL	COOKING TIME	SPECIAL INSTRUCTION
Appetizers (bite size)	2 servings	P-HI	2-4 min.	Heat 12 at time on paper towel lined paper plate or microwave oven roasting rack
Breakfast entrée	110-140g(4-5 oz.)	P-HI	2-4 min.	If containers is 3/4-inch deep, remove foil cover and replace foil tray in original box.
Entrée	250g(8-9 oz.)	P-HI	8-10 min.	
Regular TV-style dinner	600g(21 oz.)	P-HI	12-15 min.	For containers more then 3/4-inch deep, remove food to similar size glass container; heat, covered. If no top crust stir occasionally.
Hearty TV-style dinner	300g(11 oz.)	P-HI	6-8 min.	
	480g(17 oz.)	P-HI	8-10 min.	

ITEM	QUANTITY	POWER LEVEL	COOKING TIME	SPECIAL INSTRUCTION
Fried chicken	2 pieces	P-HI	2-4 min.	Arrange, on paper tower lined paper plate, covered with paper tower.
	4 pieces	P-HI	3-5 min.	
	6 pieces	P-HI	4-6 min.	
Fried fresh fillets	2 fillets	P-HI	2-3 min.	
	4 fillets	P-HI	3-5 min.	
Pizzas (sliced)	1	P-HI	2-4 min.	
	2	P-HI	3-5 min.	
	4	P-HI	5-7 min.	
Pouch dinners	140~160g(5-6 oz.)	P-HI	4-5 min.	Pierce pouch. Set on plate. Turn over halfway through cooking.
	280~300g(10-11 oz.)	P-HI	7-9 min.	
Bagels	2	P-60	2-3 min.	Each individually wrapped in paper toweling (for 1-2) or arrange on paper plate, cover with paper toweling.
	4	P-60	3-5 min.	
Danish	1	P-60	1-2 min.	
	2	P-60	2-3 min.	
	4(6 oz. pkg) 6(13 oz. pkg)	P-60 P-60	3-4 min. 4-5 min.	
Dinner rolls	6	P-60	2-3 min.	
Hard rolls	1(1-1 ¹ / ₄ oz.)	P-60	1-2 min.	
	2	P-60	1 ¹ / ₂ -2 ¹ / ₂ min.	
	4	P-60	2-3 min.	
Frozen Juice	170g(6 oz.)	P-HI	1-2 min.	
Concentrates	340g(12 oz.)	P-HI	2-5 min.	
Non-Dairy creamer	450g(16 oz.)	P-60	8-10 min.	
Pancake	280g(10 oz.)	P-60	4-6 min.	
Frozen vegetables	160g(6 oz.)	P-60	6-10 min.	Pierce box, set on plate. If box is foil wrapped, remove foil. If vegetables are in pouch, pierce pouch. Let stand 5 min.
	280g(10 oz.)	P-60	8-12 min.	
Cheese cake	500g(17 oz.)	P-60	4-5 min.	Remove from original container. Arrange on a serving plate. Let stand 5 minutes after cooking(to defrost). Add an additional 1-2 minutes to serve warm.
Brownies	360g(13 oz.)	P-60	2-4 min.	
Pound cake	300g(10 ³ / ₄ oz.)	P-60	1 ¹ / ₂ -3 min.	
Coffee cake	300~340g(11-12 oz.)	P-60	3-5 min.	

CARE OF YOUR MICROWAVE OVEN

1. Turn the oven off before cleaning.
2. Keep the inside of the oven clean.
When food spatters or spilled liquids adhere to oven walls, wipe with a damp cloth.
Mild detergent may be used if the oven gets very dirty. The use of harsh detergent or abrasives is not recommended.
3. The outside oven surface should be cleaned with soap and water, rinsed and dried with a soft cloth.
To prevent damage to the operating parts inside the oven, water should not be allowed to seep into the ventilation openings.
4. If the Control Panel becomes wet, clean with a soft, dry cloth. Do not use harsh detergents or abrasives on Control Panel.
5. If steam accumulates inside or around the outside of the oven door, wipe with a soft cloth. This may occur when the microwave oven is operated under high humidity conditions and in no way indicates malfunction of the unit.

6. It is occasionally necessary to remove the glass tray for cleaning. Wash the tray in warm sudsy water or in a dishwasher.

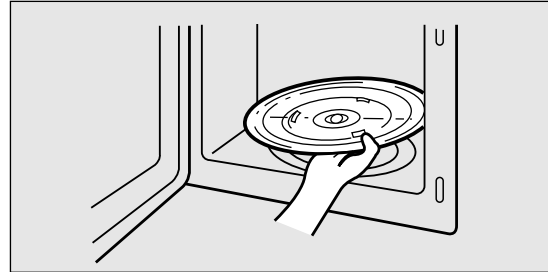

7. The roller guide and oven cavity floor should be cleaned regularly to avoid excessive noise.
Simply wipe the bottom surface of the oven with mild detergent water or window cleaner and dry. The roller guide may be washed in mild sudsy water.

ROLLER GUIDE

1. The ROLLER GUIDE and oven floor should be cleaned frequently to prevent excessive noise.
2. The ROLLER GUIDE MUST ALWAYS be used for cooking together with the Glass Tray.

GLASS TRAY

1. DO NOT operate the oven without the Glass Tray in place.
2. DO NOT use any other Glass Tray with this oven.
3. If Glass Tray is hot, ALLOW TO COOL before cleaning or placing it in water.
4. DO NOT cook directly on the Glass Tray.

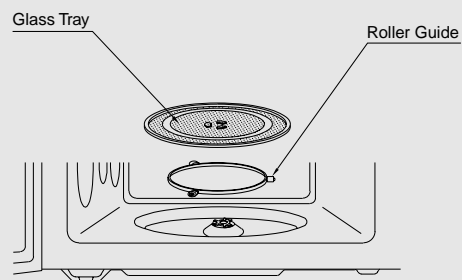

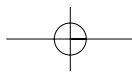

USE YOUR MICROWAVE OVEN SAFELY

General Use

Do not attempt to defeat or tamper with safety interlocks.

Do not place any object between the oven front frame and the door or allow residue to build up on sealing surfaces. Wipe with a mild detergent, rinse and dry. Never use abrasive powders or pads.

Do not subject the oven door strain or weight such as a child hanging on an open door.

This could cause the oven to fall forward resulting in injury to you and damage to the oven.

Do not operate the oven if door seals or sealing surfaces are damaged, or if door is bent, or if hinges are loose or broken.

Do not operate the oven empty. This will damage the oven.

Do not attempt to dry clothes, newspapers or other materials in the oven. They may catch on fire.

Do not use recycled paper products as they may contain impurities which may cause sparks or fires.

Do not hit or strike the control panel with hard objects. This can damage the oven.

Food

Never use your microwave oven for home canning. The oven is not designed for proper home canning.

Improperly canned food may spoil and be dangerous to consume.

Always use the minimum recipe cooking time. It is better to undercook rather than over cook foods.

Undercooked foods can be returned to the oven for more cooking. If food is overcooked, nothing can be done.

Heat small quantities of food or foods with low moisture carefully. These can quickly dry out, burn or catch on fire.

Do not heat eggs in the shell. Pressure may build up and eggs can explode.

Potatoes, apples, egg yolks and sausages are examples of food with non-porous skins.

These must be pierced before cooking to prevent bursting.

Do not attempt to deep fat fry in your microwave oven.

Always stir liquids before heating. Heated liquids can erupt, if not mixed with air.

Do not pop popcorn in a paper bag unless it is the commercially prepared Microwave Popcorn product.

The kernels can overheat and ignite a brown paper bag.

Do not exceed the Microwave Popcorn manufacturers' suggested popping time. Longer popping does not yield more popcorn but it can result in scorch burn or fire. Remember, the popcorn bag and tray can be too hot to handle. Remove with caution and use pot holders.

ARCING

*If you see arcing, press **STOP/CLEAR** pad and correct the problem.*

Arcing is the microwave term for sparks in the oven. Arcing is caused by:

- Metal or foil touching the side of the oven.
- Foil not molded to food (upturned edges act like antennas).
- Metal, such as twist-ties, poultry pins, or gold rimmed dishes, in the microwave.
- Recycled paper towels containing small metal pieces being used in the microwave.

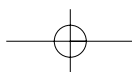

QUESTIONS AND ANSWERS

- Q : I accidentally ran my microwave oven without any food in it. Is it damaged?
A : Running the oven empty for a short time will not damage the oven.
However, it is not recommended.
- Q : Can the oven be used with the glass tray or roller guide removed?
A : No. Both the glass tray and roller guide must always be used in the oven before cooking.
- Q : Can I open the door when the oven is operating?
A : The door can be opened anytime during the cooking operation. Then microwave energy will be instantly switched off and the time setting will maintain until the door is closed and START is touched.
- Q : Why do I have moisture in my microwave oven after cooking?
A : The moisture on the side of your microwave oven is normal. It is caused by steam form cooking food heating the cool oven surface.
- Q : Dose microwave energy pass through the viewing screen in the door?
A : No. The metal screen bounces back the energy to the oven cavity. The holes are made to allow light to pass through. They do not let microwave energy pass through.
- Q : Why do eggs sometimes pop?
A : When baking or poaching eggs, the yolk may pop due to steam build-up inside the yolk membrane. To prevent this, simply pierce the yolk with a toothpick before cooking. Never cook eggs without piercing their shells.
- Q : Why is standing time recommended after the cooking operation has been completed?
A : Standing time is very important.
With microwave cooking, the heat is in the food, not in the oven. Many foods build up enough internal heat to allow the cooking process to continue, even after the food is removed from the oven. Standing time for joints of meat, large vegetables and cakes allows the inside to cook completely, without overcooking the outside.
- Q : What does "standing time" mean?
A : "Standing time" means that food should be removed from the oven and covered for additional time to allow it to finish cooking. This frees the oven for other cooking.
- Q : Why does my oven not always cook as fast as the microwave cooking guide says?
A : Check your cooking guide again, to make sure you've followed directions exactly ; and to see what might cause variations in cooking time. Cooking guide times and heat settings are suggestions, to help prevent over-cooking... the most common problem in getting used to a microwave oven. Variations in the size, shape and weights and dimensions could require longer cooking time. Use your own judgement along with the cooking guide suggestions to check whether the food has been properly cooked just as you would do with a conventional cooker.
- Q : Will the microwave oven be damaged if it operates while empty?
A : Yes. Never run it empty.
- Q : Can I operate my microwave oven without the turntable or turn the turntable over to hold a large dish?
A : No. If you remove or turn over the turntable, you will get poor cooking results. Dishes used in your oven must fit on the turntable.
- Q : Is it normal for the turntable to turn in either direction?
A : Yes. The turntable rotates clockwise or counterclockwise, depending on the rotation of the motor when the cooking cycle begins.
- Q : Can I pop popcorn in my microwave oven? How do I get the best results?
A : Yes. Pop packaged microwave popcorn following manufactures guidelines or use the preset POPCORN pad. Do not use regular paper bags. Use the "listening test" by stopping the oven as soon as the popping slows to a "pop" every 1 or 2 seconds. Do not repop unpopped kernels. Do not pop popcorn in glass cookware.

WEIGHT & MEASURE CONVERSION CHART

■ POUNDS & OUNCES TO GRAMS

POUNDS(lb.)	GRAMS(g)
1/4	114
1/2	227
3/4	341
1	454
2	907
3	1361
4	1814
5	2268
6	2722
7	3175
8	3629
9	4082
10	4526
11	4990

OUNCES(oz.)	GRAMS(g)
1	28
2	57
3	85
4	113
5	142
6	170
7	198
8	227

OUNCES(oz.)	GRAMS(g)
9	255
10	284
11	312
12	340
13	369
14	397
15	425
16	454

■ FLUID MEASUREMENTS

1 Cup	=	8 fluid ounces	=	240 ml.
1 Pint	=	16 fluid ounces	=	480 ml.
1 Quart	=	32 fluid ounces	=	960 ml.
1 Gallon	=	128 fluid ounces	=	3840 ml.

■ WEIGHT DEFROST AND COOK CONVERSION CHART

Ounces	Hundredths of a Pound	Tenths of a Pound	Grams
1-2	.06-.15	0.1	50
3-4	.16-.25	0.2	100
5-6	.26-.35	0.3	150
7	.36-.45	0.4	200
8-9	.46-.55	0.5	250
10-11	.56-.65	0.6	300
12-13	.66-.75	0.7	350
14	.76-.85	0.8	400
15-16	.86-.95	0.9	450

BEFORE YOU CALL FOR SERVICE

Refer to the following checklist, you may prevent an unnecessary service call.

- The oven doesn't work :
 1. Check that the power cord is securely plugged in.
 2. Check that the door is firmly closed.
 3. Check that the cooking time is set.
 4. Check for a blown circuit fuse or tripped main circuit breaker in your house.
- Sparking in the cavity;
 1. Check utensils. Metal containers or dishes with metal trim should not be used.
 2. Check that metal skewers or foil does not touch the interior walls.

If there is still a problem, contact the service station.

DO NOT ATTEMPT TO SERVICE THE OVEN YOURSELF !

Warranty



DAEWOO ELECTRONICS CORPORATION OF AMERICA warrants each new electronic product manufactured by it to be free from defective material and workmanship and agrees to remedy any such defect or to furnish a new part (at the Company's option) in exchange for any part of any unit of its manufacture which under normal installation, use, and service disclosed such defect, provided the unit is delivered by the owner to us or to our authorized distributor from whom purchased or authorized service station, intact, for our examination with all transportation charges prepaid to our factory, To establish and receive warranty service at our factory or authorized service facilities, proof of purchase/dated sales invoice is required

Return authorization must be obtained before any merchandise is returned to the factory.

This warranty does not extend to any of our electronic products which have been subjected to misuse, neglect, accident, incorrect wiring not our own, improper installation, unauthorized modification, or to use in violation of instructions furnished by us, nor units which have been repaired or altered outside of our factory, nor to cases where the serial number thereof has been removed, defaced, or changed

This warranty is in lieu of all warranties expressed or implied and no representative or person is authorized to assume for us any other liability in connection with the sale of our electronic products.

Over-the-counter exchange for units that are initially defective.

"Initially defective" is described as when the dealer opens the unit and finds that it is inoperative or a customer opens a new unit and finds that it is inoperable. This unit may be returned to the factory by the dealer for exchange. Under no circumstances will the customer be permitted to return the defective unit directly to the factory.

Exchange must be directly with the dealer.

Model	Parts	Labor	Magnetron
EW13F1ST	1 year	1 year	8 years

**For Service or Assistance, please call 1-800-553-4355 or visit website
www.e-daewoo.com**