

This Owner's Manual is provided and hosted by Appliance Factory Parts.

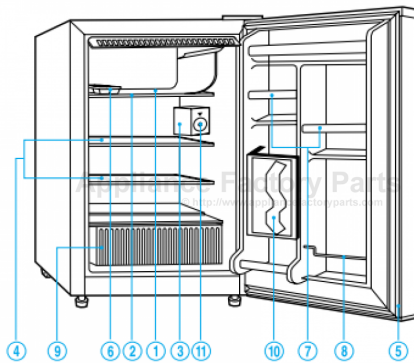

MAGIC CHEF MCBR445B Owner's Manual

[Shop genuine replacement parts for MAGIC CHEF
MCBR445B](#)



[Find Your MAGIC CHEF Refrigerator Parts - Select From 316 Models](#)

----- Manual continues below -----

Before Putting Into Use

- Before connecting the appliance to the power supply, let it stand for about 2 hours, which will reduce a possibility of malfunctions in the cooling system due to transport handling.
- Clean the appliance, and be thorough, especially in the interior (See Cleaning and Maintenance).
- In case the interior accessories are not correctly placed, rearrange them as described in chapter "NAME OF THE PARTS".

Instructions for Use

These instruction for use are intended for the user. They describe the appliance and its correct and safe use. They were prepared for various types/modes of refrigerators therefore you may find in it description of some functions and accesories that your appliance does not have.

Tips for Energy Savings

- Try not to open the door too often, especially when the weather is wet and hot. Once you open the door, mind to close it as soon as possible.
- Every now and then check if the appliance is sufficiently ventilated (adequate air circulation behind the appliance).
- Set thermostat from higher to lower settings as soon as possible (depends on how loaded the appliance is ambient temperature etc).
- Before loading the appliance with packages of fresh foods, make sure they are cooled to ambient temperature.
- Ice and frost layer increase energy consumption, so do clean the appliance as soon as the layer is 1/8" thick.

Important

- If you have bought this appliance cannot be opened from inside. This will make it impossible for and suffocate.
- The appliance must be correctly install)
- Do not touch the cooled surface with wet hands, because the
- Do not freeze bottles containing mineral water, sparkling wine freezing and the glass bottle
- Do not eat frozen food (bread frostbites).
- If the food has strange smell that it is spoiled and therefore
- Disconnect the appliance from qualified technician should re
- Do not defrost the appliance never scrape the ice or frost
- The rating plate is inside the

DANGER: Risk of child entering refrigerator of fre can not climb on

NAMES OF THE PARTS

HOW TO OPEN

Starting your new R

1. Clean the refrigerator thoroughly the interior with a clean moist cloth.
2. Insert the power supply cord into the power outlet.
3. Turn the thermostat dial to the coldest setting and allow the refrigerator to operate for 15-20 minutes.

Temperature control

To control the internal temperature, turn the thermostat dial. The dial is numbered from 1-7. Number 1 is the warmest setting and number 7 the coldest. The dial may be set anywhere between 1 and 7. It does not have to be set exactly on a number. To make ice cubes in the ice cube tray, adjust the thermostat dial to the coldest setting.

NOTE: Wait 3-5 minutes before using the refrigerator. The unit may fail to operate if the thermostat dial is set to the coldest setting.

How to defrost

■ **MCBR170B/MCBR170S/MCBR170W**
 Defrost the refrigerator when the ice layer is 5mm (1/5inch) thick. Set the thermostat dial to "OFF" and remove the ice cube tray in place. Defrosting usually takes 15-20 minutes. Remove foods from the refrigerator and allow them to thaw. Do not use a metal instrument to scrape the ice. Empty the water from drip tray and dry it.

■ **MCBR445B/MCBR445S/MCBR445W**
 Just push the defrost button on the control panel. Turn the thermostat dial to the coldest setting. When the defrosting is complete, turn the refrigerator works without any ice. Close the door and drip tray in place.

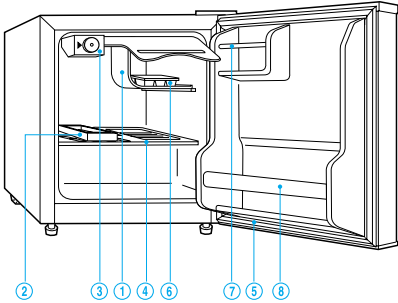
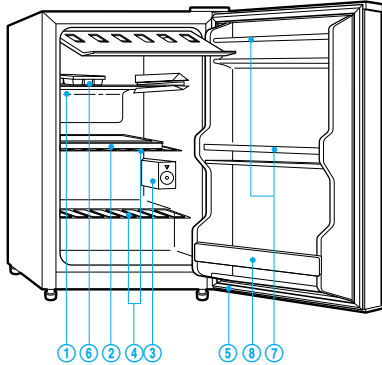
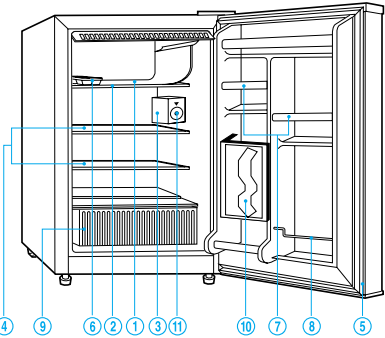
 <p>MCBR170B MCBR170S MCBR170W</p>	 <p>MCBR270B MCBR270S MCBR270W</p>
 <p>MCBR445B MCBR445S MCBR445W</p>	<ul style="list-style-type: none"> ① Chiller ② Drain Pan ③ Control Box ④ Shelf ⑤ Magnetic Door Seal ⑥ Ice Cube Tray ⑦ Rack ⑧ Bottle Rack ⑨ Crisper ⑩ Can Dispenser ⑪ Defrost Button

HOW TO CLEAN

Cleaners : Never use harsh, abrasive cleaners, heavy-duty cleaners, or solvents on any surface.

Exterior : Wipe with damp, sudsy cloth, rinse and dry. For stubborn stains and for periodic waxing, use silicon wax.

Freezer : When refrigerator needs defrosting turn thermostat dial to "OFF". Do not use sharp instruments to scrape off ice/frost.

Refrigeration Section : Wash shelves and other removable parts in warm sudsy water, rinse and dry. Wash interior with baking soda solution (3 Tablespoons to 1 Liter of water) or warm sudsy water, rinse and dry.

Magnetic Door Seals : Wash with warm sudsy water.

The Finishing Touch : Replace all parts and return thermostat dial to desired setting.

HOW TO INSTALL

■ Install refrigerator in a convenient location away from extreme heat and cold. Allow sufficient clearance between the refrigerator and side wall so the door will open without obstruction. Refrigerator is not designed for recessed installation.

■ Select a space with strong level floor.

■ Allow 5 inches of space between the refrigerator's side and the wall.

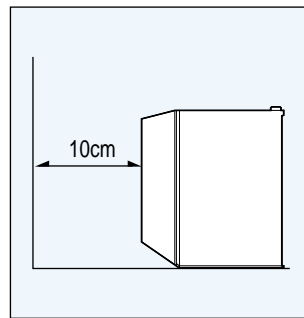

POWER CORD REPLACEMENT

If the refrigerator's power cord is damaged, have it replaced by a qualified repair agent.

WHAT TO DO

When the fridge is not in use

- Remove the power plug from the outlet.
- Remove all contents from the refrigerator.
- Dry the interior and leave the door open.

When you wish to move the fridge

- Secure all movable parts and doors.
- (Package them separately if necessary.)
- Transport the fridge only in a horizontal position to avoid damage to the compressor.

Before calling service, please check the following:

This may save you an expensive service call.

If the refrigerator seems to be making noise

- Check that the door has not opened.
- Check that the interior circulation fans are not hitting any goods stored. (The fridge is not designed for recessed installation.)
- Did you store anything hot, or cold, in the refrigerator?
- Is there sufficient clearance between the refrigerator and the wall?

If the fridge starts making a rattling noise

- Is it wobbling? Re-level it and check the floor.
- Have any objects fallen behind the refrigerator? When operation is now normal.
- Are any containers inside the refrigerator? Check to see if they are blocking the fans.

WARNING-Improper use of an extension cord can cause a fire or electric shock. If it is necessary to use an extension cord that has a 3-prong ground fault circuit interrupter (GFCI) will accept the plug on the appliance. The extension cord should be AC115-120V. Always make sure the receptacle is properly grounded.

CHANGING THE REVERSIBLE DOOR

This refrigerator has been built with the door hinges on the right.

If you wish to change the opening direction, follow the instruction below:

- Unplug the refrigerator from its electrical outlet.
- Empty everything in the refrigerator, including shelves, food, etc.

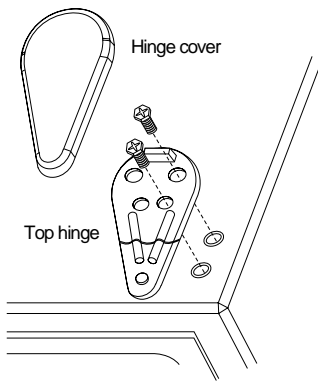
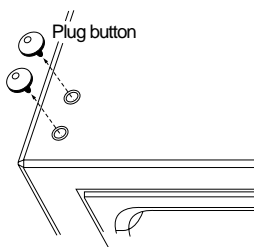
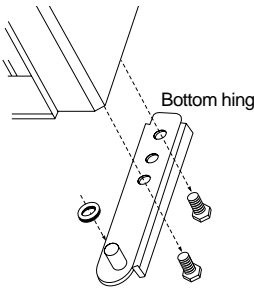
<ol style="list-style-type: none"> 1. Remove the hinge cover on the right top of the cabinet. 2. Remove the two screws (using a ratchet tool with a 8MM socket) that hold the top hinge to the cabinet. Keep these screws for later use. 3. Lift the top hinge straight up to free the pin from the socket on the top of the door. 4. Lift the door and place it on a padded surface to prevent scratching it. 	 <p>Hinge cover</p> <p>Top hinge</p>
<ol style="list-style-type: none"> 5. Remove the plug buttons from the upper left holes as illustrated and transfer them to the uncovered holes at the right side. Be sure to press the plug buttons firmly into the holes. 	 <p>Plug button</p>
<ol style="list-style-type: none"> 6. Lay the cabinet on its side down on the floor. Remove the two screws that hold the bottom hinge to the cabinet using a 10MM socket. Keep these screws and washer for later use. 	 <p>Bottom hinge</p>

7. Insert the bottom hinge at the top of the door using the two screws previously removed in step 6.

NOTE: Do not tighten screws.

8. Stand the cabinet.

9. Replace the door making sure the socket enters the bottom hinge. Be sure washer is in place.

10. While holding the door in the open position, secure the top hinge to the cabinet using the two screws previously removed at the beginning. Do not tighten the screws until the door is leveled with the cabinet.

11. Replace the hinge cover.

12. Replace plugs.

13. Tools required:
 - 8MM & 10MM socket-ratchet
 - Putty knife or thin-blade



Refrigerator Warranty

Daewoo Electronic America, Inc warrants each new Refrigerator to be free from defects in material and workmanship and agrees to remedy any such defect or to furnish a new part(s) (at the company's option) for any part(s) of the unit that has failed during the warranty period. Parts and labor expenses are covered on this unit for a period of one year after the date of purchase. In addition Daewoo Electronics America, Inc warrants the compressor (parts only) to be free from defects in material and workmanship for a period of 5 years. The consumer is responsible for all labor and transportation expenses related to the diagnosis and replacement of the compressor after the initial one- year warranty has expired. If in the event the unit requires replacement or refund under the terms of this warranty the consumer is responsible for all transportation expenses to return the unit to our factory prior to receiving a replacement unit or refund. **A copy of the dated sales receipt / invoice is required to receive warranty service.**

This warranty covers appliances in use within the continental United States, Puerto Rico and Hawaii. The warranty does not cover the following:

- Damages due to shipping damage or improper installation.
- Damages due to misuse or abuse.
- Content losses due to failure of the unit.
- Inside components such as door panels, door shelves, racks, light bulbs etc...
- Punctures to the evaporator system due to improper defrosting of the unit.
- Repairs performed by unauthorized service agents.
- Service calls that do not involve defects in material and workmanship such as instruction on proper use of the product, door reversal or improper installation.
- Replacement or resetting of house fuses or circuit breakers.
- Failure of this product if used for other than its intended purpose.
- Disposal costs of failed units not returned to our factory.

This warranty is in lieu of all warranties expressed or implied and no representative or person is authorized to assume for us any other liability in connection with the sale of this product. Under no circumstances is the consumer permitted to return this unit to the factory without prior written consent from MC Appliance Corporation.

Model	Parts	Labor	Compressor (Part Only)	Type of Service
Refrigerator	One- Year	One- Year	Five Years	Carry In
Model : MCBR170B, MCBR170S, MCBR170W, MCBR270B, MCBR270S, MCBR270W, MCBR445B, MCBR445S, MCBR445W				

For Service or Assistance please call 800 553-4355 or 888 775-0202 or visit us on the web at www.magicchef-ewave.com

Model No.: **MCBR170**
MCBR170
MCBR170

- Before use, please read this m
- Always remove the drain pan v
- Removing the drain pan will er