

This Owner's Manual is provided and hosted by [Appliance Factory Parts](http://ApplianceFactoryParts.com).

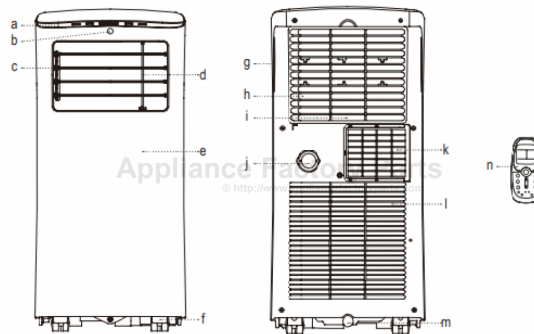

MAGIC CHEF MCPAC10KM Owner's Manual

[Shop genuine replacement parts for MAGIC CHEF
MCPAC10KM](#)



[Find Your MAGIC CHEF Air Conditioner Parts - Select From 21 Models](#)

----- Manual continues below -----

OWNER'S MANUAL

Master Craft®

8000 BTU Portable Air Conditioner
10000 BTU Portable Air Conditioner

NOK7C
NOK7D

**Please read the entire
manual carefully to
ensure proper operation
of the product.**

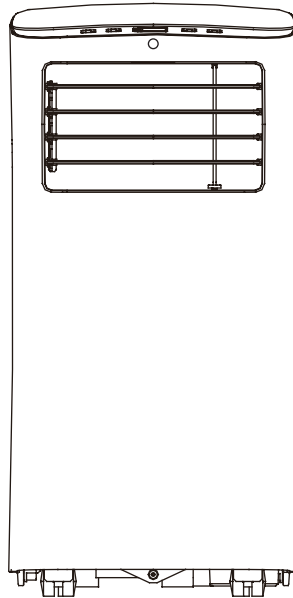

PRODUCT REGISTRATION

Thank you for purchasing a Master Craft® product. The first step to protect your new product is to complete the product registration on our website: www.mcappliance.com/register. The benefits of registering your product include the following:

1. Registering your product will allow us to contact you regarding a safety notification or product update.
 2. Registering your product will allow for more efficient warranty service processing when warranty service is required.
 3. Registering your product could act as your proof of purchase in the event of insurance loss.
- Once again, thank you for purchasing our product.

CONTENTS

PRODUCT REGISTRATION.....	2
IMPORTANT SAFETY INSTRUCTIONS.....	4
SPECIFICATIONS.....	6
PARTS IDENTIFICATION.....	7
INSTALLATION INSTRUCTIONS.....	8
REMOTE CONTROL.....	13
OPERATION INSTRUCTIONS.....	15
CARE AND MAINTENANCE.....	18
TROUBLESHOOTING.....	19
LIMITED WARRANTY.....	20

IMPORTANT SAFETY INSTRUCTIONS

▲ **NOTE:** This User Manual encompasses information for both the MCPAC8KM and the MCPAC10KM. Make note of the unit you own while reading operation instructions as there may be some discrepancies.

EXPLANATION OF SYMBOLS

▲ **WARNING:** Hazards or unsafe practices which COULD result in severe personal injury or death.

▲ **CAUTION:** Hazards or unsafe practices which COULD result in minor personal injury or property damage.

IMPORTANT SAFETY INSTRUCTIONS

1. Read all instructions before using the appliance.
2. ▲ **WARNING:** To prevent injuries or property damage, the following instructions must be followed.
3. This appliance should not be operated, cleaned or maintained by anyone that is not able to follow proper safety procedures or does not have experience with this type of equipment, unless under close supervision.
4. ▲ **WARNING:** DO NOT use in an area where it may be exposed to combustible gases or liquids, as this may cause a fire.
5. ▲ **CAUTION:** Installation must be performed according to the installation instructions and ALWAYS use the correct tools as specified. Use only accessories and parts included with the appliance. Improper installation can cause water leakage, electrical shock, or fire.
6. Place the unit on a level, sturdy section of the floor, away from heat sources or anywhere it could get wet.
7. DO NOT operate in a wet environment, such as a bathroom or laundry room.
8. DO NOT stand, sit, or place anything on top of the unit.
9. DO NOT let children operate or play on or around the air conditioner. Children should be supervised around the unit at all times.
10. ▲ **CAUTION:** The power cord is equipped with a 3-prong grounding plug to protect against shock hazards. ALWAYS plug cord into a properly installed and grounded 3-prong wall receptacle. Refer to the manufactures rating label for electrical and other technical data specific to this unit.
11. DO NOT modify or cut the power cord, or use any other cord or plug. If the cord or plug is damaged, DO NOT use. Contact customer service or a qualified service technician for replacement or repair.
12. DO NOT run cord under carpeting, throw rugs, runners, or similar coverings. DO NOT route cord under furniture, appliances, or any heavy object. Place the cord where it will not be tripped over.
13. DO NOT start or stop the unit by turning the power on or off.
14. DO NOT insert or pull out the plug with wet hands.
15. DO NOT use this item on a solid state speed control device (such as a fan control wall switch).
16. DO NOT obstruct the unit to ensure proper function and safety.
17. DO NOT insert your finger or other foreign objects into grills or openings.
18. ▲ **CAUTION:** ALWAYS turn off and unplug the unit prior to cleaning or maintenance.

19. Contact customer service or an authorized service technician for repair or maintenance of this unit. DO NOT try to take apart or repair the unit by yourself.
20. Turn off and unplug the unit if strange sounds, smells, or smoke come from it.
21. If the appliance is knocked over during use, turn off the unit and unplug it immediately. Visually inspect the unit to ensure there is no damage. If there is any damage, or you suspect the unit has been damaged, contact a technician or customer service for assistance.
22. If water spills into the unit, turn it off, unplug it, and contact a qualified service technician.
23. DO NOT try to move the unit when the tank is full, or force the castors to roll on carpet. Doing so may cause the unit to tip over and spill water.
24. ALWAYS insert the filters securely. Clean filter once every two weeks.

**READ AND FOLLOW THIS
SAFETY INFORMATION CAREFULLY
SAVE THESE INSTRUCTIONS**

SPECIFICATIONS

Figure 1

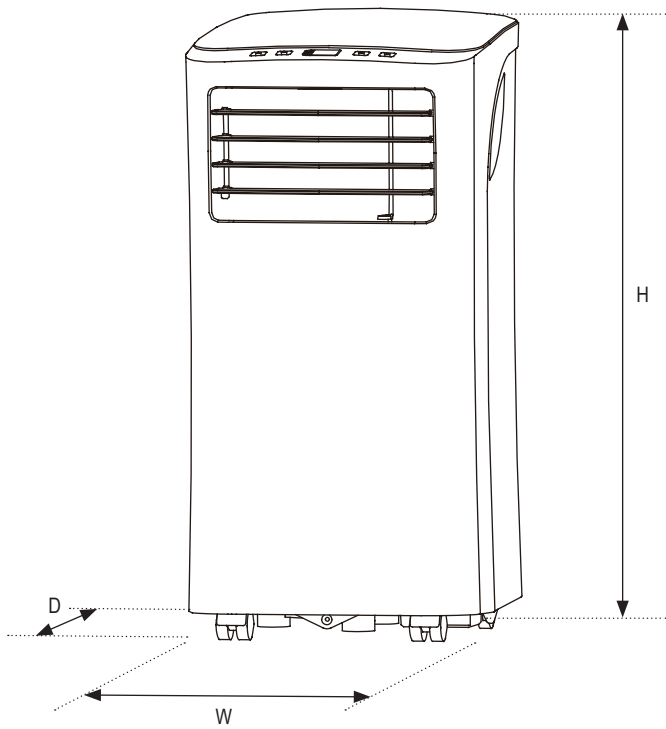

Model	MCPAC8KM	MCPAC10KM
Dimensions (W x H x D)	12.8" x 24.2" x 12.5"	14" x 27.7" x 13.6"
BTU	8000	10000
SACC BTU	3800	5500
Voltage	115V / 60Hz	115V / 60Hz
Watts	890	1110
Refrigerant Type	R410A / 9.52 oz.	R410A / 10.58 oz.
Operating Temperature Range	Cool Mode: 62-95°F (17-35°C) / Dry Mode: 55-95°F (13-35°C)	

PARTS IDENTIFICATION

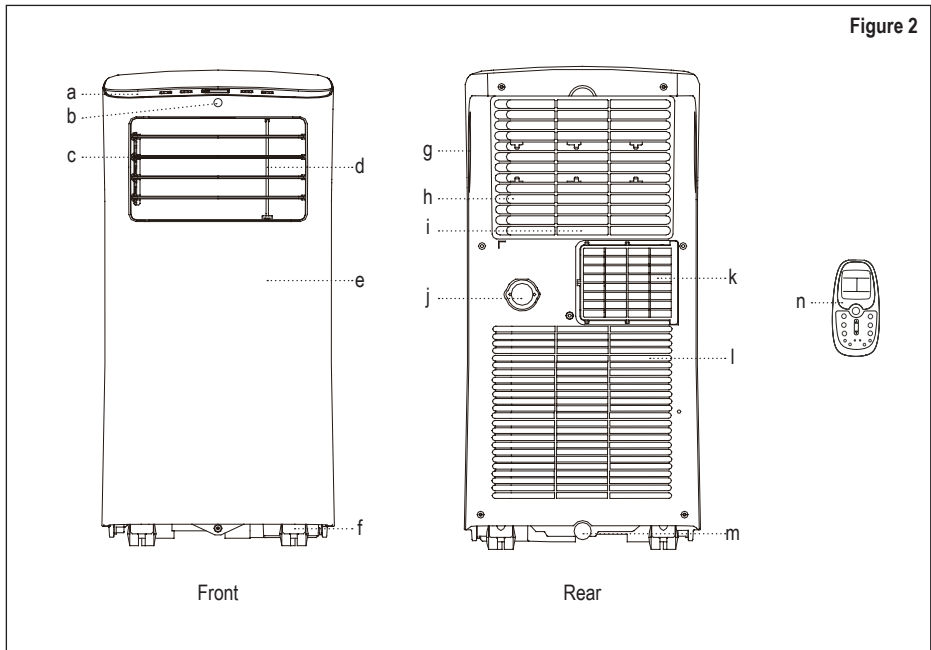

- | | | |
|--|-----------------------------------|-----------------------------|
| a. Control Panel | e. Panel | j. Drain Outlet |
| b. Remote Signal Receptor | f. Caster | k. Air Outlet |
| c. Horizontal Louver Control Lever
(Fixed or manually adjusted) | g. Handle (Both sides) | l. Lower Air Intake |
| d. Vertical Louver Control Lever
(Fixed or manually adjusted) | h. Air Filter (Behind the grille) | m. Bottom Tray Drain Outlet |
| | i. Upper Air Intake | n. Remote Control |

▲ **NOTE:** Exhaust hose and other installation accessories should not be discarded.









INSTALLATION INSTRUCTIONS

TOOLS NEEDED

- Medium Philips screwdriver
- Tape measure or ruler
- Knife or scissors
- Saw (optional, to shorten window adaptor for narrow windows)

ACCESSORIES

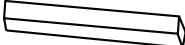
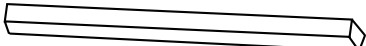
Your Window Installation Kit fits hung or sliding windows 26.5-48" (67.5-123cm) and can be shortened for smaller windows.

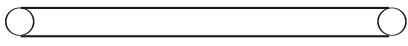
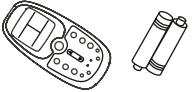
Part	Description	Quantity
	Unit Adaptor	1 pc
	Exhaust Hose	1 pc
	Window Slider Adaptor	1 pc
	Bolt	1 pc
	Window Slider A	1 pc
	Window Slider B	1 pc
	Foam Seal A (Adhesive)	2 pc
	Foam Seal B (Adhesive)	2 pc
	Foam Seal C (Non-Adhesive)	1 pc
	Security Bracket and 2 Screws	1 set
	Drain Hose	1 pc
	Remote Controller and Battery	1 set

LOCATION

Your installation location should meet the following requirements:

- Make sure that you install your unit on a level surface to minimize noise and vibration.
- The unit must be installed near a grounded plug, and the Collection Tray Drain (found on the back of the unit) must be accessible.
- The unit should be located at least 12" (30cm) from the nearest wall to ensure proper air conditioning.
- DO NOT cover the Intakes, Outlets or Remote Signal Receptor of the unit, as this could cause damage to the unit.

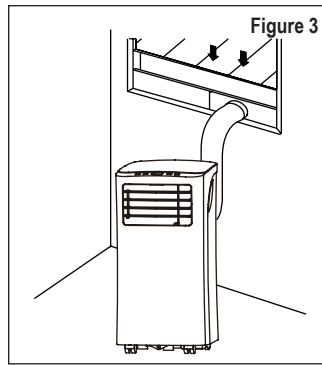

WINDOW INSTALLATION KIT

1. Preparing the Exhaust Hose Assembly:
Press the exhaust hose into the window slider adaptor and unit adaptor and clamp with the buckles of the adaptor.
2. Attach the Exhaust Hose Assembly to the Unit:
Push the Exhaust hose into the air outlet opening of the unit along the arrow direction.
3. Prepare the Adjustable Window Slider:
Measure the size of your window opening. If needed, cut the window slider to the correct length. You may need both window sliders, in which case, slide Window Slider B into Window Slider A, adjust to correct size, and use the bolt to fasten the window sliders together.

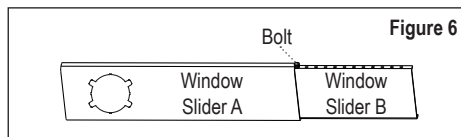
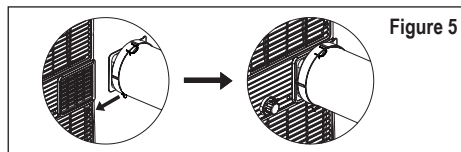
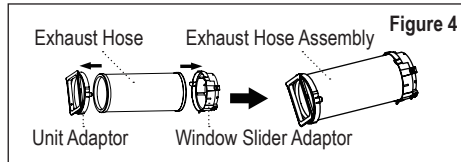

INSTALLTION

▲ NOTE: Once the Exhaust Hose Assembly and Adjustable Window Slider are prepared, install according to the type of window you are using.

Type 1: Hung Window Installation	
1	<p style="text-align: right;">Cut the adhesive foam seal A and B strips to the proper lengths, and attach them to the window sash and frame as shown.</p>

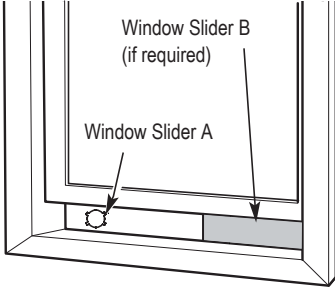
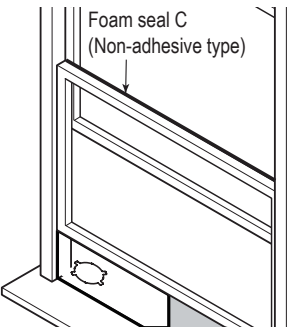
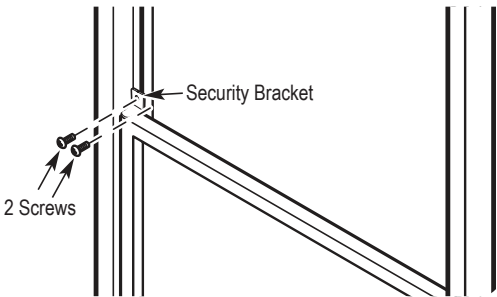
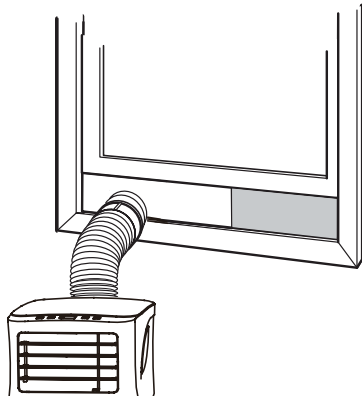
2	 <p>Window Slider B (if required)</p> <p>Window Slider A</p>	<p>Insert the window slider assembly into the window opening.</p>
3	 <p>Foam seal C (Non-adhesive type)</p>	<p>Cut the non-adhesive foam seal C strip to match the width of the window. Insert the seal between the glass and the window frame to prevent air and insects from getting into the room.</p>
4	 <p>Security Bracket</p> <p>2 Screws</p>	<p>If desired, install the security bracket with 2 screws as shown.</p>
5		<p>Insert the window slider adaptor into the hole of the window slider.</p>

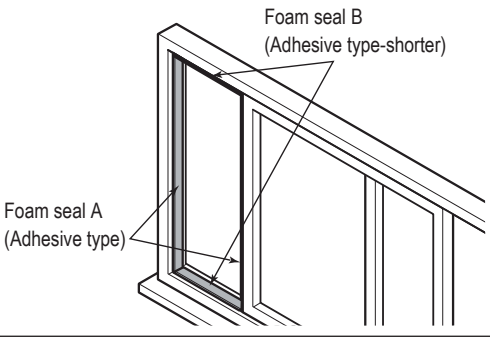
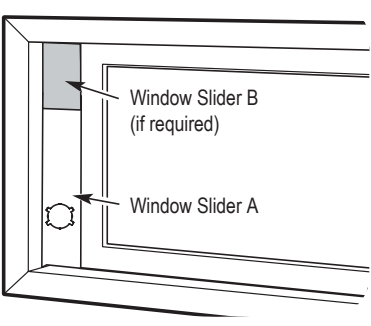
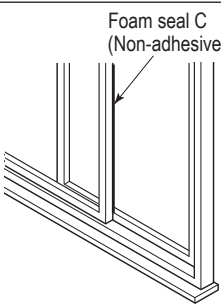
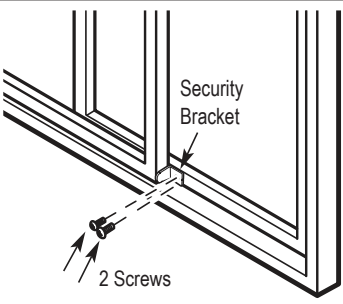
Type 2: Sliding Window Installation		
1		<p>Cut the adhesive foam seal A and B strips to the proper lengths, and attach them to the window sash and frame as shown.</p>
2		<p>Insert the window slider assembly into the window opening.</p>
3		<p>Cut the non-adhesive foam seal C strip to match the window height. Insert the foam seal between the glass and the window frame to prevent air and insects from getting into the room.</p>
4		<p>If desired, install the security bracket with 2 screws as shown.</p>

5

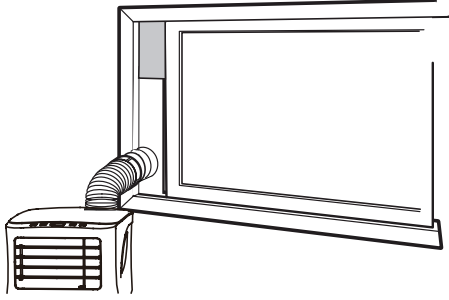

Insert the window slider adaptor into the hole of the window slider.

▲ NOTE: To ensure proper function, DO NOT overextend or bend the hose. Make sure that the air outlet of the exhaust hose has a clearance of about 20 in. (48cm). These illustrations are for explanation only, your air conditioner may be slightly different.

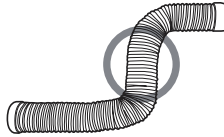

Figure 7

REMOTE CONTROL

Before you begin using your new air conditioner, make sure to familiarize yourself with the remote control. The following is a brief introduction to the remote control itself. For instructions on how to operate your air conditioner, refer to the OPERATING INSTRUCTIONS section of this manual.

For best results, make sure you are pointing the remote control at the air conditioner. The remote has a range of about 26' (8m), and there will be a beep from the A/C unit when the remote signal is received. Anything obstructing a direct line between the remote and the unit, as well as direct sunlight, may interfere with the signal.

FUNCTION BUTTONS

- Button designs on your unit may differ slightly from the example shown. If the unit does not have a particular function, pressing that function button on the remote control will have no effect.
 - See OPERATING INSTRUCTIONS section for more detailed information on the functions controlled by the remote control.
- a. Power On/Off
 - b. Mode – Cycles through function modes.
 - c. Time/Temp – Adjusts set temperature and Timer-On/Timer-Off time.
 - d. Sleep – Starts and stops SLEEP Mode.
 - e. Reset – Recessed button to reset all settings for remote.
 - f. Fan – Sets the Fan Speed.
 - g. Timer – For setting Timer-On or Timer-Off.
 - h. Cancel – Cancels Timer modes.
 - i. Clock – Used to set the clock.
 - j. LED – Turns LED Display in A/C unit On and Off.
 - k. Lock – Recessed button to lock or unlock current settings for remote.

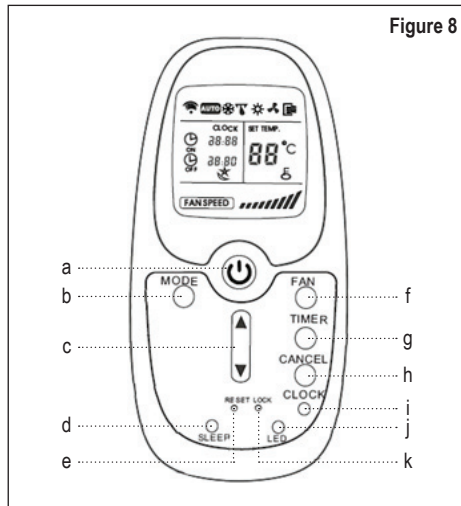

REMOTE CONTROL DISPLAY

- a. Transmitter Indicator – Lights when remote is transmitting.
- b. Mode Display – Shows current operation Mode. AUTO – COOL – DRY – FAN
- c. ON/OFF Display – Shows status of A/C Unit.
- d. Time Display – Shows Timer-On/Off time (0-24 hrs.). If Timer is not set, displays current time. To view current time while Timer is set, push the Clock button.
- e. Sleep Display – Indicates if Sleep Mode is on.

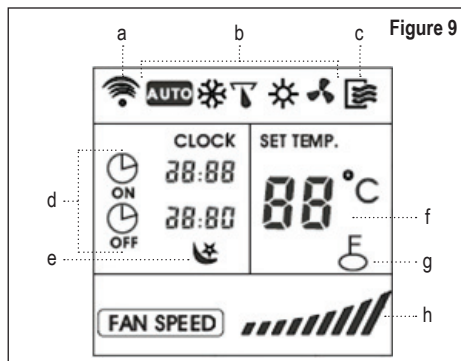

- f. Temperature Display – Shows temp setting. Off when unit is in FAN Mode.
- g. Lock Display – Lit when the remote control is locked.
- h. Fan Speed Display – Shows set fan speed of AUTO, low, medium, or high. Not all models have medium speed. Displays AUTO in DRY mode.

INSERTING AND REPLACING BATTERIES

Your remote control uses two AAA batteries. To install or replace batteries:

1. Slide the cover on the back of the remote downward, exposing the battery compartment.
2. Insert the batteries, making sure the (+) and (-) ends of the batteries match the symbols inside the battery compartment.
3. Slide the battery cover back into place and reset the clock.

▲ NOTE: For optimum performance, do not mix old and new batteries.

It is recommended to remove the batteries if the remote will not be used for more than 2 months. Always be sure to properly dispose of old batteries.

The device complies with the local national regulations. In Canada, it complies with CAN ICES-3(B)/NMB-3(B). In the USA, this device complies with part 15 of the FCC Rules. Operation is subject to the following two conditions: (1) This device may not cause harmful interference, and (2) this device must accept any interference received, including interference that may cause undesired operation.

This equipment has been tested and found to comply with the limits for a Class B digital device, pursuant to part 15 of the FCC Rules. These limits are designed to provide reasonable protection against harmful interference in a residential installation. This equipment generates, uses and can radiate radio frequency energy and, if not installed and used in accordance with the instructions, may cause harmful interference to radio communications. However, there is no guarantee that interference will not occur in a particular installation. If this equipment does cause harmful interference to radio or television reception, which can be determined by turning the equipment off and on, the user is encouraged to try to correct the interference by one or more of the following measures:

- Reorient or relocate the receiving antenna.
- Increase the separation between the equipment and receiver.
- Connect the equipment into an outlet on a circuit different from that to which the receiver is connected.
- Consult the dealer or an experienced radio/TV technician for help.

Changes or modifications not approved by the party responsible for compliance could void user's authority to operate the equipment.

OPERATING INSTRUCTIONS

CONTROLS

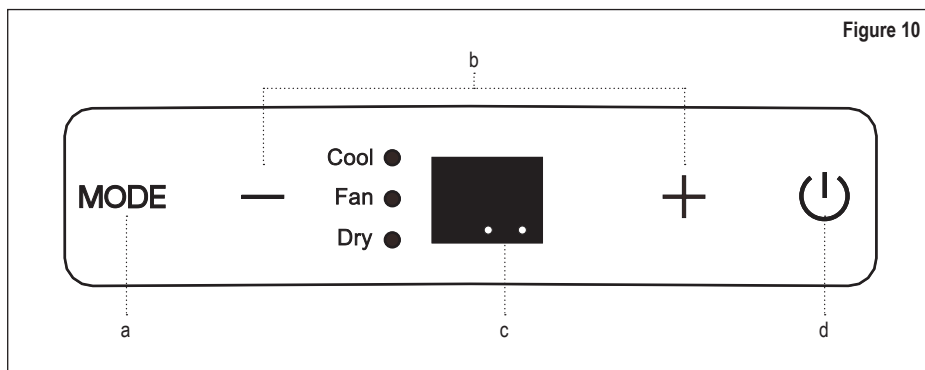

- a. Mode Button: Selects the operating mode. Each time you press the button, a mode will change from COOL> FAN>DRY. The mode indicator light indicates what mode is set.

▲ **NOTE:** The unit operates the fan speed automatically. You can only set the fan speed with the remote controller in COOL and FAN modes.

- b. Down (-) and Up (+) Buttons: Used to adjust the temperature settings in 1° (F or C) increments in a range of 62°F/17°C to 86°F/30°C.

▲ **NOTE:** The control is capable of displaying temperature in Fahrenheit or Celsius. To change from F to C, press and hold the Up and Down buttons at the same time for 3 seconds.

- c. LED Display: Shows the set temperature while on COOL mode, and room temperature when in DRY and FAN modes.

Error Codes

- E1: Room temperature sensor error
- E2: Evaporator temperature sensor error
- E4: Display panel communication error

Protection Code

- P1 - Bottom tray is full: Connect the drain hose and drain the collected water. If code repeats, call for service.

▲ **NOTE:** When one of the above malfunctions occurs, turn off the unit and check for any obstructions. Restart the unit and if the error code is still present, turn off the unit and unplug the power cord. Contact customer service or a service technician.

- d. Power button: Use to turn the unit On or Off.

OPERATING

Cool Mode

- Press the "MODE" on the unit or the remote button until the "COOL" indicator lights.
- Press the ADJUST buttons "+" or "-", or TEMP Up or Down on the remote, to select your desired room temperature. The temperature can be set within a range of 62°F~86°F /17°C~30°C.
- Press the "FAN SPEED" button on the remote to choose fan speed.

Dry Mode

- Press the "MODE" button on the unit or the remote until the "DRY" indicator lights.
- The temperature and fan speed cannot be adjusted in this mode. The fan will operate at Low speed.
- Keep windows and doors closed and do not run the exhaust duct to window.

Auto Mode (Remote Control Only)

- Press the "MODE" button until the "AUTO" indicator lights.
- Press the Temp Up or Down on remote select your desired room temperature. The temperature can be set within a range of 70°F~83°F /21°C~28°C. The fan speed cannot be changed in this mode.
- The unit will run either Cooling or Fan only to maintain room temperature.

Fan Mode

- Press the "MODE" button on the unit or the remote until the "FAN" indicator lights.
- Press the "FAN SPEED" button on remote control to choose the fan speed. The temperature cannot be adjusted.
- Do not run the exhaust duct to window.

Timer Mode (Remote Control Only)

- This feature is for setting the unit to turn on, off, or both, in a set number of hours.
- Press Timer button until Timer On or Timer Off on display is flashing.
- Press or hold the UP or DOWN button to set the Auto time in 0.5 hour increments, up to 10 hours, then in 1 hour increments up to 24 hours. After 3 seconds with no button being pressed, the time will set and the Timer-On / Timer-Off icon will stop flashing. The control will count down the time remaining until starting and/or stopping.
 - ▲ **NOTE:** The Timer feature counts down the time set for On or Off, it is not based on the current time.
- To set both an Auto-On and Auto-Off timers, first set the Timer On or Off to the desired length of time, then push the Timer button again, then set the desired Timer Off or On. For example, if it is currently 1:30pm, and you would like to set the A/C to turn on at 5:30pm, and then off at 10:30pm, press Timer button until Timer On flashes. Set timer for 4 hours. Press Timer button again and Timer Off will flash. Set timer for 9 hours. Unit will turn on in 4 hours, and off in 9 hours.
 - ▲ **NOTE:** The Timer On / Off function is controlled by the remote. It must be pointed at and within range of the unit.

Sleep/Eco Mode (Remote Control Only)

- Pressing the Sleep button in COOL mode will allow the set temperature to increase by 2°F / 1°C after 30 minutes, and again after another 30 minutes. The unit will maintain the new temperature for 7 hours, and then return to the previously selected temperature setting.
 - ▲ **NOTE:** Sleep Mode function is controlled by the remote. It must remain within range and pointed at the unit.
 - ▲ **NOTE:** This feature is not available in FAN or DRY mode.

Other Features

- Setting Or Adjusting The Clock (Remote Control Only)
 1. When batteries are installed in the remote controller, the clock panel will display "12:00". Press and hold the CLOCK button for 3 seconds, the time begin to flash.

2. Press TEMP/TIME adjust button to set time. Push "UP" or "DOWN" to change the time forward or backward.
3. Each time you press the button, the time moves forward or backward by one minute. Hold the button to change the time in 10 minutes increments.
4. When the correct time is set, push and release the CLOCK button, or wait for 5 seconds until the time stops flashing.

▲ **NOTE:** The time of the CLOCK must be set before the AUTO-TIMER feature will operate.

▲ **NOTE:** Clock accuracy is within 15 seconds per day.

- Air Flow Direction Adjustment: Depending on the model, the air conditioner has either fixed or manually adjustable louvers.
- Auto-Restart: If the power to the unit is unexpectedly lost or shut off, the unit will maintain previous settings when it is restored.
- 3 Minute Delay: When the unit is stopped, shut off, or loses power, it cannot be restarted for 3 minutes to protect the cooling system. Operation will automatically start after 3 minutes.

DRAINING THE WATER

There are two ways to remove water collected while the unit is running.

1. **Manually empty the water bucket:** When the water level of the bottom tray reaches a predetermined level, the unit beeps 8 times and the display will show "P1". The air conditioning / dehumidification process will stop. The fan motor will continue to run (this is normal). Turn off and unplug the unit, carefully move it to a drain location, remove the bottom drain plug and let the water drain out. Reinstall the bottom drain plug and restart the unit until the "P1" symbol disappears. If the error repeats, call for service.

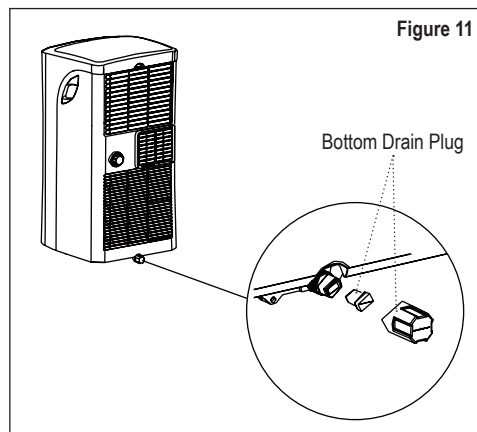

▲ **NOTE:** Be sure to reinstall the bottom drain plug firmly to prevent leakage before using the unit.

2. **Continuous Draining:** To drain continuously to a floor drain, connect the drain connector (5/8" universal female mender) with drain hose. Make sure the connection is tight and there is no leak and place the open end of the hose directly over the drain in your basement floor. The water hose should slope downward to allow the water to flow out smoothly.

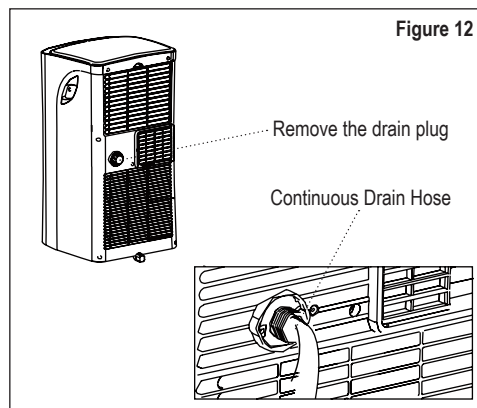

CARE AND MAINTENANCE

▲ **WARNING:** Turn the unit off and remove the plug from the wall outlet before maintenance or cleaning.

▲ **WARNING:** DO NOT use flammable liquids or chemicals to clean the unit.

- DO NOT immerse in or spray with water to clean.
- DO NOT operate the unit if the power cord is damaged.
- The water bucket should be cleaned every few weeks or as needed. DO NOT leave water in the bucket when unit is not being used. ALWAYS empty before storage or as soon as "P1" is displayed.

CLEAN THE AIR FILTERS

- Clean the air filters with water at least once every 2 weeks for optimal performance, or as needed. DO NOT use the unit with the filters missing.
- If used in a household with animals, periodically wipe down the grills to prevent animal fur from blocking airflow.

CLEANING THE PORTABLE AIR CONDITIONER

- Clean the unit using a damp, lint-free cloth and mild detergent (if needed) and dry off with a dry, lint-free cloth.

STORAGE

- Drain the unit's water collection tray according to the instructions.
- Run the unit on FAN mode for 12 hours in a warm room to dry it and prevent mold. Turn off the appliance and unplug it. Clean the air filter according to the instructions above. Reinstall the clean, dry filter before storing.
- Remove the batteries from the remote control.
- Be sure to store the unit in a cool, dark place. Exposure to direct sunshine or extreme heat can shorten the lifespan of the unit.

TROUBLESHOOTING

Please check the following before calling for service.

Problem	Possible Cause	Troubleshooting
Unit does not turn on when pressing ON/OFF button.	P1 Error Code	The Water Collection Tray is full. Turn off and unplug the unit, drain the water from the Water Collection Tray and restart the unit.
	In COOL mode: Room temperature is lower than the set temperature.	Reset the temperature.
Unit does not cool Well.	The air filter is blocked or dirty.	Turn off the unit and clean the filter according to instructions.
	Exhaust hose is not connected or is blocked.	Turn off the unit, disconnect the hose, check for blockage and reconnect the hose.
	The unit is low on Refrigerant.	Call customer service or service technician.
	Temperature setting is too High.	Decrease the set temperature.
	Windows or doors in room are open.	Make sure all windows and doors are closed.
	The room area is too large.	Double-check the cooling area.
	There are heat sources inside the room.	Remove the heat sources if possible.
The unit is noisy and vibrates too much.	The ground or the unit is not level	Place the unit on a flat, level surface, make sure unit is level.
	The air filter is blocked or dirty.	Turn off the unit and clean the filter according to instructions.
The unit makes a gurgling sound.	This sound is caused by the flow of refrigerant inside the unit.	This is normal.

Master Craft®

LIMITED WARRANTY

MC Appliance Corporation warrants each new PORTABLE AIR CONDITIONER to be free from defects in material and workmanship and agrees to remedy any such defect or to furnish a new part(s) (at the company's option) for any part(s) of the unit that has failed during the warranty period. Parts and labor expenses are covered on this unit for a period of one year from the date of purchase. In addition, MC Appliance Corporation warrants the compressor (parts only) to be free from defects in material and workmanship for a period of 5 years. The consumer is responsible for all labor and transportation expenses related to the diagnosis and replacement of the compressor after the initial one-year warranty expires. In the event that the unit requires replacement or refund under the terms of this warranty, the consumer is responsible for all transportation expenses to return the unit to our factory prior to receiving a replacement unit or refund. A refund or replacement will be issued at the discretion of MC Appliance Corporation. A copy of the dated sales receipt/invoice is required to receive warranty service or a refund.

This warranty covers appliances in use within the contiguous United States, Alaska, Hawaii and Puerto Rico. The warranty does not cover the following:

- Damages due to shipping damage or improper installation.
- Damages due to misuse or abuse.
- Content losses due to failure of the unit.
- Inside components such as the filter, etc.
- Repairs performed by unauthorized service agents.
- Service calls that do not involve defects in material and workmanship, such as instructions on proper use of the product or improper installation.
- Replacement or resetting of house fuses or circuit breakers.
- Failure of this product if used for purposes other than its intended purpose.
- Disposal costs for any failed unit not returned to our factory.
- Any delivery or installation costs incurred as the result of a unit that fails to perform as specified.
- Expenses for travel and transportation for product service if your appliance is located in a remote area where service by an authorized service technician is not available.
- The removal and reinstallation of your appliance if it is installed in an inaccessible location or is not installed in accordance with published installation instructions.
- Refunds for non-repairable products are limited to the price paid for the unit per the sales receipt.
- This warranty is non-transferable. This warranty applies only to the original purchaser and does not extend to any subsequent owners.

LIMITATIONS OF REMEDIES AND EXCLUSIONS

Product repair in accordance with the terms herein, is your sole and exclusive remedy under this limited warranty. Any and all implied warranties including merchantability and fitness for a particular purpose are hereby limited to one year or the shortest period allowed by law. MC Appliance Corporation is not liable for incidental or consequential damages and no representative or person is authorized to assume for us any other liability in connection with the sale of this product. Under no circumstances is the consumer permitted to return this unit to the factory without the prior written consent of MC Appliance Corporation.

Some states prohibit the exclusion or limitation of incidental or consequential damages, or limitations on implied warranties. This warranty gives you specific legal rights, and you may also have other rights which vary from state to state.

Model	Parts & Labor	Compressor (Part Only)	Type of Service
MCPAC8KM / MCPAC10KM	One-Year	Five Years	Carry In

For Service or Assistance, please call 888-775-0202, email to cshelp@mcappliance.com,
or visit us on the web at www.mcappliance.com.