

This Owner's Manual is provided and hosted by [Appliance Factory Parts](#).



Vermont Castings G36602 Owner's Manual

[Shop genuine replacement parts for Vermont Castings
G36602](#)



[Find Your Vermont Castings Grill Parts - Select From 273 Models](#)

----- Manual continues below -----



VERMONT CASTINGSTM_{MC}

VERMONT CASTINGS VANGUARDTM
VERMONT CASTINGS VANGUARD XETM

USER MANUAL

YOUR FEEDBACK IS IMPORTANT TO US
SHARE YOUR EXPERIENCE BY WRITING A REVIEW AT

WWW.CANADIANTIRE.CA

LAST UPDATE: SEP 25, 2020



WELCOME TO VERMONT CASTINGS

Founded in 1975, Vermont Castings has always stood for uncompromising commitment to quality craftsmanship and meaningful design. Our wood stoves and hearth products deliver more than heat – they create a warmth that unites.

Lit with purpose, our line of Vermont Castings barbecues are designed to deliver your best grilling experience. With a durable, robust construction built to last through the years, thoughtfully constructed components that stand up to grilling in any season, and a simplified system to make maintaining your investment easier, Vermont Castings continues the promise of unwavering quality and purposeful design.

Vermont Castings barbecues do more than just grill. They let you create enduring connections around food and flame.

CONTACT US: 1-844-586-4660
WWW.VERMONTCASTINGSBBQ.COM

PLEASE KEEP THIS MANUAL WITH YOUR
BARBECUE FOR FUTURE REFERENCE

GETTING STARTED

Make sure you know and understand the basics of safe use and installation.

WELCOME	2
FEATURES	4
NEED TO KNOW SAFETY	5–6
INSTALLATION	7–13

GRILLING LIKE A PRO

Every barbecue is different. Get our advice on best practices for operating your barbecue so you can always perform at your very best.

OPERATION—LIGHTING INSTRUCTIONS	14–16
RESOLVING IGNITION ISSUES	17–18
TIPS AND BEST PRACTICES	19
GRILLING GUIDE	21
SEASONING INSTRUCTIONS	22–23
DIRECT AND INDIRECT COOKING	24

TAKING CARE OF YOUR BARBECUE

Maintenance and performance go hand-in-hand. If you take responsibility for maintaining your barbecue, it will perform for years to come.

TAKING CARE OF YOUR BARBECUE	25–27
------------------------------	-------

CUSTOMER SUPPORT

If you run into problems, this is your first stop to getting the answers you need.

TROUBLESHOOTING	28–29
WARNING	30
SERVICE	31
WARRANTY	32–33

THE VC PROMISE

Thoughtfully designed and constructed, the VC Grilling Promise is our commitment to delivering an exceptional grilling experience, every time.

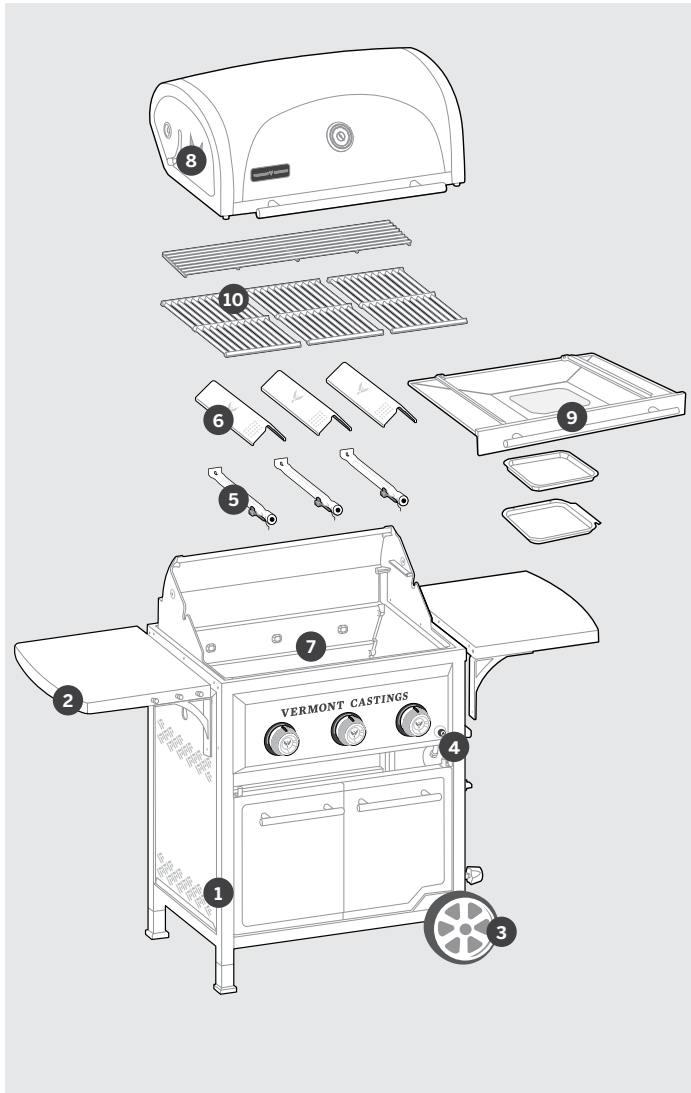

BUILT TO LAST

DURA-Structure™ Construction

provides an exterior structure that stands up to extreme conditions.

1. Robust Steel Frame.
2. Load-Bearing Side Shelves.
3. Industrial Cart Design.

SURE-Spark™ Ignition System

is weather-sealed and lab-tested, providing you a safe and reliable spark, every time.

4. Electronic ignition.

PERFORMANCE PERFECTED

STEADY-Fire™ Integrated Heat-Control System

enables even-heat distribution across your barbecue for mouth-watering cooking results.

5. 304 Stainless Steel Burners.
6. 304 Stainless Steel Heat Plates.
7. Extra Deep Cookbox.

CAST-Advantage™

delivers heat retention for all-season cooking.

8. Cast Iron Lid Ends

MAINTENANCE MADE EASY

EASY-Care™ Design

helps you maintain your barbecue for long-lasting performance.

9. Front-Access Grease Management Tray.
10. Porcelain-coated Cast Iron OR 304 Stainless Steel Cooking Grates.



STATEMENTS ARE USED THROUGHOUT THIS OWNER'S MANUAL TO EMPHASIZE CRITICAL AND IMPORTANT INFORMATION. READ AND FOLLOW THESE STATEMENTS TO HELP ENSURE SAFETY AND PREVENT PROPERTY DAMAGE. THE STATEMENTS ARE DEFINED BELOW.

CAUTION: INDICATES DEATH OR SERIOUS INJURY WILL RESULT IF PROPER PRECAUTIONS ARE NOT TAKEN.

WARNING: INDICATES DEATH, SERIOUS INJURY OR PROPERTY DAMAGE CAN RESULT IF PROPER PRECAUTIONS ARE NOT TAKEN.

DANGER: INDICATES SOME INJURY OR PROPERTY DAMAGE MAY RESULT IF PROPER PRECAUTIONS ARE NOT TAKEN.

NEED TO KNOW SAFETY

FOR YOUR FAMILY'S SAFETY, PLEASE CHECK THE FOLLOWING:

- READ and UNDERSTAND the owner's manual and safety instructions.
- DO NOT position or operate barbecue under overhang or unprotected construction, against a wall, near aluminum siding, windows, or fencing.
- CHECK that the regulator is correctly centred to the LP tank valve.
DO NOT cross thread this connection, as it may result in a gas leak, fire, or explosion.
- PERFORM LEAK TEST on all connections as specified in this user manual. Leak checks should be performed on all new barbecues even if assembled by an assembler or gas technician.
- BEFORE OPENING THE GAS SUPPLY, ensure the lid is open and all control knobs are in "OFF" position.
Follow the PROPER LIGHTING PROCEDURE as outlined in this manual. Failure to perform proper lighting steps will result in the following: difficulty lighting, low or irregular flames and other performance issues.
- Beware of HOT SURFACES including lid, lid handle, side tables, and control panel. Wear protective gloves while barbecuing.
- Remove and clean the grease tray, and heat distribution plates, to avoid grease fires and flare ups.
- Remove and clean the burners to avoid flashback fires caused by spider webs and blockages.
- Ensure that the barbecue is on a level surface.

THIS MANUAL MUST REMAIN WITH YOUR BARBECUE AT ALL TIMES



THIS BARBECUE IS FOR OUTDOOR USE ONLY

CAUTION: READ AND FOLLOW ALL SAFETY STATEMENTS, ASSEMBLY INSTRUCTIONS, USE AND CARE DIRECTIONS BEFORE ATTEMPTING TO ASSEMBLE AND COOK.

INSTALLER OR ASSEMBLER/CONSUMER: THIS MANUAL SHOULD BE KEPT WITH THE BARBECUE AT ALL TIMES.

WARNING: FAILURE TO FOLLOW ALL OF THE MANUFACTURER'S INSTRUCTIONS COULD RESULT IN HAZARDOUS FIRES, EXPLOSIONS, PROPERTY DAMAGE, OR SERIOUS PERSONAL INJURY OR EVEN DEATH.

FOLLOW ALL LEAK CHECK PROCEDURES CAREFULLY PRIOR TO OPERATION OF BARBECUE, EVEN IF THE BARBECUE WAS DEALER ASSEMBLED. DO NOT TRY TO LIGHT THIS BARBECUE WITHOUT READING THE LIGHTING INSTRUCTION SECTION OF THIS MANUAL. SEE OPERATION LIGHTING INSTRUCTIONS, PAGE 14.

DANGER:

1. IF YOU SMELL GAS:

- A. SHUT OFF GAS TO THE BARBECUE.
- B. EXTINGUISH ANY OPEN FLAME.
- C. OPEN LID.

- D. IF ODOUR CONTINUES, STAY AWAY FROM THE BARBECUE AND IMMEDIATELY CALL YOUR GAS SUPPLIER OR YOUR FIRE DEPARTMENT.

WARNING: DO NOT STORE OR USE GASOLINE OR OTHER FLAMMABLE LIQUIDS OR VAPOURS IN THE VICINITY OF THIS OR ANY OTHER BARBECUE.

WARNING: AN LP CYLINDER NOT CONNECTED FOR USE SHALL NOT BE STORED IN THE VICINITY OF ANY OTHER BARBECUE.

CAUTION: IN DIRECT SUN, AND IN OPERATION, THE STAINLESS STEEL AND PAINTED STEEL PARTS CAN BECOME VERY HOT. USE EXTREME CAUTION.

NEED TO KNOW SAFETY

GRILL SAFETY CHECKLIST

DO's AND DON'T's

CHOOSING A LOCATION

DO set up the barbecue outdoors, in a well-ventilated area.

DO position your barbecue on a level surface.

DO always keep the area around this barbecue clean and clear of any and all combustible materials, such as: gasoline or other inflammable liquids, paper or oily rags.

DO position the barbecue at least 36" (91.44 cm) from any dwelling or building.

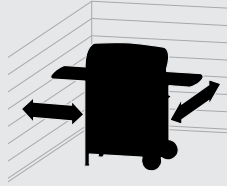

DON'T use in enclosed spaces such as carport, garage, porch or covered patio.

DON'T place barbecue against a wall or other solid structure.

DON'T use this barbecue on a boat or recreational vehicle.

SAFE OPERATION

DO complete a leak-test and safety check before use.

DO check parts before lighting.
DO keep this safety manual with your barbecue for reference.

DO always disconnect the regulator or gas hose before moving the barbecue.

DO turn off all burners and close your barbecue lid if a grease fire occurs. Keep lid closed until the fire is out.

DO turn off the gas source after use.

DON'T leave your barbecue unattended while in operation.

DON'T obstruct the flow of combustion and ventilation air to the barbecue.

DON'T move the barbecue during use.

DON'T attempt to light burner with lid closed. A buildup of non-ignited gas inside a closed barbecue is hazardous.

DON'T block ventilation holes in the sides or back of barbecue.

DON'T use charcoal or ceramic briquettes in this gas barbecue.

DON'T use while under the influence of drugs or alcohol.

DON'T cover barbecue with a cover while still hot or in operation.

DON'T allow children or pets to play anywhere near the barbecue.

DON'T store any spare LP (propane) cylinder, full or empty, under or near your barbecue.

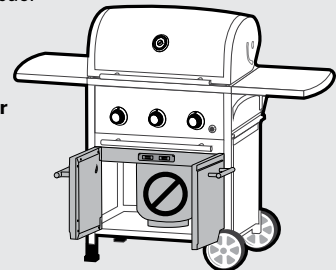

NOTE: INSTALLATION MUST CONFORM WITH LOCAL CODES OR, IN THE ABSENCE OF LOCAL CODES, WITH EITHER THE NATIONAL FUEL GAS CODE, ANSI Z223.1/NFPA 54, NATURAL GAS AND PROPANE INSTALLATION CODE, CSA B149.2, OR PROPANE STORAGE AND HANDLING CODE, ANSI A 119.2/NFPA 1192, AND CSA Z240 RV SERIES, RECREATIONAL VEHICLE CODE, AS APPLICABLE.

CONTACT US: 1-844-586-4660

INSTALLATION

IMPORTANT INFORMATION ABOUT LP GAS & REGULATOR CONNECTIONS

WHAT IS LIQUID PETROLEUM (LP) GAS?

Liquefied petroleum gas, also called LP gas, liquid propane or propane is non toxic, odourless, and colourless when produced. For your safety, LP gas has been given an odour (similar to rotten cabbage) so that it can be detected.

LP gas is highly flammable and may ignite unexpectedly when mixed with air.

LP CYLINDER VALVE REQUIREMENTS:

- LP gas supply cylinder must be constructed and marked in accordance with the specifications for LP gas cylinders of the Canadian Standard for Cylinders, Spheres and Tubes for Transportation of Dangerous Goods and Commission, CAN/CSA-B339; or LP gas Cylinders of the U.S. Department of Transportation (D.O.T), as applicable.
- Propane Cylinder **must not exceed 20 lb (9.1 kg)** capacity, approximately 18¼ inches (46.35 cm) high and 12¼ inches (31.1 cm) in diameter. The LPG capacity is approximately 47 lb 10 oz (21.6 kg) water capacity, or as stated by the manufacturer.
- **Shut-off valve** with a correct cylinder valve output as specified in current standards. ANS Z21.58-2018/CSA1.6-2018 Outdoor Cooking Gas Appliances.
- **Type 1 mating** (CGA 810) compatible with this barbecue. The type 1 valve is easily recognized by the large ACME external threads on the outside of the **valve**.
- **Safety relief valve** with direct connection to the vapour space of the cylinder.
- UL listed **Overfill Protection Device (OPD)**. This OPD safety feature is identified by a unique triangular hand wheel. Use only LP cylinders equipped with this type of valve.
- A device for vapour withdrawal.
- A collar to protect the LP Cylinder **shut-off valve**.
- A ring on the bottom of the LP Cylinder to secure it to the support assembly.
- Equipped with a dust cap for the cylinder **valve** outlet, which must be used whenever the cylinder is not in use.
- Cylinders must have a **D.O.T. certification (A)**, and a testing date (B) that is within five years of current use.

LP CYLINDER INSPECTION

1. Confirm that the Cylinder shut-off valve is fully closed, by turning clockwise (see image A).
2. Confirm that the Cylinder valve is the proper Type 1 mating (see image B).
3. Inspect the Cylinder valve, including the internal rubber seal for damage or debris (see image C).
If damaged, return Cylinder to local retailer.

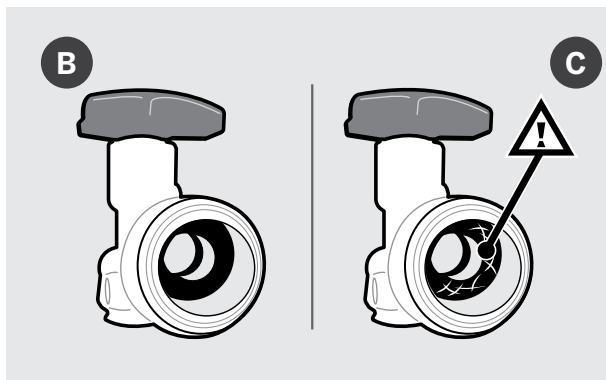
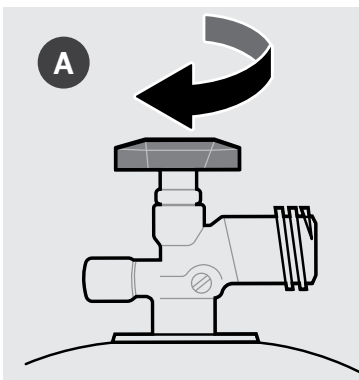

INSTALLATION

REGULATOR AND LP CYLINDER INSTALLATION

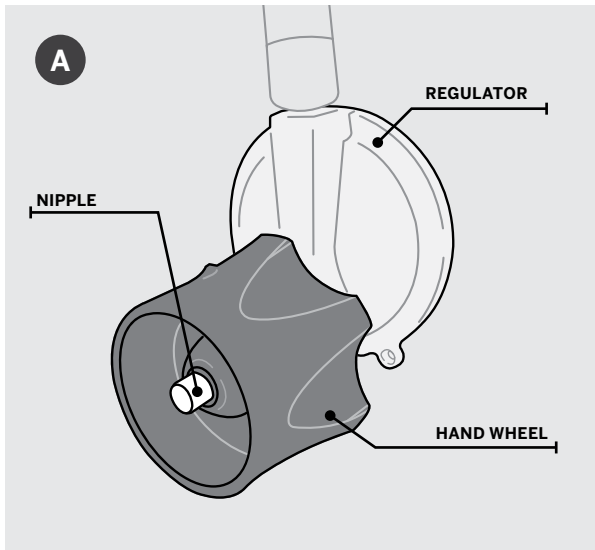

PRESSURE REGULATOR (See image A)

This barbecue is designed to operate on LP gas at a pressure of 2.74 kPa (11" water column). A regulator preset to this pressure is supplied with your barbecue. Replacement regulators must be as specified by Vermont Castings™ (UL-listed Type 1 (CGA 810) Cylinder connection device as described in the latest edition of ANSI Z21.81).

SAFETY FEATURES

All Vermont Castings™ barbecues are designed to be used with an LP gas cylinder equipped with the new QCC-1 Quick Closing Coupling system, which includes the following safety features required by the Canadian Standards Steering Committee and the American National Standards Institute(ANSI):

- Gas will not flow until a positive connection has been made.
- A thermal element built into the regulator will shut the flow of gas between 240°- 300°F (115°- 149°C).
- When activated, a Flow Limiting Device will restrict the flow of gas to 10 cubic feet per hour. **See Regulator Flow Limiting Device Activated (PAGE 11).**

INSTALLATION

REGULATOR AND LP CYLINDER INSTALLATION

THIS BARBECUE COMES EQUIPPED WITH AN EASY ACCESS, EXTERIOR CYLINDER MOUNT, LOCATED UNDER THE RIGHT-SIDE SHELF TABLE.

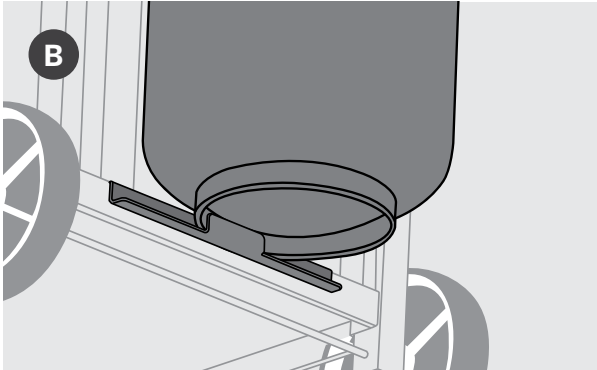

1. Check that all burner control knobs are in the "OFF" position, by pushing in and turning knobs clockwise.
2. Ensure LP Cylinder is in the "OFF" position by turning the safety shut-off valve clockwise to a full stop.
3. Loosen wing nut on Cylinder bracket.
4. Lift Cylinder into position onto the base support (see image B).

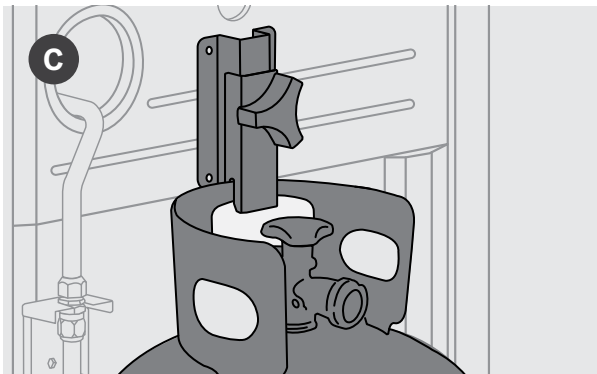

NOTE: WHEN CORRECTLY POSITIONED, THE LP CYLINDER CHECK VALVE SHOULD FACE RIGHT (see image C).

5. Position Cylinder support bracket over the Cylinder collar. Tighten wing nut (see image C).
6. Remove the protective cap from the LP cylinder check valve.

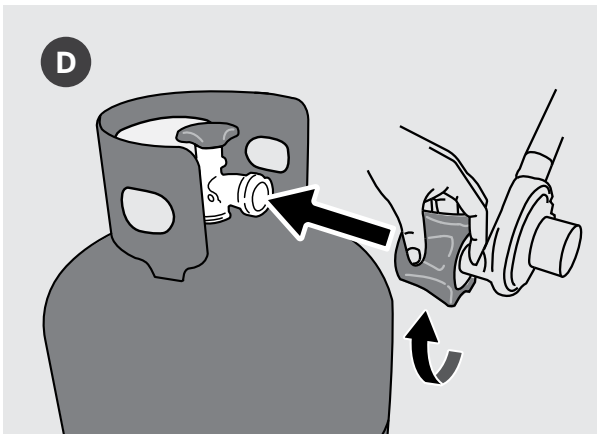

7. Connect the Type 1 regulator coupling to the cylinder valve, turning clockwise (see image D). Hold the regulator in a straight line with the LP cylinder when connecting. **Hand-tighten only. Proceed to CHECKING FOR GAS LEAKS, Page 10.**

ATTENTION: GAS REGULATORS ARE DESIGNED TO BE ATTACHED AND DETACHED FROM GAS CYLINDERS BY HAND. NEVER TIGHTEN OR LOOSEN THE REGULATOR USING A WRENCH, AS DAMAGE TO THE REGULATOR OR CYLINDER CAN RESULT.

INSTALLATION

CHECKING FOR GAS LEAKS

ATTENTION: LEAK TEST MUST BE REPEATED EACH TIME THE LP CYLINDER IS EXCHANGED OR REFILLED.

All factory assembled connections have been thoroughly checked for gas leaks and the burners checked for proper combustion and flame characteristics. Always perform a thorough Leak Check following assembly, installation of a new cylinder, and on an annual basis.

LEAK TESTING THE LP CYLINDER, HOSE & REGULATOR AND MANIFOLD CONNECTIONS

BEFORE YOU BEGIN:

1. You will need a paint brush OR spray bottle with a mild soap (20%) and water (80%) solution.
2. Turn all grill control knobs to "OFF".
3. Ensure that the regulator is tightly connected to LP cylinder.

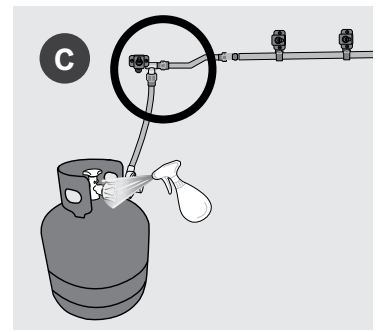
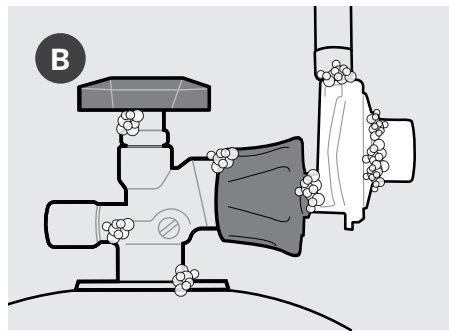
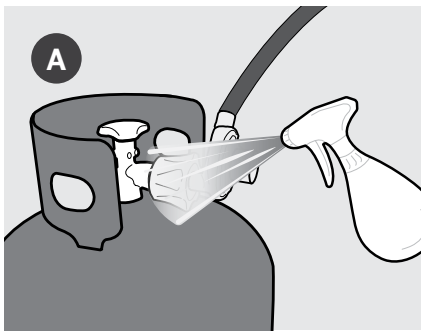

LEAK TEST:

1. Brush or spray soapy solution onto all connections shown (see image A).
2. Slowly open LP cylinder shut-off valve by turning hand wheel counterclockwise, while checking for bubbles.

CAUTION: IF YOU HEAR A RUSHING SOUND, TURN GAS OFF IMMEDIATELY. THERE IS A LEAK AT THE CONNECTION. CORRECT BEFORE PROCEEDING.

3. If "growing" bubbles appear, there is a leak.
 - a. If the leak is at the cylinder (see image B), turn cylinder shut-off valve clockwise to the "CLOSED" position. DO NOT OPERATE THE BARBECUE. Disconnect the cylinder and return the cylinder to your local retailer.
 - b. If the leak is at the regulator or manifold connections (see image C), turn cylinder shut-off valve clockwise to the "CLOSED" position. Re-tighten connections and repeat steps 1 and 2.
 - c. If leaks cannot be stopped do not try to repair. Call for replacement parts. Order new parts by contacting Vermont Castings™ Customer Care 1-844-586-4660.
4. If bubbles do not appear, leak check is complete. Turn the LP cylinder shut-off valve clockwise to close.

NOTE: SOME LEAK TEST SOLUTIONS MAY BE SLIGHTLY CORROSIVE, ALL CONNECTIONS SHOULD BE RINSED WITH WATER AFTER CHECKING FOR LEAKS.

CAUTION: A FROSTY REGULATOR INDICATES GAS OVERFILL. IMMEDIATELY CLOSE LP CYLINDER VALVE AND CALL LOCAL LP GAS DEALER FOR ASSISTANCE.

WARNING: DO NOT SMOKE DURING LEAK TEST.

DO NOT USE AN OPEN FLAME TO CHECK FOR GAS LEAKS.

BARBECUE MUST BE LEAK TESTED OUTDOORS IN A WELL-VENTILATED AREA, AWAY FROM IGNITION SOURCES. DURING LEAK TEST, KEEP YOUR BARBECUE AWAY FROM OPEN FLAMES OR SPARKS.

CAUTION: IF IT IS EVIDENT THERE IS EXCESSIVE ABRASION OR WEAR, OR THE HOSE IS CUT, IT MUST BE REPLACED PRIOR TO THE BARBECUE BEING PUT INTO OPERATION. THE REPLACEMENT HOSE ASSEMBLY SHALL BE THAT SPECIFIED BY THE MANUFACTURER.

CONTACT US: 1-844-586-4660

INSTALLATION

REGULATOR FLOW LIMITING DEVICE ACTIVATED (PROPANE MODELS)

If you are experiencing any of the following performance issues, you may have activated the flow limiting feature in your regulator:

- Burners not getting hot enough.
- Low or incomplete burner flames.
- Low gas pressure.
- Difficulty lighting all burners or burners not staying lit.

RESETTING THE REGULATOR FLOW LIMITING FEATURE (PROPANE BARBECUES):

1. With all control knobs in the "CLOSED" position, and the cylinder shut-off valve in the "CLOSED" position, open the barbecue lid.
2. Disconnect the regulator from the LP cylinder.
3. Turn all control knobs to the "HIGH" position, and let stand for 1-3 minutes, allowing all excess gas in the gas manifold to dissipate.
4. Turn all control knobs back to the "OFF" position.
5. With the barbecue lid still OPEN, reconnect the regulator to the LP cylinder. Do not cross thread the connection. Hand-tighten only.
6. Check all connections to ensure that a positive seal has been made.
7. **Slowly** open the LP cylinder shut-off valve.

NOTE: IF THE LP CYLINDER IS OPENED TOO QUICKLY, THE FLOW LIMITING DEVICE IN THE REGULATOR WILL ACTIVATE, LIMITING THE FLOW OF GAS FROM THE LP CYLINDER.

8. Wait approximately 30 seconds for the regulator pressure to stabilize.
9. Turn the first control knob to the "HIGH" position.
10. Press the Electronic ignition button, or use the match and match holder, or a barbecue lighter to ignite the burner.

NOTE: AVOID ACTIVATING THE FLOW LIMITING FEATURE IN THE REGULATOR BY FOLLOWING THE PROPER LIGHTING AND SHUT DOWN PROCEDURES AND PERFORMING A COMPLETE LEAK TEST AND SAFETY CHECK TO ENSURE THAT THERE ARE NO LEAKS IN THE SYSTEM.

REMOVING THE CYLINDER:

Before disconnecting the LP cylinder:

1. Turn "OFF" all control knobs and close the LP cylinder shut-off valve.
 2. Turn the regulator coupling nut counterclockwise by hand only - do not use tools to disconnect.
 3. Install safety cap onto LP cylinder check valve. Always use cap supplied with cylinder.
- Failure to use safety cap as directed may result in serious personal injury and/or property damage.

REFILLING THE LP CYLINDER:

- Use only licensed and experienced dealers.
- Ensure that the dealer checks and tests the cylinder for leaks after filling.
- LP dealer must purge new cylinder before filling.
- Dealer should NEVER fill LP cylinder more than 80% of LP cylinder volume. Volume of propane in cylinder will vary by temperature.
- Do not release liquid propane (LP) gas into the atmosphere. This is a hazardous practice.
- To remove gas from LP cylinder, return to the licensed dealer.
- Never refill an expired or unregulated cylinder.
- Never connect an unregulated or expired cylinder to this barbecue.

INSTALLATION

STORAGE & HANDLING LP CYLINDER

WARNINGS:

- ALTHOUGH YOUR LIQUID PROPANE CYLINDER MAY APPEAR TO BE EMPTY, GAS MAY STILL BE PRESENT, AND THE CYLINDER SHOULD BE TRANSPORTED AND STORED ACCORDINGLY, WITH THE SHUT-OFF VALVE IN THE "CLOSED" POSITION.
- WHEN TRANSPORTING AND STORING THE CYLINDER, MAKE SURE IT IS IN AN UPRIGHT POSITION (NOT ON ITS SIDE) AND SECURE.
- NEVER EXPOSE THE CYLINDER TO DIRECT SUNLIGHT OR EXCESSIVE HEAT, WHERE TEMPERATURES CAN REACH 125° F (51.7° C).
- DO NOT SMOKE AROUND CYLINDER, ESPECIALLY WHEN TRANSPORTING IN A VEHICLE.
- A DENTED OR RUSTY CYLINDER MAY BE HAZARDOUS AND SHOULD BE CHECKED BY YOUR PROPANE SUPPLIER.
- LP CYLINDERS MUST ALWAYS BE HANDLED WITH EXTREME CARE.
- PLACE DUST CAP ON CYLINDER CHECK VALVE WHENEVER THE CYLINDER IS NOT IN USE.
- DO NOT STORE AN LP CYLINDER IN ENCLOSED SPACES SUCH AS A CARPORT, GARAGE, PORCH, COVERED PATIO OR OTHER BUILDING. MAKE SURE THE STORAGE AREA HAS A LOT OF VENTILATION.
- DO NOT STORE AN LP CYLINDER IN AN AREA WHERE CHILDREN PLAY.
- AN OVER FILLED OR IMPROPERLY STORED CYLINDER IS A HAZARD DUE TO POSSIBLE GAS RELEASE FROM THE SAFETY RELIEF VALVE. THIS COULD CAUSE AN INTENSE FIRE OR EXPLOSION WITH RISK OF PROPERTY DAMAGE, SERIOUS INJURY OR DEATH.

WARNING: IF THE ABOVE INSTRUCTIONS ARE NOT COMPLETELY ADHERED TO, IT COULD CAUSE A FIRE/EXPLOSION, RESULTING IN DEATH OR SERIOUS INJURY, OR PROPERTY DAMAGE.

DANGER: ALWAYS TURN THE LP CYLINDER SHUT-OFF VALVE TO "CLOSE" WHEN THE BARBECUE IS NOT IN USE. NEVER STORE A SPARE LP CYLINDER, EMPTY OR FULL, INSIDE THE BARBECUE CART OR NEAR THE BARBECUE. IF YOU SEE, SMELL OR HEAR GAS ESCAPING, IMMEDIATELY GET AWAY FROM THE LP CYLINDER/BARBECUE AND CALL YOUR FIRE DEPARTMENT.

DO NOT INSERT ANY TOOL OR FOREIGN OBJECT INTO THE VALVE OUTLET OR SAFETY RELIEF VALVE. YOU MAY DAMAGE THE VALVE AND CAUSE A LEAK. LEAKING PROPANE MAY RESULT IN EXPLOSION, FIRE, SEVERE PERSONAL INJURY, OR DEATH.

NATURAL GAS REQUIREMENTS

- Consult a Certified Gas Technician to ensure that the home supply line is suitable for a 3/8" natural gas supply line, capable of an input of up to 85,000 BTUs.
- All gas supply plumbing must be carried out by a Certified Gas Technician, in accordance with provincial authorities having jurisdiction, and in accordance with CAN/CGA 1-B149.1 & 2 installation code requirements.
- **A shut-off valve** must be installed between the barbecue and the natural gas supply line.
- When conducting pressure test always isolate the barbecue from the gas supply piping system by disconnecting the barbecue and closing its individual manual shutoff valve.
- The gas supply piping system should be tested at pressures which exceed 1/2 psi (3.5kPa).
- All gas supply plumbing must be able to supply 7" water column to the barbecue WITH ALL BURNERS IN OPERATION.

CONTACT US: 1-844-586-4660

INSTALLATION

NATURAL GAS REQUIREMENTS



CONVERTIBLE VALVE SYSTEM™

For your convenience all Vermont Castings™ Models include the Convertible Valve System™, which makes converting your barbecue from Propane to Natural Gas simple. **NOTE: YOU WILL NEED A CONVERTIBLE VALVE SYSTEM KIT—Sold Separately (Model 85-2261-4).**

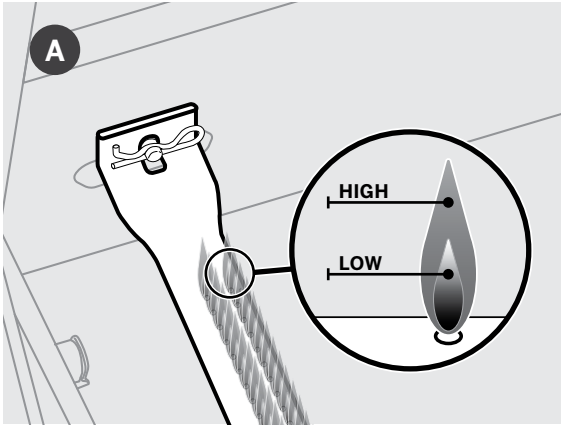

NATURAL GAS BURNER FLAME CHECK

The burner flame pattern is the key indicator of proper or improper function within the cook system. When the burners are performing correctly you will see a specific flame pattern. All burner ports should be 2.5 cm/ 1" flame on "HIGH" with orange tips, light blue center, with a darker blue flame at the base of the burner port (see image A).

PERFORMANCE ISSUES: IF YOU ARE EXPERIENCING ANY OF THE FOLLOWING

- Large, unruly, or irregular orange burner flames.
- The smell of gas in conjunction with irregular flames.
- Low temperatures or uneven heat.

SHUT DOWN YOUR BARBECUE AND PERFORM A LEAK TEST. IF A LEAK IS NOT DETECTED, ENSURE THAT YOU ARE FOLLOWING THE PROPER LIGHTING INSTRUCTIONS ON PAGE 14.

CONNECTING YOUR BARBECUE TO THE NATURAL GAS SOURCE.

Coat pipe nipple with gas-resistant teflon tape or pipe dope.

Tighten quick-disconnect coupling onto pipe nipple that leads to natural gas supply (see image B).

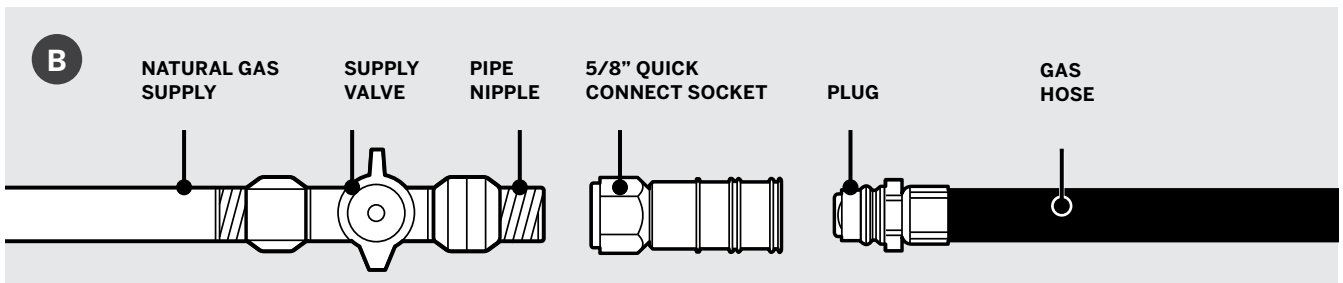

With the natural gas supply valve "OFF", connect the natural gas hose to the quick connect socket. Push the sleeve back on the quick connect socket (see image C) and insert the plug until the sleeve snaps forward, locking the plug into the quick connect socket. Be sure to leak test these connections prior to use.

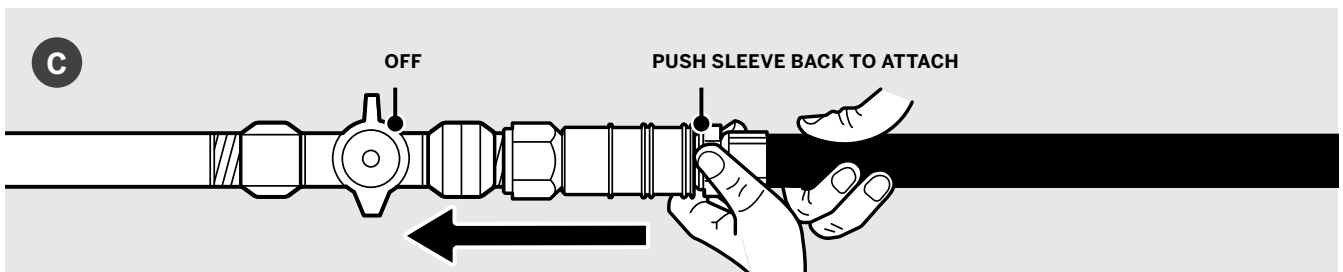

FIRE HAZARD: DO NOT ROUTE THE NATURAL GAS HOSE INSIDE OF THE BARBECUE CART.

GET ACQUAINTED

OPERATION - LIGHTING INSTRUCTIONS

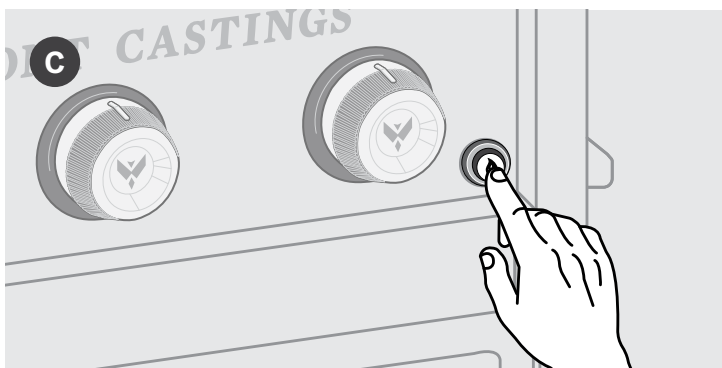
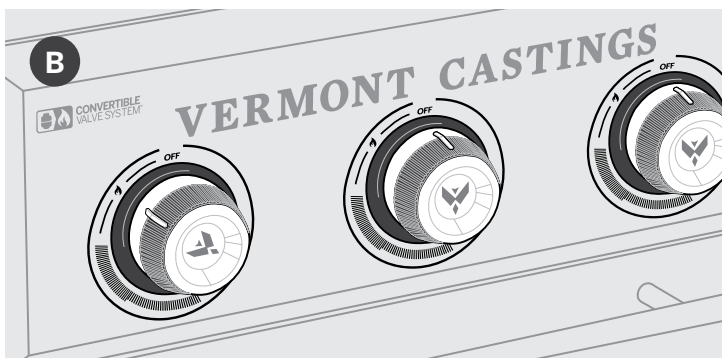
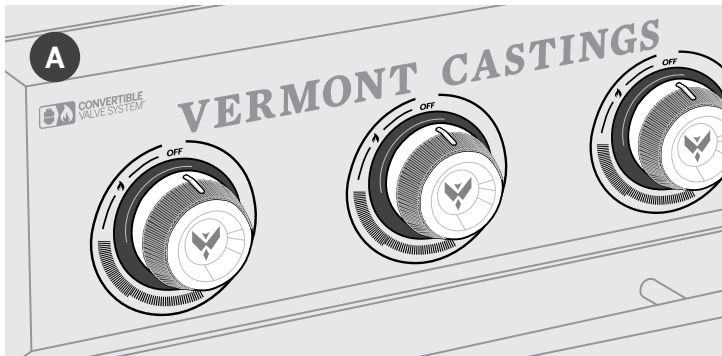

LIGHT IT WITH THE IGNITION SYSTEM

Each burner is equipped with its own control knob and ignites independently. Ignite the burners from Left to Right.

1. Open the lid.
2. Check that all burner control knobs are in the "OFF" position by pushing in and turn all knobs clockwise (see image A).

ATTENTION: ALL BURNER CONTROL KNOBS MUST BE IN THE "OFF" POSITION BEFORE OPENING THE LP CYLINDER SHUT-OFF VALVE. IF ALL CONTROL KNOBS ARE NOT "OFF" THE FLOW LIMITING DEVICE IN THE REGULATOR WILL BE ACTIVATED, LIMITING THE FLOW OF GAS TO THE GRILL.

3. SLOWLY, turn the LP cylinder shut-off valve counter clockwise. Wait 30 seconds for pressure to stabilize.

ATTENTION: IF THE LP CYLINDER SHUT-OFF VALVE IS OPENED TOO QUICKLY, THE FLOW LIMITING DEVICE IN THE REGULATOR MAY BE ACTIVATED, LIMITING THE FLOW OF GAS TO THE GRILL.

4. Light the far left burner first. Push in and turn the control knob counterclockwise to the Ignite/High (🔥) position (see image B).
5. Push and hold the Electronic Ignition Button (see image C). You will hear a clicking sound.
6. Check that the burner is lit by looking through the cooking grates or look through the hole in the side of the burner box, located under the side shelf.
7. If the burner lights correctly, repeat steps 4 through 6 to light the remaining burners.
8. If the burner does not light, turn the burner control knob to the "OFF" position and wait 5 minutes to allow the gas to clear before attempting to light again.
9. For issues lighting with the Electronic Ignition button, see Troubleshooting section for a resolution, or follow the match lighting procedure.

WARNING: THE BURNER CONTROL KNOBS MUST BE IN THE "OFF" POSITION BEFORE TURNING ON THE LIQUID PROPANE CYLINDER TANK VALVE. IF LEFT IN THE "ON" POSITION, WHEN THE LP CYLINDER VALVE IS OPENED, THE "FLOW LIMITING DEVICE" FEATURE WILL ACTIVATE, LIMITING THE FLOW OF GAS FROM THE LP CYLINDER. IF THIS SHOULD OCCUR, TURN "OFF" THE LP CYLINDER VALVE AND BURNER CONTROL KNOBS AND FOLLOW THE "RESETTING THE FLOW LIMITING DEVICE INSTRUCTIONS".

WARNING: NEVER STAND WITH YOUR HEAD DIRECTLY OVER THE BARBECUE WHEN PREPARING TO LIGHT THE MAIN BURNERS, TO PREVENT POSSIBLE BODILY INJURY.

OPERATION

LIGHTING THE BARBECUE

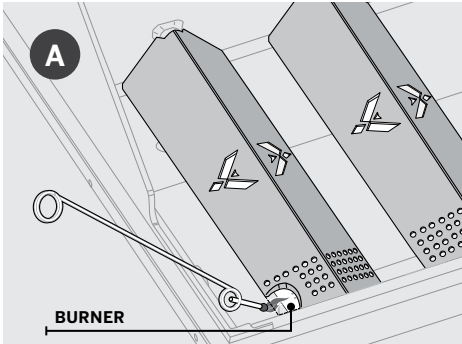

LIGHTING WITH A MATCH OR BARBECUE LIGHTER

1. Open the lid.
2. Check that all burner control knobs are in the "OFF" position by pushing in and turning all knobs clockwise.
3. SLOWLY, turn the LP cylinder shut-off valve counterclockwise. Wait 30 seconds for pressure to stabilize.

ATTENTION: ALL BURNER CONTROL KNOBS MUST BE IN THE "OFF" POSITION BEFORE OPENING THE LP CYLINDER SHUT-OFF VALVE. IF ALL CONTROL KNOBS ARE NOT "OFF" THE FLOW LIMITING DEVICE IN THE REGULATOR WILL BE ACTIVATED, LIMITING THE FLOW OF GAS TO THE GRILL.

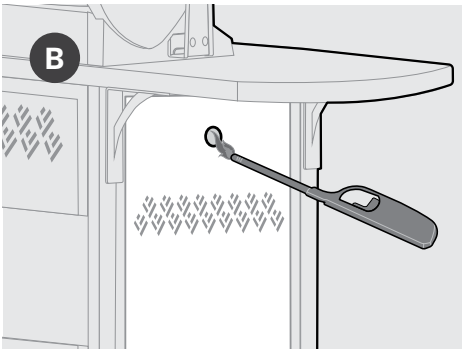

4. To match light the far-left burner first, push in and turn the control knob counterclockwise to the Ignite/High (🔥) position.
5. Position a barbecue lighter or a match inserted into the match holder provided with your barbecue, through the lighting hole on the left side of the burner box (see image B) or through the cooking grates (see image A). Check to ensure the burner is lit.
6. Repeat steps 4 and 5 for the remaining burners.

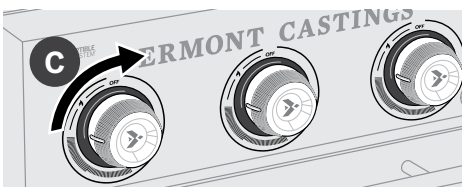

SHUT DOWN PROCEDURE

1. Push in and turn each control knob clockwise to the "OFF" position (see image C).

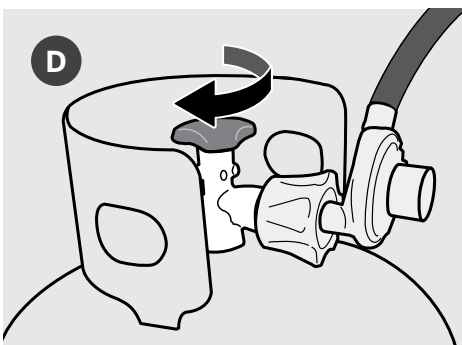

2. Turn LP cylinder shut-off valve clockwise to close (see image D).

OPERATION

LIGHTING THE BARBECUE

LIGHTING THE SIDE BURNER (IF APPLICABLE)

1. Open the side burner lid.
2. Check that the side burner control knob is turned "OFF".
3. Slowly, turn the LP cylinder shut-off valve counterclockwise to open. Wait for pressure to stabilize.
4. Push in and turn the side burner knob to the "MAX" position.
5. Push and hold the Electronic Ignition Button. You will hear a clicking sound.
6. Check that the burner is lit. If the burner fails to light properly within 3-5 seconds, turn the burner control knob "OFF". Wait five minutes before attempting to light again. This will allow time for the released gas to disperse.

CAUTION: THE SIDE BURNER FLAME IS DIFFICULT TO SEE IN DAYLIGHT. THE SIDE BURNER LID IS FOR STORAGE, CLOSE ONLY AFTER THE SIDE BURNER HAS COOLED.

LIGHTING THE INFRARED SIDE BURNER (IF APPLICABLE)

1. Open the Infrared Side Burner lid.
2. Check that the Infrared Side Burner knob is turned "OFF".
3. Slowly, turn the LP cylinder shut-off valve counterclockwise to open. Wait for pressure to stabilize.
4. Push in and turn the Infrared Side Burner control knob to the "MAX" position .
5. Push and hold the Electronic Ignition Button. You will hear a clicking sound.
6. Check that the burner is lit. If the burner fails to light properly within 3-5 seconds, turn the burner control knob "OFF". Wait five minutes before attempting to light again. This will allow time for the released gas to disperse.

CAUTION: SIDE BURNER FLAME MAY BE DIFFICULT TO SEE ON A BRIGHT SUNNY DAY. THE INFRARED SIDE BURNER LID IS FOR STORAGE, CLOSE ONLY AFTER THE INFRARED SIDE BURNER HAS COOLED.

ATTENTION: NOT FOLLOWING CORRECT LIGHTING AND SHUT DOWN PROCEDURE CAN ACTIVATE THE FLOW LIMITING DEVICE IN THE REGULATOR.

RESOLVING IGNITION ISSUES

RESOLVING IGNITION ISSUES

QUICK CHECK:

Press the ignition button located on the right side of the control panel (see image A). You should hear a continuous clicking sound when the button is pressed. If you hear no sound, 1) replace the battery (see image B), 2) check that all wires are firmly pushed in (see image C).

Tip: When checking the wires there are two common trouble spots to pay attention to:

1. The ignition wires on the back of the control panel mounted ignition button.
2. The ignition wires connected to the Electronic ignition module located inside the barbecue cabinet.

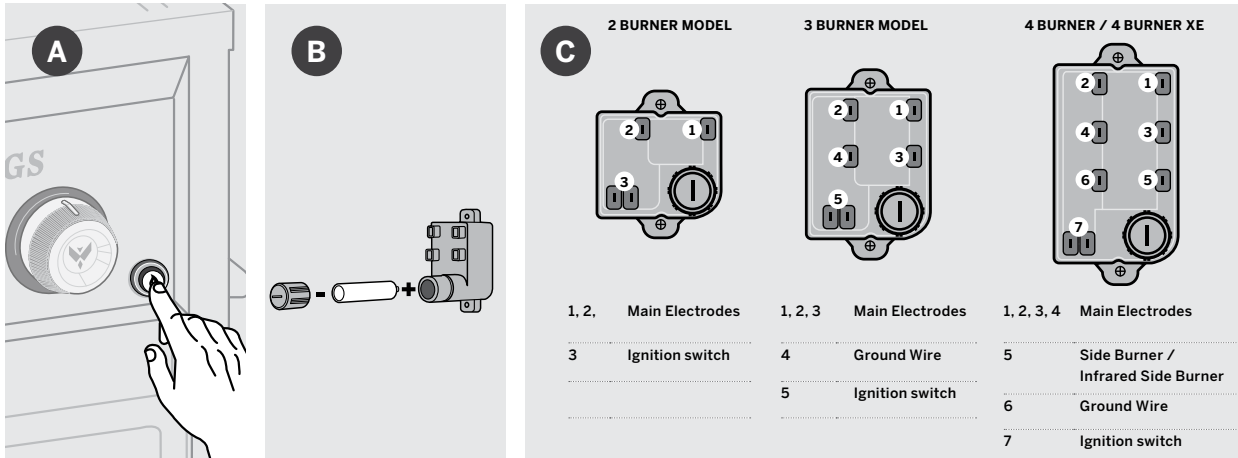

ATTENTION: ONCE LIT, CONFIRM THAT THE BURNER IS PROPERLY LIT AND THAT THE FLAME PATTERN IS AS DESIRED. IF THE FLAME PATTERN IS OTHER THAN NORMAL, CONSULT THE TROUBLESHOOTING GUIDE FOR CORRECTIVE ACTION.

BATTERY CARE, USE AND DISPOSAL

- DO start by positioning a brand new battery in your Electronic Ignition Module.
- DO remove the battery from the Electronic Ignition Module during storage periods.
- DO recycle or dispose of batteries properly, as per the requirements of your local municipality.
- DO NOT submerge the Electronic Ignition Module in water.
- DO NOT leave the batteries where a child or pet could play with or swallow them.

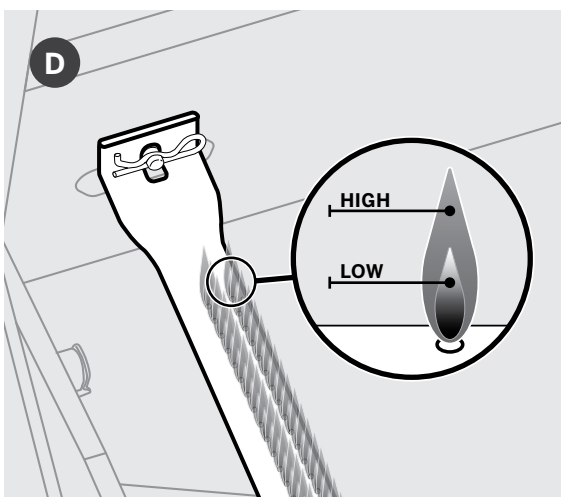

PROPER BURNER FLAME PATTERN

The burner flame pattern is the key indicator of proper or improper function within the cook system. When the burners are performing correctly you will see a specific flame pattern. All burner ports should be 2.5 cm/ 1" flame on "HIGH" with orange tips, light blue center, with a darker blue flame at the base of the burner port (see image D).

Refer to the Troubleshooting section on page 26–27 if you experience any of the following issues:

- Large, unruly, or irregular orange burner flames.
- The smell of gas in conjunction with irregular flames.
- Low temperatures or uneven heat.

FOLLOW THE BURNER CLEANING PROCEDURE OUTLINED IN THE MAINTENANCE SECTION (PAGE 23) OF THIS MANUAL OR FOLLOW THE REGULATOR FLOW LIMITING DEVICE RESET (PAGE 11).

RESOLVING IGNITION ISSUES

RESOLVING IGNITION ISSUES

BLOCKED BURNER VENTURI

Blockages in the burner venturi caused by spiders, insects and nests can cause a FLASHBACK FIRE.

A flashback fire occurs when a blockage in the venturi tubes caused by spiders, insects and nests blocks the flow of gas, forcing it back towards the control panel and control knob. The ignited gas, if not detected, can cause a fire to burn in this area. **IF YOU EXPERIENCE ANY OF THE CHARACTERISTICS OF A FLASHBACK FIRE. CLOSE THE LP CYLINDER SHUT-OFF IMMEDIATELY. FOLLOW THE BURNER CLEANING PROCEDURE OUTLINED IN THE MAINTENANCE SECTION OF THIS MANUAL.**

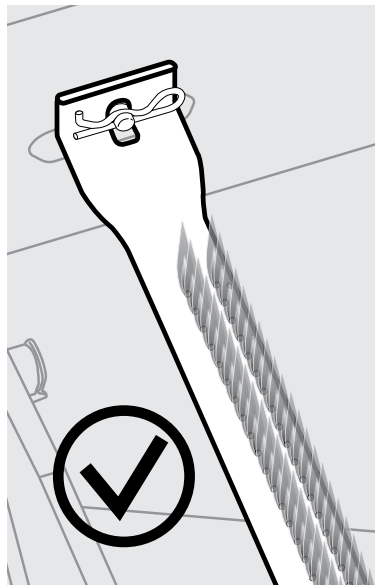
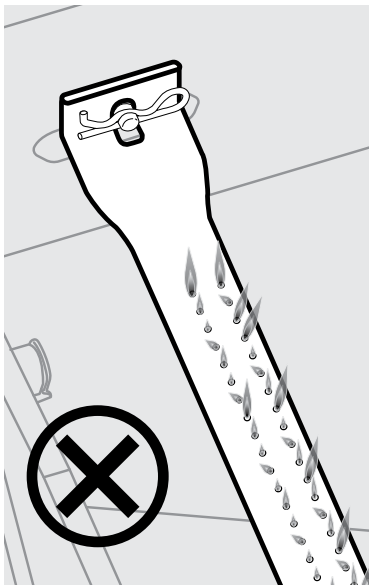
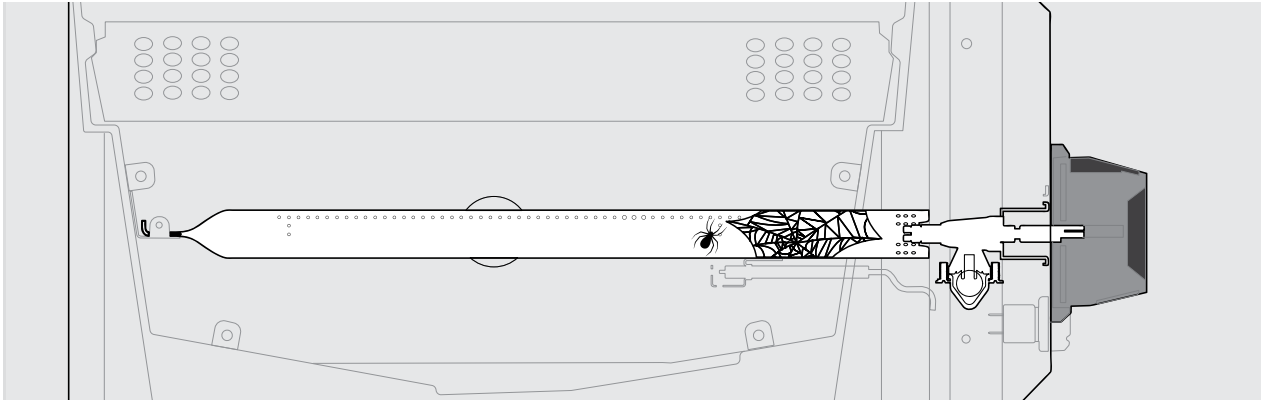

CHARACTERISTICS OF A FLASHBACK FIRE

- A fire burning outside of the cookbox, usually visible behind or under the control panel.
- Hot or melting control knobs.
- Large yellow, unruly flames accompanied by the smell of gas.
- Burners not lighting correctly, or partially lighting.

WARNING: AT FIRST SIGHT OF YELLOW, UNRULY FLAMES, POORLY LIT BURNERS ACCOMPANIED BY THE SMELL OF GAS, SHUT DOWN YOUR GRILL, AND PERFORM BURNER CLEANING MAINTENANCE, OUTLINED IN THE MAINTENANCE SECTION OF THIS MANUAL (PAGE 23).

TIPS AND BEST PRACTICES



GRILLING TIPS

FOOD PREPARATION

- Avoid cross-contamination when preparing food. Always use separate plates and utensils for the handling of raw food. Never place raw food and cooked food on the same plate, and never place cooked food on a plate that was used for handling raw food. Always carefully wash all plates and utensils used to handle raw food before using them to handle cooked food.
- Sanitize counters, equipment and utensils after handling raw meat, seafood or poultry.
- Always wash all vegetables, seafood and poultry before cooking.
- Always leave uncooked foods in the refrigerator until you are ready to start cooking.
- Always marinate meat in the refrigerator. Always dispose of the excess marinade, and never reuse it.
- Trim excess fat from meats and slit the remaining fat at two-inch increments to avoid flare-ups and curling.
- Meats must be adequately thawed before placing onto the grills cook surface.

PREPARING YOUR BARBECUE

- First things first, always preheat your barbecue on "HIGH" for 10 minutes, 15 minutes in extreme cold temperatures, with the lid closed.
- During preheat, brush away any leftover grease and build-up, leftover from the previous cook.
- Apply a light coating of cooking oil on your cooking grates before grilling, to prevent foods from sticking.
- If your cooking grates appear dry, it's time to re-season with vegetable shortening. Ensure that all corners, top and bottom are coated.
- If you notice black grease build-up, turn your barbecue to "HIGH" and burn off the excess grease.

GRILLING TIPS

- Following preheat, adjust temperatures down to medium for most foods.
- Preserve barbecue temperatures by keeping the barbecue lid closed during cooking.
- Cook similar portion sizes together, so that they all cook evenly.
- Thaw meats before placing on cooking surface. Placing frozen meats on the cook surface can permanently damage cooking surface.
- Never pierce foods during cooking, as you will lose flavour and juices.
- Turn foods only once, halfway through the cooking cycle. You will notice clear juices on the surface of the meat when it's ready to flip.
- If you are trying to turn foods and they are sticking, either they are not ready to turn, or your cook surface requires re-seasoning. For a quick fix, add some cooking oil to your spatula and turn foods.
- Fatty meats may be cooked indirectly on lower heat settings.
- Always use a meat thermometer to check doneness. Undercooked foods can retain bacteria, especially if thawed or exposed to warm conditions prior to cooking.
- Apply salt only after cooking to prevent drying out the meat.
- Baste meat with barbecue sauce or other sugar-based sauces only during the last few minutes of cooking to prevent burning.

TIPS AND BEST PRACTICES

GRILLING TIPS

USING YOUR SIDE BURNER (IF APPLICABLE)

- Your side burner will boil, sauté, stir fry and warm with ease.
- For best results preheat your side burner for 10-15 minutes on "HIGH (🔥)".
- Your side burner will take longer to preheat and cook than your indoor range. When boiling water or warming foods always ensure that you are using a covered pot or wok.
- Ensure that your gas barbecue is positioned away from high winds or cold air as this will adversely affect your side burner preheat times and cooking performance.
- Inspect and clean your side burner orifice periodically and confirm that it is clear of food residue, cobwebs or other insect debris that may cause a **FLASH BACK FIRE**.

WARNING: YOUR SIDE BURNER LID IS FOR STORAGE ONLY AFTER THE BURNER HAS COOLED.

USING YOUR INFRARED SIDE BURNER (IF APPLICABLE)

- Always wear protective gloves when using this high intensity infrared zone side burner.
- Always keep children, pets and guests away from this side burner when in operation.
- The infrared side burner lid is for **STORAGE ONLY**. Only close after burner has cooled.
- This infrared side burner is temperature adjustable. Only use the "HIGH (🔥)" setting during preheat and for searing foods. Avoid overcooking foods by adjusting the burner control knob to a lower setting.

WARNING: DUE TO THE INTENSE HEAT OF THE INFRARED SIDE BURNER, FOOD LEFT UNATTENDED OVER BURNER, WILL BURN QUICKLY.

- The infrared burners of your barbecue are designed to provide a long service life. Follow these steps to prevent cracking of the ceramic surface, which will cause the burner to malfunction.
- Do not allow hard objects to impact the infrared burner.
- Do not allow water (rain, sprinkler, hose, etc.) to come in contact with the hot infrared burner. A large temperature differential can cause cracking of the ceramic tiles.
- Keep the lid closed when the infrared side burner is not in use.
- After cooking operate the burner on "HIGH (🔥)" for 5 minutes, to burn off any drippings and debris.
- **DAMAGE CAUSED BY FAILURE TO FOLLOW THESE STEPS IS NOT COVERED BY YOUR BARBECUE WARRANTY.**

GRILLING GUIDE

TEMPERATURE TIPS



⚠️ WARNING ⚠️

TO ENSURE THAT IT IS SAFE TO EAT, FOOD MUST BE COOKED TO THE MINIMUM INTERNAL TEMPERATURES LISTED IN THE TABLE BELOW.



AAFC* SAFE MINIMUM INTERNAL TEMPERATURES

Fish	145° F (63° C)
Pork	160° F (71° C)
Egg Dishes	160° F (71° C)
Steaks and Roasts of Beef, Veal or Lamb	145° F (63° C)
Ground Beef, Veal or Lamb	160° F (71° C)
Whole Poultry (Turkey, Chicken, Duck, etc.)	165° F (74° C)
Ground or Pieces Poultry (Chicken Breast, etc.)	165° F (74° C)

* Agriculture and Agri-Food Canada



WARNING: TO ENSURE THAT IT IS SAFE TO EAT, FOOD MUST BE COOKED TO THE MINIMUM INTERNAL TEMPERATURES LISTED IN THE TABLE ABOVE. AAFC* SAFE MINIMUM INTERNAL TEMPERATURES FISH 145° F (63° C), PORK 160° F (71° C), EGG DISHES 160° F (71° C), STEAKS AND ROASTS OF BEEF, VEAL OR LAMB 145° F (63° C), GROUND BEEF, VEAL OR LAMB 160° F (71° C), WHOLE POULTRY (TURKEY, CHICKEN, DUCK, ETC.) 165° F (74° C), GROUND OR PIECES POULTRY (CHICKEN BREAST, ETC.) 165° F (74° C).

SEASONING INSTRUCTIONS

SEASONING COOKING GRATES

Seasoning your porcelain-coated cast iron cooking grates are critical to ensuring a long life and optimal performance for your barbecue. Seasoning will permeate the pores of your cooking grates, creating a non-stick surface, better performance and optimal protection against moisture and water damage, keeping rust and deterioration away.

TOOLS REQUIRED



Rubber gloves

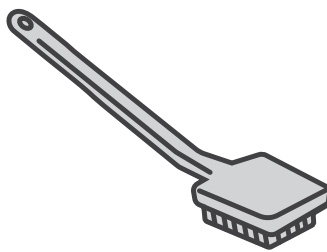

Grill brush



Oil

HOW TO SEASON YOUR COOKING GRATES

1. Brush away any build-up with a grill brush.
2. Perform a burn-off on "HIGH" temperature for 10-15 minutes to incinerate any residual grease build-up.
3. Shut down your barbecue and let it cool with the lid open.
4. Once cooled, remove and inspect your cooking grates. Scrape any remaining debris from the top and bottom of the grates.

CAUTION: DO NOT HANDLE PARTS UNTIL THE BARBECUE HAS COMPLETELY COOLED.

SEASONING INSTRUCTIONS

HOW TO SEASON YOUR COOKING GRATES – CONTINUED

5. Wash cooking grates with soap and water.
6. Rinse and dry thoroughly with a towel or dry in the sun.

IMPORTANT: NEVER ALLOW YOUR COOKING GRATES TO SOAK IN WATER OR STAY WET. THE COOKING GRATES MUST BE COMPLETELY DRY BEFORE SEASONING.

7. Using a pair of rubber gloves, coat your cooking grates top, bottom, sides and each rod with your choice of **vegetable shortening, canola oil, vegetable oil or peanut oil**. DO NOT use salted fat such as margarine, butter, or any non-stick cooking spray. Do not use olive oil as it burns off at high temperatures.
8. Place your porcelain-coated cast iron cooking grates in your barbecue for up to 20 minutes, with your controls set to "MED-LOW" heat (250-300°F).
9. **Alternative Conventional Oven Instructions:** Place your cooking grates in your conventional oven on top of aluminum foil or a cookie sheet, for up to 20 minutes, at 250-300°F.
10. Following the seasoning process, **the cooking grates must be allowed to cool down completely before use.**

SEASONING TIPS:

- Canola oil, vegetable shortening, vegetable oil or peanut oil are the best options for outdoor grills.
- Season your cooking grates,
 - 1) Before first use
 - 2) Whenever the cooking grates appear dry
 - 3) At first signs of rust or corrosion
- Before each cook, lightly coat your cooking grates with oil, this will help to build layers of seasoning.

DIRECT & INDIRECT COOKING



DIRECT COOKING

This is the most popular cooking method and involves cooking food directly over a lit burner. Foods cooked using this method will include steaks, burgers, chops, and vegetables (see image A).

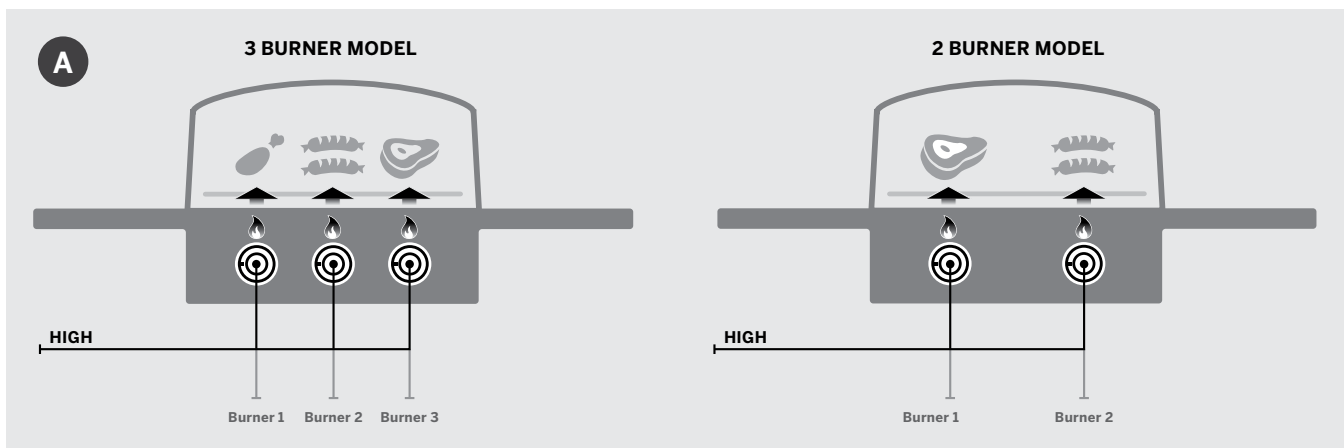

INDIRECT COOKING

This method is ideal for cooking large cuts of meat such as roasts, ribs or poultry. Food is placed on the cooking grates, offset from the heat source and is cooked by the hot air circulating around it. The barbecue lid should always be closed when using the indirect cooking method (see image B).

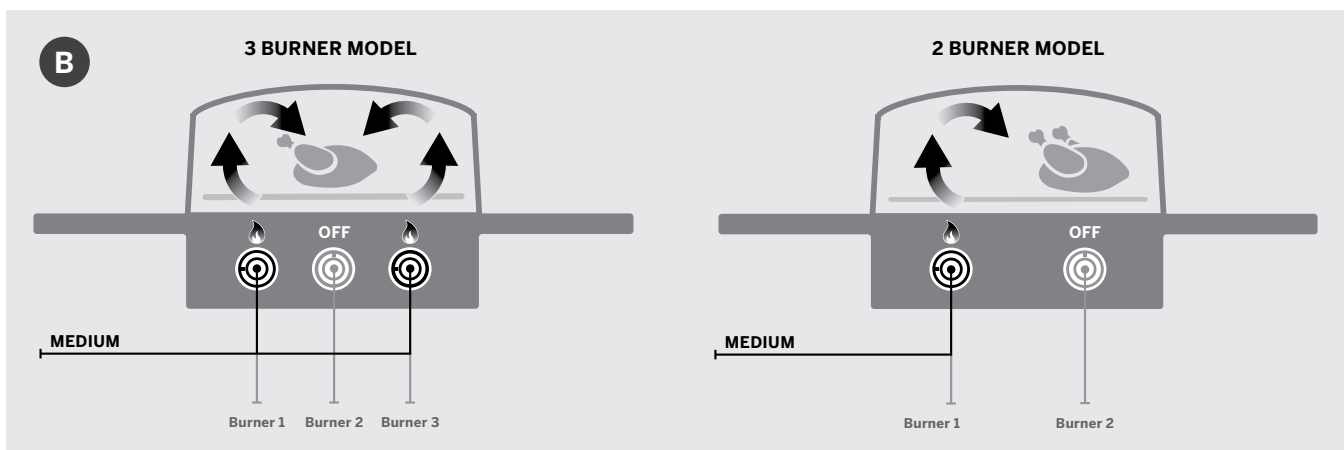

CONTROL SETTINGS

HI - is intended for preheating the barbecue and for searing meats. Most grilling will require the MED setting to avoid overcooking the outside of foods and undercooking the inside.

MED - is intended for most grilling, baking and roasting, including chops, chicken and burgers.

LOW - is intended for warming, slow cooking, smoking or cooking delicate foods.

CONTACT US: 1-844-586-4660

CLEANING YOUR BARBECUE

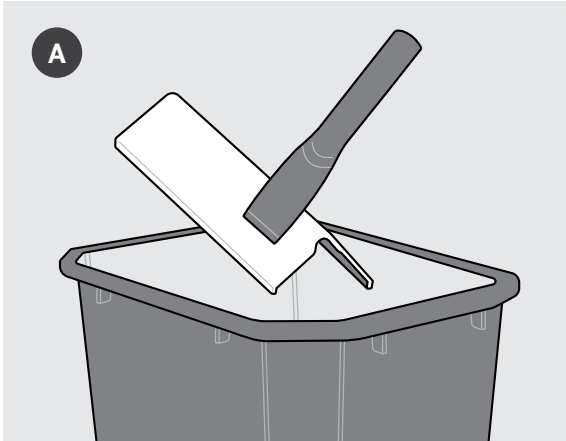

CLEANING THE HEAT PLATES

1. Remove heat plates.
2. Holding your heat plate over a large garbage receptacle, use a plastic paint scraper or a grill brush to remove debris (see image A).

IF A MORE THOROUGH CLEANING IS REQUIRED:

3. Clean away all remaining debris with mild soap and warm water.
4. Dry thoroughly.
5. Re-install.

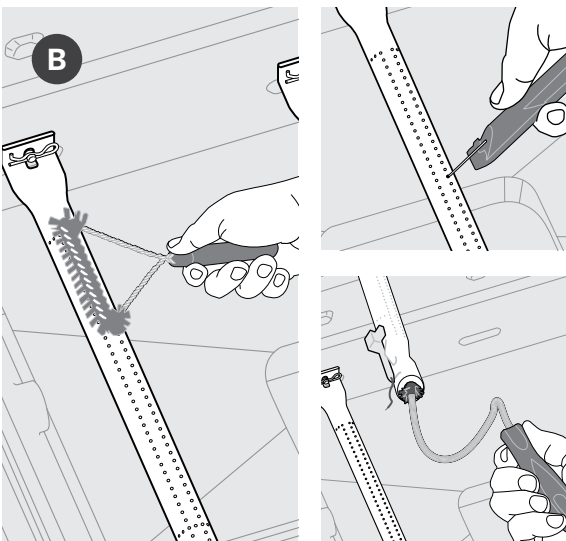

CLEANING THE BURNER

Keeping burners free of blockages including spiders, insects, nests and other debris that can block the burner ports is essential for safe operation.

1. Use a clean grill brush to clean the outside of the burner (see image B).
2. Remove the hitch pins used to secure the burners to the burner box. Use pliers if necessary.
3. Lift burners out slightly, exposing the burner venturi. Be careful not to damage or disconnect the electrode connector.
4. Use a pipe cleaner or flexible Venturi Brush to clean the interior of all burners. Shake any loose debris out of the burner.
5. Use a wire or paper clip to clean burner port holes. Do not use anything that can damage or enlarge port holes.
6. Use a clean soft bristle brush to clean spider/ insect screens.
7. Reinstall, ensuring that the burner orifice is placed over the gas jet correctly.

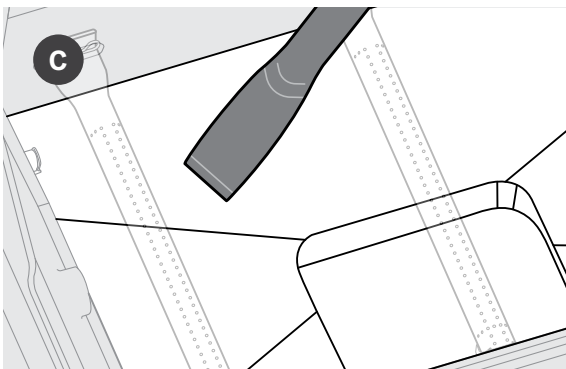

CLEANING THE COOKBOX

Excessive build-up inside the cookbox can lead to grease fires and overheating.

1. Use a plastic scraper to scrape debris off the interior surfaces of the burner box, and into the grease tray liner (see image C).

IF A MORE THOROUGH CLEANING IS REQUIRED:

2. For stubborn build-up use a grill degreaser to loosen up debris and then repeat step 1.

CLEANING YOUR BARBECUE

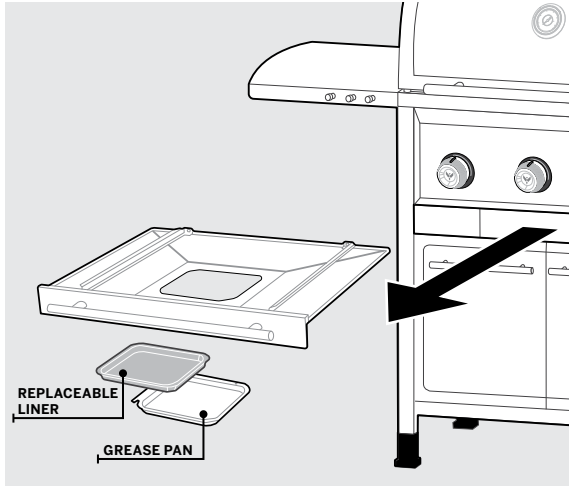

CLEANING THE GREASE COLLECTION SYSTEM

The grease collection system consists of 3 parts: Front access grease drawer, a removable grease pan, and a replaceable liner (Replacement liners are available for purchase at a local Vermont Castings™ Dealer (Model # 085-2169). These components were designed to be quickly and easily removed, cleaned and replaced, on a regular basis to ensure safe operation of your barbecue.

To clean, start by removing the undermounted grease pan and disposable replacement liner from the grease drawer.

CAUTION: KEEP YOUR GREASE COLLECTION SYSTEM FREE OF BUILD-UP. FAILURE TO CLEAN THESE COMPONENTS MAY RESULT IN ELEVATED COOKING TEMPERATURES CAUSING UNEVEN HEAT, AS WELL AS DANGEROUS GREASE FIRES.

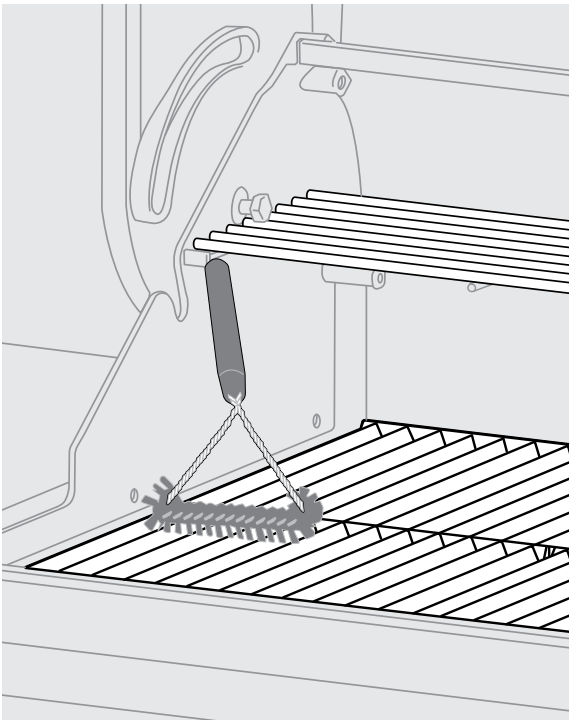

CLEANING COOKING GRATES

1. During preheat, brush cooking grates with a grill brush to remove debris.

IF A MORE THOROUGH CLEANING IS REQUIRED

1. Wash cooking grates with soap and water only.
2. Rinse and dry thoroughly with a towel. If cleaning on a very hot day, allow grates to dry in the sun.

CAUTION: IF YOUR COOKING GRATES ARE PORCELAIN-COATED CAST IRON, ALWAYS HANDLE WITH CARE TO AVOID DAMAGING THE PORCELAIN ENAMEL FINISH.

CLEANING YOUR BARBECUE

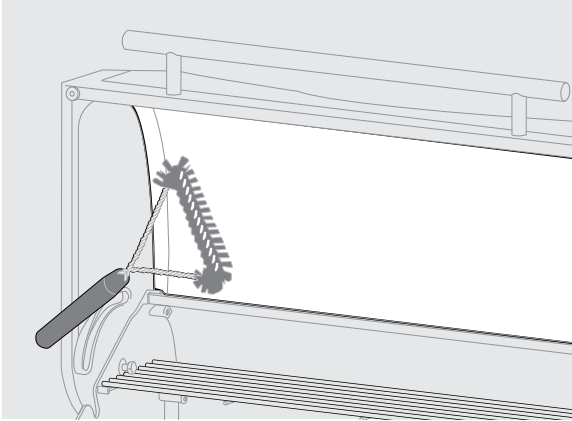

CLEANING THE INSIDE OF THE LID

Over time you may notice “paint-like” peeling on the inside of the barbecue lid. During use grease and smoke vapours turn into carbon deposits, which eventually begin to peel. These deposits are non toxic but should be cleaned off to avoid flakes falling onto food.

1. Use a grill brush to brush the carbon build up from inside the lid on a regular basis to avoid this build-up.

CLEANING THE EXTERIOR STAINLESS STEEL SURFACES

- Always use a non-abrasive, non-toxic stainless steel cleaner designed for outdoor products and barbecues.
- Always use a microfibre cloth to clean in the direction of the stainless steel grain.
- Do not use paper towels as they can scratch the stainless steel finish.
- If you notice a film or leftover residue from your cleaner, rinse thoroughly with water and dry with a microfibre cloth.
- Do not allow any spills from sauces to remain on stainless steel parts.
- Always wipe surfaces immediately following cooking.

CLEANING THE EXTERIOR PAINTED, PORCELAIN ENAMEL SURFACES

1. Clean painted and porcelain-coated surfaces with warm soapy water.
2. After wiping down all surfaces, rinse thoroughly with water.
3. Dry with a soft microfibre cloth.

DO NOT USE ANY CHEMICAL CLEANERS ON PAINTED SURFACES AS THEY COULD STRIP THE PAINT AND PERMANENTLY DAMAGE THE SURFACE, LEAVING IT UNPROTECTED.

STORING YOUR BARBECUE

- **BEFORE YOU STORE IT, REMOVE AND CLEAN ALL COMPONENTS.**
- **SEASON COOKING GRATES WITH VEGETABLE SHORTENING AND WRAP IN A TOWEL BEFORE STORING.**
- **IF STORING FOR A PROLONGED PERIOD, REMOVE THE IGNITER BATTERY TO AVOID CORROSION.**
- **USE A BARBECUE COVER TO HELP PROTECT YOUR BARBECUE.**



TROUBLESHOOTING

PROBLEM	POSSIBLE CAUSES	SOLUTION
Smell of gas.	Cylinder, hose, regulator or manifold connections loose.	Shut off LP tank valve immediately. Perform a leak test and safety check (See page 10).
Burners do not ignite.	The "Flow Limiting Device" feature in your regulator may have been activated.	Reset The "Flow Limiting Device" (See page 11).
Burner flames are low when burner control knob is in the "HIGH" position.	Improper lighting procedure.	Follow proper lighting procedure.
Barbecue Temperature does not go over 300°F (149°C), when in the "HIGH" position.	Poor connection between barbecue and gas source. For LP models - Low Propane. For New Natural Gas models - May have an undersized supply line.	Perform a leak test to identify poor connection. Hand tighten connection, and perform another leak test.
Burners have yellow, smokey, erratic flames, in conjunction with the smell of gas. Hot or melted control knob, or visible flames under control panel (See Flashback Fire).	The burner ports, burner venturi, or burner spider guard is blocked.	Remove and clean burners. See Burner cleaning on page 23.
Ignitor Not Working. Burners not lighting when the ignition button is depressed (No spark). Lighting with a match or lighter is successful.	Ignition Battery is dead. Electrode Wires not connected, or loose. Ignition Button wires not connected, or loose. Ignition malfunction.	Replace battery. Push electrode wires firmly into Electronic ignition box. Reconnect the control panel mounted ignition button wires. Follow, "Match Lighting" procedure (page 15).

TROUBLESHOOTING

PROBLEM	POSSIBLE CAUSES	SOLUTION
Excessive heat, Flare-ups, or Grease Fire.	Excessive grease build-up on key parts.	Thoroughly clean interior cooking system (See page 23-25).
	Cooking on "HIGH" setting, without adjusting temperature control.	Following preheat, always adjust control knobs to lower temperatures.
	Excessive grease build-up in grease collection tray and grease cup.	Thoroughly clean grease collection components (See page 24).
	Covering more than 70% of the cook surface with an oversized topper or cooking sheet, can trap heat causing overheating.	Never cover more than 75% of your cook surface.
	Cooking large quantities of excessively greasy or fatty foods at the same time, or on an already dirty grill	Always thoroughly clean your barbecue before cooking large volumes of food, and trim excess fat.
Inside of lid is peeling - like paint peeling.	NOTE: The interior lid is aluminum and is not painted. Baked-on grease build-up has turned to carbon deposits and is flaking off.	Clean with stiff brush or scraper.
Decreasing heat, "popping sound".	Out of Propane.	Refill LP Tank.
	Burner and/or burner tubes are blocked.	Remove and clean burners. See Burner cleaning on page 23.
Humming or hissing noise from Regulator, may be accompanied by the smell of gas.	Opening Propane tank valve too quickly.	Always open propane tank valve slowly.
	The black rubber seal in the tank valve is missing or damaged.	Return tank to local dealer.
Melting gas supply hose.	The barbecue's gas supply hose and regulator contains a thermal element, that will shut off the flow of gas if temperatures of 240°F to 300°F (115°C-149°C), are reached, melting the supply hose, to disconnect from the LP tank.	Follow minimum clearance of 36" (91 cm) to combustible materials. Do not block barbecue vent holes.
	Poor ventilation caused by inappropriate clearance at the sides and the rear of the barbecue.	
	Overheating caused by high cooking temperatures or grease fire.	Thoroughly clean interior cooking system. (See page 23-25).



WARNING HOT SURFACES

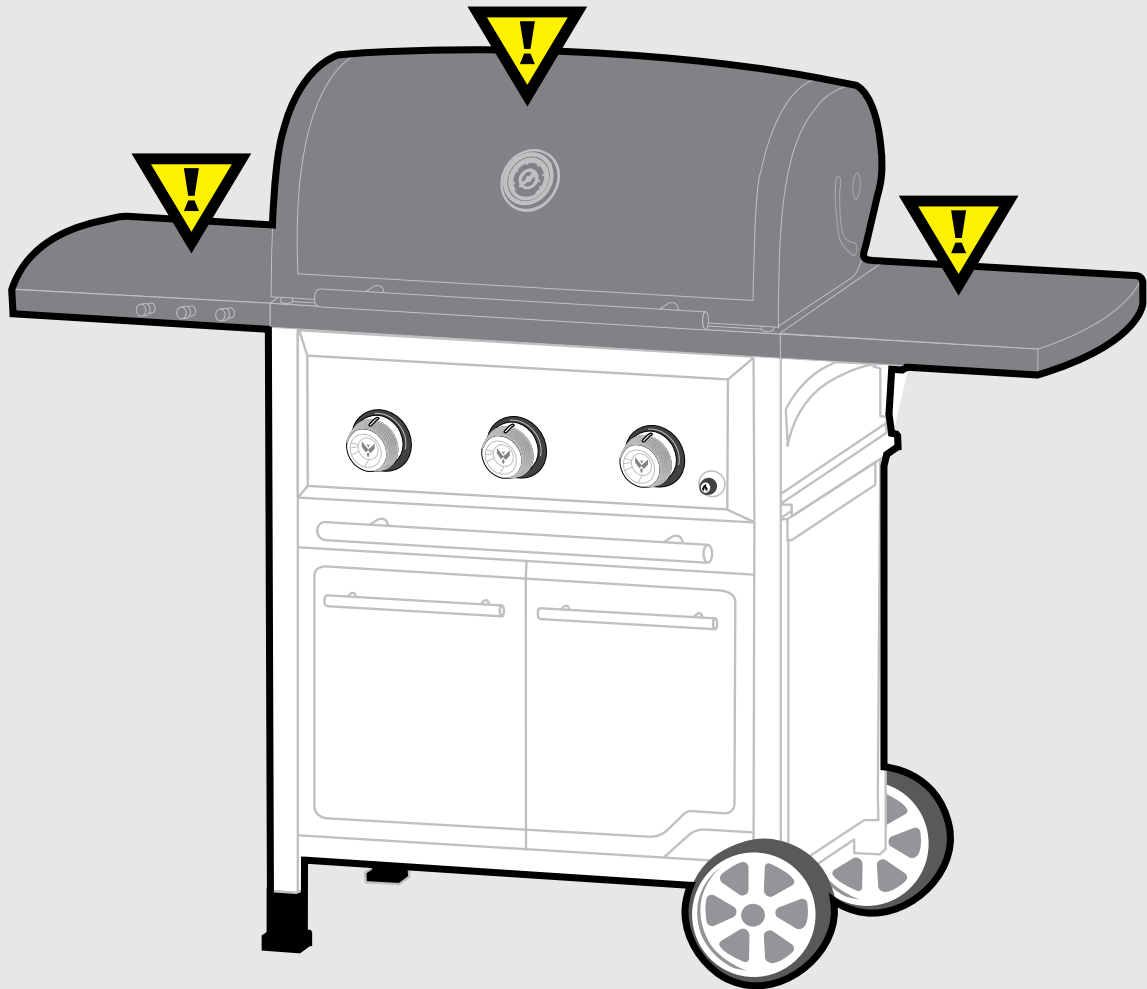

WARNING: EXTERIOR SURFACES WILL BECOME VERY HOT. TO PREVENT BURNS, ALWAYS WEAR INSULATED PROTECTIVE BARBECUE MITTS WHEN WORKING AT THE BARBECUE.

- KEEP AWAY FROM COMBUSTIBLE MATERIALS.
- KEEP CHILDREN AND PETS AWAY FROM THIS GAS-FIRED BARBECUE.
- AVOID DANGEROUS FIRES: DO NOT LEAVE YOUR BARBECUE UNATTENDED WHILE IN OPERATION.

SERVICE

HOW TO CONNECT WITH US

BEFORE YOU CALL FOR SERVICE have the following information available:

- 1. Serial number:** The serial number can be found on the side of the barbecue carton, the cover page of the assembly manual, and on the rating label located on the inside of the cart door.
- 2. Model number:** The model number is located on the cover page of the assembly manual, the bottom right corner of the rating label and also on your cash register receipt.
- 3. Proof of purchase** by the original owner.

IF YOUR PRODUCT IS DAMAGED

Do not return to the store for replacement of damaged or defective parts. Vermont Castings™ Customer Care will ensure that all in-stock replacement parts arrive at your home within 3-10 business days.

Concealed Damage: If damage is unnoticed until merchandise is unpacked, resolve issue by contacting Vermont Castings™ Customer Care immediately. Missing or damaged parts should be claimed **within 30 days of purchase**.

LOCATE YOUR BARBECUE MODEL AND SERIAL NUMBER

Fill out your barbecue details below.

MODEL: _____

DATE OF PURCHASE: _____

SERIAL NUMBER: _____

Call our Vermont Castings™
Customer Support
1-844-586-4660



WARRANTY

WARRANTY RESPONSIBILITIES & LIMITATIONS

WE WARRANT THAT THIS BARBECUE (THE “PRODUCT”) ONLY TO YOU, THE ORIGINAL PURCHASER:

- If this product was a gift or a promotional item, only to the person for whom it was purchased, or received it as promotional item and is not transferable to subsequent owners.
- We warrant the product to be free from defects in material and workmanship for the durations indicated below when operating in accordance with the accompanying owner’s manual.
- We agree to repair or replace the part that is defective in material or workmanship subject to the limitations and exclusions.

VERMONT CASTINGS™ LIMITED WARRANTY*

Top Lid including Cast Iron End Caps (Excluding Paint)	15YRS
Cart Frame (Excluding Paint)	15YRS
Firebox (Excluding Paint)	10YRS
Stainless Steel Burners	10YRS
Stainless Steel Heat Plates	5YRS
All Other Parts & Paint (Excluding Chipping, Scratches, Rust, Discolouration)	2YRS

*Subject to limitations.

OWNER’S RESPONSIBILITIES & LIMITATIONS:

- You must provide us with the original sales receipt and/or invoice for the product when making any claim under this warranty.
- Warranty only applies if you take reasonable care of the product by following all assembly instructions, local/national building and fire codes, usage instructions, and preventative maintenance as outlined in the accompanying owner’s manual.
- If you live in a coastal area, or you have your product located near a pool, maintenance includes regular washing and rinsing of the exterior surfaces as outlined in the owner’s manual.
- To submit a warranty claim or receive support for your product, please call the Vermont Castings™ customer care hotline (1-844-586-4660) or visit us online (VermontCastingsBBQ.com/En/Warranty).

EXCLUSIONS:

The warranty lapses if there are damages, deteriorations, discolorations, and/or rust for which we are not responsible, caused by:

- **Normal Wear & Tear:** Wear & Tear, includes cosmetic and other immaterial deterioration that may come with ownership of your barbecue over time, such as dents/scratches, chipping, discoloration caused by environment or heat, **surface corrosion, rust or rust perforation**, chemical exposure in the atmosphere and other damages which result with normal use and are otherwise uncontrollable by us.
- This warranty applies only when the product is used in Canada.
- **Accidental damage** (not caused by a material defect), abuse, tampering or misuse, alteration, modification, misapplication, vandalism, neglect, careless handling, damages caused by improper assembly or installation, alterations, and clearance to combustible materials.
- Failure to properly perform **regular maintenance**, safety checks and service, including but not limited to removal of insects from venturi tubes, resulting in a flashback fire, damage caused by grease fires, flare-up fires or fires resulting from improper connection of hose to gas source.
- Use of improper cleaning products, such as indoor stainless steel cleaners, abrasive and chemical cleaners, porcelain oven cleaner and other chemical cleaners which can cause damage to surfaces.
- Insects (such as spiders) and rodents (such as squirrels), including but not limited to damage to burners and/or gas hoses.
- Exposure to salt air and/or chlorine sources such as swimming pools and hot tubs/spas.
- Severe weather conditions such as hail, hurricanes, earthquakes, tsunamis or surges, tornadoes or severe storms.
- Acid rain and other environmental factors.
- Use of non-genuine manufacturer parts voids this warranty, and any damages that result hereby are not covered by this warranty.
- Any damages related to improper assembly and conversion of the Product will void this warranty.
- We will not be responsible for the installation, labour or any other costs or expenses related to the re-installation of a warranted part, and such expenses are not covered by this warranty.
- Shipping and handling charges, export duties and any labour costs are your responsibility, including all part orders that are in/out of warranty.

CONTACT US: 1-844-586-4660

WARRANTY

DISCLAIMERS AND PROCESSING/REPLACEMENT PARTS

DISCLAIMERS:

There are no other express warranties except as set forth herein and any applicable implied warranties of merchantability and fitness (or those provided for by law) are limited in duration to the period of coverage of this express written limited warranty.

- No warranties shall apply after the applicable period of this warranty.
- No other warranties given by any person, including a dealer or retailer, with respect to any product (such as any “extended warranties”), shall bind us.
- Upon investigation, we may repair or replace (at our option) a defective part that is covered by this warranty.
- In no event under this voluntary warranty shall recovery of any kind be greater than the amount of the original purchase price of the product.
- **You acknowledge the inherent risks of use of a gas fired appliance and you assume the risk and liability for loss, damage, or injury to you and your property and/or to others and their property arising out of the misuse or abuse of the Product or failure to follow instructions provided in the accompanying owner’s manual.**
- Parts replaced under this warranty are warranted only for the remaining balance of the above mentioned warranty period.
- This warranty applies to personal/recreational outside use only and does not apply to the Product being used in commercial, communal or multi-unit settings such as restaurants, hotels, resorts, or rental properties.
- We may from time to time change the design of our product(s). Nothing contained in this warranty shall be construed as obligating us to incorporate such design changes into previously manufactured product(s), nor shall such changes be construed as an admission that previous designs were defective.
- We do not authorize any person or company to assume for it any other obligation or liability in connection with the installation, use, removal, return, or replacement of its equipment; and no such representations are binding on us.
- This limited warranty will not reimburse you for the cost of any inconvenience, food, personal injury (wherever permissible by law) or property damage.
- We shall not be liable for incidental, consequential, special or contingent damages resulting from its breach of this written warranty or any implied warranty.
- We shall not be responsible for any legal fees or expenses incurred by you in connection with this warranty.

WARRANTY PROCESSING/REPLACEMENT PARTS

- The **original receipt** and/or invoice will be required together with a serial number and a model number when making any warranty claims.
- We reserve the right to have our representative inspect any product or part prior to honouring any warranty claim. The manufacturer may ask you to send parts, or images for inspection.

To submit a warranty claim or receive support for your product, please call the Vermont Castings™ customer care hotline: 1-844-586-4660 or visit us online (VermontCastingsBBQ.com/En/Warranty).

NOTES

NOTES



**VERMONT
CASTINGSTM_{MC}**



CONTACT US: 1-844-586-4660
WWW.VERMONTCASTINGSBBQ.COM