

This Owner's Manual is provided and hosted by [Appliance Factory Parts](#).



# Vision Grill XD702 Owner's Manual

[Shop genuine replacement parts for Vision Grill XD702](#)



[Find Your Vision Grill Grill Parts - Select From 25 Models](#)

----- Manual continues below -----

# VISION GRILLS™ XR702 DELUXE OWNER'S MANUAL

## WELCOME

Welcome to Kamado cooking! Our Vision Grills Kamado is based on 3,000+ years of clay pot cooking from around the world. Over generations our ancestors have continued to refine Kamado techniques for grilling, smoking, baking and cooking all types of meats, poultry, fish and vegetables. Kamado cooking locks in moisture and provides a variety of ways to infuse different tastes into your foods that turns weekend grillers into neighborhood chefs.

Our Vision Grills Kamado builds on this heritage with fresh aesthetics, safety and convenience features, easy-lift lid with spring assist and high quality materials to define a new industry standard for design and innovation. The thick ceramic construction of our grill provides superior thermal insulation allowing you to grill, cook, bake or smoke regardless of the season, from the hot summer days in our home town of St. Louis to the cold snowy days in Ottawa, Canada.

In this manual we provide the basics to get you cooking and invite you to our website, [www.visiongrills.com](http://www.visiongrills.com), where we share recipes, detailed Use & Care information and contact information if you need more help. From our entire team here at Vision Grills, thanks for your purchase and welcome to becoming the destination eatery in your neighborhood!



## Cooking with your Kamado

Your new Vision Grills Kamado is the complete outdoor cooking appliance that allows you to sear, grill, bake and smoke all types of food. For best results, we recommend using natural lump charcoal made from hardwoods. Compared to briquettes, natural charcoals start faster, burn cleaner and longer, reach higher temperatures and produce less ash. Left-over natural charcoal also relights for re-use. Before re-starting the grill, knock off excess ashes to any remaining charcoal. Routinely empty ashes, but only empty ashes when grill is cold.

Starting your Vision Kamado Grill is simple and fast: Open grill lid, open top and bottom vents wide open, fill the inner fire bowl with enough charcoal to just cover the air holes, then light the charcoal using either an electric starter or approved grill starters. After several coals are burning, spread evenly, close lid, adjust top and bottom vents, and wait for the Kamado to reach your desired cooking temperature. As needed, add more charcoal by using the flip grate feature, being careful not to burn yourself with the hot food or cooking grate.



## WARNING

REMEMBER TO REGISTER YOUR GRILL WITHIN 30 DAYS OF PURCHASE AT [HTTPS://VISIONGRILLS.COM/RESOURCES/REGISTER-YOUR-GRILL](https://www.visiongrills.com/resources/register-your-grill)

ATTENTION! Use caution when cooking, as grill surfaces get hot. To avoid burns, always use protective gloves to adjust top and bottom vents when grill is in use. Do not wear loose clothing near the grill.

ATTENTION! This barbecue will become very hot, do not move it during operation. For outdoor cooking use only. Do not operate grill indoors or in an enclosed space. Use grill only in well-ventilated areas. Keep immediate area around the grill free from combustible materials. Allow for at least 3 feet/1 meter of clearance around grill (house, other outdoor products, hanging tree limbs, shrubs, etc.)

WARNING! Keep children and pets away from the grill at all times.

Do not allow children to operate grill. Never leave grill unattended when in use.

Grill should be placed securely on a level base prior to use. Only operate grill on a hard, stable, level surface (concrete patio, ground, etc.) capable of supporting the weight of the grill when loaded with food. Never operate grill on wood support surface, wood deck or like combustible support surfaces. Never attempt to move grill when in operation or cooling down. Never operate this grill within 25 feet/7.5 meters of any flammable liquid. Never operate this grill within 10 feet/3 meters of a gas cylinder. The grill should not be placed under combustible structures, like garages, porches, patios, or carports. Burning charcoal produces carbon monoxide, an odorless gas, which can cause death.

The use of alcohol, prescription or non-prescription drugs may impair the operator's ability to properly assemble or safely operate the grill.

Do not use on boats or recreational vehicles.

CAUTION: Never use lighter fluid, gasoline, or other volatiles to start your charcoal, as it is dangerous and will leave a residual taste in your food. NEVER use Charcoal Briquettes that contain starting chemicals or additives. Use only firelighters complying to EN 1860-3. Use utmost care when adding charcoal to grill. Dispose of cooled ash by placing it in aluminum foil, soaking with water and discarding in a non-combustible container. Always wait for grill to completely cool before opening built-in ash drawer.

CAUTION: WAIT FOR GRILL TO BE COMPLETELY COOLED BEFORE PLACING COVER ON GRILL. NEVER PLACE COVER ON GRILL THAT IS HOT OR WARM.

When cooking above 500°F/260°C, with both top and bottom vents closed, rapidly opening the lid creates a sudden rush of oxygen into the grill, which can cause a flare-up. When in this cooking mode, we recommend that, prior to opening the lid, you open top and bottom vents to allow oxygen to stabilize inside the grill, minimizing the possibility of a flare-up.

If using for outdoor kitchen, table, or enclosure a lava stone or paving stone must be placed between bottom of grill and resting surface. Do NOT rest ceramic grill body on wooden surface.

### Long-Term Maintenance

1. When moving your grill please remember to make sure locking casters are in the unlocked position and always pull your grill. Never Push it. Pull from the Back Hinge. Not the Handle. Your grill is more likely to tip if you push it and it hits a bump or indentation on the ground.
2. Do not remove your Fire Bowl. Clean ash by brushing excess ash into ash drawer and removing. The purpose of the Fire Bowl is to hold your lump charcoal and will continue to work even if it is cracked.



**WARNING:** FUELS USED IN WOOD OR CHARCOAL BURNING APPLIANCES, AND THE PRODUCTS OF COMBUSTION OF SUCH FUELS, CAN EXPOSE YOU TO CHEMICALS INCLUDING CARBON BLACK, WHICH IS KNOWN TO THE STATE OF CALIFORNIA TO CAUSE CANCER, AND CARBON MONOXIDE, WHICH IS KNOWN TO THE STATE OF CALIFORNIA TO CAUSE BIRTH DEFECTS OR OTHER REPRODUCTIVE HARM. For more information go to: [www.P65Warnings.ca.gov](http://www.P65Warnings.ca.gov).

**ADVERTENCIA:** LOS COMBUSTIBLES USADOS EN EQUIPOS PARA QUEMAR MADERA O CARBÓN, ASÍ COMO LOS PRODUCTOS DE TAL COMBUSTIÓN, PUEDEN EXPONERTE A SUSTANCIAS QUÍMICAS, ENTRE ELLAS EL NEGRO DE HUMO Y EL MONÓXIDO DE CARBONO, QUE EL ESTADO DE CALIFORNIA RECONOCE COMO CAUSA, RESPECTIVAMENTE, DE CÁNCER Y DE MALFORMACIONES CONGÉNITAS Y OTROS DAÑOS AL SISTEMA REPRODUCTOR. Para más información, visite [www.P65Warnings.ca.gov](http://www.P65Warnings.ca.gov)

# SET-UP

## Step 1: Cart Assembly

- Remove bolts, washers and locking washers from the three "X" connectors.
- Remove paper washers and begin assembling the "X" connectors and legs.
- Please Note: Top, Middle & Bottom "X" connectors must be assembled simultaneously.
- Assemble cart by inserting the three "X" connectors into leg ends and install bolts and washers in the same order they were removed from "X" connectors.
- While assembling, only finger-tighten bolts to allow for adjustment in cart. Otherwise it can be difficult to get all the bolts inserted.
- Screw in Standard Rubber Wheels to rear Cart Legs and the Locking Rubber Wheels to the front Cart Legs.
- Once Cart is assembled, flip cart over so that bolts are exposed.

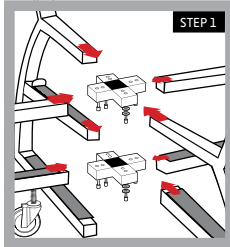

## Step 2: Electric Starter Holster

**Step 2a:**

- Loosen the (4) outer bolts slightly so as to allow for the Holster body to slide into the gap between the bolt heads and the leg bars.

**Step 2b:**

- With opening of Holster facing the front of the cart (the Locking Wheels) slide toward the rear of the cart. Then slide the holster back into place.

**Step 2c:**

- Using provided T-Handle Wrench, tighten bolts again through hole openings in bottom of Holster.
- Once Holster is secure, flip cart back over to proper position so that it is resting on Wheels. Continue Grill Assembly.

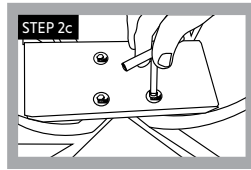
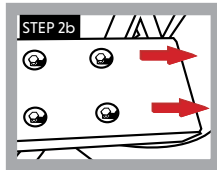
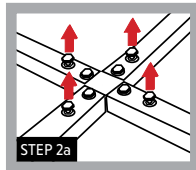

Shown here is the bottom of the cart, flipped upside down

## Step 3: Handle and Side Shelves

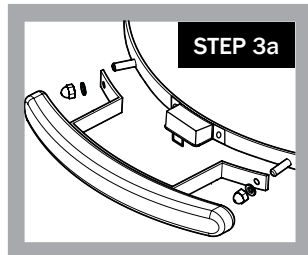

**Step 3a:**

- Remove nuts and washers from bolts welded on the top banding opposite the hinge.

- Remove paper washers and attach handle bracket over studs. On each stud place a flat washer and an acorn nut, then tighten.

**Step 3b:**

- Remove the nuts and washers from the bolts welded on the bottom banding carefully. Remove the paper washers.

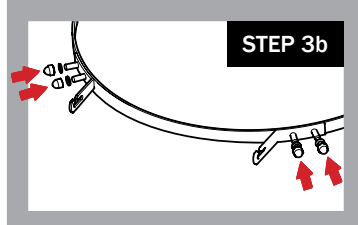

- Place the side brackets on the bolts and screw side brackets down tightly with the nuts and washers. Mount shelf brackets over studs on the sides of the metal bands on the bottom ceramic grill body with bracket slots facing up. Brackets are stamped on the back with letters indicating their position (e.g., LF=Left Front bracket and RB=Right Back bracket).

- Mount a flat washer then acorn nut on each stud and tighten with provided wrench.
- Mount side shelves by inserting the shelf rod into the shelf bracket. Tilting the shelf up slightly and sliding in or out allows you to deploy or store the shelves.

## Step 4: Grill Assembly

- Take all parts out of grill before lifting. The grill is heavy and will require two people to lift and guide the Kamado into cart.
- Be sure the Ash Drawer is centered between the two front legs and the grill is resting against the two back legs.
- Lower fire bowl into grill with the ash drawer opening lined up with the opening in the main ceramic body. Place cast iron charcoal grate with attached starter pocket into fire bowl (**Step 4a**). Align tabs of starter pocket with electric starter port in fire bowl.

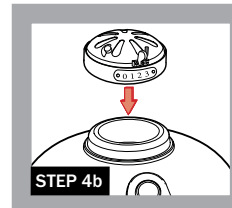
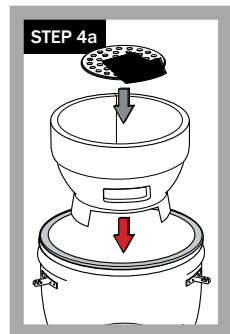

- Place cooking grate onto grill with hinged section facing towards front of grill.
- Close lid and press top vent onto grill with calibrations facing the front (**Step 4b**).

**ATTENTION:** THE KAMADOMATIC™ HINGE WILL CAUSE THE TOP LID TO JUMP SLIGHTLY WHEN PULLING ON THE LATCH BUTTON.

## Step 5: Lava Stone & Bracket Assembly

- Open grill and take off grill grates to expose fire bowl.
- Spread bracket so it makes an "X" shape and lower onto fire bowl, allowing the bracket to rest on edge of bowl.
- Lower Lava Stone onto the bracket.

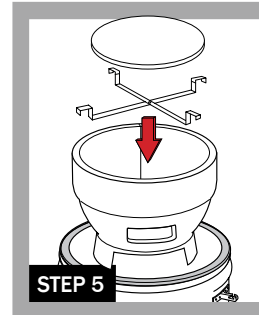

## Step 6: Ash Drawer Usage

- Once grill is cool, it is safe to remove ash from ash drawer.
- Using bottom knob on Ash Drawer, lift slightly (**Step 6a**) and pull drawer out (**Step 6b**).
- Once ash is emptied, reinstall by pushing Ash Drawer back into grill body until it drops down back into place.

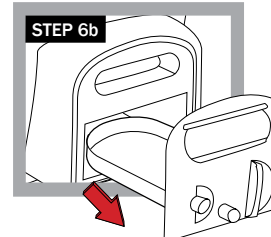
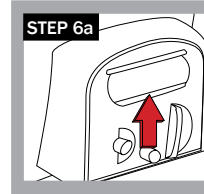

**WARNING: ALWAYS WAIT FOR ASH TO COOL BEFORE REMOVING ASH DRAWER. NEVER PULL OUT ASH DRAWER WHILE GRILL IS HOT.**

## Step 7: KamadoMatic™ Hinge Adjusting

The KamadoMatic™ Hinge on your Pro Kamado is already pre-adjusted for ideal balance and stability. Follow these instructions to manually adjust the hinge further to your preference.

**CAUTION:** KamadoMatic™ Hinge under high tension.

- Open the dome of your Pro Kamado.
- While holding the top dome open with one hand, use the provided 13mm wrench to adjust the Spring Nut as shown in (Step 8).
- If the top dome jumps up too quickly upon opening, turn the Spring Nut Counter Clockwise to loosen the spring and reduce tension. Turn the Spring Nut for two turns at a time and test the lid for your preference. The Spring Nut can also be turned Clockwise to tighten the spring and add tension, if necessary.

**NOTE:** Depending on the amount of resistance and tightness of seal it may be necessary to use a small amount of force to lock the lid and have the lock handle slide into the latch. Be careful not to slam the top lid shut.

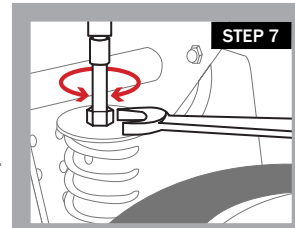

**WARNING: PERFORMING MANUAL ADJUSTMENTS TO THE HINGE CAN CAUSE UNEXPECTED MALFUNCTION OR DAMAGE IF THESE STEPS ARE NOT FOLLOWED CORRECTLY.**

## Rotation Set Screw Adjustment

If the Lid is not staying open during operating the grill and it is too hot to reach in and adjust the Spring you can use the Rotation Set Screw located on the rear of the KamadoMatic™ Hinge Housing.

Open the ceramic lid all the way to the top, and then tighten the Rotation Set Screw by turning it clockwise until you reach your desired tension. This will conveniently allow you to adjust the lid tension until it is safe to adjust the Spring.

### Important Notice and Reminder:

This Rotation Set Screw adjustment is a temporary solution. When you are done grilling and the grill cools down, loosen the Rotation Set Screw, and proceed to the Hinge adjustments detailed in Step 7.

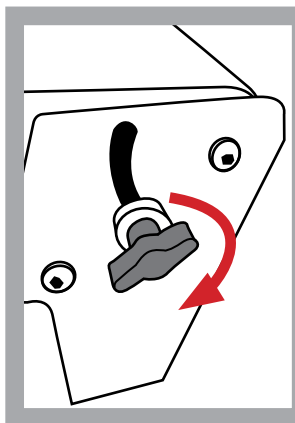

www.visiongrills.com  
help@visiongrills.com

Vision Grills 1531 Fairview Avenue, Suite B,  
St. Louis, MO 63132

1-877-917-4273

# PARTS

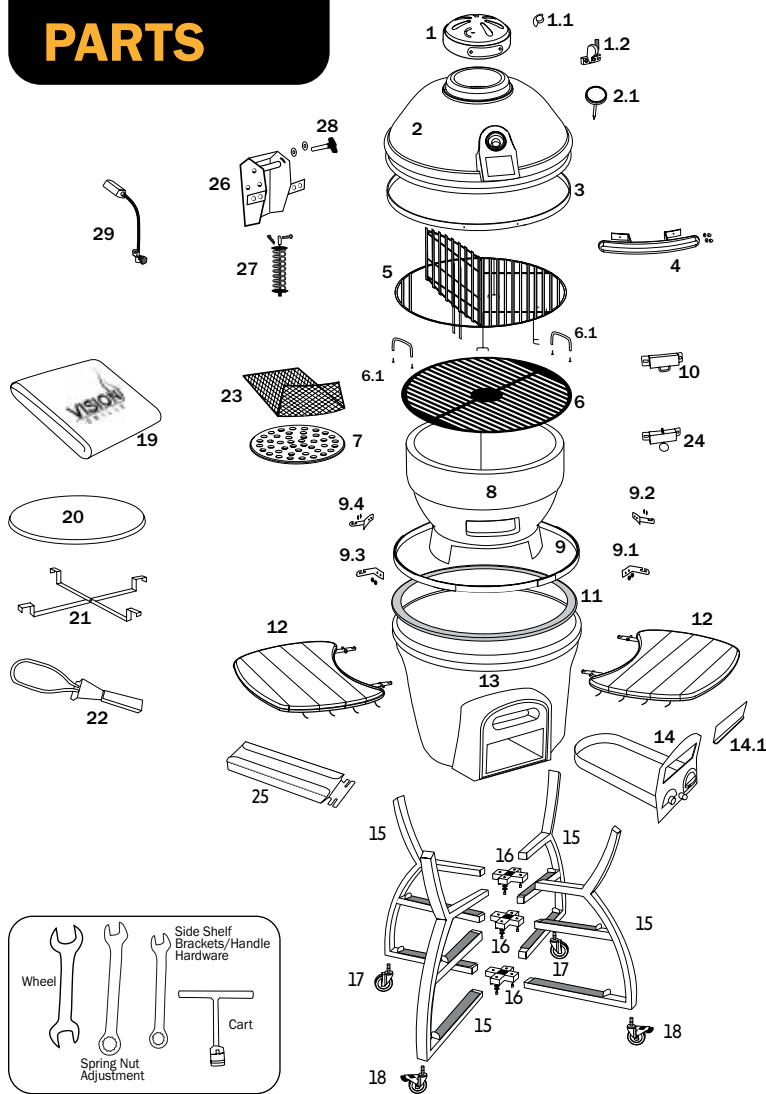

## PART NAME

PART NAME	PART NUMBER	
1	Cast Iron Top Vent	VGCTV-CA-SP
1.1	Smoker Knob	VGKP-C SK
1.2	Bakelite Tab with Stopper Pin	VGCTV-CA-TSP
2	Ceramic Dome Lid	VGC CDL-2
2.1	Thermometer	VGC IT
3	Top Ring Assembly	VGC RA1-L
4	Handle (with nuts & washers)	VGC HDL-L
5	Top Cooking Grate, Stainless Steel	VGC CGT-L
6	Cooking Grate, Cast Iron	VGC CIGGB-L
6.1	Handle for Cast Iron Grate (with bolts) (x2)	VGC CGB-H
7	Charcoal Grate	VGC CG-L
8	Fire Bowl	VGC FB-1
9	Bottom Ring Assembly	VGC RA2
9.1	Right Front Side Shelf Bracket (with nuts & washers)	VGC SB-RF
9.2	Right Back Side Shelf Bracket (with nuts & washers)	VGC SB-RB
9.3	Left Front Side Shelf Bracket (with nuts & washers)	VGC SB-LF-L
9.4	Left Back Side Shelf Bracket (with nuts & washers)	VGC SB-LB-L
10	KamadoMatic™ Latch (TOP)	VGC KML-T
11	Felt Gasket	VGC KMFLT-L
12	(x2) Wood-Sculpted Thermoplastic Side Shelves with Accessory Hooks	VGC WS-RR
13	Ceramic Dome Bottom	VGC SSDB-L
14	Ash Drawer Body	VGC ADB-PC
14.1	Bottom Draft Door Frame	VGC ADB-PCFD-L
15	Cart Leg, Curved, Stainless Steel (x4)	VGC CLEG-SS+
16	"X" Leg Connectors (with bolts, washers & spring washers)	VGC XLC-L
17	Rubber Wheels (x2) Standard	VGC WHL-L3
18	Rubber Wheels (x2) Locking	VGC WHL-S3
19	Grill Cover	VGC GC-L
20	Lava Stone	VGC-101R
21	SS Stone Bracket	VGC-BRACKET
22	Electric Starter	VGC-ELEC
23	Electric Starter Pocket	VGC ESP-1
24	KamadoMatic™ Latch (BOTTOM)	VGC KML-B
25	Holster for Electric Starter, Stainless Steel	VGC HOLST-SS
26	KamadoMatic™ Housing Box	VGC KMHB-1
27	KamadoMatic™ Spring Assembly	VGC KMSA-MS
28	Rotation Set Screw	VGC KM-RSS
29	Flexible Grill Light, Black	VGC FGL-K

## WARRANTY

**REMEMBER TO REGISTER YOUR GRILL WITHIN 30 DAYS OF PURCHASE AT [HTTPS://VISIONGRILLS.COM/RESOURCES/REGISTER-YOUR-GRILL](https://visiongrills.com/resources/register-your-grill)**

Remember to Register your Grill at [www.visiongrills.com/register](http://www.visiongrills.com/register). Subject to the following terms and conditions, Phase 2, LLC, d/b/a Vision Grills ("Vision Grills"), warrants to the original purchaser that the ceramic cooker manufactured or supplied by Vision Grills will be free from defects in material and workmanship under normal use for the following periods from the original date of purchase: limited lifetime for all ceramic parts, five (5) years for all metal parts, three (3) years for thermoplastic handle and side shelves, one (1) year for temperature gauge, gaskets and cover, 90 days for lava stone & bracket. This Limited Lifetime Warranty is contingent upon purchaser registering the product at [www.visiongrills.com/register](http://www.visiongrills.com/register) within 30 days from the date of purchase along with a copy of the original dated sales receipt, which can be attached in an electronic format (i.e. scan, photograph, etc.) to an email sent to [help@visiongrills.com](mailto:help@visiongrills.com). Failure to do so will invalidate the warranty. Any chips or cracks in the finish of the ceramic cooker present at the time of purchase must be noted on the original dated sales receipt. This Warranty is not transferable to subsequent owners. If you cannot register online, contact Vision Grills customer service at (877) 917-4273 or email [help@visiongrills.com](mailto:help@visiongrills.com).

If any product covered by this Warranty is defective due to a covered warranty condition, such product will, at the option of Vision Grills, be repaired to its original condition or replaced with a comparable new product or part. The repair and/or replacement of parts shall constitute the extent of the liability and obligations of Vision Grills under this Warranty. Purchaser is required to provide photographic evidence to assess the damage when submitting claims.

Scratches, cracks, chips, dents, crazing, or minor cosmetic blemishes of the exterior glaze not affecting performance are not covered under warranty, as determined by Vision Grills.

This Warranty does not cover damages caused by improper assembly, improper care, failure to follow directions of use, misuse, abuse, negligence, extreme environmental conditions, normal wear and tear, accidents, acts of nature, or unauthorized repair, alteration or modification, as determined by Vision Grills. This Warranty does not apply to chips or cracks in the ceramic cooker which may occur after the ceramic cooker is purchased by the original purchaser. Vision Grills is not liable for any default or delay in its performance under this Warranty that is caused by any circumstances beyond its control. This Warranty will be invalidated if any liquids, including starter lighter fluid, are poured on or in the ceramic cooker. The protective coating of the ceramic cooker can be compromised by substances or conditions that are beyond the control

of Vision Grills. While Vision Grills uses rust-resistant materials, the Warranty as to metal parts does not cover rust or oxidation unless the structural integrity of the ceramic cooker is compromised as determined by Vision Grills.

This Warranty does not cover purchases from unauthorized resellers and/or third parties. Warranty coverage is limited to products purchased at an authorized reseller only.

Commercial use and related applications are not covered under this Warranty. Warranty coverage is based on normal residential use and maintenance.

Vision Grills shall not be liable for any delay or default under this Warranty caused by any event or contingency beyond the control of Vision Grills. This includes acts of nature, fire, government restrictions or restraints, strikes, reduced supply of material or transportation delays.

THIS WARRANTY IS THE EXCLUSIVE WARRANTY OF VISION GRILLS. VISION GRILLS EXPRESSLY DISCLAIMS ANY AND ALL OTHER WARRANTIES, EXPRESS OR IMPLIED, INCLUDING WARRANTIES OF FITNESS, MERCHANTABILITY, OR FITNESS FOR A PARTICULAR PURPOSE. THIS WARRANTY DOES NOT COVER, AND VISION GRILLS IS NOT LIABLE FOR, ANY DAMAGES RELATING TO LOSS OF TIME, LOSS OF USE OF EQUIPMENT, INCONVENIENCE, OR ANY INCIDENTAL, SPECIAL AND/OR CONSEQUENTIAL DAMAGES. PURCHASER'S EXCLUSIVE REMEDY FOR BREACH OF THIS WARRANTY SHALL BE LIMITED AS SPECIFIED HEREIN TO REPLACEMENT OR REPAIR OF THE AFFECTED PRODUCT.

Some states do not allow limitations on how long an implied warranty lasts or the exclusion or limitation of incidental or consequential damages, so the above limitations and exclusions may not apply to you. This Warranty gives you specific legal rights, and you may also have other rights which vary from state to state. Vision Grills does not authorize any person or entity to assume any obligation or liability on its behalf in connection with the sale and purchase of any of its products. The purchase of any Vision Grills product from anyone other than Vision Grills or an authorized dealer will void the Warranty associated with the product. If you have a question regarding the identity of an authorized dealer, you should contact Vision Grills before you purchase the product.

To submit a warranty claim, the original purchaser or authorized agent of the original purchaser must contact Vision at (877) 917-4273 or contact Vision Grills via email ([help@visiongrills.com](mailto:help@visiongrills.com)) or through the website at [www.visiongrills.com](http://www.visiongrills.com).

# STARTING

## Step 1: Measuring Charcoal

Set bottom vent wide open and open lid. Measure out the amount of charcoal needed. For grilling foods fill the fire bowl with enough charcoal to just cover the air holes. Do not exceed 3.5 qt. (1.67 kg) of charcoal. For smoking foods at low temperatures for longer periods of time (1.5 hours+) you may need to add a little more charcoal, up to approximately 2" (50 mm) above the same air holes. Use lump charcoal for best results.



## Step 2: Starting Charcoal

Keep lid open. Open the electric starter flipper door and insert starter as far as possible then plug in. Wait until edges of charcoal turn white and flames are licking the mound of charcoal. It takes approximately 8 - 12 minutes to start the charcoal. After coals are started, unplug electric starter and remove from Starter Door. Be careful when removing as the element will be very hot. Store in Holster and cool completely away from children.



**NOTE:** Do not plug the electric starter in while it is raining unless you're in a safe and securely covered area.

## Step 3: Setting Temperature

When charcoal is ready level it out for even heat distribution. Close the lid. Set the top and bottom vents to the desired setting by referring to the Setting Temperature section in this manual that tells what number calibrations to use to attain the cooking temperature you want. Give your kamado 5-15 minutes to settle into the cooking temperature you want before you put food on the grill.

**NOTE:** If smoking, do not bring your temperature up above 200°F/93°C.

A) Spread hot charcoal evenly over grate.

A



B) Set top and bottom vents for cooking.

B



Top Vent

C) Let temperature stabilize.

C



Bottom Vent

## Step 4: Get Cooking

Use a wire grill brush to clean the cooking grate. That's it - you are ready for the cooking experience of your life. Go to our website for recipes.

### PREVENT FLARE-UPS:

TO EXTEND THE LIFE OF THE FELT, MAKE SURE TO AVOID FLARE-UPS BY "BURPING YOUR GRILL".

If the lid is lifted too quickly, oxygen will rush inside the grill causing a flare-up. To prevent a flare up, lift the lid 1"/25mm and count to three before fully opening the grill. This method is called "Burping your Grill."

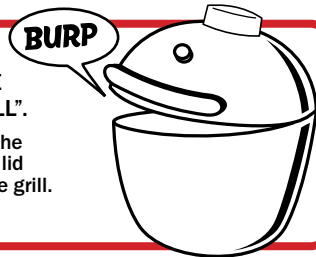

# SETTING TEMPERATURE

**VISION Grills Kamado cooking temperatures are controlled by adjusting the calibrated top and bottom vents.**

Experiences may vary depending on your environment, temperature, wind flow, etc. We suggest grilling initially with the Kamado for 5-6 times to get past the learning curve of your grill, in your environment. The top vent plays a big role in regulating temperatures and putting out fuel. Your grill is properly seasoned when it has a buildup of creosote on the ceramic and top vent.

\*Caution - Decide if you're cooking low and slow, then do not let the grill get too hot. Keep the temperature low, it takes hours to cool down.

Increasing air flow through top and bottom air vents increases cooking temperature, just as decreasing air flow slows the burn and lowers the cooking temperature. Closing both top and bottom vents starves the charcoal of oxygen and shuts down the fire.

\*Caution - Continuous grilling at extreme high temperatures will cause the felt to burn.

	TOP VENT	BOTTOM VENTS
<b>SEARING</b>	 500° + F 260° + C	
<b>GRILLING</b>	 300° - 450°F 149° - 233°C	
<b>SMOKING</b>	 225° - 250°F 107° - 221°C	

All cooking times are approximate.

# COOKING TEMPERATURE

## SMOKING

	Approximate Cooking Time	Smoker Temp (°F)	Meat Temp. (°F)
<b>BEEF</b>			
Brisket (8 - 12 lbs)	1.5 hours/lb	225 - 250	185 - 205
Short Ribs	5 hours	225 - 250	Pulls back from bones
Tenderloin (3 - 4 lbs)	1-4 hours	225 - 250	120 - 160
<b>PORK</b>			
Baby Back Ribs (1.5 - 2.5 lbs)	5 hours	225 - 250	Pulls back from bones
Shoulder / Butt (6 - 8 lbs)	1.5 hours/lb	225 - 250	170 - 205
Ham (Bone In)	1.5 hours/lb	225 - 250	160
Spare Ribs (2.5 - 3 lbs)	5 - 7 hours	225 - 250	Pulls back from bones
Tenderloin (1.5 - 2 lbs)	2.5 - 3 hours	225 - 250	160
<b>POULTRY</b>			
Turkey (Whole)	15 - 20 min./lb	240 - 275	170
Chicken (Whole: 2.5 - 4.5 lbs)	2.5 - 4 hours	250 - 275	170

## GRILLING (350 - 450 °F)

	Beef Temp (°F)	Pork Temp (°F)
Rare	125 + 3 min. Rest	—
Medium-Rare	130 - 135	145 + 3 min. Rest
Medium	135 - 140	150
Medium-Well	140 - 150	155
Well-Done	155+	160+
Ground	160	160
<b>Poultry Temp (°F)</b>		
Dark Meat	165 - 175	
White Meat	165	
Ground	170 - 175	